



NATIONAL INVENTORY REPORT 2023 PORTUGAL

SUBMITTED UNDER THE UNITED
NATIONS FRAMEWORK
CONVENTION ON CLIMATE
CHANGE

Amadora,
April, 15th 2023





Technical Reference

Title	PORTUGUESE NATIONAL INVENTORY REPORT ON GREENHOUSE GASES, 1990-2021 SUBMITTED UNDER THE UNITED NATIONS FRAMEWORK CONVENTION ON CLIMATE CHANGE
Edition	Portuguese Environment Agency
Date	15th April 2023
Place	Amadora

Lead Authors

Teresa Costa Pereira	General Chapters and Cross-Cutting Issues / Waste
André Amaro	Energy/ Transports
Mónica Borges	Transports
Rita Silva	Industrial Processes and Product Use / Energy
Tiago Seabra	Agriculture
Paulo Canaveira	Land Use, Land Use Change and Forestry



To obtain a copy of this report, the Common Reporting Format (CRF) tables or any other information concerning methodologies, activity data or emission factors, and also to send comments and suggestions, please contact:

Agência Portuguesa do Ambiente, I.P.
Departamento de Alterações Climáticas (DCLIMA)
Rua da Murgueira-Zambujal
2610-124 Amadora – PORTUGAL
tel:+351 21 472 00 00 fax:+351 21 471 83 82
e-mail: geral@apambiente.pt
<http://www.apambiente.pt>



Acknowledgements

The authors wish to express their appreciation to the Focal Points and the Involved Entities of the National System (SNIERPA) who have participated in the preparation of the Inventory, for their contribution with data, technical advice and to the continuous improvement of the inventory, in particular:

ANAC – Autoridade Nacional da Aviação Civil

APA/DRES – Agência Portuguesa do Ambiente / Departamento de Resíduos

APA/DRH – Agência Portuguesa do Ambiente / Departamento de Recursos Hídricos

DGAE – Direção Geral das Atividades Económicas

DGEG – Direção Geral de Energia e Geologia

DRAAC-A – Direção Regional do Ambiente e Alterações Climáticas / Secretaria Regional do Ambiente e Alterações Climáticas / Região Autónoma dos Açores

DRAAC-M – Direção Regional do Ambiente e Alterações Climáticas / Secretaria Regional do Ambiente, Recursos Naturais e Alterações Climáticas / Região Autónoma da Madeira

EDP – Energias de Portugal

GEE-ME – Gabinete de Estratégia e Estudos / Ministério da Economia e Mar

GPP – Gabinete de Planeamento, Políticas e Administração Geral / Ministério da Agricultura e Alimentação

IAPMEI - Agência para a Competitividade e Inovação

ICNF – Instituto da Conservação da Natureza e das Florestas

IFAP – Instituto de Financiamento da Agricultura e Pescas

IGP – Instituto Geográfico Português

IMT – Instituto da Mobilidade e dos Transportes

INE – Instituto Nacional de Estatística

INIAV – Instituto Nacional de Investigação Agrária e Veterinária

IST – Instituto Superior Técnico

REN – Redes Energéticas Nacionais

The authors also wish to express their appreciation to other Institutions whose contribution has been highly relevant to this report: ACAP, Aldifrio, Air Liquide, Brenntag, Cimpor, Filipe Bela, Gasin, Infarmed, Secil, APIGRAF, EuPIA, ESIG, TENSAL.



Preface

The Portuguese Environment Agency (*APA - Agência Portuguesa do Ambiente*) / Portuguese Ministry of Environment and Climate Action (*Ministério do Ambiente e da Ação Climática*), in accordance to its attributions as national entity responsible for the overall coordination and reporting of the Portuguese inventory of air pollutants emissions, prepares each year the National Inventory of Greenhouse Gas (GHGs) Emissions and Sinks in order to comply with the international commitments under the United Nations Framework Convention on Climate Change (UNFCCC) and the European Union.

This report aims to comply with the international commitments under the UNFCCC and the European Commission (EU), taking into account the Revision of the UNFCCC reporting guidelines on annual inventories for Parties included in Annex I to the Convention agreed by the Conference of the Parties at its nineteenth session (decision 24/CP.19), and set out in document FCCC/CP/2013/10/Add.3¹, and the requirements of Article 26 of the Regulation (EU) No 2018/1999 of the European Parliament and of the Council of 11 December 2018 on the Governance of the Energy Union and Climate Action, providing elements of the Portuguese National Inventory Report (NIR) necessary for the preparation of the Community greenhouse gas inventory report.

This submission refers to the AR5 global warming potentials.

This submission includes the following parts:

- 1 – The National Inventory Report (the present report), which includes the description of methodologies, the underlying data, the parameters, and the emission factors used in the Portuguese inventory;
- 2 – CRF (Common Reporting Format) data tables for the period 1990-2021, which were compiled with the CRF Reporter software (version v6.0.10_AR5);
- 3 – SEF (Standard Electronic Tables) for the reporting of Kyoto units in the national registry in 31.12.2022 and transfers of units during 2022.

¹ <http://unfccc.int/resource/docs/2013/cop19/eng/10a03.pdf#page=2>



General Index

EXECUTIVE SUMMARY

1. Introduction
2. Trends in Portuguese GHG Emissions
3. Energy (CRF 1)
4. Industrial Processes and Product Use (CRF 2)
5. Agriculture (CRF 3)
6. Land-Use, Land-Use Change and Forestry (CRF 4)
7. Waste (CRF 5)
8. Other (CRF 6)
9. Indirect Carbon Dioxide and Nitrous Oxide Emissions
10. Recalculations and Improvements

LIST OF ACRONYMS

REFERENCES

ANNEXES

- ANNEX A – Energy Balance
- ANNEX B – Energy
- ANNEX C – Agriculture
- ANNEX D – Waste
- ANNEX E – Key Category Analysis
- ANNEX F – Uncertainty Assessment
- ANNEX G – Identification of Organic Soils in Portugal
- ANNEX H – Activity data for HWP
- ANNEX I – WG1 Paper on guidance related to the reporting of indirect emissions
- ANNEX J – Supplementary information required under the Kyoto Protocol



EXECUTIVE SUMMARY

Updated: March 2023

- Portuguese greenhouse gas emissions without land-use, land-use change and forestry (LULUCF) totals 56.5 Mt CO₂ equivalent (CO₂e) in 2021, representing a decrease, respectively, of 5.1 % and 34.8 % in relation to 1990 and 2005, and a reduction of 2.8 % as compared to 2020.
- When considering the LULUCF sector, emissions in 2021 totalled 50.5 Mt CO₂e, corresponding, respectively, to a 24.3 % and 44.0 % decrease in relation to 1990 and 2005, and a variation of -5.5 % from 2020 to 2021.
- The largest contributor to the Portuguese emissions is the Energy sector (65.6 % of total emissions in 2021), with the energy industries and the transport activities amounting, respectively, to 14.6 % and 28.2 % of total emissions. In 2005 the Energy sector represented 74% of the total emissions, with the energy industries and transport corresponding to 29 % and 12 % of total emissions.
- Energy industries is the sector that registered the biggest decrease (20.9 %) from 2020 to 2021. This is the result of the combined effect of the greater proportion of renewable energy in the energy produced in Portugal (approximately 66% in 2021), the greater use of imports, and the definitive end of the use of coal in electricity production in 2021.
- In 2021, GDP registered a positive variation of + 5.5% compared to 2020.

ES 1. Background information

As a Party to the United Nations Framework Convention on Climate Change (UNFCCC), Portugal is requested to provide each year an update of its inventory of emissions and removals of greenhouse gas (GHG) not controlled by the Montreal Protocol. As a member of the European Union, the country is also required to report emission inventories data under Article 26 of the Regulation (EU) No 2018/1999 of the European Parliament and of the Council of 11 December 2018 on the Governance of the Energy Union and Climate Action.

The GHG emission inventory is the official annual accounting of all anthropogenic (human-induced) emissions and removals of greenhouse gases in Portugal. The inventory measures Portugal's progress against obligations under the United Nations Framework Convention on Climate Change (Climate Change Convention) and the European Union agreements (Regulation (EU) 2018/842 of the European Parliament and of the Council of 30 May 2018 on binding annual greenhouse gas emission reductions by Member States from 2021 to 2030).

This report presents a description of the methods, assumptions and background data used in the preparation of the 2023 national inventory submission of GHG.

The period covered is 1990-2021.

The 2006 IPCC Guidelines (2006, IPCC) have been applied to a large extent.



The GHG covered refer to emissions and removals of the carbon dioxide (CO₂), methane (CH₄), nitrous oxide (N₂O), hydrofluorocarbons (HFCs), perfluorocarbons (PFCs), sulphur hexafluoride (SF₆) and nitrogen trifluoride (NF₃). The indirect GHG, carbon monoxide (CO), sulphur dioxide (SO₂), oxides of nitrogen (NO_x) and non-methane volatile organic compounds (NMVOCs) are also included.

The information is reported under the five large sectors: Energy; Industrial Processes and Product Use (IPPU); Agriculture; Land Use, Land-Use Change and Forestry (LULUCF); and Waste.

The inventory covers the whole Portuguese territory, i.e., mainland Portugal and the two Autonomous regions of Madeira and Azores Islands. Emission estimates from aviation and navigation that took place between all national areas are also included.

Changes in methodology, source coverage or scope of the data were reflected in the estimation of the emissions for all years in the period from 1990 to 2021, i.e., the inventory is internally consistent.

The Portuguese Environmental Agency (*APA - Agência Portuguesa do Ambiente*)/ Portuguese Ministry of Environment and Climate Action (*Ministério do Ambiente e da Ação Climática*), is the national entity responsible for the overall coordination and updating of the National Inventory of Emissions by Sources and Removals by Sinks of Air Pollutants (INERPA) and the coordination of the national system (SNIERPA) that was first established through Council of Ministers Resolution 68/2005, of 17 March.

The current legal and institutional national arrangement has been adopted in 2015 (Council of Ministers Resolution No 20/2015) in order to take into account the developments at international level relating to the UNFCCC and the Kyoto Protocol, and the monitoring and reporting requirements under the EU Regulations, as well as complementary internal adjustments.

ES.2 Summary of national emissions and removal related trends

In 2021, total Portuguese GHG emissions, including indirect CO₂, without land-use, land-use change and forestry (LULUCF) were estimated at about 56.5 Mt CO₂e, representing a decrease of 5.1 % compared to 1990 levels and 34.8 % compared to 2005 levels, and a decrease of 2.8 % compared to the previous year (2020).

When considering the LULUCF sector, the national level of emissions in 2021 totalled 50.5 Mt CO₂e., corresponding to a 24.3 % decrease in relation to 1990, a reduction of 44.0 % comparing to 2005, and a variation of -5.5 % from 2020 to 2021.

Throughout this report, emissions values are presented in CO₂e using IPCC AR5 GWP values.

The reference to “total emissions” along the report is meant to refer to “total emissions without LULUCF, including CO₂ indirect emissions”.

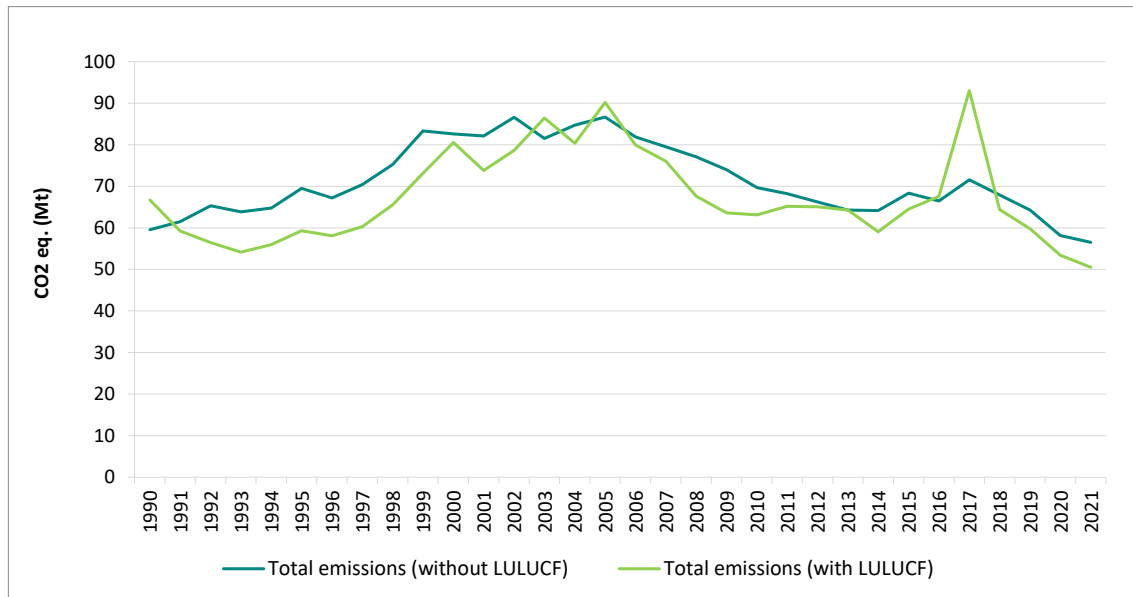

Figure ES.1: GHG emissions

National emissions developed rapidly during the 1990s, reflecting the evolution of the Portuguese economy, which was characterized by a strong growth associated with increased energy demand and mobility.

In the early 2000s, the growth of emissions has been more moderate and started to stagnate, registering thereafter, in particular after 2005, a decrease. This reduction is the result of the implementation of several measures such as the replacement of more polluting energy sources such as fuel oil with natural gas (introduced since 1997), the implementation of combined cycle power plants to NG (1999), the progressive installation of cogeneration units, the improvement of energy and technological efficiency of industrial processes, improvements in automobile efficiency (fleet renewal), and the improvement of fuels quality, among others.

These measures were accompanied by a continuous decline in energy consumption (both primary and final) verified in the country since 2005, with a significant expression in the period 2009-2013, fact that may be also explained by the internal economic recession, along with the European economic and financial crisis.

These years registered a slowdown of industrial activity and the cessation of some activities in the country such as black carbon production in 2013 and the production of ammonia in 2009 with the relocation of the production facilities.

In 2014 there was an inversion of this pattern. The evolution of the primary and, in particular, the final energy consumption trend increased, accompanying the positive evolution of the Portuguese economy.

The level of emissions shows, however, significant inter-annual variations, which are mostly occurring in the energy sector and are mainly related to the pronounced fluctuations of hydroelectric power generation that is highly affected by annual variations in precipitation.

The figure below illustrates the relative contribution of direct GHG to the total emissions for 1990 and 2021, showing CO₂ as the primary GHG, accounting for about 71 % of Portuguese emissions on a carbon equivalent basis in 2021 (LULUCF excluded). The second most important gas is CH₄, representing 18 % of total emissions in 2021.



Portugal has chosen 1995 as the base year for fluorinated gases. In 2021 these gases represented about 6 % of total GHG emissions. NF_3 emissions are non-occurring in Portugal.

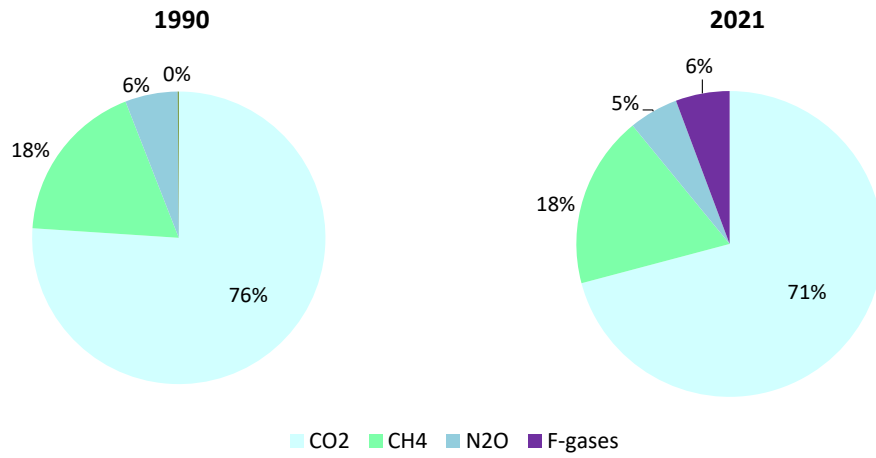

Figure ES.2: GHG emissions by gas

Over the 1990-2021 period, CO₂, CH₄ and N₂O registered a reduction. F-gases have significantly increased in importance, particularly in latest years (more than +4000 % since 1995).



Table ES.1: GHG emissions and removals in Portugal by gas

GHGs EMISSIONS	1990	1991	1992	1993	1994	1995	1996	1997	1998	1999	2000	2001	2002	2003	2004	2005
	CO ₂ equivalent (Gg)															
CO2 emissions without net CO2 from LULUCF	45,279	47,097	50,920	49,434	50,207	54,468	51,761	54,627	59,169	66,837	65,611	65,152	69,560	64,456	67,303	69,635
CO2 emissions with net CO2 from LULUCF	50,984	43,961	41,557	39,256	40,763	43,553	42,143	44,057	48,847	56,121	62,678	56,019	60,730	67,548	62,081	71,411
CH4 emissions without CH4 from LULUCF	10,736	10,873	10,928	10,994	11,138	11,313	11,521	11,736	11,961	12,228	12,453	12,450	12,473	12,479	12,473	12,396
CH4 emissions with CH4 from LULUCF	11,554	11,282	11,020	11,078	11,323	11,582	11,645	11,776	12,093	12,265	12,762	12,668	12,770	13,472	12,673	13,258
N2O emissions without N2O from LULUCF	3,458	3,428	3,395	3,318	3,308	3,456	3,636	3,683	3,712	3,805	3,978	3,855	3,752	3,620	3,885	3,443
N2O emissions with N2O from LULUCF	4,073	3,924	3,799	3,719	3,740	3,912	4,072	4,116	4,194	4,281	4,556	4,429	4,371	4,464	4,521	4,294
HFCs	NO,NA	NO,NA	NO,NA	NO,NA	NO,NA	54	79	138	200	281	360	462	589	720	829	985
PFCs	NO,NA	NO,NA	NO,NA	NO,NA	NO,NA	NO,NA	NO,NA	0	0	1	1	2	2	2	3	3
Unspecified mix of HFCs and PFCs	NO,NA	NO,NA	NO,NA	NO,NA	NO,NA	NO,NA	NO,NA	NO,NA	NO,NA	NO,NA	NO,NA	NO,NA	NO,NA	NO,NA	NO,NA	NO,NA
SF6	NO,NA	NO,NA	NO,NA	NO,NA	NO,NA	14	15	16	16	17	17	18	19	22	27	27
NF3	NO,NA	NO,NA	NO,NA	NO,NA	NO,NA	NO,NA	NO,NA	NO,NA	NO,NA	NO,NA	NO,NA	NO,NA	NO,NA	NO,NA	NO,NA	NO,NA
Total (without LULUCF)	59,473	61,397	65,243	63,745	64,653	69,306	67,013	70,199	75,059	83,169	82,420	81,940	86,395	81,299	84,521	86,489
Total (with LULUCF)	66,611	59,166	56,376	54,053	55,826	59,115	57,955	60,103	65,351	72,965	80,374	73,599	78,480	86,229	80,134	89,979
Total (without LULUCF, with indirect)	59,552	61,473	65,325	63,826	64,785	69,475	67,169	70,383	75,235	83,345	82,586	82,116	86,569	81,491	84,717	86,676
Total (with LULUCF, with indirect)	66,689	59,242	56,458	54,133	55,958	59,283	58,111	60,286	65,527	73,142	80,540	73,774	78,654	86,421	80,330	90,165

GHGs EMISSIONS	2006	2007	2008	2009	2010	2011	2012	2013	2014	2015	2016	2017	2018	2019	2020	2021	% change
	CO ₂ equivalent (Gg)																
CO2 emissions without net CO2 from LULUCF	64,843	62,355	60,028	57,136	52,934	51,740	49,899	48,103	47,885	52,203	50,367	55,106	51,373	47,494	41,695	39,938	-11.8
CO2 emissions with net CO2 from LULUCF	62,068	58,119	49,890	45,919	45,347	47,844	47,733	47,029	42,070	47,612	50,294	74,227	47,187	42,319	36,283	33,064	-35.1
CH4 emissions without CH4 from LULUCF	12,296	12,086	11,830	11,656	11,442	11,331	11,062	10,801	10,661	10,438	10,370	10,423	10,389	10,432	10,235	10,273	-4.3
CH4 emissions with CH4 from LULUCF	12,462	12,157	11,854	11,820	11,737	11,486	11,316	11,111	10,692	10,551	10,744	11,765	10,461	10,510	10,353	10,522	-8.9
N2O emissions without N2O from LULUCF	3,329	3,480	3,401	3,189	3,194	2,880	2,878	2,871	2,997	2,906	2,854	2,936	2,953	3,014	2,965	2,939	-15.0
N2O emissions with N2O from LULUCF	4,000	4,146	4,053	3,883	3,925	3,574	3,604	3,617	3,665	3,601	3,603	3,946	3,570	3,612	3,553	3,543	-13.0
HFCs	1,149	1,367	1,605	1,787	1,916	2,068	2,197	2,339	2,460	2,594	2,722	2,895	3,007	3,130	3,086	3,159	100.0
PFCs	4	5	6	7	8	9	10	11	13	14	15	17	19	21	24	27	100.0
Unspecified mix of HFCs and PFCs	NO,NA	NO,NA	NO,NA	NO,NA	NO,NA	NO,NE,NA	NO,NE,NA	NO,NE,NA	NO,NE,NA	NO,NE,NA	NO,NE,NA	NO,NE,NA	NO,NE,NA	NO,NE,NA	NO,NE,NA	NO,NE,NA	0.0
SF6	29	32	31	34	36	30	31	32	27	24	24	26	25	25	24	24	100.0
NF3	NO,NA	NO,NA	NO,NA	NO,NA	NO,NA	NO,NA	NO,NA	NO,NA	NO,NA	NO,NA	NO,NA	NO,NA	NO,NA	NO,NA	NO,NA	NO,NA	0.0
Total (without LULUCF)	81,649	79,325	76,901	73,810	69,530	68,058	66,077	64,157	64,042	68,179	66,352	71,404	67,765	64,116	58,029	56,359	-5.2
Total (with LULUCF)	79,712	75,826	67,439	63,449	62,969	65,012	64,892	64,139	58,926	64,396	67,403	92,876	64,268	59,617	53,322	50,338	-24.4
Total (without LULUCF, with indirect)	81,837	79,515	77,067	73,961	69,695	68,214	66,239	64,302	64,181	68,323	66,487	71,546	67,889	64,259	58,150	56,524	-5.1
Total (with LULUCF, with indirect)	79,899	76,016	67,605	63,600	63,134	65,167	65,054	64,284	59,065	64,540	67,537	93,018	64,392	59,761	53,443	50,503	-24.3

NA - Not applicable; NE - Not estimated; NO - Not occurring



ES.3 Overview of source and sink category's emission estimates and trends

According to the UNFCCC Reporting Guidelines, emissions estimates are grouped into five large IPCC categories: Energy, Industrial Processes and Product Uses (IPPU), Agriculture, LULUCF, and Waste.

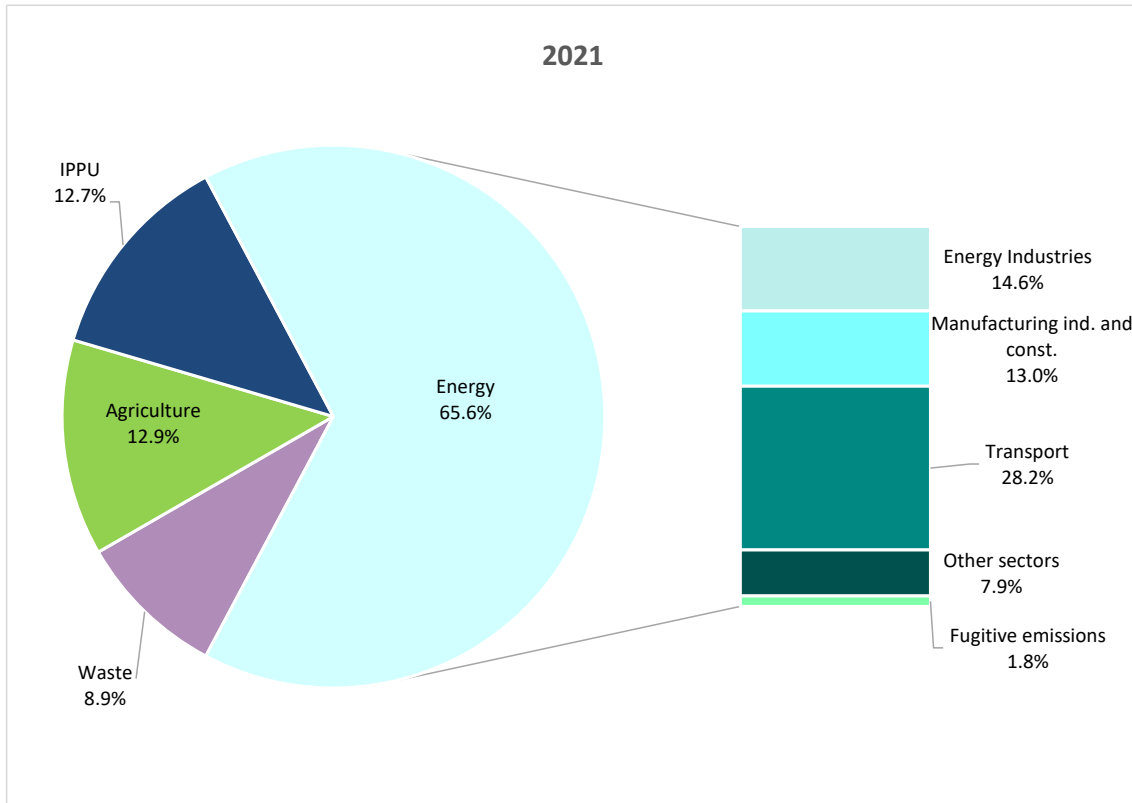

Figure ES.3: GHG emissions in Portugal by sector (LULUCF excluded)

Energy is by far the most important sector, accounting for approximately 66 % of total emissions in 2021 and registering a decrease of 9 % over the 1990-2021 period. Energy industries and transport are the two most important sources representing, respectively, around 15 % and 28 % of total emissions.

Within the energy industries, public electricity and heat production represented 11 % of the total emissions in 2021. This sector is reducing prominence since 2017 (66 % reduction from 2017 to 2021), due to both the effect of the greater importance of renewables in electricity generation and in particular to the shift from coal to natural gas in thermal energy production. The use of coal in electricity production ended definitively at the end of 2021.

Mobile sources, which are largely dominated by road traffic, are one of the sectors that have risen faster since 1990, due to the steady growth of vehicle fleets (in particular with more powerful engines) and road travel from 1990 to the early 2000s, reflecting the increase in family income and the strong investment in the road infrastructure of the country in the 1990s and 2000-10s decades. Indirectly, the increase in road traffic activity also augments emissions from fossil fuel storage, handling and distribution. As previously mentioned, the situation stabilized in the early 2000s and started to decline in 2005. An inversion of this tendency is, however, registered in most recent years, with an increase in transport emissions since 2013.



Still within the energy sector, the category “other sectors”, which include the residential and commercial activities, also registered a significant increase of emissions in the 1990-2004 period (74 %), but this tendency has decelerated (38 % decrease) since then, due to the implementation of energy efficiency measures.

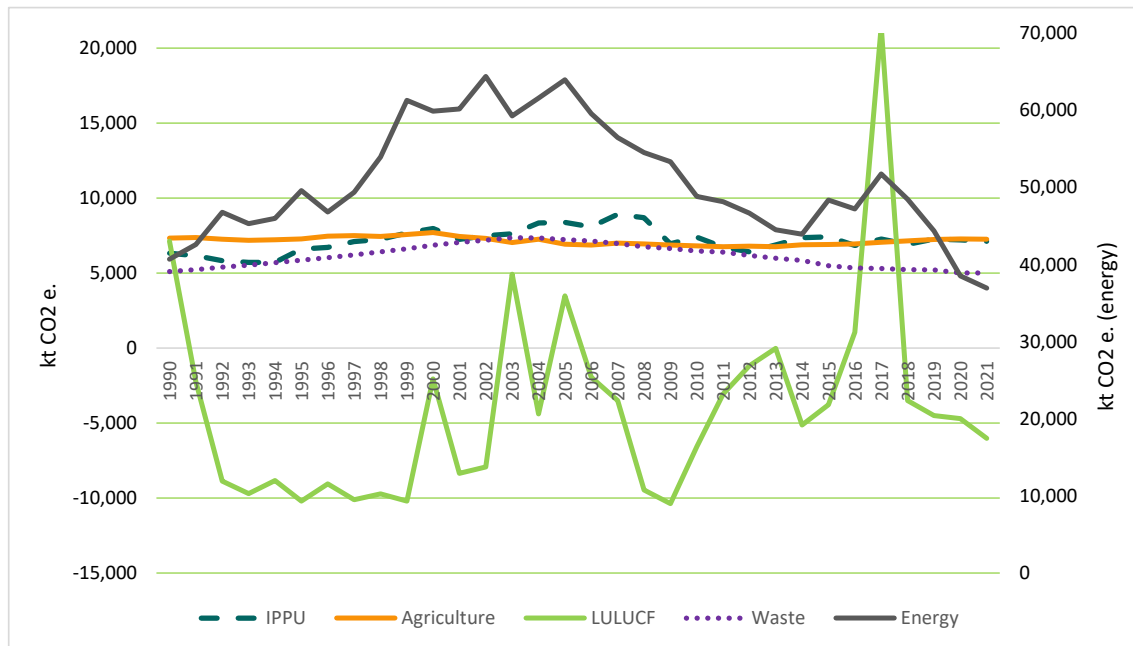

Figure ES.4: GHG emissions and removals by sector

Industrial processes represent about 13 % of the Portuguese emissions in 2021 and have grown also about 13 % since 1990. Emissions from this sector, which are generated as by-products of many non-energy-related activities, have been driven particularly until the mid-2000s by the evolution of the mineral and chemical industry. The increase of emissions in more recent years is related to a large extent to the increase of emissions of fluorinated gases, in particular with the subsectors of stationary air conditioning and commercial refrigeration.

Agriculture was, in the period analysed, a significant source of GHG emissions, responsible for 13 % of the Portuguese emissions in 2021, corresponding to a decrease of 1 % since 1990. This fact is related to the reduction in the livestock production of certain categories of animals (sheep and swine) and more recently of dairy cattle. Furthermore, the intensification of bovine (non-dairy cattle) production and the decreased consumption of fertilizers which relates in a certain extent to the conversion of arable crops to pasture also contributes to this trend. However, since the mid-2000s, in particular after 2011, this downward trend was reversed, registering since then a growing tendency (+ 7.2% emissions variation from 2011-2021), supported mainly by a significant increase in the population of non-dairy cattle, sheep and poultry.

Waste represented approximately 9 % of Portuguese emissions in 2021 and decreased 2 % since 1990. The sector recorded, however, an expressive increase of emissions until 2004 (approximately 44 %) and presents a general downward trend since then. This increase is primarily related to the rise of waste generation (associated with the development of household income and the growth of urbanization recorded in the country during the 1990s) and the deposition of waste predominantly in landfills.



The reduction in emissions in more recent years is associated to biogas recovery in waste and wastewater treatment systems, and the promotion of Mechanical and Biological Treatment, with the aim to divert urban waste from landfilling and the increase of recycling.

Estimates of emissions and sinks from land use change and forestry category show that this sector has changed from being a net emitter in 1990 (7.1 Mt CO₂ eq.) to a carbon sink in 1992. This situation was again reverted in the years 2003 and 2005 due to the severe forest wildfires events registered in these years. In 2017, this sector became a net emitter again, with a total of 21.5 Mt CO₂e., representing 23.2 % of the country's total emissions including the sector for that year. This situation was related to an exceptional and tragic year in terms of forest wildfires, associated to an exceptional dry year, high temperatures, occurring namely outside the normal summer period (biggest wildfires took place in June and October). Unusual strong winds also occurred, namely Ophelia hurricane, which swept the coast of the Iberian Peninsula in October 2017, a phenomenon that can be related to climate change. Since 2018, the sector is considered a sink (-3.4 Mt CO₂e., -4.4 Mt CO₂e., -4.6 Mt CO₂e. and 6.0 Mt CO₂e. in 2018, 2019, 2020 and 2021, respectively).

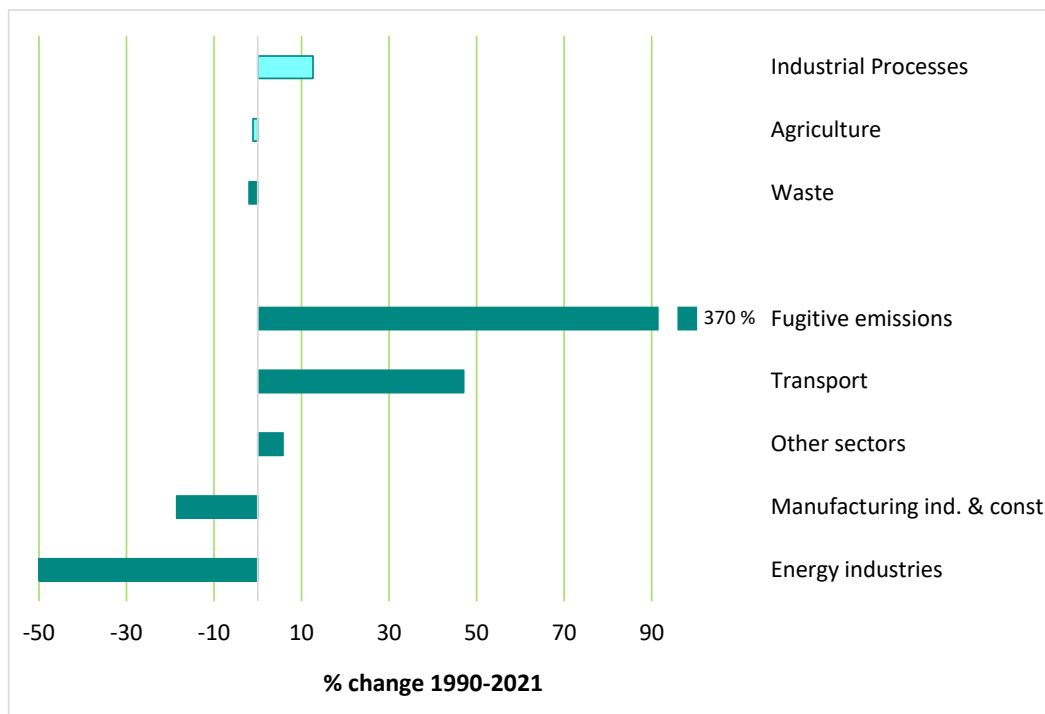

Figure ES.5: GHG emissions' percentage change (1990-2021) by IPCC category (LULUCF excluded)



Table ES.2: GHG emissions and removals by sector

GHGs SOURCE AND SINK CATEGORIES	1990	1991	1992	1993	1994	1995	1996	1997	1998	1999	2000	2001	2002	2003	2004	2005
	CO ₂ equivalent (Gg)															
1. Energy	40,692	42,622	46,775	45,308	46,004	49,571	46,806	49,378	53,932	61,278	59,880	60,191	64,370	59,264	61,575	63,955
2. Industrial processes and product use	6,332	6,166	5,819	5,709	5,723	6,602	6,712	7,109	7,249	7,683	7,972	7,253	7,501	7,625	8,341	8,378
3. Agriculture	7,339	7,369	7,253	7,196	7,222	7,278	7,467	7,494	7,454	7,584	7,699	7,449	7,326	7,048	7,254	6,929
4. Land use, land-use change and forestry(5)	7,138	-2,231	-8,867	-9,693	-8,826	-10,191	-9,058	-10,097	-9,708	-10,203	-2,046	-8,341	-7,915	4,930	-4,387	3,489
5. Waste	5,110	5,241	5,396	5,532	5,703	5,856	6,028	6,219	6,423	6,623	6,870	7,046	7,198	7,363	7,351	7,226
6. Other	NO	NO	NO	NO	NO	NO	NO	NO	NO	NO	NO	NO	NO	NO	NO	NO

GHGs SOURCE AND SINK CATEGORIES	2006	2007	2008	2009	2010	2011	2012	2013	2014	2015	2016	2017	2018	2019	2020	2021	% change
	CO ₂ equivalent (Gg)																
1. Energy	59,554	56,451	54,512	53,337	48,845	48,152	46,679	44,528	43,944	48,365	47,201	51,760	48,465	44,373	38,530	36,961	-9.2
2. Industrial processes and product use	8,083	8,913	8,695	6,959	7,392	6,732	6,423	6,885	7,362	7,412	6,849	7,273	6,914	7,271	7,213	7,132	12.6
3. Agriculture	6,879	6,995	6,944	6,881	6,814	6,769	6,794	6,757	6,890	6,911	6,954	7,068	7,149	7,249	7,272	7,258	-1.1
4. Land use, land-use change and forestry(5)	-1,937	-3,499	-9,462	-10,361	-6,561	-3,046	-1,185	-18	-5,116	-3,782	1,051	21,472	-3,497	-4,499	-4,707	-6,021	-184.4
5. Waste	7,134	6,967	6,749	6,634	6,478	6,405	6,181	5,986	5,846	5,490	5,348	5,304	5,237	5,222	5,015	5,008	-2.0
6. Other	NO	NO	NO	NO	NO	NO	NO	NO	NO	NO	NO	NO	NO	NO	NO	NO	NO

NA- Not applicable; NE - Not estimated; NO - Not occurring



ES.4 Other information

Several gases do not have a direct influence in climate change but affect the formation or destruction of other GHG. CO, NO_x, and NMVOC are precursor substances for ozone, which is a GHG. SO_x contributes to the formation of aerosols, which are extremely small particles or liquid droplets that can also affect the absorptive characteristics of the atmosphere.

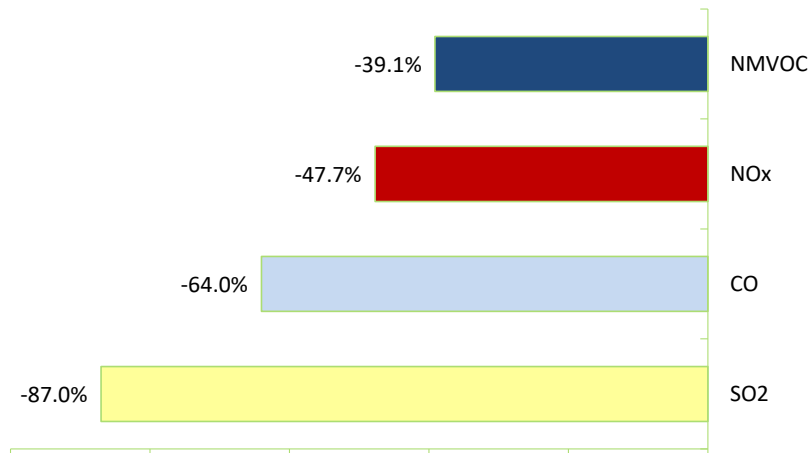

Figure ES.6: Indirect GHG and SO_x emissions: 1990-2021 variation

In 2021, emissions from all these gases have decreased compared to 1990 levels: SO_x - 87 %, CO - 64 %, NO_x - 48 %t and NMVOC - 39 %.

Energy sector is the most responsible for emissions of NO_x, SO_x and CO. Its contribution for NMVOC emissions is also significant, together with IPPU sector.

Within energy, transportation is responsible for the largest share of NO_x emissions, approx. 46 % of 2021 totals. Despite the fast growing trends of the transport sector (mainly road) since the 90s, the introduction of new petrol-engine passenger cars with catalysts converters and stricter regulations on diesel vehicles emissions, resulted in the limitation of the growth of these emissions or even in their decrease. In fact, the situation started to shift in the mid-2000s, as transport emissions growth has first stabilized and started to decline since 2005. In the most recent years, the situation has been inversed with an increase of emissions after 2013. In the reporting period, 1990-2021, NO_x emissions from transport decreased 42 %; and CO and NMVOC emissions registered reductions of more than 80 %. Other sectors (commercial/institutional, residential and agriculture/forestry) is a primary source of CO emissions representing approx. 37 % of the 2021 totals.

SO_x emissions are mainly generated in the energy industry sector (approximately 33 % of total emissions in 2021) and combustion in manufacturing industries (approximately 41 % of total emissions in 2021), which are major consumers of fossil fuels. In the past, oil and coal represented the biggest share of the fuel mix used in thermal electrical production in the country. The situation shifted along the years with the significant development of renewable sources and its greater importance in electrical production, and the introduction of new stricter laws regulating the residual fuel oil (Decree-Law No. 281/2000, 10th November). The introduction of natural gas and its increasing use since 1997 was a major step in the control of SO_x emissions. In 2021, natural gas represented the main fuel used in electric thermal generation.



The period 1990-2021 shows, in fact, a decrease in SO_x emissions in both sub-categories: energy industries (-93 %) and manufacturing industries (-79 %). Since 2007, SO_x emissions from energy industries registered a significant reduction (approximately 88 %), which is explained by the implementation of new abatement systems (desulfurization in two Large Point Source Energy Plants in Mainland Portugal).

The decline in emissions in electricity production in latest years is the result of the phase-down in the use of coal in thermal production, which was definitively phased-out at the end of 2021, with the closure of the last Portuguese coal thermal plant (Sines). The greater proportion of the renewable domestic production was also a major contributor to the emissions' reduction. Renewable sources grew 5 % in 2021 compared to 2020, mainly due to an increase of wind power (+7 %) and the use of biomass and solar energy in electricity production (respectively +6 % and + 30 %). The use of natural gas in energy production decreased by 9 % in 2021 compared to 2020.



Table ES.3: Indirect GHG and SOx emissions: 1990-2021

Gas emissions	1990	1991	1992	1993	1994	1995	1996	1997	1998	1999	2000	2001	2002	2003	2004	2005		
	CO ₂ equivalent (Gg)																	
CO	788	800	829	801	804	811	784	764	734	701	666	619	598	573	545	507		
NO _x	259	273	294	284	284	296	278	280	293	305	299	296	302	278	280	282		
NMVO _C	249	251	255	242	241	235	236	237	238	236	232	221	216	205	197	186		
SO ₂	318	308	367	310	288	322	263	275	322	331	295	277	277	185	188	189		

Gas emissions	2006	2007	2008	2009	2010	2011	2012	2013	2014	2015	2016	2017	2018	2019	2020	2021	% change
	CO ₂ equivalent (Gg)																1990-2021
CO	474	447	409	386	377	351	336	318	302	307	293	292	274	282	253	284	-64.0
NO _x	260	250	232	219	203	185	172	168	165	167	160	162	157	152	134	135	-47.7
NMVO _C	179	173	164	150	151	143	137	136	142	142	139	140	141	140	150	151	-39.1
SO ₂	165	157	104	72	62	57	52	48	43	45	45	46	45	44	38	41	-87.0

1 Introduction

Table of Contents

1	Introduction.....	1-1
1.1	Background information on greenhouse gas inventories and climate change.....	1-3
1.1.1	Global warming and climate change	1-3
1.1.2	Climate change in Portugal.....	1-3
1.1.3	The Convention, the Kyoto Protocol and national commitments.....	1-5
1.1.4	History of national inventories	1-6
1.1.5	Greenhouse gas emissions inventories	1-8
1.1.6	Global warming potentials	1-9
1.2	Institutional arrangements for inventory preparation.....	1-9
1.2.1	National Inventory System	1-9
1.2.2	Overview of inventory planning	1-13
1.3	Inventory Preparation Process	1-15
1.3.1	Responsibility.....	1-15
1.3.2	Calculation, data archiving and documentation system	1-15
1.4	General overview of methodologies and data sources used	1-16
1.5	Brief description of key source categories	1-20
1.6	Information on QA/QC	1-21
1.7	General uncertainty evaluation, including data on the overall uncertainty for the inventory totals 1-23	
1.8	Overview of the completeness.....	1-24
1.9	Reporting on consistency of the reported data on air pollutants (CO, SO ₂ , NO _x and NMVOC) ..	1-25
1.10	Comparison of the sectoral approach with the reference approach	1-26
1.11	Future developments	1-26



List of Figures

Figure 1.1: Mean air temperature anomalies, by decades, in Portugal Mainland.....	1-4
Figure 1.2: Precipitation anomalies, by decades, in Portugal Mainland	1-4
Figure 1.3: SNIERPA’s main elements relations.....	1-10
Figure 1.4: Main bodies of national system (SNIERPA)	1-12
Figure 1.5: Electronic System Structure of the estimation and reporting system	1-16
Figure 1.6: Trend of total GHG emissions with LULUCF and lower and upper estimates considering the 95 % confidence interval.....	1-24
Figure 1.7: Comparison between MMR and NECD estimates on air pollutants	1-25

List of Tables

Table 1.1: Global Warming Potentials (100-year time horizon).....	1-9
Table 1.2: Calendar for the inventory process	1-14
Table 1.3: Summary of methods and emission factors (CRF summary 3 table).....	1-17
Table 1.4: Main data sources used in the Portuguese inventory.....	1-19
Table 1.5: Overview of key categories (without LULUCF) using Approach 1 and 2 for 1990 and latest inventory year.....	1-20
Table 1.6: Overview of key categories (with LULUCF) using Approach 1 and 2 for 1990 and latest inventory year.....	1-21



1 Introduction

Updated: March 2023

1.1 Background information on greenhouse gas inventories and climate change

1.1.1 Global warming and climate change

Although key greenhouse gases - CO₂, CH₄, N₂O, Ozone – occur naturally in the atmosphere, human activities have increased their atmospheric concentrations since the pre-industrial era. Other substances which are exclusively produced by industrial activities are also greenhouse gases: stratospheric ozone depleting substances (CFCs, HCFCs and halons, which are covered by the Montreal Protocol), and some other fluorine-containing halogenated substances – hydrofluorocarbons (HFCs), perfluorocarbons (PFCs), sulphur hexafluoride (SF₆), and nitrogen trifluoride (NF₃) - do not deplete stratospheric ozone but are potent greenhouse gases. These latter substances are considered by the UNFCCC and accounted for in national greenhouse gas inventories.

There are also several gases that do not have a direct effect in global warming but affect the formation or destruction of other GHG. CO, NO_x, and NMVOCs are precursor substances for ozone which is a GHG. SO_x contributes to the formation of aerosols, which are extremely small particles or liquid droplets that can also affect the absorptive characteristics of the atmosphere.

Land-Use and Land-Use Change (LULUCF), particularly deforestation, is another factor that contributes to the phenomenon of global warming and climate change, as it changes carbon stocks and carbon sequestration and, consequently, the CO₂ fluxes from and to the atmosphere.

According to the IPCC, the average surface temperature of the earth has risen by about 0.6-0.7°C in the past 100 years and will rise by another 1.4-5.8°C in the next 100 years, depending on the GHG's emissions scenario.

An increase in global temperatures can result in a cascade of environmental effects, including the rise of sea level and changes in the amount and pattern of precipitation. These changes may increase the frequency and intensity of extreme weather events, such as floods, droughts, heat waves, hurricanes, and tornados. Other consequences include higher or lower agricultural yields, glacial retreat, reduced summer stream flows, extinction of species and increases in the ranges of disease vectors.

1.1.2 Climate change in Portugal

The mean temperature has risen in all regions of Portugal since the 1970s, at a rate of approximately 0.3 °C per decade. The time-series analysis of the mean annual temperature since 1931 shows that 1997 was the warmest year, and the five warmest years occurred after the 1990s. The year of 2017 is the second warmest of the last 88 years and is among the four driest since 1931, with the average annual total precipitation around 60 % of the normal levels.

In Portugal Mainland, the decade of 1991/2000 was the warmest (next figure).

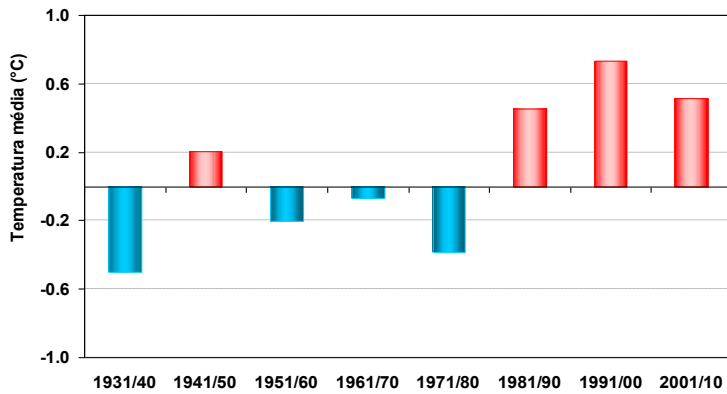

Source: IPMA, 2013

Figure 1.1: Mean air temperature anomalies, by decades, in Portugal Mainland

Also an observation of temperature indexes indicates that the increase of the mean temperature was accompanied by a change in the frequency of very hot days and a decrease in the frequency of very cold ones.

The heat wave duration index has also been rising. Heat waves are defined when, in a period of at least 6 consecutive days, the daily maximum temperature is 5 °C higher than the daily mean value of the reference period (1961-1990). Although they can occur at any time of the year, heat waves have a more significant impact in the summer months. Heat waves were more frequent in the 1990s. The heat waves of 1981, 1991, 2003 and 2006 were of particular significance due to their duration and spatial extension.

The last 2 decades of the 20th century were particularly dry in mainland Portugal, as opposed to the average values registered between 1961 and 1990. In fact, only in 6 of the last 20 years of the past century the annual precipitation was higher than the average. In 2001 and 2002, however, the annual precipitation values were higher than the average observed in the reference period. The driest of the past 75 years was 2005, and 2004 was the second driest on record. The first decade of the 21st century (2001/2010) was the driest since 1932 (next figure).

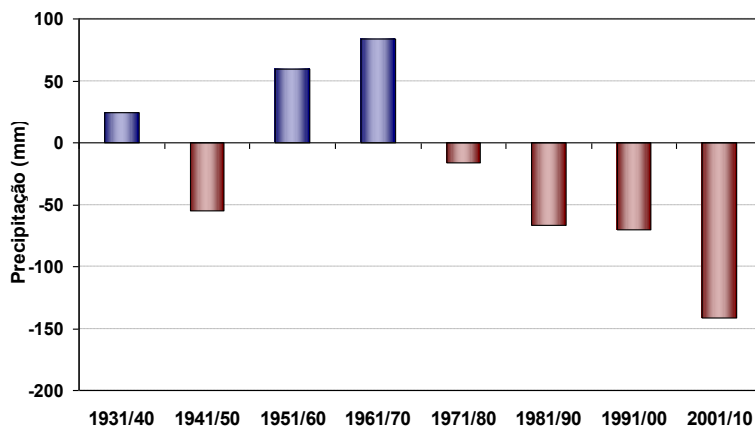

Source: IPMA, 2013

Figure 1.2: Precipitation anomalies, by decades, in Portugal Mainland

The seasonal trend in the mean precipitation values recorded since 1931 shows a systematic and statistically significant reduction in precipitation in the spring over the last three decades of the 20th century, with slight increases during the other seasons. In 2000 and 2001, spring precipitation rose to values not observed since the late 1960s.



Annual variability of winter precipitation increased over the last 30 years, with the occurrence of both drier and rainier winters. The winter of 2000/2001 was particularly rainy (the third most rainy of the last 30 years), and winter of 2001/2002 was the fifth driest of the last 3 decades. The winter of 2004/2005 was the driest winter observed in the last 75 years. The autumn of 2006 was the third most rainy since 1931.

All models from the different scenarios forecast a significant increase in the mean temperature for all regions of Portugal until the end of the 21st century. In the mainland, summer maximum temperature increases are estimated to vary between 3 °C and 7 °C in coastal and interior areas, respectively, accompanied by a strong increment in the frequency and intensity of heat waves.

With regards to precipitation, future climatic uncertainty is considerably stronger. Nevertheless, most models project a reduction in total precipitation in all regions, with more intense periods of rain in shorter time frames in the winter.

1.1.3 The Convention, the Kyoto Protocol and national commitments

The United Nations Framework Convention on Climate Change (UNFCCC) was created as an answer of the international community to the emerging evidences of climate change and was adopted and opened for signature in Rio de Janeiro in 1992.

The ultimate objective of the Convention is the “stabilization of greenhouse gas concentrations in the atmosphere at a level that would prevent dangerous anthropogenic interference with the climate system.” Portugal ratified the UNFCCC on May 31st, 1994.

The Kyoto Protocol (KP), adopted some years later in 1997, represents a deepening in the commitments inscribed in the Convention. The Protocol introduced legally binding commitments for developed countries to reduce their collective emissions of greenhouse gases by at least 5 % by the period 2008-2012 (first commitment period of the Protocol), below their 1990 level.

Portugal signed and ratified the KP on the April 29th, 1998, and May 31st, 2002, respectively. The EU as a whole agreed to an 8 % reduction. Under the EU burden-sharing agreement Portugal is committed to limiting its emissions during the first commitment period to no more than +27 % compared to the 1990 level.

The KP entered into force on February 16th, 2005, after Russia’s ratification in November 2004 which fulfilled the requirement that at least 55 Parties to the Convention, including developed countries accounting for at least 55 % of that group’s CO₂ emissions in 1990.

Detailed rules for the implementation of the Protocol were set out at the 7th Conference of the Parties (in Marrakech) and are described in the Marrakech Accords adopted in 2001. At the first Conference of the Parties serving as the Meeting of the Parties to the Protocol (COP/MOP) held in Canada (December 2005) the rules for the implementation of the Protocol agreed at COP7 were adopted.

In Doha, Qatar, on 8 December 2012, the Doha Amendment to the Kyoto Protocol was adopted. This launched a second commitment period, starting on 1 January 2013 until 2020, with a revised list of GHG to be reported and necessary updates for several articles of the Kyoto Protocol.

For the second commitment period, Parties committed to reduce GHG emissions by at least 18 % below 1990 levels in the eight-year period from 2013 to 2020. The EU and its Member States have committed to this second phase of the Kyoto Protocol and established to reduce their collective emissions to 20 % below their levels in 1990 or other chosen base years. The target will be fulfilled jointly with Iceland.

The 2015 Paris Agreement, adopted in Paris on 12 December 2015, marks the latest step in the evolution of the UN climate change regime and builds on the work undertaken under the Convention. The Paris Agreement charts a new course in the global effort to combat climate change for the period after 2020.



The Paris Agreement's central aim is to strengthen the global response to the threat of climate change by holding the increase in the global average temperature to well below 2 °C above pre-industrial levels and pursuing efforts to limit the temperature increase to 1.5 °C above pre-industrial levels, recognizing that this would significantly reduce the risks and impacts of climate change. It also sets the goal of increasing the ability to adapt to the adverse impacts of climate change and foster climate resilience and low greenhouse gas emissions development, in a manner that does not threaten food production. Finally, it also sets the goal of making finance flows consistent with a pathway towards low greenhouse gas emissions and climate-resilient development.

The Paris Agreement entered into force on 4 November 2016, thirty days after the date on which at least 55 Parties to the Convention accounting in total for at least an estimated 55 % of the total global greenhouse gas emissions have deposited their instruments of ratification.

In 2016, following the ratification of the Paris Agreement, Portugal established the national objective to achieve carbon neutrality by 2050. The work under the 2050 Carbon Neutrality Roadmap outlined a trajectory of -45 % to -55 % GHG emissions' reduction by 2030, -55 % to -65 % by 2040 and -85 % to -90 % by 2050.

1.1.4 History of national inventories

Air emission inventories in Portugal were only initiated in the late 80s, early 90s when the first estimates of NO_x, SO_x and VOC emissions from combustion were made under the development of the National Energetic Plan (PEN - Plano Energético Nacional), and emissions from combustion and industrial processes were made under OECD inventory and under CORINAIR85 programme. A major breakthrough occurred during the CORINAIR90 inventory done during 1992 and 1993 by the General-Directorate of Environment (DGA, presently the Portuguese Environment Agency -APA). This inventory exercise, aiming also to respond to EMEP and OECD/IPCC, extended the range of the pollutants (SO_x, NO_x, NMVOC, CH₄, CO, CO₂, N₂O and NH₃) and emission sources covered, including not only combustion activities but also storage and distribution of fossil fuels, production processes, use of solvents, agriculture, urban and industrial wastes and nature (forest fires and NMVOC from forest). Information received under the Large Combustion Plant (LCP) directive was also much helpful to improve inventory quality and the individualization of Large Point Sources, as well as statistical information received from the National Statistical Institute (INE) allowing the full coverage of activity data for most emission sources. The CORINAIR90 Default Emission Factors Handbook (second edition), updating the first edition from CORINAIR85 was used extensively in the development of the current inventory and it was also a key point in the amelioration of the inventory.

The fulfilment of international commitments under the UNFCCC and CLRTAP conventions, together with the publication of the IPCC Draft Guidelines for National Greenhouse Gas Inventories (IPCC, 1995) and latter of the Revised 1996 IPCC Guidelines for National Greenhouse Gas Inventories (IPCC, 1997), resulted in substantial improvement of the methodologies that are used in the inventory, particularly for agriculture and waste, and that were included by the first time in the First National Communication in 1994.

The inventory that resulted from CORINAIR90 (CEC, 1992) and subsequent modifications from IPCC methodology still structures the present day methodology in what concerns activity data and methodology. Under the evaluation of the first communication the inventory was subject to a review made by an international team. All national communications up until the present day (last was the 7th National Communication, submitted in 2017) were also reviewed by international experts. These exercises had an important role in problem detection and contribute to overall improvement.

Since its first compilation, the Portuguese inventory has been continuously amended mainly due to the use of more detailed methodologies, better access to underlying data allowing the development of the comprehensiveness of the inventory, and better database storage and calculation structure.



Changes in methodology, source coverage or scope of the data were reflected in the estimation of the emissions for the different years considered, i.e., the inventory is internally consistent.

Some major studies have contributed to the improvement of the inventory:

- Study of VOC emissions in Portugal, in 1995. This study made in collaboration with FCT (Faculdade de Ciências e Tecnologia) led to an important improvement in emission estimates from solvent sector, which is still used as basic information source for this sector;
- Study of Emission and Control of GHG in Portugal (Seixas et al, 2000). This project aimed the first development of projections toward 2010 and the identification of control measures to accomplish the Kyoto Protocol. This also led to improvements in the inventory: extension of the inventory including for the first time also carbon dioxide sinks (forest); a first attempt to estimate solid waste methane emissions from urban solid wastes using a Tier 2 approach and, in general terms, a better insight into additional parameters used in the inventory methodologies, and that has resulted from interaction with several institutional agents: General Directorate of Energy, Ministry of Agriculture; and the inter-ministerial transport group;
- Study for the quantification of carbon sinks in Portugal (Pereira *et al.*, 2002), made under the development of PNAC and PTEN national programmes;
- Revision of the Energy Balances with comparison of information collected at APA (LCP Directive) and Statistical Information received at DGEG: Energy Balances. The 1990s – DGE (2003);
- PNAC 2004 (National Plan for Climate Change) approved by Ministers Council and published recently in the National Official Journal (OJ nº 179, 31 July 2004, I Série B/ Resolução do Conselho de Ministros nº 119/2004);
- PNAC 2006 (National Plan for Climate Change) approved by Ministers Council and published in the National Official Journal (OJ nº 162, 23 August 2006, I Série B/ Resolução do Conselho de Ministros nº 104/2006);
- Sectoral Studies and Proposal for a PTEN (National Plan on Emission Ceilings);
- PNALE (National Plan for Allocation of Emissions) 2005-2007 or Portuguese PNALE I, adopted by Ministers Council (Resolução do Conselho de Ministros n.º 53/2005) and published in the National Official Journal (OJ No.44, 3 March 2005, I Série B);
- Bilateral meetings (APA/UE) for the determination of the Baseline Scenario under the CAFE program (APA, 2004);
- Methodological Development Plan (PDM) under the implementation of the National Inventory System;
- UNFCCC reviews, in particular the in-depth review (September/October 2004), and the centralised reviews (October 2005 and September 2008);
- UNFCCC in-depth review of the Initial Report in May 2007 which fixed the Assigned Amount for the first commitment period;
- 2012 technical review of the greenhouse gas emission inventory of Portugal to support the determination of annual emission allocations under Decision No.406/2009/EC;



- UNFCCC in-depth review of the 2012 greenhouse gas emission inventory in September 2012;
- UNFCCC centralised review of the 2013 and 2014 greenhouse gas emission inventory in September 2013 and 2014;
- 2016 EU comprehensive review of national greenhouse gas inventory data pursuant to Article 19(1) of Regulation (EU) No.525/2013;
- UNFCCC centralised review of the 2015 and 2016 greenhouse gas emission inventory in September 2016;
- 2017 and 2018 Comprehensive Technical Reviews of National Emission Inventories pursuant to the Directive on the Reduction of National Emissions of Certain Atmospheric Pollutants (Directive (EU) 2016/2284);
- UNFCCC in-depth review of the 2018 greenhouse gas emission inventory in September 2018;
- 2020 Comprehensive Review of National Greenhouse Gas Inventory Data pursuant to Article 4(3) of Regulation (EU) No.2018/842 and to Article 3 of Decision No.406/2009/EC;
- UNFCCC centralised review of the 2020 greenhouse gas emission inventory in October 2020;
- 2021 annual review of national greenhouse gas inventory data pursuant to Article 19(2) of Regulation (EU) No.525/2013;
- UNFCCC centralised review of the 2022 greenhouse gas emission inventory in October 2022.

1.1.5 Greenhouse gas emissions inventories

Parties to the Convention (Article 4(1)(a)) “shall develop, periodically update, publish and make available to the COP (...), national inventories of anthropogenic emissions by sources and removals by sinks of all greenhouse gases not controlled by the Montreal Protocol, using comparable methodologies”.

Portugal, as a Party to the Convention, is required to produce and regularly update National Greenhouse Gas Inventories. Furthermore, Parties shall submit a National Inventory Report (NIR) containing detailed and complete information on their inventories, in order to ensure the transparency of the inventory.

The inventory covers the 6 gaseous air pollutants included in Annex A to the Kyoto Protocol: carbon dioxide (CO₂), methane (CH₄), nitrous oxide (N₂O), hydrofluorocarbons (HFC), perfluorocarbons (PFCs), sulphur hexafluoride (SF₆), and nitrogen trifluoride (NF₃), as well as estimates for indirect GHGs, including carbon monoxide (CO), nitrogen oxides (NO_x), and non-methane volatile organic compounds (NMVOC). Data are also reported for sulphur oxides (SO_x). Emissions are estimated for each civil year since 1990.

As a general rule, the inventory covers emissions occurring in the whole Portuguese territory, i.e., mainland Portugal and the two autonomous regions of Madeira and Azores Islands. Emissions from aviation and navigation occurred within national territory, including movements between the Mainland and the Islands, are also included in national emissions’ total.

The economic sectors covered are the following: energy production and transformation, combustion in industry, domestic, agriculture, fisheries, institutional and commerce sectors, transportation (road, rail, maritime and air), industrial production and use of solvents, waste production, disposition and treatment (urban, industrial and hospitals solid wastes, and domestic and industrial waste water), agriculture, animal husbandry emissions, as well as emissions and removals from forestry and land use change.



1.1.6 Global warming potentials

A Global Warming Potential (GWP) is defined as the cumulative radiative forcing over a specified time horizon resulting from the emission of a unit mass of gas relative to some reference gas (IPCC, 1997).

The reference gas used is CO₂. The mass emission of each gas multiplied by its GWP gives the equivalent emission of the gas as carbon dioxide equivalents (CO₂ e). The Parties to the UNFCCC have agreed to use GWPs based on a 100-year time horizon.

The present GWP considered are the values proposed by the *IPCC Fifth Assessment Report (AR5)* (IPCC 2014) as required by the revised UNFCCC reporting guidelines.

Table 1.1: Global Warming Potentials (100-year time horizon)¹

GHG	SAR	AR4	AR5
CO2	1	1	1
CH4	21	25	28
N2O	310	298	265
HFC-23	11 700	14 800	12 400
HFC-32	650	675	677
HFC-43-10mee	1 300	1 640	1 650
HFC-125	2 800	3 500	3170
HFC-134a	1 300	1 430	1 300
HFC-152a	140	124	138
HFC-143a	3 800	4 470	4 800
HFC-227ea	2 900	3 220	3 350
HFC-236fa	6 300	9 810	8 060
CF4	6 500	7 390	6 630
C2F6	9 200	12 200	11 100
C3F8	7 000	8 830	8 900
C4F10	7 000	8 860	9 200
C6F14	7 400	9 300	7 910
SF6	23 900	22 800	23 500
NF3	NA	17 200	16 100

Source: IPCC Fourth Assessment Report (AR4) (IPCC 2007); IPCC Fifth Assessment Report (AR5) (IPCC 2014)

1.2 Institutional arrangements for inventory preparation

1.2.1 National Inventory System

No major changes occurred in the national inventory system and the institutional arrangements since the 2022 submission.

The current legal national arrangement for a National Inventory System was adopted in 2015 (Council of Ministers Resolution No.20/2015). It builds on the previous version (Council of Ministers Resolution No.68/2005), which has been revised and reorganized to take into account the developments at international level relating to the UNFCCC and the Kyoto Protocol, and the monitoring and reporting requirements provided at the EU level by Regulation (EU) 525/2013 of the European Parliament and of the Council of 21 May 2013, on a mechanism for monitoring and reporting greenhouse gas emissions and for reporting other information at national and Union level relevant to climate change, that has been repealed by Regulation (EU) No 2018/1999 of the European Parliament and of the Council of 11 December 2018 on the Governance of the Energy Union and Climate Action, and the requirements under the CLRTAP and the NECD.

¹ https://www.ghgprotocol.org/sites/default/files/ghgp/Global-Warming-Potential-Values%20%28Feb%2016%202016%29_1.pdf



The 2015 Council of Ministers Resolution, restructures and elaborates the previous legal framework on the National System (SNIERPA), specifying its 4 different components:

- i) a calculation and archiving system of the national inventory;
- ii) the QA\QC System;
- iii) the Methodological development Plan (PDM);
- iv) the Archiving System.

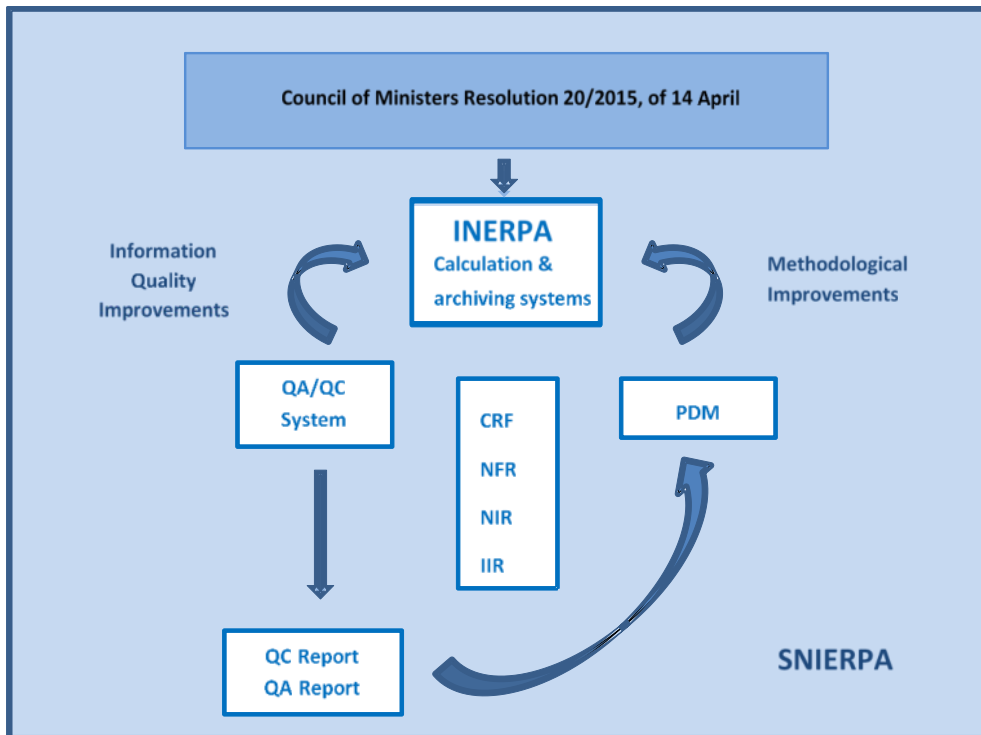

Figure 1.3: SNIERPA's main elements relations

Furthermore, it identifies the several outputs and formats of reporting to the international bodies, and specifies the functions of the entities making part of SNIERPA:

- i) the coordinating entity;
- ii) the Sectoral Focal Points;
- iii) the entities involved.

The APA, is the Responsible Body that assures the overall coordination and updating of the National Emissions Inventory (INERPA); the inventory's approval, after consulting the Focal Points and the involved entities; and its submission to EC and international bodies to which Portugal is associated, in the several communication and information formats, thus ensuring compliance with the adopted requirements and directives.

APA's Climate Change Department (DCLIMA) is the unit responsible for the general administration of the inventory and for all aspects related to its compilation, reporting and quality management.

During 2020, DCLIMA was restructured (Deliberação n.º 498/2020, 21 de abril de 2020, Diário da República, 2ª Série, Parte C, No. 78). Previous Adaptation Division and Monitoring (DAM) responsible for the National Inventory was extinguished and replaced by the International Inventory and Strategy Division (DIEI), which is now responsible for the coordination of the National Inventory System (SNIERPA) and the annual compilation of the inventories. The reorganisation of DCLIMA did not change however the previous competences and arrangements regarding the inventory.



Data from different sources is collected and processed by the inventory team, who is also responsible for the application of QA/QC procedures, the assessment of uncertainty and key category analysis, the compilation of the CRF tables and the preparation of the NIR, the response to the review processes and data archiving and documentation.

The Sectoral Focal Points work with APA/DCLIMA in the preparation of INERPA, and are responsible for fostering intra and inter-sectoral cooperation to ensure a more efficient use of resources. Their main task includes coordinating the work and participation of the relevant sectoral entities over which it has jurisdiction. It is also the Focal Points duty to provide expert advice on methodological choice, emission factor determination and accuracy of the activity data used. Focal Points play a vital role in sectoral quality assurance and methodological development. They are also responsible for the production of statistical information and data publication that are used in the inventory estimates.

The involved entities are public or private bodies which generate or hold information which is relevant to the INERPA, and which actions are subordinate to the Focal Points or directly to the Responsible Body.

All governmental entities have the responsibility to ensure, at a minimum, co-funding of the investment needed to ensure the accuracy, completeness and reliability of the emissions inventory.

Following the publication of the Council of Ministers Resolution No. 20/2015 of 14 April, which restructured the SNIERPA, a set of implementing procedures were agreed within SNIERPA to facilitate the good functioning of the national system, defining in more detail some competences, such as the regularity of the meetings and the deadlines for the information´ transmission, among other issues.

The following figure presents the main entities that are part of the national system.

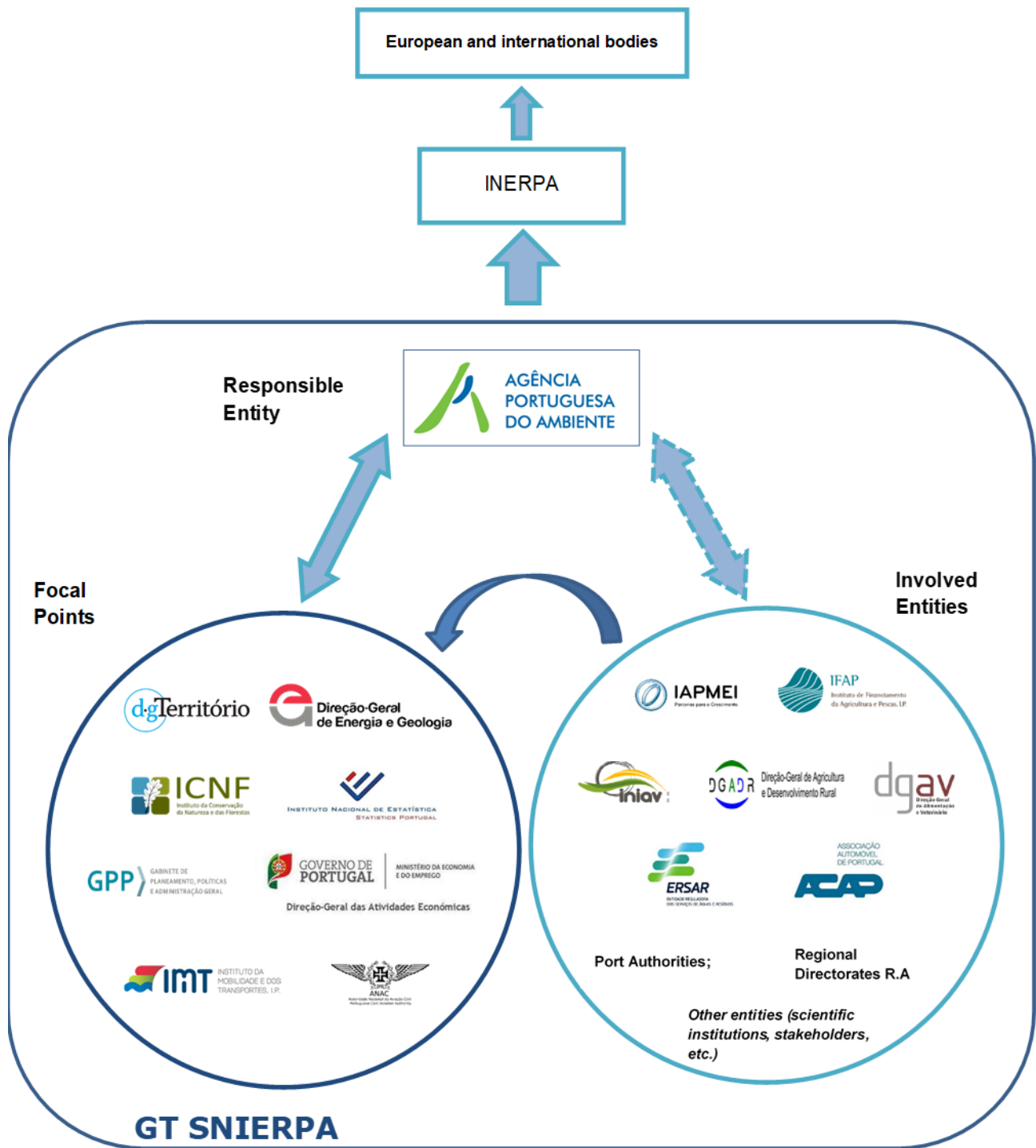

Figure 1.4: Main bodies of national system (SNIERPA)



1.2.2 Overview of inventory planning

All the participating organizations represented in SNIERPA support the annual production of the national inventories and the fulfilment of the reporting requirements.

Future planned improvements are compiled annually for each sector by the relevant inventory experts and the inventory coordinator, having as a basis the issues raised and the recommendations from the annual review processes and the problems identified from the application of QA/QC procedures, as well as future new reporting obligations. All identified items are gathered in a Methodological Development Plan (PDM – Plano de Desenvolvimento Metodológico) which is updated every year. A priority level is attributed to each issue identified, considering their importance in terms of the contribution to total GHG emissions, the level of uncertainty associated and the economic and technical resources available.

Each year, typically in June according to the agreed calendar of INERPA, APA, as coordinator of SNIERPA, organizes a kick-off meeting to plan and launch, in coordination with the sectoral focal points and the involved entities, the work for the following inventory submission(s). Bilateral meetings occur as necessary as consequence of this meeting aiming at discussing the specific issues related to each sector and to agree on the actions to be implemented in the framework of SNIERPA during this inventory compilation regarding the next submission.

The following table presents the overall calendar of the INERPA's elaboration process, which includes four main phases: planning, compilation, QA/QC verification and improvement (PDM activities).



Table 1.2: Calendar for the inventory process

Date	Task	Process	Tasks
May - June	- Elaboration of QA/QC plan - Definition/update of inventory development priorities (PDM)	Inventory Planning	- setting of quality objectives - identification of priorities taking into account the latest reviews and QA/QC checks
June	Kick-off meeting of SNIERPA WG for the launch of the annual inventory work	Inventory Planning	- discussion of the QA/QC plan - discussion and of the inventory development priorities (PDM)
June - December	- end September: deadline for routine data collection/ delivery by FP and/or IE to the APA - end October: deadline for the implementation of Methodological Development Plan (PDM) improvements	Inventory Compilation/ Improvement/ Verification	- approval of the QA/QC plan and of the PDM - collection of activity data and EFs update - implementation of methodological improvements - estimation of emissions/ removals - application of QA/QC checks - uncertainty and KC assessment - archiving of information - preparation of submissions by the inventory team
15 January	<i>Preliminary CRF and Short NIR submission to EC (DG CLIMA) [Monitoring Mech. of GHG under EU]</i>	<i>Reporting</i>	-
	Preparation of NFR submission	Inventory Verification/ Improvement	- application of QA/QC checks - implementation of corrections and late data updates
14 February	<i>Official consideration/approval of the NFR submission to UNECE [CLRTAP]</i>	<i>Approval</i>	<i>Approval by President of APA</i>
15 February	<i>Official NFR submission to NECD [EU] and UNECE [CLRTAP]</i>	<i>Reporting</i>	-
	- Revision of CRF submission - Preparation of NIR and IIR - Circulation of NIR and IIR comments among FP and/or IE	Inventory Verification/ Improvement	- application of QA/QC checks - implementation of corrections and late data updates
9 March	- Deadline for NIR and IIR comments from FP and/or IE	Inventory Verification	-
14 March	<i>Official consideration/approval of the CRF and NIR submission to EC (DG CLIMA) [Monitoring Mech. of GHG under EU]</i>	<i>Approval</i>	<i>Approval by President of APA</i>
15 March	<i>Submission of CRF and NIR (final versions) to the EC (DG CLIMA) [Monitoring Mech. of GHG under EU]</i>	<i>Reporting</i>	-
15 March	<i>Submission of IIR to NECD [EU] and UNECE [CLRTAP]</i>	<i>Reporting</i>	-
	- Implementation of QA/QC checks	Inventory Verification	- application of QA/QC checks including the NIR
15 April	<i>Submission of CRF and NIR (final version) to the UNFCCC [UNFCCC and Kyoto Protocol]</i>	<i>Reporting</i>	-
8/27 May	<i>Resubmission (if needed) of CRF and NIR (final version) to the EC and UNFCCC [UNFCCC and Kyoto Protocol]</i>	<i>Reporting</i>	-



1.3 Inventory Preparation Process

1.3.1 Responsibility

As referred in section 1.2.1, APA/DCLIMA is the national entity responsible for the overall coordination of the Portuguese inventory of air pollutants emissions. According to these attributions, APA makes an annual compilation of the Portuguese Inventory of air emissions which includes GHG's sources and sinks, acidifying substances as well as other pollutants. The reporting obligations to the EU and the international instances are also under the responsibility of APA.

The designated representative is:

Agência Portuguesa do Ambiente

Departamento de Alterações Climáticas (DCLIMA)

Address: Rua da Murgueira, 9/9A, 2610-124 Amadora, Portugal

Telephone: +351 21 472 82 93

Fax: + 351 21 471 90 74

Contact: Ana Paula Rodrigues – apaula.rodrigues@apambiente.pt (Head of Department)

1.3.2 Calculation, data archiving and documentation system

The emissions' calculations have been performed by APA/DCLIMA. However, many other institutions and agencies contributed to the inventory process, providing activity data, sectoral expert judgment, technical support and comments. All calculation and reporting rely in a set of different Excel spreadsheet workbooks which had been developed in order that all information and calculations occur automatically. The structure of the information system is outlined in figure below.

The information received from the several data suppliers is stored in its original format (paper or digital). A copy of this information is converted into the working workbooks, where data is further processed, linkage made and calculations performed, maintaining hence the integrity of the original data sources.

The IT system has been developed to answer to the various international obligations and national needs. At present, the different demands refer to: UNFCCC (CRF format); UNECE/CLRTAP (NFR format); LCP Directive (NFR format); as well as national needs such as the State of Environment Reports. There is independency between emission calculations and the required structure necessary for each obligation which allows flexibility in the inventory.

In what refers to the maintenance of the annual inventory documentation, the information is archived in a way that enables each inventory estimate to be fully documented and reproduced if necessary. When major changes are done in methodology and emission factors, and particularly after a reporting cycle, the older spreadsheets are frozen and work restarts with copies of those spreadsheets, making a clear reference to the period when they were used. Minor corrections, which do not affect the estimations, are not stored due to storage area limitations.

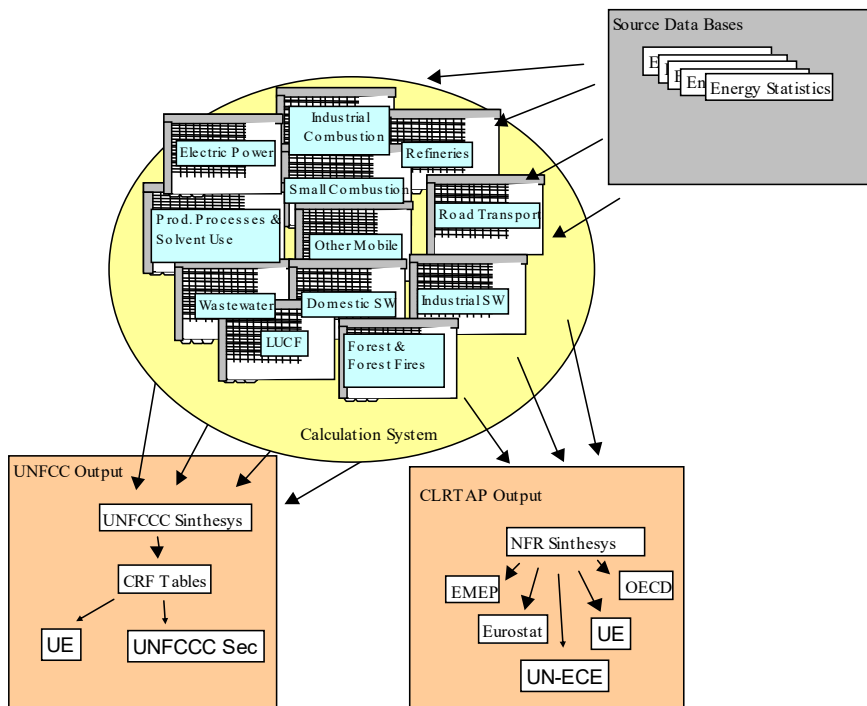

Figure 1.5: Electronic System Structure of the estimation and reporting system

All the inventory material, calculation files and reported tables, as well as the underlying data, the scientific documentation and studies used are stored and archived electronically, on a data server located at the APA premises where the inventory team key is located. All data are backed up daily. Hence, the present system existing in APA is considered to ensure the basic requirements/functions of an IT system: centralized data processing and storage.

The archiving system includes also the documentation related to the explanation of the inventory compilation and calculation process. In the latest years an effort has been made by the inventory team in order to better document and explain the calculation process and data sources used and procedures applied during an annual cycle for each sector. The several documents produced are stored in the inventory IT area, enabling a smoother transmission of knowledge and facilitation the continuity of the inventory compilation process in case of changes within the inventory team.

1.4 General overview of methodologies and data sources used

Methodologies are consistent with the IPCC Guidelines (IPCC, 1997; IPCC, 2000; IPCC, 2003; IPCC, 2006) and EMEP/EEA Guidebooks (EMEP/CORINAIR, 2007; EMEP/EEA, 2009; EMEP/EEA, 2013; EMEP/EEA, 2016; EMEP/EEA 2019).

The table below gives an overview of the methodologies and emission factors used in the inventory. Default methods and emission factors used and the choice between Tier 1 and Tier 2 approaches, were case by case dictated by the availability of proper background information and from national circumstances.



Table 1.3: Summary of methods and emission factors (CRF summary 3 table)

GREENHOUSE GAS SOURCE AND SINK CATEGORIES	CO ₂		CH ₄		N ₂ O		HFCs		PFCs		SF ₆		Unspecified mix of HFCs and PFCs		NF ₃	
	Method applied	Emission factor	Method applied	Emission factor	Method applied	Emission factor	Method applied	Emission factor	Method applied	Emission factor	Method applied	Emission factor	Method applied	Emission factor	Method applied	Emission factor
1. Energy	NE,NO,T1,T2,T3	S,D,NE,NO,OTH,PS	CR,NO,OTH,T1,T2,T3	CR,D,NO,OTH,PS	O,OTH,T1,T2,T3	CR,D,NO,OTH,PS										
A. Fuel combustion	NE,NO,T1,T2,T3	S,D,NE,NO,OTH,PS	NO,T1,T2,T3	CR,D,NO,OTH,PS	O,OTH,T1,T2,T3	CR,D,NO,OTH,PS										
1. Energy industries	T1,T2,T3	CR,D,PS	T1,T2	CR,D	T1,T2	CR,D										
2. Manufacturing industries and construction	T1,T2,T3	CR,D,PS	T1,T2,T3	CR,D,PS	T1,T2,T3	CR,D,PS										
3. Transport	NE,T1,T2,T3	D,NE,OTH	T1,T2,T3	CR,D,OTH	OTH,T1,T2,T3	D,OTH										
4. Other sectors	NO,T1,T2	CS,D,NO	NO,T1,T2	D,NO,OTH	NO,T1,T2	D,NO,OTH										
5. Other	T1	D	T1	D	T1	D										
B. Fugitive emissions from fuels	D,NO	D,NO	CR,NO,OTH	CR,NO,OTH	D,NO	D,NO										
1. Solid fuels			NO	NO												
2. Oil and natural gas	D,NO	D,NO	CR,NO,OTH	CR,NO,OTH	D,NO	D,NO										
C. CO ₂ transport and storage																
2. Industrial processes	CR,NO,T1,T2,T3	R,CS,D,NO,OTH,PS	D,NO	CR,NO,OTH	D,T1	D,PS	NO,T2	D,NO	NO,T2	D,NO	NO,T1	NO	NO	NO	NO	NO
A. Mineral industry	T1,T3	OTH														
B. Chemical industry	NO	NO	D,NO	CR,NO,OTH	D	PS										
C. Metal industry	NO,T1,T3	D,NO,PS					NO	NO	NO	NO	NO	NO	NO	NO	NO	NO
D. Non-energy products from fuels and solvent use	CR,NO,T2	CR,CS,NO,OTH	NO	NO												
E. Electronic industry																
F. Product uses as ODS substitutes							NO,T2	D,NO	NO,T2	D,NO	NO	NO	NO	NO	NO	NO
G. Other product manufacture and use					T1	D	NO	NO	NO	NO	T1	NO	NO	NO	NO	NO
H. Other							NO	NO	NO	NO	NO	NO	NO	NO	NO	NO
3. Agriculture	T1	D	T1,T2	CS,D	T1,T2	CS,D										
A. Enteric fermentation			T1,T2	CS,D												
B. Manure management			T2	CS,D	T2	CS,D										
C. Rice cultivation			T1	CS,D												
D. Agricultural soils ⁽³⁾					T1,T2	CS,D										
E. Prescribed burning of savannas																
F. Field burning of agricultural residues			T1,T2	D	T1,T2	D										
G. Liming	T1	D														
H. Urea application	T1	D														
I. Other carbon-containing fertilizers																
J. Other																
4. Land use, land-use change and forestry	CS,D,T2	CS,D	D	D	D	D										
A. Forest land	CS,T2	CS,D	D	D	D	D										
B. Cropland			D	D	D	D										
C. Grassland			D	D	D	D										
D. Wetlands																
E. Settlements																
F. Other land																
G. Harvested wood products	D	D														
H. Other																
5. Waste	T1,T2	CS,D	T1,T2	CS,D	D,T1	CS,D										
A. Solid waste disposal			T2	CS,D												
B. Biological treatment of solid waste			T1	D	T1	D										
C. Incineration and open burning of waste	T1,T2	CS,D	T1	D	T1	D										
D. Waste water treatment and discharge			T2	CS,D	D	CS,D										
E. Other			T1	D	T1	D										

Use the following notation keys to specify the method applied:

D (IPCC default) **T1a, T1b, T1c** (IPCC Tier 1a, Tier 1b and Tier 1c, respectively) **CR** (CORINAIR) **M** (model)
RA (Reference Approach) **T2** (IPCC Tier 2) **CS** (Country Specific)
T1 (IPCC Tier 1) **T3** (IPCC Tier 3) **OTH** (Other)

If using more than one method within one source category, list all the relevant methods. Explanations regarding country-specific methods, other methods or any modifications to the default IPCC methods, as well as information regarding the use of different methods per source category where more
 Use the following notation keys to specify the emission factor used:

D (IPCC default) **CS** (Country Specific) **OTH** (Other)
CR (CORINAIR) **PS** (Plant Specific) **M** (model)



One of the primary sources of information used for the energy sector is the Energy Balances, produced annually by the General Direction of Energy (DGEG). The basic information for road transport, shipping and aviation, such as the number of vehicles, harbour statistics and aircraft landing and take-off cycles are provided to the APA, within the SNIERPA arrangements, from different national entities, such as the Institute of Mobility and Transports (IMT), the National Civil Aviation Authority (ANAC), the National Ports and different sectoral associations.

For the more recent years, data collected at APA under the European Emissions Trading Scheme (ETS) on production data, fuel consumption, fuel energy content and emission factors are also used in the inventory compilation. ETS data are used differently whenever the sectoral coverage is complete; or not, as ETS data do not always entirely cover the source categories whereas national statistics, such as the national energy balance, provide a more complete data set needed for the Portuguese emission inventory. Nevertheless, ETS data are used to develop plant-specific emission factors and check activity data levels.

Data sources for the industrial sector are diverse and include: annual production data from the IAPI (INE), ETS data, data collected from the National Pollutant Release and Transfer Register under the EC Regulation no.166/2006 and data collected directly from some plants or industrial associations.

The inventory considers, both for the energy and the industrial processes sectors, individual point sources based on detailed information, such as fuel consumption, from large point sources collected under the framework of the European Directive on Large Combustion Plants.

For sectors related to the use of products as substitutes for ODS, the inventory uses data from a national reporting tool (<https://formularios.apambiente.pt/GasesF/>) where national operators report the use of fluorinated gases, as proposed in article 6 of Regulation (EU) No. 517/2014 on fluorinated greenhouse gases and repealing Regulation (EC) No 842/2006.

The collection of data under the Large Combustion Plant Directive, the E-PRTR Regulation and Regulation (EU) No. 517/2014 on fluorinated greenhouse gases is also under the responsibility of APA and directly available to the inventory team.

Data sources for the agriculture sector rely, to a great extent, in the information provided by the INE on annual crop production and number of animals.

For the LULUCF sector, the forest areas and forest parameters are derived from national forest inventories provided by the Ministry of Agriculture/ICNF, which prepares also official information on the areas subject to fires. The cartographic products used in the compilation of Land Use and Land Use Change, are prepared by DGT.

Data on waste are collected annually at the APA via the Integrated System for Electronic Registry on Waste (SIRER) in the SILIAMB electronic platform.

The following table presents a summary of the activity data and sources used.



Table 1.4: Main data sources used in the Portuguese inventory

IPCC Sector	Activity Data	Data Sources
1 – Energy		
1 A – Energy. Fuel Combustion		
1A1 – Energy Industry	Fuel sales	Large Point Source Surveys (LPS) Large Combustion Plants (LCP) EDP Sustainability Annual Reports Energy Balance - General Directorate for Geology and Energy (DGEG) Autonomous Government of Azores National Statistical Institute (INE) European Emissions Trading Scheme - APA
1A2 - Manufacturing Industries and Construction		LPS, LCP, EPER/PCIP Energy Balance (DGEG) European Emissions Trading Scheme - APA
1A3 – Transport	Airport movements Vehicle sales Fuel sales Vehicle inspection data / Port movements	ANAC ACAP Energy Balance (DGEG) IMT
1A4 – Other Sectors	Fuel sales Equipments and fuel used	Energy Balance (DGEG) Survey on Energy Consumption in the Residential Sector (DGEG)
1A5 – Other	Fuel sales	Energy Balance (DGEG)
1 B – Fugitive Emissions from Fuels		Energy Balance and statistical yearbooks (DGEG) GALP
2 – IPPU		
2A - Mineral industry		LPS, LCP CIMPOR, SECIL Energy Balance (DGEG) Portuguese Association of Producers of Bitumen Materials (APORBET) European Asphalt Pavement Association (EAPA) Technology Centre for Ceramics and Glass (CTCV) European Emissions Trading Scheme (EU-ETS) – APA INE
2B - Chemical industry		Energy Balance (DGEG) LCP INE
2C - Metal industry		Energy Balance (DGEG) Worldsteel Association LCP INE SN
2D - Non-energy products from fuels and solvent use		Energy Balance (DGEG) Gen-Dir for Economic Activities (DGAE) INE ESIG
2E – Electronics Industry		IAPMEI ANIMEE
2F - Product uses as ODS substitutes		INE APIRAC Data from Industry Importers and Manufacturers EDP, REN Fluorinated Gas Reporting (APA)
2G - Other product manufacture and use		LCP Energy Balance (DGEG)
3 – Agriculture		
	Agriculture survey, Animal and Crop production, Fertilizer consumption	GPP IFAP INE APA
4 – Land Use, Land Use Change and Forestry		
	Biomass increment, Burnt area, Harvest Land use area, LUC Biomass increment	ICNF COS cartography (DGT) ISA
5 – Waste		
5A – Solid Waste Disposal on Land	Amount of Waste (Municipal) Amount of Waste (Industrial)	APA APA-INE
5B – Biological Treatment	Amount of Waste	APA
5C – Waste Incineration	Amount of Waste	APA
5D – Wastewater Handling	Industrial Production, Protein consumption	APA INE



1.5 Brief description of key source categories

Key category analysis to the 2023 Portuguese inventory estimates (1990-2021) was conducted using Approach 1 and Approach 2 with and without the LULUCF sector.

In accordance with the recommendations from the last UNFCCC review, the disaggregation level of the key category analysis intends to follow the guidance from 2006 IPCC.

Level assessment was undertaken for the base year and the latest reported inventory year; the trend assessment was performed for the 1990-2021 period. The analysis performed without LULUCF resulted in the identification of 37 key categories, listed in the following table.

More detailed information is presented in Annex E - Key Category Analysis of this report.

Table 1.5: Overview of key categories (without LULUCF) using Approach 1 and 2 for 1990 and latest inventory year

IPCC CATEGORIES	GHG	Key source Category Flag	Criteria for Identification	Current year emissions (kton CO ₂ eq.)
1.A.3.b Road Transportation	CO ₂	√	Level 1 and 2, Trend 1 and 2	15,174.7
1.A.1 Energy industries - Gaseous fuels	CO ₂	√	Level 1 and 2, Trend 1 and 2	5,429.7
1.A.2 Manufacturing industries and construction - Gaseous fuels	CO ₂	√	Level 1, Trend 1 and 2	4,167.2
3.A Enteric fermentation	CH ₄	√	Level 1, Trend 1	4,063.9
5.A Solid waste disposal	CH ₄	√	Level 1 and 2, Trend 1 and 2	3,855.6
2.F.1 Refrigeration and Air Conditioning	Fgases	√	Level 1 and 2	3,018.9
1.A.2 Manufacturing industries and construction - Liquid fuels	CO ₂	√	Level 1 and 2, Trend 1 and 2	2,637.0
1.A.4 Combustion Other Sectors - Liquid fuels	CO ₂	√	Level 1, Trend 1	2,591.3
2.A.1 Mineral Industry - Cement production	CO ₂	√	Level 1 and 2, Trend 1 and 2	2,105.9
1.A.1 Energy industries - Liquid fuels	CO ₂	√	Level 1 and 2, Trend 1 and 2	1,562.4
3.D.1 Direct N ₂ O Emissions From Managed Soils	N ₂ O	√	Level 1 and 2	1,551.6
1.A.4 Combustion Other Sectors - Gaseous fuels	CO ₂	√	Level 1, Trend 1	1,424.4
3.B Manure Management	CH ₄	√	Level 1	838.3
1.B.2.a Fugitive emissions - Oil	CO ₂	√	Level 1 and 2, Trend 1 and 2	819.2
5.D Wastewater treatment and discharge	CH ₄	√	Level 1 and 2, Trend 1 and 2	769.1
1.A.1 Energy industries - Solid fuels	CO ₂	√	Level 1 and 2, Trend 1 and 2	690.6
2.B.8 Chemical Industry - Petrochemical and Carbon Black production	CO ₂	√	Level 1 and 2	637.5
1.A.1 Energy industries - Other fossil fuels	CO ₂	√	Level 1 and 2, Trend 1 and 2	409.7
3.D.2 Indirect N ₂ O Emissions From Managed Soils	N ₂ O	√	Level 1	387.4
2.A.2 Mineral Industry - Lime production	CO ₂	√	Level 1 and 2, Trend 2	386.6
1.A.3.a Civil (domestic) aviation	CO ₂	√	Level 1 and 2, Trend 2	340.1
1.A.2 Manufacturing industries and construction - Other fossil fuels	CO ₂	√	Level 1, Trend 2	304.9
2.A.4 Mineral Industry - Other Process Uses of Carbonates	CO ₂	√	Level 1	258.3
1.A.4 Combustion Other Sectors - Biomass	CH ₄	√	Level 1	236.6
1.A.3.d Domestic navigation - Residual fuel oil	CO ₂	√	Level 2	207.1
2.D Non-energy products from fuels and solvent use	CO ₂	√	Level 2	205.2
3.C Rice cultivation	CH ₄	√	Level 2	175.8
5.D Wastewater treatment and discharge	N ₂ O	√	Level 2	168.5
5.B Biological treatment of solid waste	CH ₄	√	Level 2, Trend 2	88.2
1.A.1 Energy industries - Gaseous fuels	N ₂ O	√	Trend 2	65.0
2.C.1 Metal Industry - Iron and Steel production	CO ₂	√	Level 1, Trend 1 and 2	65.0
1.B.2.b Fugitive emissions - Natural Gas	CH ₄	√	Level 2, Trend 2	58.6
1.A.2 Manufacturing industries and construction - Solid fuels	CO ₂	√	Level 1 and 2, Trend 1 and 2	56.4
5.B Biological treatment of solid waste	N ₂ O	√	Trend 2	43.5
5.C Incineration and open burning of waste	CO ₂	√	Level 2, Trend 2	36.9
2.B.2 Chemical Industry - Nitric acid production	N ₂ O	√	Level 1, Trend 1	33.2
1.B.1.Fugitive emissions – Solid Fuels	CH ₄	√	Level 2, Trend 2	17.0

Including the LULUCF sector in the analysis, 46 categories were identified, as shown in the next table.



Table 1.6: Overview of key categories (with LULUCF) using Approach 1 and 2 for 1990 and latest inventory year

	GHG	Key source Category Flag	Criteria for Identification	Current year emissions (kton CO2 eq.)
1.A.3.b Road Transportation	CO2	v	Level 1 and 2, Trend 1 and 2	15,174.7
1.A.1 Energy industries - Gaseous fuels	CO2	v	Level 1, Trend 1 and 2	5,429.7
1.A.2 Manufacturing industries and construction - Gaseous fuels	CO2	v	Level 1, Trend 1	4,167.2
3.A Enteric fermentation	CH4	v	Level 1, Trend 1	4,063.9
5.A Solid waste disposal	CH4	v	Level 1 and 2, Trend 1 and 2	3,855.6
2.F.1 Refrigeration and Air Conditioning	Fgases	v	Level 1 and 2	3,018.9
1.A.2 Manufacturing industries and construction - Liquid fuels	CO2	v	Level 1 and 2, Trend 1 and 2	2,637.0
1.A.4 Combustion Other Sectors - Liquid fuels	CO2	v	Level 1	2,591.3
2.A.1 Mineral Industry - Cement production	CO2	v	Level 1 and 2, Trend 1	2,105.9
1.A.1 Energy industries - Liquid fuels	CO2	v	Level 1 and 2, Trend 1 and 2	1,562.4
3.D.1 Direct N2O Emissions From Managed Soils	N2O	v	Level 1 and 2, Trend 1 and 2	1,551.6
1.A.4 Combustion Other Sectors - Gaseous fuels	CO2	v	Level 1, Trend 1	1,424.4
3.B Manure Management	CH4	v	Level 1	838.3
1.B.2.a Fugitive emissions - Oil	CO2	v	Level 1 and 2, Trend 1 and 2	819.2
5.D Wastewater treatment and discharge	CH4	v	Level 1 and 2, Trend 1 and 2	769.1
1.A.1 Energy industries - Solid fuels	CO2	v	Level 1 and 2, Trend 1 and 2	690.6
2.B.8 Chemical Industry - Petrochemical and Carbon Black production	CO2	v	Level 1	637.5
1.A.1 Energy industries - Other fossil fuels	CO2	v	Level 1 and 2, Trend 1 and 2	409.7
3.D.2 Indirect N2O Emissions From Managed Soils	N2O	v	Level 1	387.4
2.A.2 Mineral Industry - Lime production	CO2	v	Level 1 and 2, Trend 1 and 2	386.6
4(IV) Indirect nitrous oxide (N2O)	N2O	v	Level 1	385.5
4.D.2 Land converted to Wetlands	CO2	v	Level 1	371.3
1.A.3.a Civil (domestic) aviation	CO2	v	Level 1 and 2	340.1
1.A.2 Manufacturing industries and construction - Other fossil fuels	CO2	v	Level 1, Trend 1	304.9
2.A.4 Mineral Industry - Other Process Uses of Carbonates	CO2	v	Level 1	258.3
4.B.2 Land converted to Cropland	CO2	v	Level 1 and 2	247.5
1.A.4 Combustion Other Sectors - Biomass	CH4	v	Level 1	236.6
2.D Non-energy products from fuels and solvent use	CO2	v	Level 2	205.2
4.A.1. Forest land remaining Forest land	CH4	v	Level 1	196.5
3.C Rice cultivation	CH4	v	Level 2	175.8
5.D Wastewater treatment and discharge	N2O	v	Level 2, Trend 2	168.5
4.E.2 Land converted to Settlements	CO2	v	Level 1 and 2, Trend 2	95.7
5.B Biological treatment of solid waste	CH4	v	Level 2, Trend 2	88.2
2.C.1 Metal Industry - Iron and Steel production	CO2	v	Level 1, Trend 1	65.0
1.B.2.b Fugitive emissions - Natural Gas	CH4	v	Level 2, Trend 2	58.6
1.A.2 Manufacturing industries and construction - Solid fuels	CO2	v	Level 1, Trend 1	56.4
5.C Incineration and open burning of waste	CO2	v	Level 2	36.9
4.C.1. Grassland remaining Grassland	CH4	v	Level 2	36.9
2.B.2 Chemical Industry - Nitric acid production	N2O	v	Level 1, Trend 1	33.2
1.B.1.Fugitive emissions - Solid Fuels	CH4	v	Level 2, Trend 2	17.0
4.G. Other (Harvested Wood Products)	CO2	v	Level 1, Trend 1	-253.1
4.C.2 Land converted to Grassland	CO2	v	Level 1 and 2, Trend 1 and 2	-677.5
4.A.1. Forest land remaining Forest land	CO2	v	Level 1 and 2, Trend 1 and 2	-877.3
4.A.2 Land converted to Forest land	CO2	v	Level 1 and 2, Trend 1	-1,663.0
4.B.1. Cropland remaining Cropland	CO2	v	Level 1 and 2, Trend 1 and 2	-1,914.3
4.C.1. Grassland remaining Grassland	CO2	v	Level 1 and 2, Trend 1 and 2	-2,203.3

1.6 Information on QA/QC

Quality Assurance (QA) and Quality Control (QC) and verification activities are integral parts of the inventory system aiming to support the development of the national inventory of greenhouse gas emissions.

APA has the overall responsibility for the national inventories in Portugal, including the competence for the coordination of the QA/QC System.

The QA/QC system is composed of several main elements, in particular:

- Designation of an inventory compiler who is also responsible for coordinating QA/QC and verification activities and definition of roles/responsibilities within the inventory;
- QA/QC plan;
- Procedures Manual defining General QC procedures that apply to all inventory categories and Category-specific QC procedures, QA and review procedures;
- Verification activities;
- Reporting, documentation, and archiving procedures.



A QC system is designed to provide routine and consistent checks to ensure data integrity, correctness, and completeness, aiming to identify and address errors and omissions; it also includes procedures to document and archive the inventory material and record all QC activities.

In this context APA elaborated a new QA/QC procedures manual, describing QA/QC procedures and verification activities to be followed during the inventory compilation and aiming at the inventory improvement. This QA/QC procedures manual is based on the QA/QC requirements set out in the 2006 IPCC Guidelines.

QC procedures defined in the QA/QC Manual include a series of checklists, which consider basic checks on the accuracy of data acquisition processes (including, e.g. transcription errors) and checks on calculation procedures, data and parameters. It includes also cross-checking among subcategories in terms of data consistency, verification of NIR and CRF tables.

Documentation and archiving procedures include checks on information handling which should enable the recalculation of the inventory. All the documents and electronic files used for the inventory preparation are stored at the APA. All information relating to the planning, preparation, and management of inventory activities should be documented and archived, including:

- Responsibilities, institutional arrangements, and procedures for the planning, preparation, and management of the inventory process;
- Assumptions and criteria for the selection of activity data and emission factors;
- Emission factors and other estimation parameters used, including references to the IPCC document for default factors or to published references or other documentation for emission factors used in higher tier methods;
- Activity data or sufficient information to enable activity data to be traced to the referenced source;
- Information on the uncertainty associated with activity data and emission factors;
- Rationale for choice of methods;
- Methods used, including those used to estimate uncertainty and those used for recalculations;
- Changes in data inputs or methods from previous inventories (recalculations);
- Identification of individuals providing expert judgement for uncertainty estimates and their qualifications to do so;
- Electronic databases or software used in the production of the inventory, including versions,
- Worksheets for category estimates calculation;
- Inventory reports and any analysis of trends;
- QA/QC plans and outcomes of QA/QC procedures.

Routine general checks, source specific quality control procedures should be applied on a case by case basis focusing on key categories and on categories where significant methodological and data revision have taken place or on new sources.

QA/QC procedures are to be applied by the inventory team during the inventory calculation and compilation following a yearly defined QA/QC plan.

A QA/QC coordinator is designated annually in order to ensure that the objectives of the QA/QC plan are met and to guarantee the good implementation of the QA/QC procedures defined.

The inventory staff is responsible for the implementation of QA/QC procedures related to data gathering, handling, processing, documenting, archiving and reporting procedures related to the inventory.



Other procedures include technical verifications of emission factors, activity data, and comparison of results among different approaches, and also comparisons between national data and international databases, and emission intensity indicators among countries, having as a basis information compiled by the EC and the UNFCCC.

Each Involved Entity (IE) within the Portuguese national system (SNIERPA) contributing with data to the inventory is responsible for the quality of their own data.

The sectoral Focal Points within SNIERPA have also an important role in the implementation of QA\QC activities. As foreseen in the implementing procedures document agreed under SNIERPA, APA transmits the reports to the focal points on each official submission for validation purposes of each sectoral component and proposed amendments and perform QA\QC validation procedures.

Quality assurance activities also include feedback from different inventory users and checks and reviews made under the EC and UNFCCC.

Among these are consistency data checks performed in the context of the Regulation (EU) No 2018/1999 of on the Governance of the Energy Union and Climate, which requires EU Member States to report in textual and tabular format data on inconsistencies. Other checks refer to consistency comparisons that should be done among data on air pollutants reported under Directive (EU) 2016/2284 are consistent with the corresponding emission estimates reported under the Regulation (EU) 2018/1999. When the differences exceed $\pm 5\%$ between the total emissions for a specific pollutant an explanation should be provided. Another important check done consists on the comparison of emissions estimated under Regulation (EU) 2018/199 with data reported under the EU emissions trading scheme (ETS). Furthermore, a comparison between the reference approach calculated on the basis of the data included in the GHG inventory and the reference approach calculated on the basis of the data reported pursuant to Article 4 and Annex B to Regulation (EC) No 1099/2008 on energy statistics, should be realised. Differences of more than $\pm 2\%$ in the total national apparent fossil fuel consumption at aggregate level for all fossil fuel categories, should be reported.

The results of quality control of national submissions under the Commission Implementing Regulation (EU) 2020/1208 on structure, format, submission processes and review of information (e.g. completeness checks, consistency checks), and the issues raised during the annual review process of the UNFCCC or other reviews in the context of the European Effort Sharing Decision (ESD) and the National Emission Ceilings Directive (NECD), constitute additional processes of technical verification and represent valuable sources of error detection and methodological improvement.

Inventory data users, such as people from universities, from regional departments or other interested entities, or interactions and feedback received from external teams involved in the preparation of the Climate Change Plans, Climate Road maps or more recently the 2050 Road map for Carbon Neutrality, as well as Air Emissions Reduction Plans are also valuable instruments that have been used to improve the quality of the Portuguese inventory.

1.7 General uncertainty evaluation, including data on the overall uncertainty for the inventory totals

The Portuguese uncertainty analysis follow Approach 1, based on the error propagation equations, proposed by the 2006 IPCC Guidelines.

Despite the efforts done in order to cover all the categories considered in the inventory, it was not yet possible to include HWP and indirect CO₂ in the uncertainty analysis.



The uncertainty values, both for activity data and emission factors, are discussed in the detailed analysis of emission estimates for each individual source sector.

A more detailed information on Tier 1 uncertainty calculation per category and pollutant can be found in Annex F of this report.

For the 2021 total emission estimates without indirect CO₂, an uncertainty of 7.8 % is estimated. The uncertainty in trend from 1990 to 2021 is 7.1 %.

Total uncertainty varies along the years from a maximum value of 18 % to lower values (6%). Uncertainty values are defined as the range of 95 % confidence interval (IPCC, 1997; IPCC, 2000, IPCC, 2006), meaning that there is a 95 % probability that the actual value of the quantity (activity data, emission factor or emission) is within the interval defined by the confidence limits.

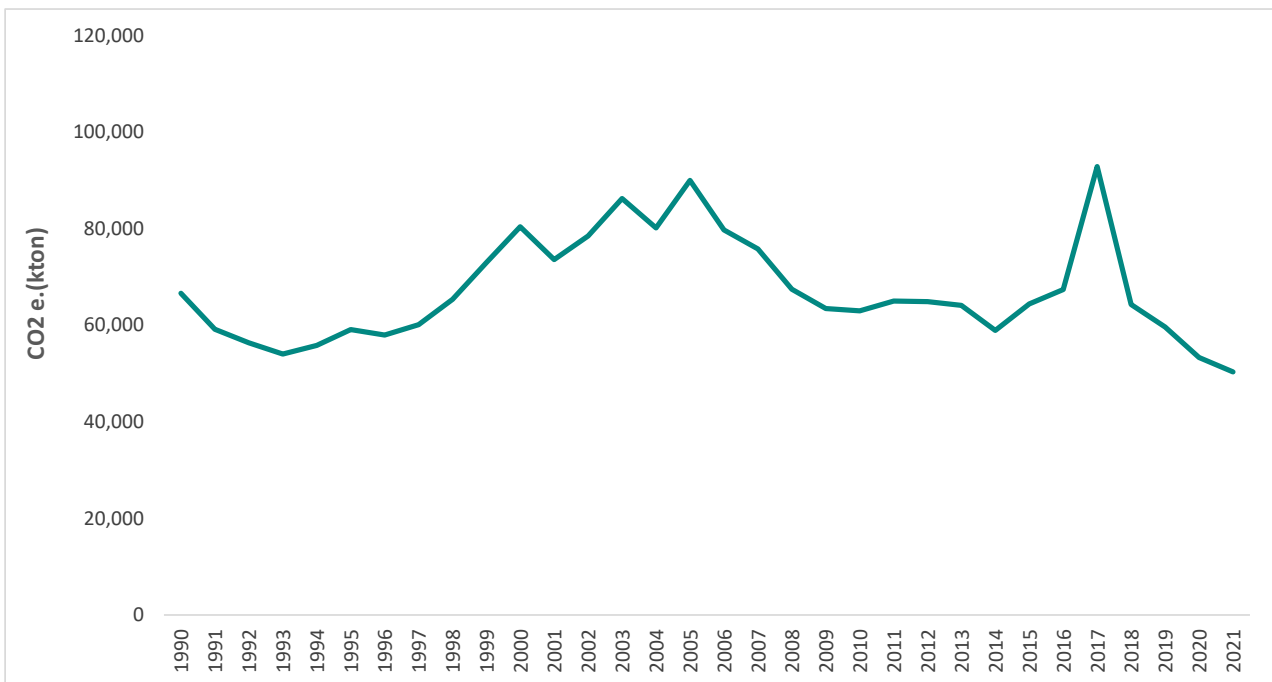

Figure 1.6: Trend of total GHG emissions with LULUCF and lower and upper estimates considering the 95 % confidence interval

1.8 Overview of the completeness

The inventory covers the gaseous air pollutants included in Annex A to the Kyoto Protocol: carbon dioxide (CO₂), methane (CH₄), nitrous oxide (N₂O), hydrofluorocarbons (HFC), perfluorocarbons (PFCs) and sulphur hexafluoride (SF₆), as well as estimates for indirect GHGs, including carbon monoxide (CO), nitrogen oxides (NO_x), and non-methane volatile organic compounds (NMVOC). Data are also reported for sulphur oxides (SO_x). NF₃ emissions do not occur in Portugal.

As a general rule the inventory covers emissions realized in the whole Portuguese territory, i.e., mainland Portugal and the two autonomous regions of Madeira and Azores Islands.



1.9 Reporting on consistency of the reported data on air pollutants (CO, SO₂, NO_x and NMVOC)

As specified in Annex V of Regulation (EU) 2018/1999, Member States are required to report on the results of the checks between emissions estimates of carbon monoxide (CO), sulphur dioxide (SO₂), nitrogen oxides (NO_x) and volatile organic compounds, in inventories submitted under Directive (EU) 2016/2284 of the European Parliament and of the Council of 14 December 2016 and under the UNECE Convention on Long-range Transboundary Air Pollution, and the corresponding emission estimates in greenhouse gas inventories under Regulation (EU) 2018/1999.

The next figure presents the results of the assessment made using the latest submission (15th March 2023) under the NECD (Directive (EU) 2016/2284 of the European Parliament and of the Council (<http://cdr.eionet.europa.eu/pt/eu/nec/envvoqlvw/>)) and data provided in this submission.

The differences are the result in geographical coverage between submissions. The NECD refers to Portugal Mainland and the EU Governance Regulation/UNFCCC submissions refer to the national total which includes the two Autonomous Regions of Azores and Madeira.

The differences for NMVOC and CO emissions are in the range below 5 %. Differences for NO_x are related to industry related sectors and to the transport sector.

For SO₂, the disparities are more significant in particular after 2007. The difference in SO₂ after 2007 is the result of the implementation of the abatement systems (desulfurization in two Large Point Source Coal Energy Plants) in Mainland Portugal. In the latest years, however, the use of coal in thermal production has been phased-down and was definitively phased-out at the end of 2021 with the closure of the last Portuguese coal thermal plant (Sines in Mainland). At present, natural gas is the main fuel used in electric thermal generation in Mainland, while in the two Autonomous Regions of Azores and Madeira, electrical generation is based on heavy fuel and diesel thermal plants.

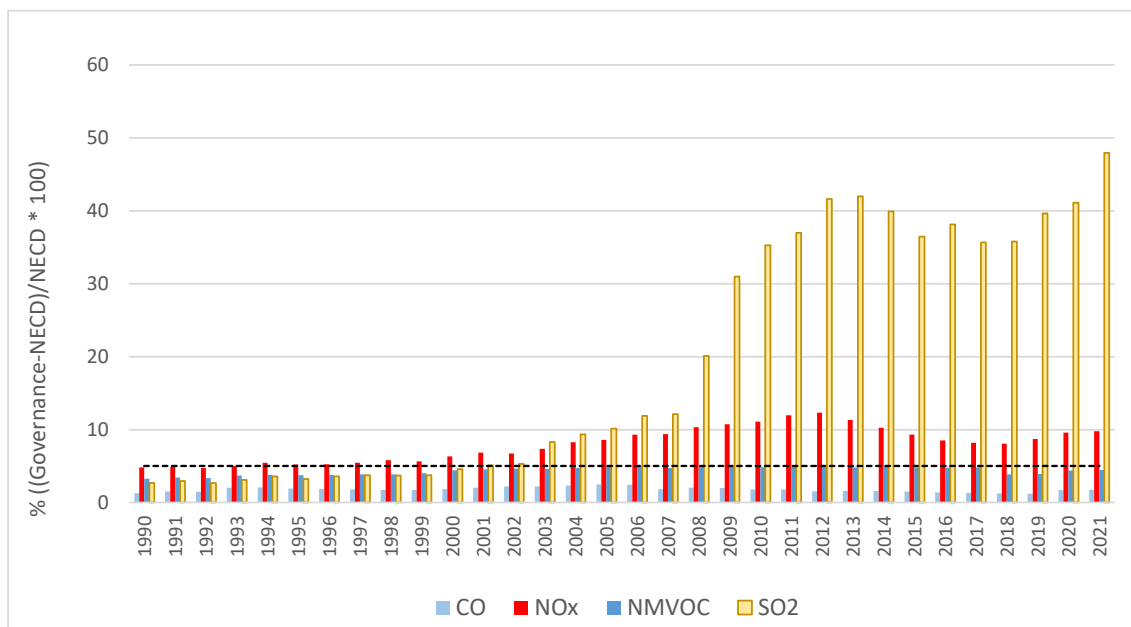

Figure 1.7: Comparison between MMR and NECD estimates on air pollutants



1.10 Comparison of the sectoral approach with the reference approach

Point (j)(iii) of Part 1 of Annex V to Regulation (EU) 2018/1999, defines that Member States shall report information on the comparison between the sectoral approach used in the greenhouse gas inventory and the reference approach calculated on the basis of the data reported pursuant to Article 4 of, and Annex B to, Regulation (EC) No 1099/2008 on energy statistics.

In the assessment made for this submission, significant differences were found (of more than $\pm 2\%$ in the total national apparent fossil fuel consumption) for the years 1996, 1997, 1998 and 2013, that result from some missing information and other possible factors which require further development. The difference between sectoral and reference approaches is -1.65% for 2021.

It is noted the improvement of the comparison exercise between the reference approach and the sectoral approach, namely in terms of the PDM, working together with the national energy authority (DGEG) in order to clarify the origin of these differences.

1.11 Future developments

Future improvements are defined for each sector by the relevant inventory compiler and put together in a PDM which is settled/updated each year. The most relevant issues are discussed in the context of the SNIERPA and the methodological developments and improvements are performed under the responsibility of the APA in cooperation with the sectoral Focal Points.

The PDM intends to reflect the results of the various review processes, in particular the UNFCCC reviews, the annual inventory compilation process (all experts and entities involved can make proposals for methodological development), and generally the outcomes of the application procedures of Quality Control and Quality Assurance, taking into account the results of the key category assessment.

2 Trends in Portuguese GHG Emissions

Table of Contents

2	Trends in Portuguese GHG Emissions.....	2-1
2.1	Trends of Total Emissions.....	2-2
2.2	Emissions by Gas.....	2-6
2.3	Emissions by Sector	2-9
2.4	Indirect GHG and SO _x emissions	2-13

List of Figures

Figure 2.1:	GHG emissions.....	2-2
Figure 2.2:	Hydraulic index.....	2-3
Figure 2.3:	GHG emissions per capita, per unit of GDP and energy consumption.....	2-4
Figure 2.4:	GHGs emissions percentage change (2020-2021) by IPCC category (LULUCF excluded)	2-5
Figure 2.5:	Gross electric power production, electric import balance and emissions from electricity and heat generation	2-5
Figure 2.6:	Primary energy consumption by energy source.....	2-6
Figure 2.7:	GHG emissions by gas.....	2-6
Figure 2.8:	Change of GHG emissions by gas over the period 1990-2021	2-7
Figure 2.9 -	GHG emissions in Portugal by sector (LULUCF excluded)	2-9
Figure 2.10:	GHG emissions and removals by sector	2-10
Figure 2.11:	GHGs emissions percentage change (1990-2021) by IPCC category (LULUCF excluded)	2-11
Figure 2.12:	Indirect GHG and SO _x emissions: 1990-2021 variation	2-13

List of Tables

Table 2.1:	GHG emissions and removals in Portugal by gas.....	2-8
Table 2.2:	GHG emissions and removals by sector	2-12
Table 2.3:	Indirect GHG and SO _x emissions: 1990-2021	2-15



2 Trends in Portuguese GHG Emissions

Updated: March 2023

2.1 Trends of Total Emissions

In 2021, total Portuguese GHG emissions, including indirect CO₂, without land-use, land-use change and forestry (LULUCF) were estimated at about 56.5 Mt CO₂e, representing a decrease of 5.1 % compared to 1990 levels and a decrease of 2.8 % compared to the previous year (2020).

When considering the LULUCF sector, the national level of emissions in 2021 totalled 50.5 Mt CO₂e., corresponding to a 24.3 % decrease in relation to 1990 and a variation of -5.5 % from 2020 to 2021.

Throughout this report, emissions values are presented in CO₂e using IPCC AR5 GWP values.

The reference to “total emissions” along the report is meant to refer to “total emissions without LULUCF, including CO₂ indirect emissions”.

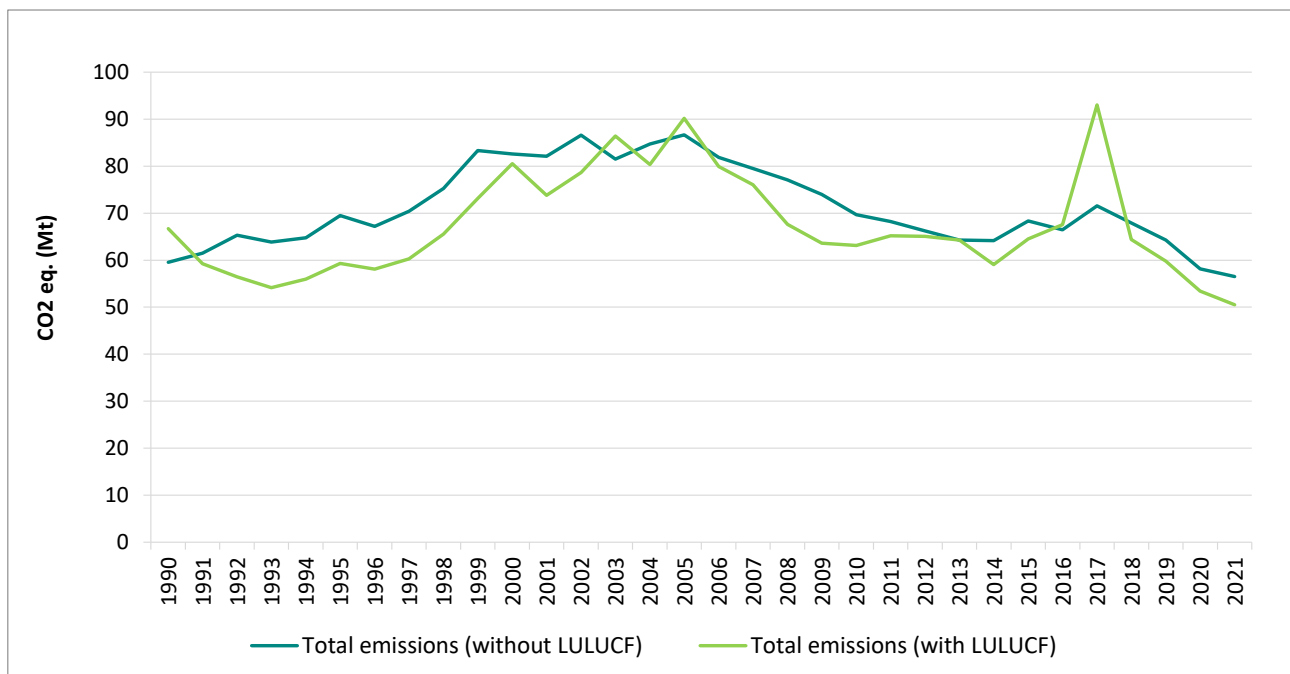

Figure 2.1: GHG emissions

National emissions developed rapidly during the 1990s, reflecting the evolution of the Portuguese economy, which was characterized by a strong growth associated with increased energy demand and mobility.

In the early 2000s, the growth of emissions has been more moderate and started to stagnate, registering thereafter, in particular after 2005, a decrease. This reduction is the result of the implementation of several measures such as the replacement of more polluting energy sources such as fuel oil with natural gas (introduced since 1997), the implementation of combined cycle power plants to NG (1999), the progressive installation of cogeneration units, the improvement of energy and technological efficiency of industrial processes, improvements in automobile efficiency (fleet renewal), and the improvement of fuels quality, among others.



These measures were accompanied by a continuous decline in energy consumption (both primary and final) verified in the country since 2005, with a significant expression in the period 2009-2013, fact that may be also explained by the internal economic recession, along with the European economic and financial crisis.

These years registered a slowdown of industrial activity and the cessation of some activities in the country such as black carbon production in 2013 and the production of ammonia in 2009, with the relocation of the production facilities.

In 2014 there was an inversion of this pattern. The evolution of the primary and, in particular, the final energy consumption trend increased, accompanying the positive evolution of the Portuguese economy.

The level of emissions shows, however, significant inter-annual variations, which are mostly occurring in the energy sector and are mainly related to the pronounced fluctuations of hydroelectric power generation that is highly affected by annual variations in precipitation (figure below).

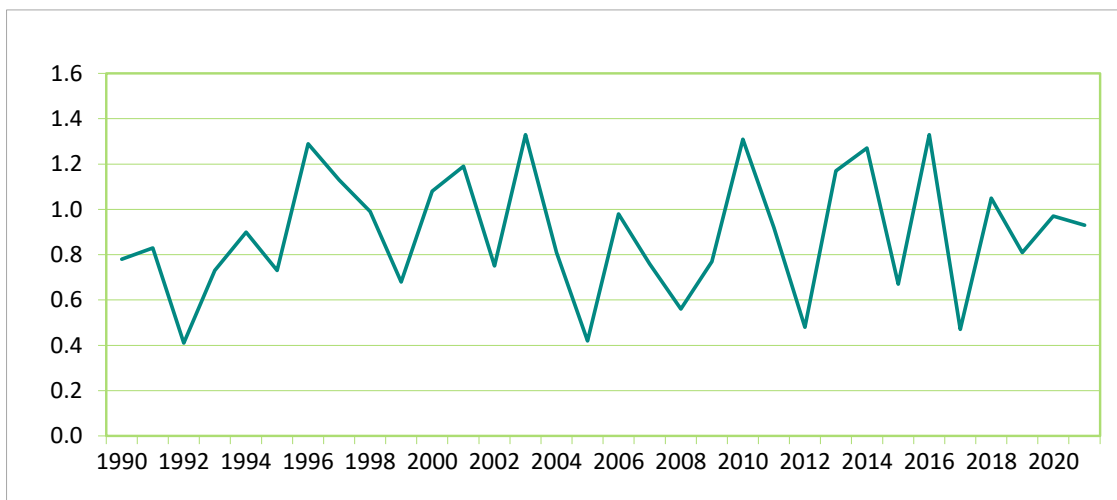

Note: HI = 1 corresponds to the average hydrologic availability.

Source: EDP, REN

Figure 2.2: Hydraulic index

The decrease of carbon intensity (GHG emissions per GDP unit) which is observed since the mid-2000s (following figure), has been accentuated in the most recent years and is in part related to the expressive development of renewable energy sources (mainly wind and hydro) in electricity production.

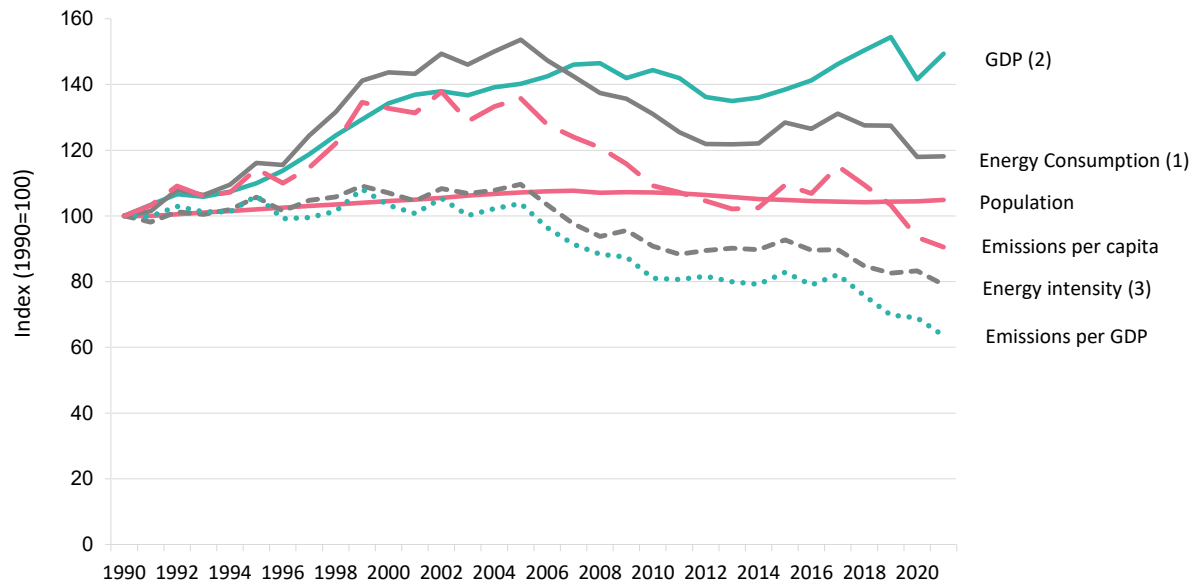

Notes: (1) Primary Energy Consumption; (2) GDP at 2016 prices; (3) Energy Consumption per GDP

Sources: INE, DGEG

Figure 2.3: GHG emissions per capita, per unit of GDP and energy consumption

After the abrupt economic slowdown verified in 2020 due to the COVID-19 shutdown measures to contain the pandemic, GDP registered in 2021 a positive variation of 5.5 %.

The primary energy consumption, which decreased by 8 % in 2020 compared to 2019 reflecting the economic effects of the pandemic, maintained in 2021 approximately the same level as 2019, representing an improvement in the energy intensity of the economy with a greater wealth created by unit of primary energy consumed.

Total emissions decreased 2.8 % in 2021 as compared to 2020.

This reduction is related to a great extent to the downward trend registered in the energy sector, which globally presents a reduction in emissions of 4.1 % compared to 2020. This variation is explained essentially by the decrease of emissions from electricity production, which registered a drop of 22.2 % of the emissions compared to the previous year. With the exception of transport, which grew 7.3 % compared to 2020, all other sub-categories reduced their emissions in 2021. The decline of emissions in 2021 is particularly significant as the year 2020 represented an exceptional year in terms of reduced emissions related to the consequences of the COVID-19 pandemic outbreak on the activity of companies and individuals.

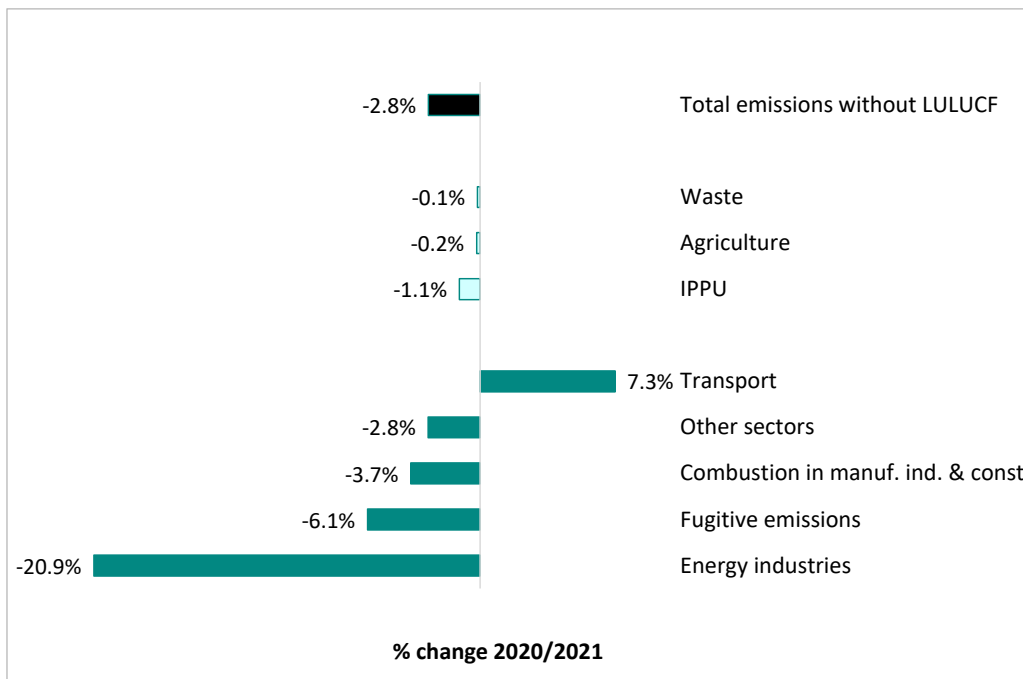
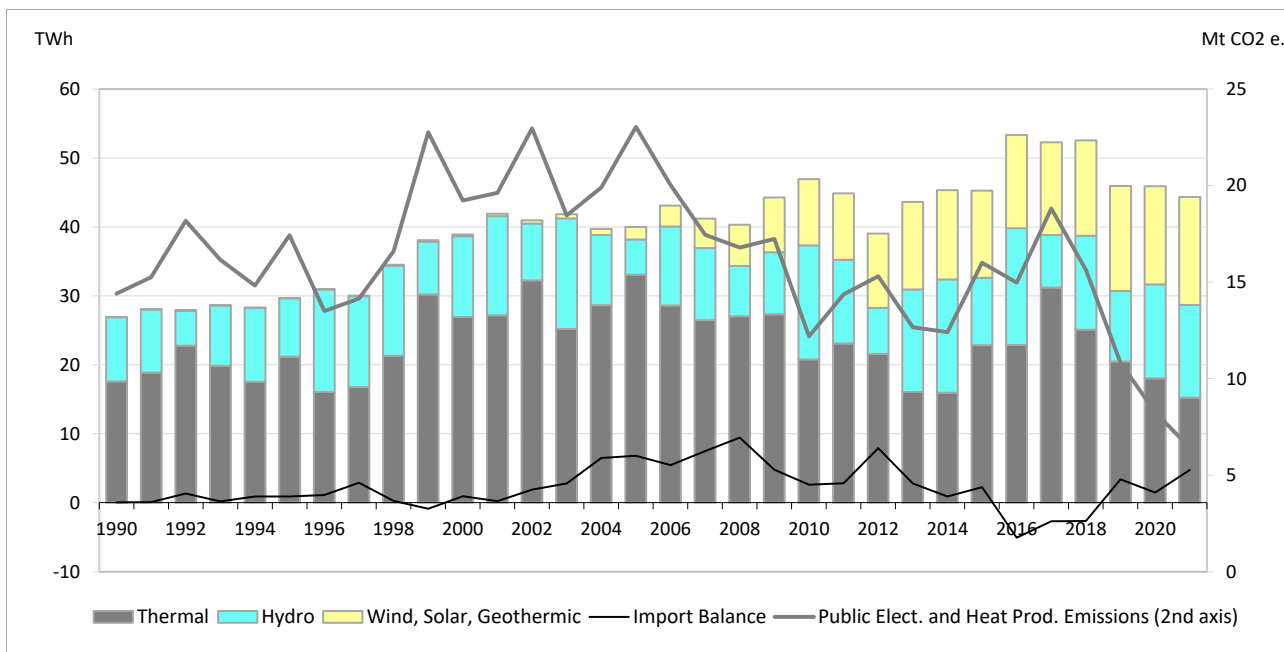

Figure 2.4: GHGs emissions percentage change (2020-2021) by IPCC category (LULUCF excluded)

In 2021, the renewable domestic production increased approx. 5% over the previous year as a result of a balance between a less favourable hydraulic availability (IH = 0.93 compared to 0.97 in 2020) and a smaller hydroelectric production (-1 %), and an increase in the photovoltaic production (+30 %) and an increase of biomass use in electricity production (+6 %).



Source: DGEG

Figure 2.5: Gross electric power production, electric import balance and emissions from electricity and heat generation

The analysis of the consumption of different energy sources in 2021 shows that Oil remains the main primary energy supply, followed by Renewables and Natural Gas. The relevance of Oil relates to the transport sector, particularly to road transport, and its use in the petrochemical industry.



Nevertheless, the weight of Oil has decreased over the years (66 % in 1990 vs. 41 % in 2021) whereas that of Renewables has increased (18 % in 1990 vs. 31 % in 2021). Natural gas, non-existing in 1990, represents 24 % in 2021.

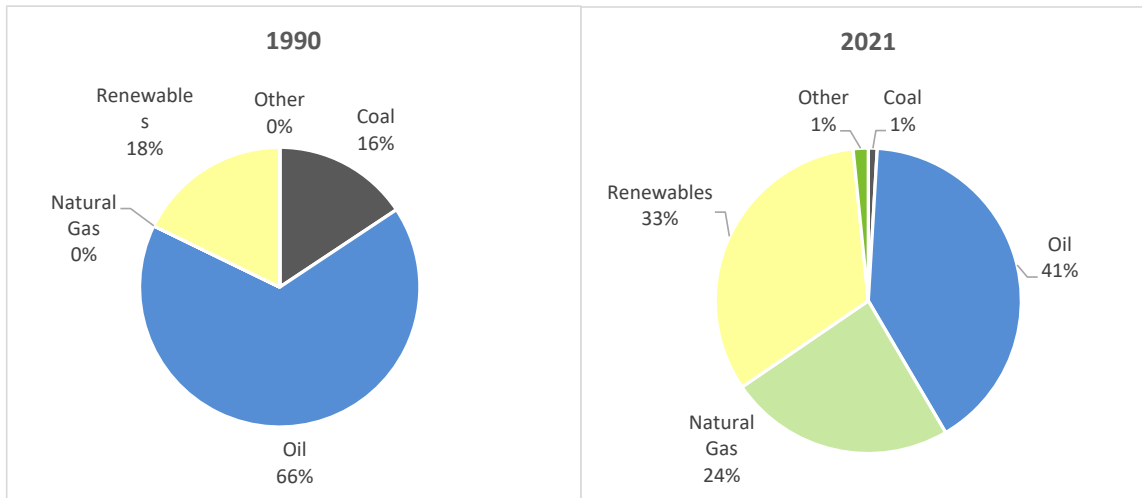

Source: DGEG

Figure 2.6: Primary energy consumption by energy source

2.2 Emissions by Gas

The figure below illustrates the relative contribution of direct GHG to the total emissions for 1990 and 2021, showing CO₂ as the primary GHG, accounting for about 71 % of Portuguese emissions on a carbon equivalent basis in 2021 (LULUCF excluded). The second most important gas is CH₄, followed by N₂O, representing, respectively, 18 % and 5 % of total emissions in 2021. Portugal has chosen 1995 as the base year for fluorinated gases. In 2021, these gases represented about 6 % of total GHG emissions. NF₃ emissions are non-occurring in Portugal.

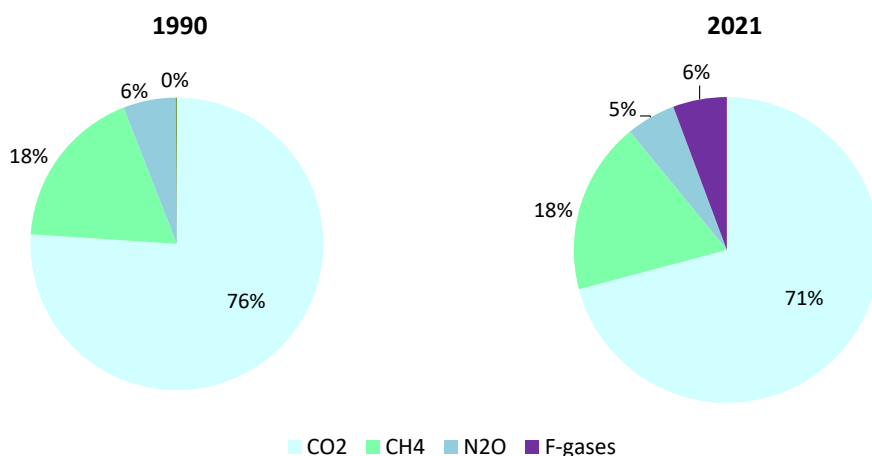

Figure 2.7: GHG emissions by gas

Over the 1990-2021 period, the three gases CO₂, CH₄ and N₂O registered a reduction. F-gases that have significantly increased in importance, particularly in latest years (more than +4000 % since 1995), are excluded from the following figure.

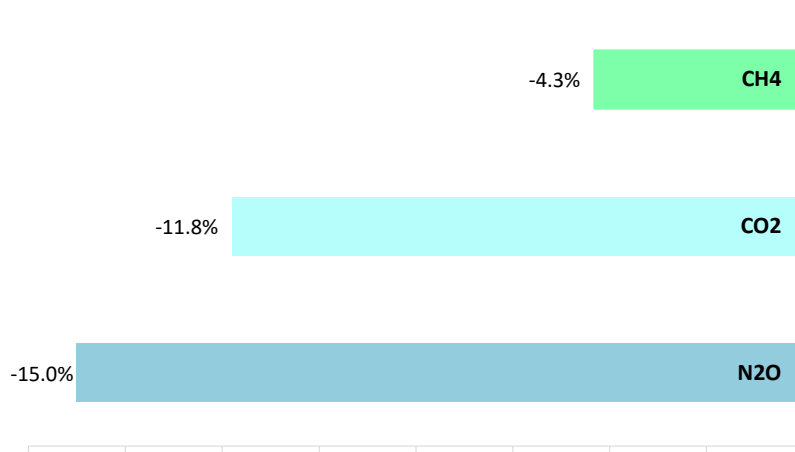

Figure 2.8: Change of GHG emissions by gas over the period 1990-2021



Table 2.1: GHG emissions and removals in Portugal by gas

GHGs EMISSIONS	1990	1991	1992	1993	1994	1995	1996	1997	1998	1999	2000	2001	2002	2003	2004	2005
	CO₂ equivalent (Gg)															
CO2 emissions without net CO2 from LULUCF	45,279	47,097	50,920	49,434	50,207	54,468	51,761	54,627	59,169	66,837	65,611	65,152	69,560	64,456	67,303	69,635
CO2 emissions with net CO2 from LULUCF	50,984	43,961	41,557	39,256	40,763	43,553	42,143	44,057	48,847	56,121	62,678	56,019	60,730	67,548	62,081	71,411
CH4 emissions without CH4 from LULUCF	10,736	10,873	10,928	10,994	11,138	11,313	11,521	11,736	11,961	12,228	12,453	12,450	12,473	12,479	12,473	12,396
CH4 emissions with CH4 from LULUCF	11,554	11,282	11,020	11,078	11,323	11,582	11,645	11,776	12,093	12,265	12,762	12,668	12,770	13,472	12,673	13,258
N2O emissions without N2O from LULUCF	3,458	3,428	3,395	3,318	3,308	3,456	3,636	3,683	3,712	3,805	3,978	3,855	3,752	3,620	3,885	3,443
N2O emissions with N2O from LULUCF	4,073	3,924	3,799	3,719	3,740	3,912	4,072	4,116	4,194	4,281	4,556	4,429	4,371	4,464	4,521	4,294
HFCs	NO,NA	NO,NA	NO,NA	NO,NA	NO,NA	54	79	138	200	281	360	462	589	720	829	985
PFCs	NO,NA	NO,NA	NO,NA	NO,NA	NO,NA	NO,NA	NO,NA	0	0	1	1	2	2	2	3	3
Unspecified mix of HFCs and PFCs	NO,NA	NO,NA	NO,NA	NO,NA	NO,NA	NO,NA	NO,NA	NO,NA	NO,NA	NO,NA	NO,NA	NO,NA	NO,NA	NO,NA	NO,NA	NO,NA
SF6	NO,NA	NO,NA	NO,NA	NO,NA	NO,NA	14	15	16	16	17	17	18	19	22	27	27
NF3	NO,NA	NO,NA	NO,NA	NO,NA	NO,NA	NO,NA	NO,NA	NO,NA	NO,NA	NO,NA	NO,NA	NO,NA	NO,NA	NO,NA	NO,NA	NO,NA
Total (without LULUCF)	59,473	61,397	65,243	63,745	64,653	69,306	67,013	70,199	75,059	83,169	82,420	81,940	86,395	81,299	84,521	86,489
Total (with LULUCF)	66,611	59,166	56,376	54,053	55,826	59,115	57,955	60,103	65,351	72,965	80,374	73,599	78,480	86,229	80,134	89,979
Total (without LULUCF, with indirect)	59,552	61,473	65,325	63,826	64,785	69,475	67,169	70,383	75,235	83,345	82,586	82,116	86,569	81,491	84,717	86,676
Total (with LULUCF, with indirect)	66,689	59,242	56,458	54,133	55,958	59,283	58,111	60,286	65,527	73,142	80,540	73,774	78,654	86,421	80,330	90,165

	2006	2007	2008	2009	2010	2011	2012	2013	2014	2015	2016	2017	2018	2019	2020	2021	% change 1990-2021
	CO₂ equivalent (Gg)																
CO2 emissions without net CO2 from LULUCF	64,843	62,355	60,028	57,136	52,934	51,740	49,899	48,103	47,885	52,203	50,367	55,106	51,373	47,494	41,695	39,938	-11.8
CO2 emissions with net CO2 from LULUCF	62,068	58,119	49,890	45,919	45,347	47,844	47,733	47,029	42,070	47,612	50,294	74,227	47,187	42,319	36,283	33,064	-35.1
CH4 emissions without CH4 from LULUCF	12,296	12,086	11,830	11,656	11,442	11,331	11,062	10,801	10,661	10,438	10,370	10,423	10,389	10,432	10,235	10,273	-4.3
CH4 emissions with CH4 from LULUCF	12,462	12,157	11,854	11,820	11,737	11,486	11,316	11,111	10,692	10,551	10,744	11,765	10,461	10,510	10,353	10,522	-8.9
N2O emissions without N2O from LULUCF	3,329	3,480	3,401	3,189	3,194	2,880	2,878	2,871	2,997	2,906	2,854	2,936	2,953	3,014	2,965	2,939	-15.0
N2O emissions with N2O from LULUCF	4,000	4,146	4,053	3,883	3,925	3,574	3,604	3,617	3,665	3,601	3,603	3,946	3,570	3,612	3,553	3,543	-13.0
HFCs	1,149	1,367	1,605	1,787	1,916	2,068	2,197	2,339	2,460	2,594	2,722	2,895	3,007	3,130	3,086	3,159	100.0
PFCs	4	5	6	7	8	9	10	11	13	14	15	17	19	21	24	27	100.0
Unspecified mix of HFCs and PFCs	NO,NA	NO,NA	NO,NA	NO,NA	NO,NA	NO,NE,NA	NO,NE,NA	NO,NE,NA	NO,NE,NA	NO,NE,NA	NO,NE,NA	NO,NE,NA	NO,NE,NA	NO,NE,NA	NO,NE,NA	NO,NE,NA	0.0
SF6	29	32	31	34	36	30	31	32	27	24	24	26	25	25	24	24	100.0
NF3	NO,NA	NO,NA	NO,NA	NO,NA	NO,NA	NO,NA	NO,NA	NO,NA	NO,NA	NO,NA	NO,NA	NO,NA	NO,NA	NO,NA	NO,NA	NO,NA	0.0
Total (without LULUCF)	81,649	79,325	76,901	73,810	69,530	68,058	66,077	64,157	64,042	68,179	66,352	71,404	67,765	64,116	58,029	56,359	-5.2
Total (with LULUCF)	79,712	75,826	67,439	63,449	62,969	65,012	64,892	64,139	58,926	64,396	67,403	92,876	64,268	59,617	53,322	50,338	-24.4
Total (without LULUCF, with indirect)	81,837	79,515	77,067	73,961	69,695	68,214	66,239	64,302	64,181	68,323	66,487	71,546	67,889	64,259	58,150	56,524	-5.1
Total (with LULUCF, with indirect)	79,899	76,016	67,605	63,600	63,134	65,167	65,054	64,284	59,065	64,540	67,537	93,018	64,392	59,761	53,443	50,503	-24.3

NA- Not applicable; NE- Not estimated; NO- Not occurring



2.3 Emissions by Sector

According to the UNFCCC Reporting Guidelines, emissions estimates are grouped into five large IPCC categories: Energy, Industrial Processes and Product Uses (IPPU), Agriculture, Land Use, Land-Use Change and Forestry (LULUCF), and Waste.

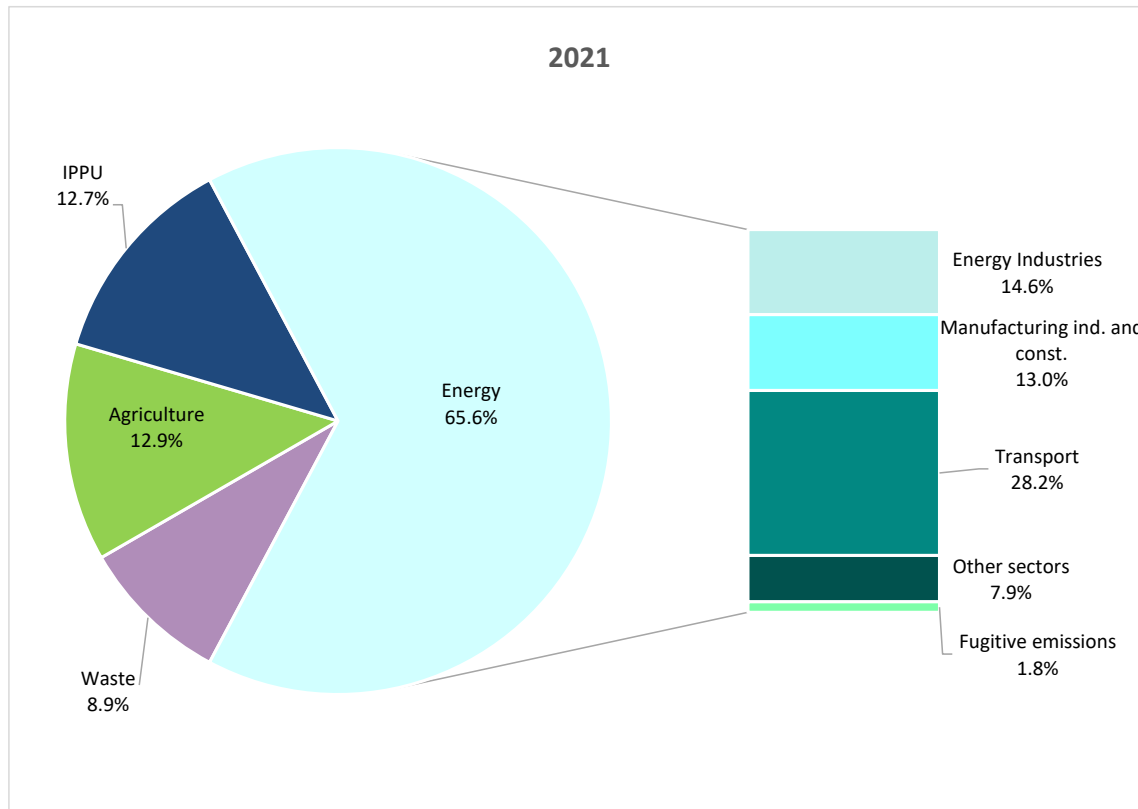

Figure 2.9 - GHG emissions in Portugal by sector (LULUCF excluded)

Energy is by far the most important sector, accounting for approximately 66 % of total emissions in 2021 and registering a decrease of 9 % over the 1990-2021 period. Energy industries and transport are the two most important sources representing, respectively, around 15 % and 28 % of total emissions.

Within the energy industries, public electricity and heat production represented 11 % of the total emissions in 2021. This sector is reducing prominence since 2017 (66 % reduction from 2017 to 2021), due to both the effect of the greater importance of renewables in electricity generation and in particular to the shift from coal to natural gas in thermal energy production. The use of coal in electricity production ended definitively at the end of 2021.

Mobile sources, which are largely dominated by road traffic, are one of the sectors that have risen faster since 1990, due to the steady growth of vehicle fleets (in particular with more powerful engines) and road travel from 1990 to the early 2000s, reflecting the increase in family income and the strong investment in the road infrastructure of the country in the 1990s and 2000-10s decades. Indirectly, the increase in road traffic activity also augments emissions from fossil fuel storage, handling and distribution. As previously mentioned, the situation stabilized in the early 2000s and started to decline in 2005. An inversion of this tendency is however registered in most recent years with an increase in transport emissions since 2013.

Still within the energy sector, the category “other sectors”, which include the residential and commercial activities, also registered a significant increase of emissions in the 1990-2004 period (74 %), but this tendency has decelerated (38 % decrease) since then, due to the implementation of energy efficiency measures.

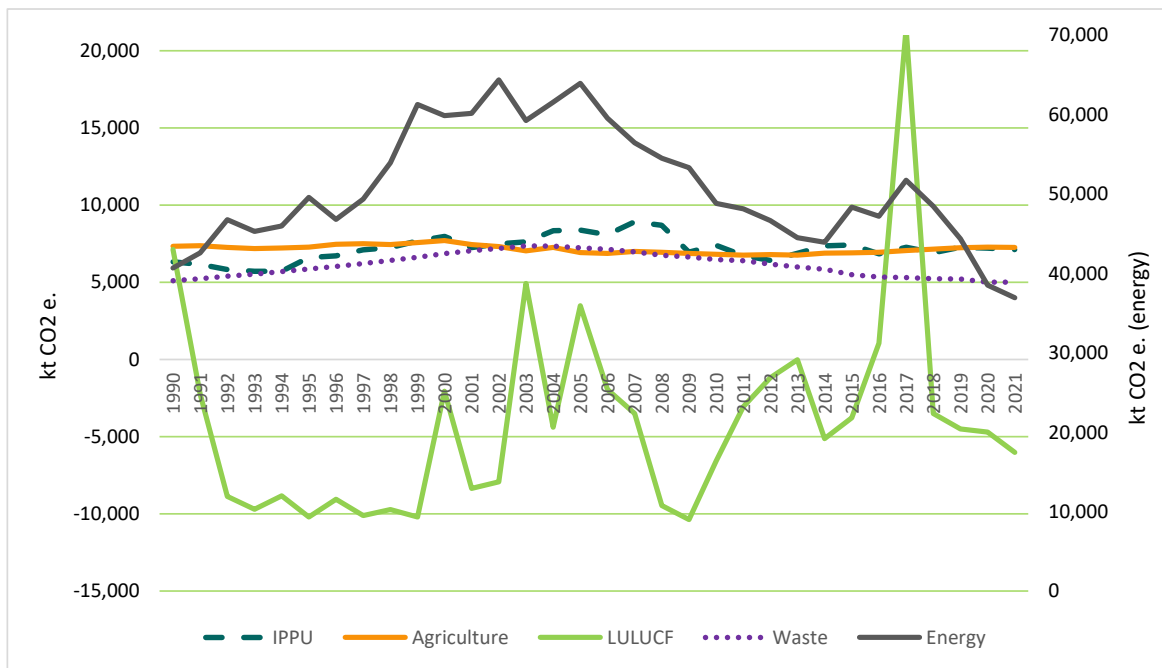

Figure 2.10: GHG emissions and removals by sector

Industrial processes represent 13 % of the Portuguese emissions in 2021 and have grown 13 % since 1990. The emissions of the sector, which are generated as by-products of many non-energy-related activities, have been driven particularly until the mid-2000s by the evolution of the mineral and chemical industry. The increase of emissions in more recent years is related to a large extent to the increase of emissions of fluorinated gases, in particular with the subsectors of stationary air conditioning and commercial refrigeration.

Agriculture was, in the period analysed, a significant source of GHG emissions, responsible for 13 % of the Portuguese emissions in 2021, corresponding to a decrease of 1 % since 1990. This fact is related to the reduction in the livestock production of certain categories of animals (sheep and swine) and more recently of dairy cattle. Furthermore, the intensification of bovine (non-dairy cattle) production and the decreased consumption of fertilizers which relates in a certain extent to the conversion of arable crops to pasture also contributes to this trend. However, since the mid-2000s, in particular after 2011, this downward trend was reversed, registering since then a growing tendency (+ 7.2% emissions variation from 2011-2021), supported mainly by a significant increase in the population of non-dairy cattle, sheep and poultry.

Waste represented approximately 9 % of Portuguese emissions in 2021 and decreased 2 % since 1990. The sector recorded, however, an expressive increase of emissions until 2004 (approximately 44 %) and presents a general downward trend since then. This increase is primarily related to the rise of waste generation (associated with the development of household income and the growth of urbanization recorded in the country during the 1990s) and the deposition of waste predominantly in landfills. The reduction in emissions in more recent years is associated to biogas recovery in waste and wastewater treatment systems, and the promotion of Mechanical and Biological Treatment, with the aim to divert urban waste from landfilling and the increase of recycling.

Estimates of emissions and sinks from land use change and forestry category show that this sector has changed from being a net emitter in 1990 (7.1 Mt CO₂ eq.) to a carbon sink in 1992. This situation was again reverted in the years 2003 and 2005 due to the severe forest wildfires events registered in these years. In 2017 this sector became again a net emitter, with a total of 21.5 Mt CO₂e., representing 23.2 % of the country's total emissions including the sector for that year.



This situation was related to the exceptional and tragic year in terms of forest wildfires, associated to an exceptional dry year, high temperatures, occurring namely outside the normal summer period (biggest wildfires took place in June and October), and unusual strong winds, as the Ophelia hurricane that swept the coast of the Iberian Peninsula in October 2017, a phenomenon that can be related to climate change. Since 2018 the sector is again estimated as a sink (-3.4 Mt CO₂e., -4.4 Mt CO₂e., -4.6 Mt CO₂e. and 6.0 Mt CO₂e. in 2018, 2019, 2020 and 2021, respectively).

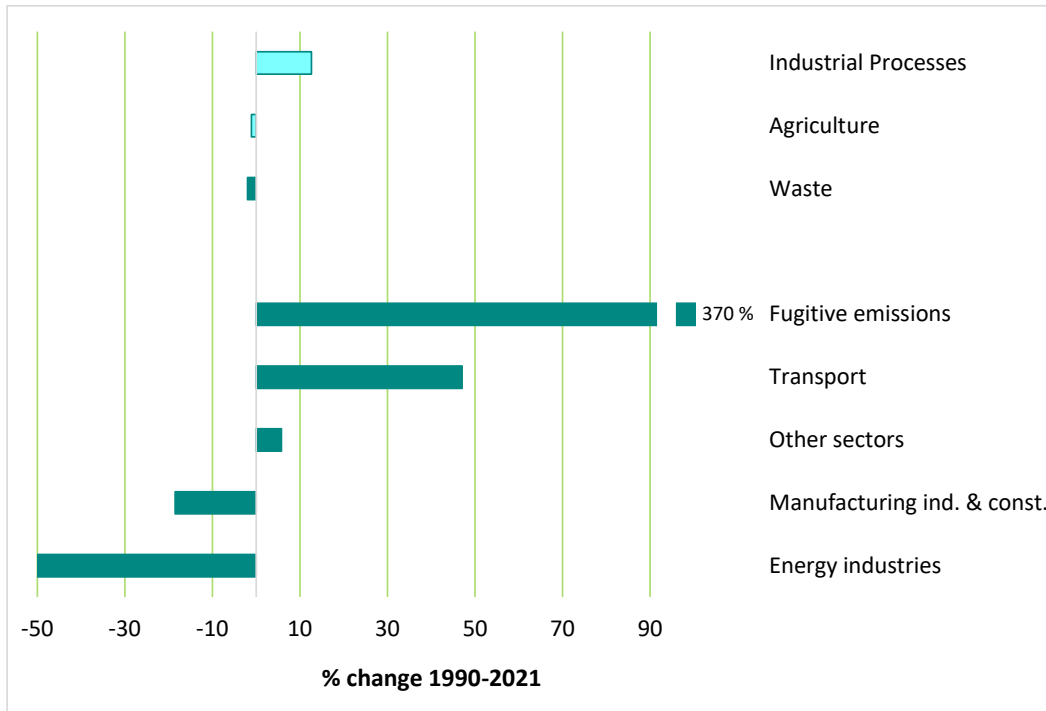

Figure 2.11: GHGs emissions percentage change (1990-2021) by IPCC category (LULUCF excluded)



Table 2.2: GHG emissions and removals by sector

GHGs SOURCE AND SINK CATEGORIES	1990	1991	1992	1993	1994	1995	1996	1997	1998	1999	2000	2001	2002	2003	2004	2005
	CO ₂ equivalent (Gg)															
1. Energy	40,692	42,622	46,775	45,308	46,004	49,571	46,806	49,378	53,932	61,278	59,880	60,191	64,370	59,264	61,575	63,955
2. Industrial processes and product use	6,332	6,166	5,819	5,709	5,723	6,602	6,712	7,109	7,249	7,683	7,972	7,253	7,501	7,625	8,341	8,378
3. Agriculture	7,339	7,369	7,253	7,196	7,222	7,278	7,467	7,494	7,454	7,584	7,699	7,449	7,326	7,048	7,254	6,929
4. Land use, land-use change and forestry(5)	7,138	-2,231	-8,867	-9,693	-8,826	-10,191	-9,058	-10,097	-9,708	-10,203	-2,046	-8,341	-7,915	4,930	-4,387	3,489
5. Waste	5,110	5,241	5,396	5,532	5,703	5,856	6,028	6,219	6,423	6,623	6,870	7,046	7,198	7,363	7,351	7,226
6. Other	NO	NO	NO	NO	NO	NO	NO	NO	NO	NO	NO	NO	NO	NO	NO	NO

GHGs SOURCE AND SINK CATEGORIES	2006	2007	2008	2009	2010	2011	2012	2013	2014	2015	2016	2017	2018	2019	2020	2021	% change
	CO ₂ equivalent (Gg)																
1. Energy	59,554	56,451	54,512	53,337	48,845	48,152	46,679	44,528	43,944	48,365	47,201	51,760	48,465	44,373	38,530	36,961	-9.2
2. Industrial processes and product use	8,083	8,913	8,695	6,959	7,392	6,732	6,423	6,885	7,362	7,412	6,849	7,273	6,914	7,271	7,213	7,132	12.6
3. Agriculture	6,879	6,995	6,944	6,881	6,814	6,769	6,794	6,757	6,890	6,911	6,954	7,068	7,149	7,249	7,272	7,258	-1.1
4. Land use, land-use change and forestry(5)	-1,937	-3,499	-9,462	-10,361	-6,561	-3,046	-1,185	-18	-5,116	-3,782	1,051	21,472	-3,497	-4,499	-4,707	-6,021	-184.4
5. Waste	7,134	6,967	6,749	6,634	6,478	6,405	6,181	5,986	5,846	5,490	5,348	5,304	5,237	5,222	5,015	5,008	-2.0
6. Other	NO	NO	NO	NO	NO	NO	NO	NO	NO	NO	NO	NO	NO	NO	NO	NO	NO

NA- Not applicable; NE - Not estimated; NO - Not occurring



2.4 Indirect GHG and SO_x emissions

Several gases do not have a direct influence in climate change but affect the formation or destruction of other GHG. CO, NO_x, and NMVOC are precursor substances for ozone which is a GHG. SO_x produce aerosols, which are extremely small particles or liquid droplets that can also affect the absorptive characteristics of the atmosphere.

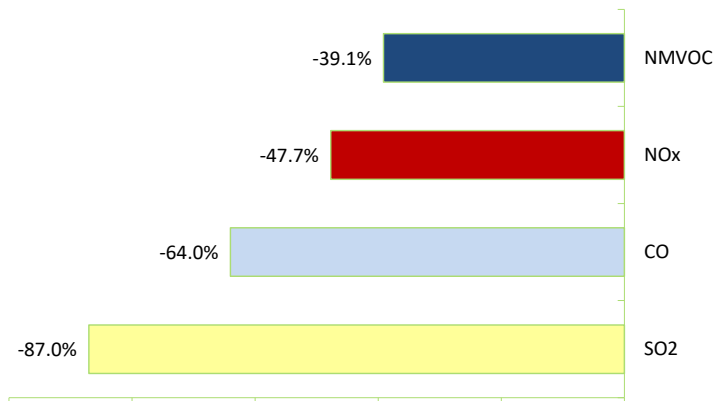

Figure 2.12: Indirect GHG and SO_x emissions: 1990-2021 variation

In 2021, emissions from all these gases have decreased compared to 1990 levels: SO_x -87.0 %, CO -64 %, NO_x -48 % and NMVOC -39 %.

Energy is the major responsible sector for emissions of NO_x, SO_x and CO. Its contribution for NMVOC emissions is also significant, together with IPPU sector.

Within energy, transportation is responsible for the largest share of NO_x emissions, approx. 46 % of 2021 totals. Despite the fast growing trends of the transport sector (mainly road) since the 90s, the introduction of new petrol-engine passenger cars with catalysts converters and stricter regulations on diesel vehicles emissions, resulted in the limitation of the growth of these emissions or even in their decrease. In fact, the situation started to shift in the mid-2000s, as transport emissions growth has first stabilized and started to decline since 2005. In the most recent years, the situation has been inversed with an increase of emissions after 2013. In the reporting period, 1990-2021, NO_x emissions from transport decreased 42.0 %; and CO and NMVOC emissions registered reductions of more than 80 %. Other sectors (commercial/institutional, residential and agriculture/forestry) is a primary source of CO emissions representing approx. 37 % of the 2021 totals.

SO_x emissions are mainly generated in the energy industry sector (approximately 33 % of total emissions in 2021) and combustion in manufacturing industries (approximately 41 % of total emissions in 2021), which are major consumers of fossil fuels. In the past, oil and coal represented the biggest share of the fuel mix used in thermal electrical production in the country. The situation shifted along the years with the significant development of renewable sources and its greater importance in electrical production, and the introduction of new stricter laws regulating the residual fuel oil (Decree-Law 281/2000, 10th November). The introduction of natural gas and its increasing use since 1997 was a major step in the control of SO_x emissions. In 2021, natural gas represented the main fuel used in electric thermal generation.

The emissions variation in the period 1990-2020 shows in fact a decrease in SO_x emissions in both sub-categories: energy industries and manufacturing industries -94 % and -79 %. Since 2007, SO_x emissions from the energy industries registered a significant reduction (approximately 89 %) which is explained by the implementation of two new abatement systems (desulfurization in two Large Point Source Energy Plants in Mainland Portugal).



The decline in emissions from electricity production in latest years is the result of the phase-down in the use of coal in thermal production, which was definitively phased-out at the end of 2021 with the closure of the last Portuguese coal thermal plant (Sines), and the greater proportion of the renewable domestic production which grew 5 % in 2021 compared to 2020, mainly due to an increase of wind power (+7 %), the use of biomass and solar energy in electricity production (respectively +6 % and + 30 %). The use of natural gas in energy production decreased by 9 % in 2021 compared to 2020.



Table 2.3: Indirect GHG and SOx emissions: 1990-2021

Gas emissions	1990	1991	1992	1993	1994	1995	1996	1997	1998	1999	2000	2001	2002	2003	2004	2005		
	CO ₂ equivalent (Gg)																	
CO	788	800	829	801	804	811	784	764	734	701	666	619	598	573	545	507		
NOx	259	273	294	284	284	296	278	280	293	305	299	296	302	278	280	282		
NMVOG	249	251	255	242	241	235	236	237	238	236	232	221	216	205	197	186		
SO2	318	308	367	310	288	322	263	275	322	331	295	277	277	185	188	189		

Gas emissions	2006	2007	2008	2009	2010	2011	2012	2013	2014	2015	2016	2017	2018	2019	2020	2021	% change
	CO ₂ equivalent (Gg)																1990-2021
CO	474	447	409	386	377	351	336	318	302	307	293	292	274	282	253	284	-64.0
NOx	260	250	232	219	203	185	172	168	165	167	160	162	157	152	134	135	-47.7
NMVOG	179	173	164	150	151	143	137	136	142	142	139	140	141	140	150	151	-39.1
SO2	165	157	104	72	62	57	52	48	43	45	45	46	45	44	38	41	-87.0

3 Energy (CRF Sector 1)

Table of Contents

3	Energy (CRF Sector 1)	3-1
3.1	Overview of the sector	3-9
3.1.1	Fuel Combustion Activities (CRF 1.A)	3-12
3.1.2	Fugitive Emissions from Fuels (CRF 1.B)	3-13
3.2	International Bunker Fuels	3-14
3.2.1	International aviation bunkers	3-14
3.2.2	International marine bunkers	3-15
3.3	Energy Industries (CRF 1.A.1)	3-16
3.3.1	Public Electricity and Heat Production (CRF 1.A.1.a)	3-16
3.3.2	Petroleum Refining (CRF 1.A.1.b)	3-29
3.3.3	Manufacture of solid fuels and other energy industries (CRF 1.A.1.c)	3-33
3.4	Manufacturing Industries and Construction (CRF 1.A.2)	3-38
3.4.1	Methodology	3-42
3.4.2	Activity data	3-45
3.4.3	Emission Factors	3-62
3.4.4	Uncertainty Assessment	3-67
3.4.5	Category-specific QA/QC and verification	3-67
3.4.6	Recalculations	3-67
3.4.7	Further Improvements	3-68
3.5	Transport (CRF 1.A.3)	3-69
3.5.1	Civil Aviation (CRF 1.A.3.a)	3-69
3.5.2	Road Transportation (CRF 1.A.3.b)	3-79
3.5.3	Railways (CRF 1.A.3.c)	3-91
3.5.4	Water-Borne Navigation (CRF 1.A.3.d)	3-94
3.5.5	Other Mobile Sources (CRF 1.A.3.e)	3-100



3.6	Other Sectors (CRF 1.A.4)	3-101
3.6.1	Category description.....	3-101
3.6.2	Methodology	3-103
3.6.3	Activity Data.....	3-105
3.6.4	Emission Factors	3-112
3.6.5	Uncertainty Assessment	3-114
3.6.6	Category-specific QA/QC and Verification.....	3-114
3.6.7	Recalculations.....	3-118
3.6.8	Further Improvements.....	3-118
3.7	Other (Not Else-where specified) (CRF 1.A.5)	3-119
3.7.1	Military Aviation (CRF 1.A.5.b).....	3-119
3.8	Fugitive Emissions from Fossil Fuels (CRF 1.B)	3-121
3.8.1	Solid Fuels: Coal Mining and Handling (CRF 1.B.1.a)	3-121
3.8.2	Solid fuels: Solid fuel transformation (CRF 1.B.1.b).....	3-126
3.8.3	Oil and natural gas and other emissions from energy production: Oil (CRF 1.B.2.a).....	3-128
3.8.4	Oil and natural gas and other emissions from energy production: Natural Gas (CRF 1.B.2.b.) .	3-138
3.8.5	Oil and natural gas and other emissions from energy production: Venting and Flaring (CRF 1.B.2.c)	3-142
3.8.6	Other Fugitive Emissions (Geothermal Electricity Production) (CRF 1.B.2.d)	3-145
3.8.7	Other Fugitive Emissions (City Gas Production) (CRF 1.B.2.d).....	3-148
3.9	Sector-specific QA/QC and verification	3-149
3.10	Further Improvements	3-150
3.11	Reference Approach.....	3-151
3.11.1	Category description	3-151
3.11.2	Methodology	3-151
3.11.3	Actual Carbon Dioxide Emissions	3-154
3.11.4	Results - Comparison of Reference Approach and Sectoral Approach.....	3-154
3.11.5	Feedstock	3-156

List of Figures

Figure 3-1: Energy emissions from the total greenhouse gas emissions in 2021	3-9
Figure 3-2: Total CO ₂ e emissions from the Energy Sector (CRF 1)	3-11
Figure 3-3: Trend of total GHG emissions in source 1A, expressed as CO ₂ e, by sub-sector.....	3-12



Figure 3-4: Trend of total GHG emissions in source 1B, expressed as CO ₂ e, by sub-sector	3-13
Figure 3-5: International navigation and aviation bunkers	3-14
Figure 3-6: International aviation bunkers.....	3-15
Figure 3-7: International marine bunkers	3-15
Figure 3-8: Trends of fuel consumption per fuel type.....	3-23
Figure 3-9: Trends of fuel consumption in Azores and Madeira Archipelagos	3-24
Figure 3-10: Trends in consumption of fuels in non-public co-generation plants	3-24
Figure 3-11: Comparison of total fuel consumption in large power plants, between values used in the inventory (INERPA) and in the Energy Balance	3-26
Figure 3-12: Comparison of fuel consumption between DGEG energy balance and IEA energy statistics..	3-27
Figure 3-13: Fuel consumption in refineries.....	3-31
Figure 3-14: Net Calorific Value (NCV) expressed in MJ/kg by fuel type	3-31
Figure 3-15: Coking coal consumption and coke, coke oven gas and coal tar production in the coke plant ..	3-35
Figure 3-16: Consumption of fuels in co-generation in city gas production	3-36
Figure 3-17: GHG's emissions from 1990 to 2020 for Manufacturing Industries and constructions subcategories	3-41
Figure 3-18: Final energy consumption for Diesel and Biodiesel	3-44
Figure 3-19: Distribution of Large Point Sources in Portugal mainland	3-46
Figure 3-20: General procedure for emissions estimate.....	3-47
Figure 3-21: Total Energy Consumption in Manufacturing Industries and Construction	3-50
Figure 3-22: Share of energy consumption by source & Greenhouse gases emissions intensity.....	3-51
Figure 3-23: Share of energy consumption by source & Greenhouse gases emissions intensity.....	3-52
Figure 3-24: Share of energy consumption by source & Greenhouse gases emissions intensity.....	3-53
Figure 3-25: Share of energy consumption by source & Greenhouse gases emissions intensity.....	3-54
Figure 3-26: Share of energy consumption by source & Greenhouse gases emissions intensity.....	3-55
Figure 3-27 Energy consumption for the 4 main sub-sectors of category 1.A.2.f broken down by fuel type.	3-56
Figure 3-28: Share of energy consumption by source & Greenhouse gases emissions intensity.....	3-57
Figure 3-29: Comparison of total LPS consumption in Paper Pulp units with the reported consumption in the EB for the sector "Paper pulp and paper production"	3-58
Figure 3-30: Comparison of total LPS consumption in Petrochemical units with the reported consumption in the EB for the sector "Chemical and Plastics"	3-59
Figure 3-31: Comparison of total LPS consumption in Cement Plant with the reported consumption in the EB for the sector "Cement and Lime" (Due to confidentiality issue y axis values are not shown).....	3-60
Figure 3-32: Total paper pulp production: Kraft and sulphide paper pulp	3-61



Figure 3-33: Ceramic Production according to type of ceramic.....	3-62
Figure 3-34: Glass production by glass type (excluding flat glass production)	3-62
Figure 3-35: Decision tree for emissions from aviation (EMEP/EEA, 2019)	3-70
Figure 3-36: Decision tree for LTOCycle emission calculation.....	3-72
Figure 3-37: Decision tree for distinction between domestic and international emissions.	3-77
Figure 3-38: Total Fuel consumption of aviation gasoline and jet fuel (Source: DGEG).	3-77
Figure 3-39: Fuel and lubricant consumption from Road Transportation sector (TJ).	3-82
Figure 3-40: Number of Passenger Cars by fuel type.	3-87
Figure 3-41: Kilometers travelled by vehicle type (vkm).	3-88
Figure 3-42: Consumption of fuels in the railway transport sector.	3-92
Figure 3-43: Generic methodology flowchart.	3-95
Figure 3-44: Ship fleet.	3-97
Figure 3-45: Split in Thermal Uses for Commercial/Institutional Sector.....	3-105
Figure 3-46: Split in Thermal Uses for Residential Sector	3-106
Figure 3-47: Split in appliances/technologies for Residential Sector – Wood Burning.....	3-106
Figure 3-48: Split in Thermal Uses for Agriculture Sector - Diesel	3-107
Figure 3-49: Energy consumption in Comercial/Institutional sector - by Fuel, Source and Final Use	3-108
Figure 3-50: Energy consumption in Residential sector - by Fuel, Source and Final Use.....	3-109
Figure 3-51: Energy consumption in Agriculture sector - by Fuel, Source and Final Use.....	3-110
Figure 3-52: Energy consumption in fishing sector - by Fuel, Source and Final Use.....	3-111
Figure 3-53: Energy consumption comparison between Inventory, National Energy Balance and EUROSTAT data by sector	3-115
Figure 3-54: Energy consumption comparison between National Energy Balance and Inventory data by fuel type.....	3-117
Figure 3-55: Energy Consumption in Military aviation.....	3-119
Figure 3-56: Amount of coal extracted from mines in Portugal.....	3-124
Figure 3-57: Coke production in the coke plant	3-126
Figure 3-58: Total amount of crude arriving in Marine Terminals	3-129
Figure 3-59: Coke burned in the Fluid Catalytic Cracking Unit.....	3-131
Figure 3-60: Coke burned in Platforming/Continuous Catalyst Regeneration (CCR)	3-133
Figure 3-61: Fuel consumption and Hydrogen production in the hydrogen steam reformers.....	3-134
Figure 3-62: Total amount of crude throughput	3-136
Figure 3-63: Fugitive Emissions from Natural Gas.....	3-138
Figure 3-64: Natural Gas transported by High, Medium and Low Pressure Networks	3-141



Figure 3-65: Total consumption of flare gas in Portuguese refineries and Low Heating Value	3-143
Figure 3-66: Total amount of crude throughput in refineries	3-144
Figure 3-67: Total Geothermal Production in Azores.....	3-146
Figure 3-68: Apparent energy consumption	3-153
Figure 3-69: Fuel consumption excluded from Apparent Consumption.....	3-154
Figure 3-70: Comparison of Energy Consumption and CO ₂ emissions between the National approach and the Reference Approach.....	3-155
Figure 3-71: Carbon dioxide (CO ₂) emissions from non-energy use by sector.....	3-156

List of Tables

Table 3-1: Total Greenhouse Gas Emissions from Energy (Mt CO ₂ e)	3-10
Table 3-2: Key categories in Energy Sector (CRF 1) and methodologies used in emission estimates	3-11
Table 3-3: Large Point Sources in the sector of Public Electricity and Heat Production	3-17
Table 3-4: Electricity Power Plants in the Azores and Madeira	3-19
Table 3-5: Emission Factors for energy production sector. Greenhouse Gases.....	3-21
Table 3-6: CO ₂ Emission Factors for energy production sector – Plant specific.....	3-21
Table 3-7: Emission Factors for thermo-electricity production in Azores and Madeira. Greenhouse Gases ..	3-22
Table 3-8: Emission Factors for non public co-generation self producers. Greenhouse Gases	3-22
Table 3-9: Low Heating Value per fuel type	3-23
Table 3-10: LHV per fuel type	3-24
Table 3-11: LHV per fuel type used for non-public co-generation plants estimates.....	3-25
Table 3-12: Greenhouse Gases' emission factors for combustion sources in Petroleum Refining	3-30
Table 3-13: Emission factors used in the carbon balance for the coke plant	3-34
Table 3-14: CH ₄ emission factor from coke production	3-34
Table 3-15: Emission Factors used for the coke plant and city gas production	3-35
Table 3-16: NCV/LHV per fuel type for city gas production	3-36
Table 3-17: Subcategories under the Manufacturing Industries and Construction category.....	3-38
Table 3-18: Key categories in Manufacturing Industries and Construction (CRF 1A2) and methodologies used in emission estimates	3-38
Table 3-19: Total Greenhouse Gas Emissions from Manufacturing Industries and Construction (Mt CO ₂ eq) 3-	39
Table 3-20: Incorporation rate of biodiesel (% toe/toe)	3-43
Table 3-21: Structure of the Portuguese Energy Balance. Sectoral categories.....	3-48



Table 3-22: Structure of the Portuguese Energy Balance. Fuel categories	3-48
Table 3-23: Definition of Sectors in accordance with Economic Activity Classes	3-49
Table 3-24: Total Paper Pulp Production (Kraft and sulphide paper pulp)	3-61
Table 3-25: Ceramic Production according to type of ceramic (kt).....	3-61
Table 3-26: Glass production by glass type (kt/yr) excluding flat glass production.....	3-62
Table 3-27: Default emission factors of Greenhouse gases for combustion equipments in Manufacturing Industry.....	3-63
Table 3-28: Emission factors of Greenhouse gases in the extractive industry.....	3-64
Table 3-29: Emission factors for Greenhouse gases in the building and construction industry	3-64
Table 3-30: Emission factors for use in LPS units in the iron and steel sector	3-64
Table 3-31: Emission factors for use in LPS units in the Chemical Industry: Greenhouse Gases from combustion	3-65
Table 3-32: Emission factors used in LPS units in the Paper Pulp Industry: Greenhouse Gases from combustion – Energy Approach	3-65
Table 3-33: Emission factors used in LPS units in the Paper Pulp Industry: Greenhouse Gases from combustion – Production Approach.....	3-66
Table 3-34: Greenhouse Gases Emission Factors for ceramic production using the Production Approach: Greenhouse gases	3-66
Table 3-35: Emission Factors for glass production using the Production Approach: SO _x and Indirect Precursor gases (kg/t glass).....	3-66
Table 3-36: Emission Factors for glass production using the Production Approach: Greenhouse Gases....	3-66
Table 3-37: Greenhouse Gases Emission Factors for Cement Industry using the Energy Approach	3-66
Table 3-38: Greenhouse Gases Emission Factors for Off-road vehicles and other machinery	3-67
Table 3-39: Recalculated data for category Manufacturing industries and construction (CRF 1.A.2)	3-68
Table 3-40: Estimated emissions from Civil Aviation (kt CO ₂ eq).	3-69
Table 3-41: IPCC 2006 source categories.	3-69
Table 3-42: Emissions factors for most common aircraft movements in national airports.....	3-73
Table 3-43: Airport based LTO emission factors (kg/movement).	3-74
Table 3-44: Cruise emissions and fuel consumption.	3-75
Table 3-45: Fuel dependent emission factors	3-76
Table 3-46: LTO _{Cycle} per airport.	3-76
Table 3-47: Aviation activity level uncertainty.	3-78
Table 3-48: Estimated emissions from Road Transportation (Kt CO ₂ eq).....	3-79
Table 3-49: Road Transportation distance based implied emission factor for 2021 (g/km and mg/km). ...	3-80
Table 3-50: Monthly average ambient temperatures (°C) and relative air humidity (%).	3-81
Table 3-51: Fuel specifications.	3-81



Table 3-52: Sulphur content in petrol and diesel (ppm wt).	3-82
Table 3-53: Reid Vapour Pressure (kPa).	3-82
Table 3-54: Incorporation rate of Biodiesel in Diesel (%).	3-83
Table 3-55: Incorporation rate of Bioethanol in Petrol (%).	3-83
Table 3-56: COPERT 5 segments.	3-84
Table 3-57: Technology classification according to first registry year.	3-85
Table 3-58: Vehicle fleet synthesis.	3-86
Table 3-59: Assumed mileage percentage driven by driving mode and vehicle type for 2021.	3-89
Table 3-60: Assumed vehicle speeds by driving mode and vehicle type.	3-89
Table 3-61: Estimated emissions from Railways (Gg CO ₂ e).	3-91
Table 3-62: Low Heating Value (LHV) – Railways.	3-91
Table 3-63: Oxidation factor and Percentage of carbon from fossil origin in fuels – Railways.	3-92
Table 3-64: Emission factors for Greenhouse gases in Railways.	3-92
Table 3-65: Incorporation rate of biodiesel (% toe/toe)	3-93
Table 3-66: Estimated emissions from Water-Borne Navigation (kt CO ₂ e).	3-94
Table 3-67: Low Heating Value (LHV) – Navigation.	3-96
Table 3-68: Carbon content – Navigation.	3-96
Table 3-69: Emission factors for Greenhouse gases – Navigation.	3-96
Table 3-70: Consumption factors.	3-96
Table 3-71: Ship docks.	3-97
Table 3-72: Total fuel sales (ton).	3-98
Table 3-73: Estimated fuel consumption (ton).	3-98
Table 3-74: Estimated fuel consumption after top-down calibration (ton).	3-98
Table 3-75: Criteria employed in the tugs fuel consumption estimation.	3-98
Table 3-76: Ship type classification for tugs fuel consumption estimation.	3-98
Table 3-77: Navigation activity level uncertainty.	3-99
Table 3-78: Subcategories considered and coverage of estimated Greenhouse gases	3-101
Table 3-79: Estimated emissions from Other Sectors (Gg CO ₂ eq.)	3-102
Table 3-80: Key categories in Other Sectors (CRF 1.A.4) and methodologies used in emission estimates	3-102
Table 3-81: Methodological approaches and main source of emissions for each sub-category	3-103
Table 3-82: Emissions factors for Category 1.A.4.a.i – Commercial/Institutional: Stationary	3-112
Table 3-83: Emissions factors for Category 1.A.4.b.i – Residential: Stationary.	3-112
Table 3-84: Emissions factors for Category 1.A.4.c.i – Agriculture / Forestry / Fishing: Stationary	3-113
Table 3-85: Emissions factors for Categories 1.A.4.a.ii, 1.A.4.b.ii and 1.A.4.c.ii – Mobile sources	3-113



Table 3-86: Emissions factors for Categories 1.A.4.c.iii – Mobile sources	3-113
Table 3-87: Emission factors.....	3-119
Table 3-88: Emission Factors for coal extraction and processing	3-123
Table 3-89: Total number of abandoned mines in each time band since 1901	3-124
Table 3-90: Percentage of abandoned underground coal mines that are gassy.....	3-124
Table 3-91: Emission Factors	3-129
Table 3-92: CO ₂ emission Factor.....	3-131
Table 3-93: CO ₂ emission factors	3-132
Table 3-94: CO ₂ emission factors.....	3-134
Table 3-95: CH ₄ emission factor for fugitive emissions in oil refining	3-135
Table 3-96: Ajustment Factor for Natural Gas Leaks.....	3-140
Table 3-97: Characteristics of natural gas	3-140
Table 3-98: Emission Factors for flaring in refineries	3-143
Table 3-99: Emission Factors for Geothermal Electricity Production	3-146
Table 3-100: Carbon content of fuels and Oxidation Factor used in the Reference Approach	3-152



3 Energy (CRF Sector 1)

André Amaro

Mónica Borges

Rita Silva

Updated: March 2023

3.1 Overview of the sector

Energy-related activities are the major sources of Portuguese GHG emissions, accounting in 2021 for 64 % of total emissions of CO₂e excluding LULUCF and including indirect CO₂. In 2021, Energy category accounted for 36.96 Mt of Portugal's total GHG emissions, with a 9.2% (3.73 Mt) decrease in overall emissions since 1990 (refer to Table 3–1 for more details). Energy emissions are primarily related to fossil fuel combustion.

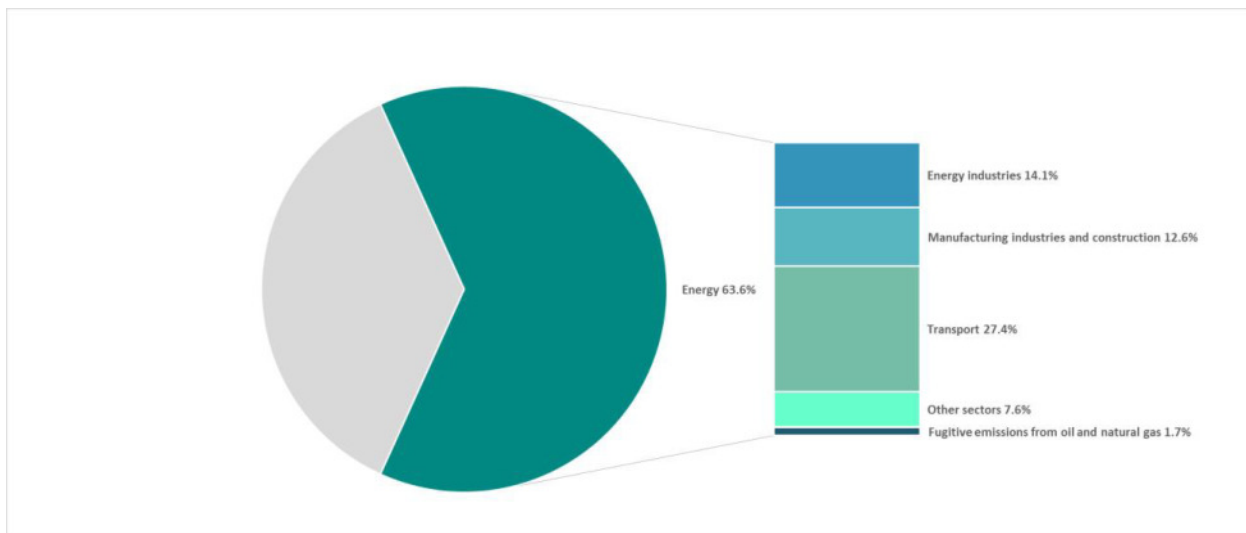

Figure 3-1: Energy emissions from the total greenhouse gas emissions in 2021

In Portugal transports and energy industries were the primary sources of Portuguese GHG emissions, representing, respectively, 27.4% and 14.1% of total GHG emissions excluding LULUCF in year 2021. It is noticeable the significant increase in emissions from transportation in comparison to the other sub-source categories.

Manufacturing industries and construction is the third largest source within the Energy sector with 12.6 % of total emissions in 2021. Other sectors which include residential, commercial/institutional, agriculture/forestry and fisheries (excluding bunkers) represents 7.6% of total sector emissions. Still with some impact on emissions in 2021, fugitive emissions from oil and natural gas arose with 1.7% of emissions. More details regarding the fugitive emissions categories in 3.1.2 Fugitive Emissions from Fuels (CRF 1.B).



Table 3-1: Total Greenhouse Gas Emissions from Energy (Mt CO₂e)

Source /Gas	1990	2005	2019	2020	2021	Δ	Δ	Δ
	kt CO ₂ e					2021-2020	2021-2005	2021-1990
						%		
1.A.1 Energy industries								
CO ₂	16 365.6	25 345.9	12 865.9	10 250.5	8 092.4	-21.1	-68.1	-50.6
CH ₄	6.7	17.8	15.9	14.7	14.5	-1.8	-18.8	116.7
N ₂ O	43.2	144.4	120.2	110.0	99.0	-10.0	-31.4	129.4
1.A.2 Manufacturing industries and construction								
CO ₂	8 854.5	10 406.7	7 676.6	7 465.5	7 165.5	-4.0	-31.1	-19.1
CH ₄	36.0	53.8	57.0	54.5	58.8	7.8	9.3	63.4
N ₂ O	111.9	152.5	99.9	100.9	111.0	10.0	-27.2	-0.9
1.A.3 Transport								
CO ₂	10 618.1	19 694.6	17 560.9	14 678.6	15 747.4	7.3	-20.0	48.3
CH ₄	110.9	68.8	25.1	20.0	21.5	7.2	-68.8	-80.6
N ₂ O	91.1	183.9	154.8	132.8	145.6	9.6	-20.9	59.8
1.A.4 Other sectors								
CO ₂	3 463.3	6 716.6	4 137.6	4 151.5	4 015.7	-3.3	-40.2	15.9
CH ₄	482.6	296.8	240.1	243.6	241.3	-1.0	-18.7	-50.0
N ₂ O	192.8	168.2	143.2	148.1	149.9	1.2	-10.9	-22.3
1.A.5 Other								
CO ₂	96.1	73.3	60.6	66.3	72.9	9.9	-0.5	-24.1
CH ₄	0.0	0.0	0.0	0.0	0.0	9.9	-0.5	-24.1
N ₂ O	0.7	0.5	0.4	0.5	0.5	9.9	-0.5	-24.1
1.B.1 Fugitive emissions from solid fuels								
CO ₂	2.9	0.0	0.0	0.0	0.0	n.a	n.a	-100.0
CH ₄	156.9	22.3	17.4	17.2	17.0	-1.2	-23.7	-89.2
N ₂ O	0.0	0.0	0.0	0.0	0.0	n.a	n.a	n.a
1.B.2 Fugitive emissions from oil and natural gas								
CO ₂	53.7	563.2	1 133.2	1 012.8	944.8	-6.7	67.8	1659.1
CH ₄	2.4	43.3	62.2	59.7	61.6	3.2	42.4	2427.4
N ₂ O	2.1	2.6	2.2	2.2	1.9	-11.6	-26.9	-8.6
Total								
CO ₂	39 454.3	62 800.3	43 434.8	37 625.2	36 038.7	-4.2	-42.6	-8.7
CH ₄	795.4	502.8	417.7	409.8	414.6	1.2	-17.5	-47.9
N ₂ O	441.8	652.2	520.8	494.5	507.8	2.7	-22.1	14.9
Total All gases	40 691.6	63 955.3	44 373.3	38 529.5	36 961.2	-4.1	-42.2	-9.2

Total emissions from this sector have decrease 9.2% from base year to last year. The year with maximum emissions occurred in 2002, as may be seen in Figure 3.2. The oscillations in CO₂e emission for the energy sector are mainly due to inter-annual variation in availability of hydropower. In recent years there has been a decreasing trend in emission resulting not only from a period of economic stagnation in Portugal but also with the implementation of measures that had a positive impact in the reduction of emissions, such as the introduction of lower carbon intensive fuels, the installation of combined cycle thermoelectric plants and co-generation units, and the use of renewable energy sources.

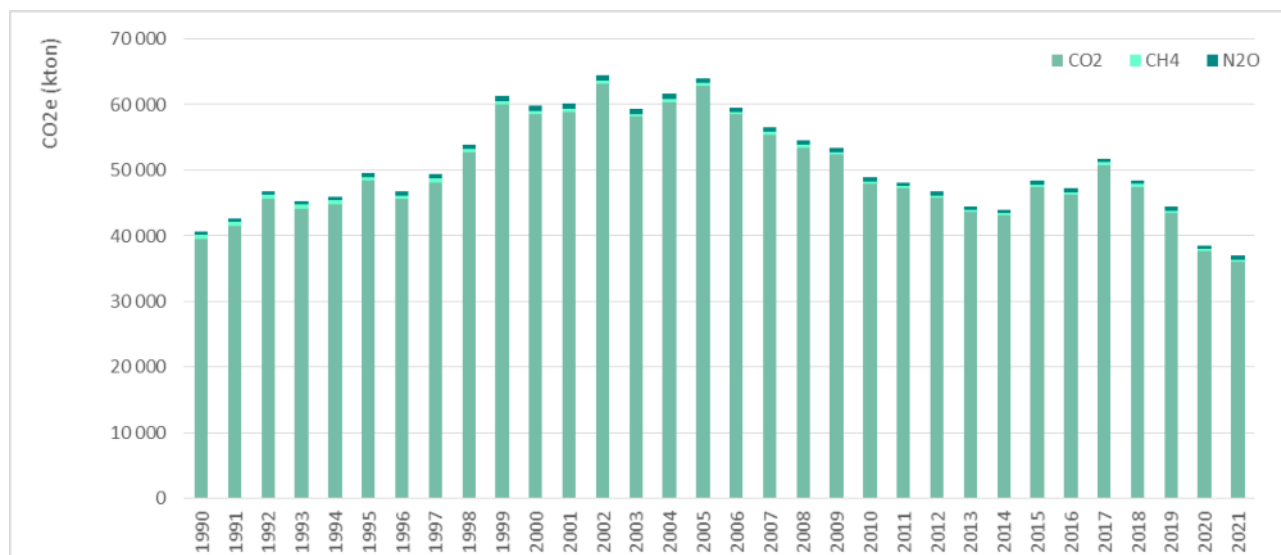

Figure 3-2: Total CO2e emissions from the Energy Sector (CRF 1)

Fifteen key categories have been identified for this sector in 2021, for level and trend assessment, using both the IPCC Approach 1 and Approach 2:

Table 3-2: Key categories in Energy Sector (CRF 1) and methodologies used in emission estimates

IPCC category	Gas	Criteria	Method
1.A.3.b Road Transportation	CO2	L,T	T1
1.A.1 Energy industries - Gaseous fuels	CO2	L,T	T2, T3
1.A.2 Manufacturing industries and construction - Gaseous fuels	CO2	L,T	T2, T3
1.A.2 Manufacturing industries and construction - Liquid fuels	CO2	L,T	T1
1.A.4 Combustion Other Sectors - Liquid fuels	CO2	L	T1
1.A.1 Energy industries - Solid fuels	CO2	L,T	T3
1.A.1 Energy industries - Liquid fuels	CO2	L,T	T1
1.A.4 Combustion Other Sectors - Gaseous fuels	CO2	L,T	T2
1.B.2.a Fugitive emissions - Oil	CO2	L,T	T2, T3
1.A.1 Energy industries - Other fossil fuels	CO2	L,T	T1, T3
1.A.2 Manufacturing industries and construction - Other fossil fuels	CO2	L,T	T1, T3
1.A.3.a Civil (domestic) aviation	CO2	L	T1, T3
1.A.4 Combustion Other Sectors - Biomass	CH4	L	T1, T2
1.B.2.b Fugitive emissions – Natural Gas	CH4	T	T2
1.A.2 Manufacturing industries and construction - Solid fuels	CO2	L,T	T2, T3
1.B.1.Fugitive emissions – Solid Fuels	CH4	T	T1



3.1.1 Fuel Combustion Activities (CRF 1.A)

Energy emissions are primarily related to fossil fuel combustion. In Portugal transports and energy industries were the primary sources of Portuguese GHG emissions, representing, respectively, 27.4% and 14.1% of total GHG emissions excluding LULUCF in year 2021. It is noticeable the significant increase in emissions from transportation in comparison to the other sub-source categories. Manufacturing industries and construction is the third larger source within Fuel Combustion Activities with 12.6% of total emissions in 2021. Other sectors which include residential, commercial/institutional, agriculture/forestry and fisheries (excluding bunkers) represents 7.6% of total sector emissions. Emissions for the full time trend in Figure 3.4. The emissions from the incineration of municipal solid wastes (MSW) that occurs with energy recovery are accounted in this sector as recommended by the IPCC GPG.

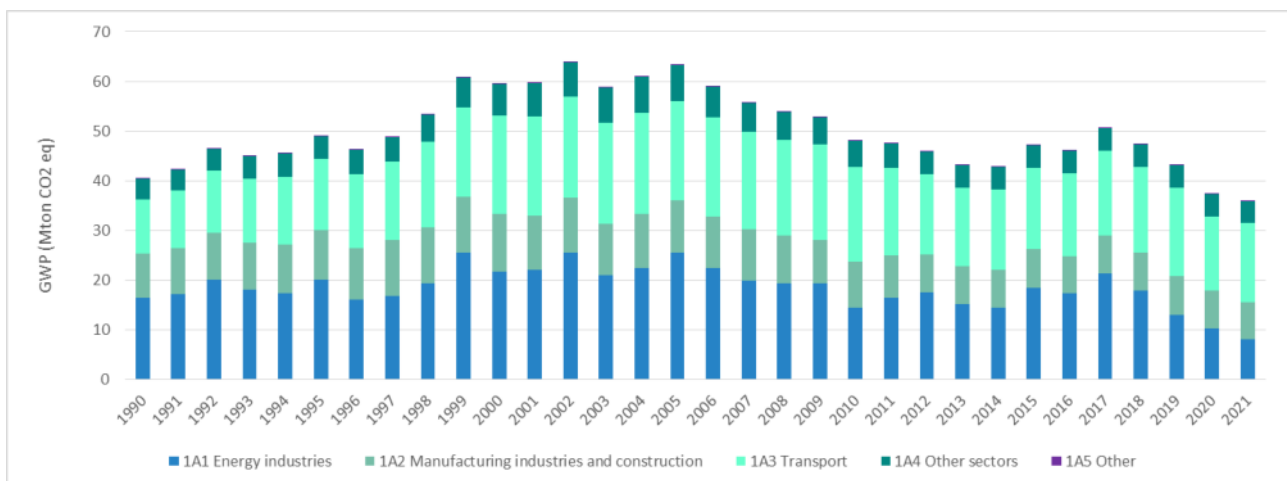

Figure 3-3: Trend of total GHG emissions in source 1A, expressed as CO₂e, by sub-sector.

GHG emissions from this activity sector are almost fully dominated by direct CO₂ emissions, which represent about 97.7 % of GHG emissions in 2020. CH₄ and N₂O are minor sources, respectively 0.9 % and 1.4 % of total GHG emissions from the 1.A sector in 2021.

CO₂ emissions are dependent on the carbon content of the fuel used and, for this reason, estimates of CO₂ emissions are more accurate and methodology simpler to apply using fuel consumption data only. During the combustion process some carbon is released in smaller amounts in the form of other gases, including CH₄, CO, NMVOC and airborne particulate matter. It is presumed that all these other carbon containing non-CO₂ gases oxidise to CO₂ in the atmosphere and are include in carbon dioxide estimates (ultimate CO₂)¹.

Emissions from fossil fuel combustion include also other atmospheric contaminants such as N₂O, NO_x, SO_x; NH₃, particulate matter, heavy metals and toxic organic compounds. Unlike CO₂, emissions estimates of these air contaminants require more detailed information, such as operating conditions, combustion and emission control technologies and fuel characteristics.

Fossil fuel combustion from international bunkers, i.e., international aviation and maritime transportation, also generates air emissions in a similar way to other fuel combustion activity. In accordance with international guidelines, these emissions are not included in national totals, but are reported separately as a memo item.

¹ Three CO₂ quantities may be referred in the inventory with different definitions: (1) End of pipe CO₂ - Carbon dioxide effectively emitted from the source: exhaust, chimney, etc; (2) Ultimate CO₂ - carbon dioxide increase contribution to atmosphere. Includes end of pipe CO₂ but also the conversion of other gases and particles that are emitted to atmosphere containing carbon and that are supposedly latter converted in CO₂; (3) Fossil ultimate CO₂ - CO₂ emissions resulting from carbon with fossil origin: fossil fuels, mineral rocks and all other non biomass carbon.



Biomass combustion also generates gas emissions. Carbon dioxide emissions from this source are estimated in the inventory but not included in national emissions totals being considered that there are no net emissions of CO₂, as carbon released during biomass combustion had been in fact fixed from atmosphere by the photosynthetic process and when is burnt and returns to atmosphere does not increase the atmospheric/biosphere CO₂ pool. This activity is reported separately for information purposes only. Nevertheless, non-CO₂ emissions from combustion of biofuels and other biomass fuels are considered in inventory totals.

3.1.2 Fugitive Emissions from Fuels (CRF 1.B)

Apart from fuel combustion emissions, the Energy sector includes also other from production, transmission, storage and distribution of fossil fuels. Generated gases from these sources are CO₂, NMVOC, SO_x, CH₄, NO_x and CO, and emissions per sub-sector source are presented in the figure below, where the major importance of emissions due to oil refining, transport and distribution for the beginning of the period may be seen, while the importance of emissions from storage and transportation of natural gas, became more relevant in recent years.

GHG emissions occurring as CO₂ are responsible for 92.1 % of 1.B total emissions in 2021. Emissions occurring as CH₄ represent 7.7 % of 1.B total emissions and N₂O represent only 0.2 %.

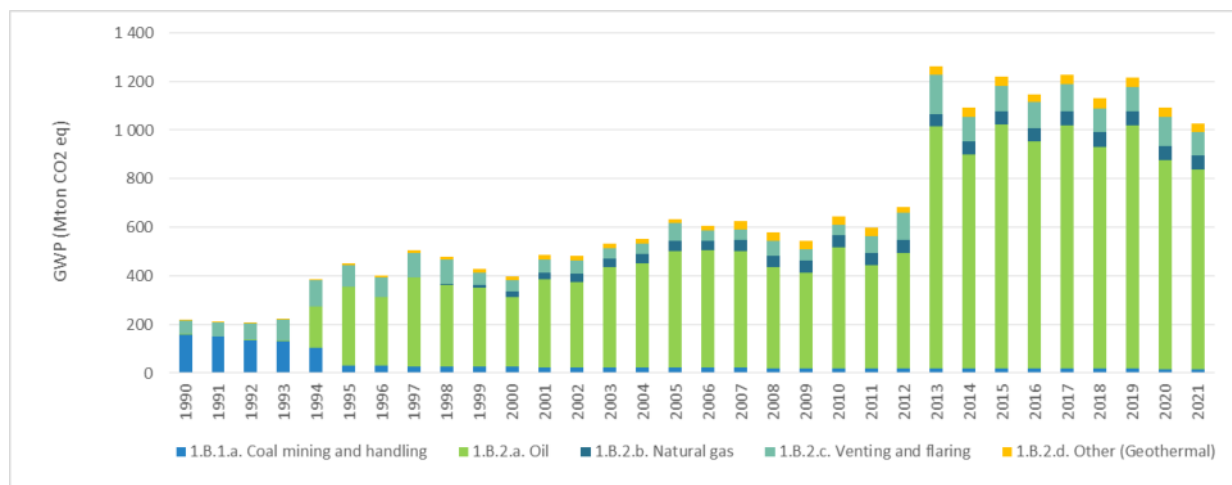

Figure 3-4: Trend of total GHG emissions in source 1B, expressed as CO₂e, by sub-sector



3.2 International Bunker Fuels

International bunker fuels used in international aviation and international navigation are presented in the figure below.

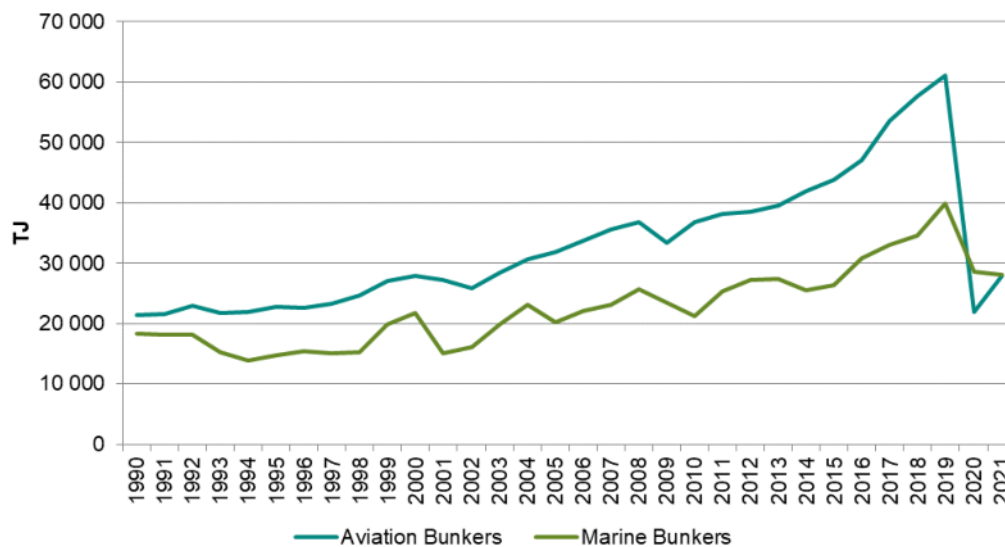

Figure 3-5: International navigation and aviation bunkers

3.2.1 International aviation bunkers

The majority of jet fuel is used for international aviation. In 2021 the quantity of jet fuel for international aviation was about 85% of total jet fuel. This percentage was estimated according with the origin and destiny of the flight as recommended by 2006 IPCC guidelines.

Until 2006, the classification for international fuel used by the national fuel authority (DGEG) was different from the one used in national inventory. DGEG split was based in the flag of the aircraft rather than in the origin and destiny of the flight. Some efforts were made in the fuel balance to use the IPCC criteria and since 2007 the difference between the reference approach (RA) and the sectoral approach (SA) has decreased. For the period between 1990 and 2006, the reference approach uses the energy consumption data from EUROSTAT.

The 1990 peak in the difference between sectoral approach and reference approach is due to a question raised during the 2016 UNFCC centralized review related with a higher consumption of jet kerosene in civil aviation. This question lead to the identification of an error in the cruise consumption compilation and the correction of the jet kerosene consumption in that year.

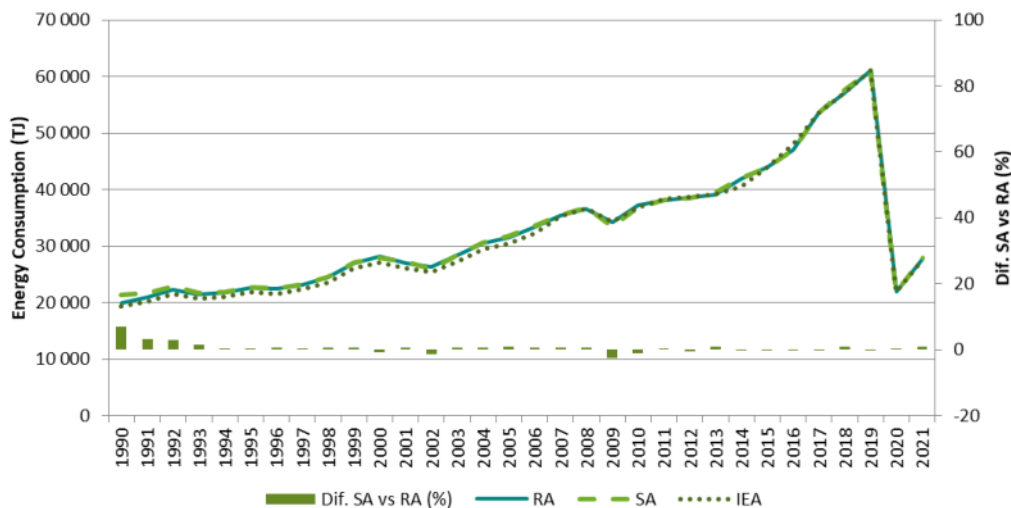

Figure 3-6: International aviation bunkers

3.2.2 International marine bunkers

In 2021 the energy consumption for international navigation was about 91% of the total energy used in marine navigation. This percentage was estimated according with the origin and destiny of the movement as recommended by 2006 IPCC guidelines.

Until 2012, the international fuel classification used by the national fuel authority (DGEG) was different from the one used in national inventory. DGEG split was based in the flag of the ship rather than in the origin and destiny of the movement. As consequence the international consumption from the reference approach (RA) differs from the consumption estimated using the sectoral approach (SA) until this date. Some efforts were made in the fuel balance to use the IPCC criteria and since 2013 the difference between the reference approach (RA) and the sectoral approach (SA) has decreased.

The international navigation energy consumption data from the IEA differ to some extent from the DGEG fuel balance. The data from IEA includes consumption from domestic navigation and this occurs because domestic consumption is missed classified as international bunkers when reported to the IEA.

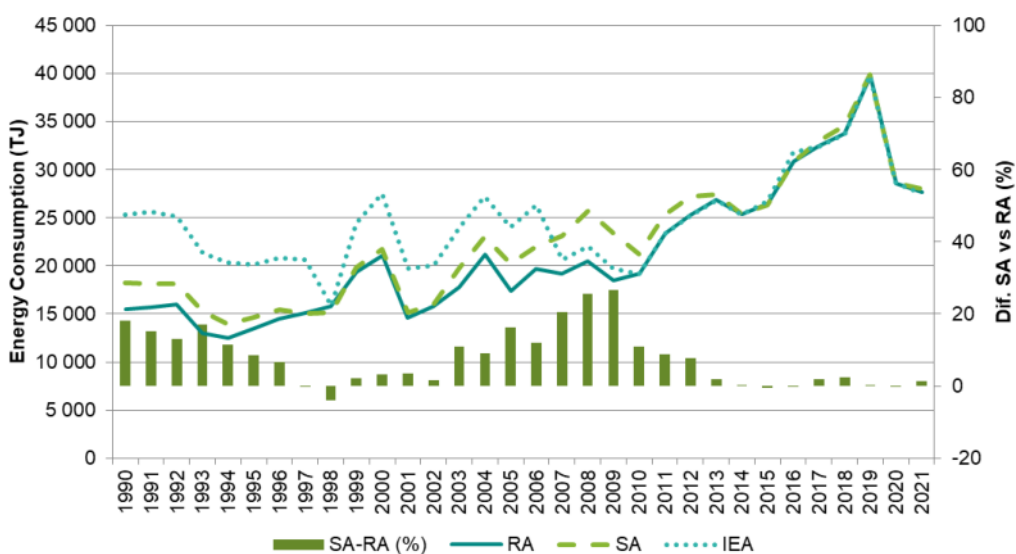

Figure 3-7: International marine bunkers



3.3 Energy Industries (CRF 1.A.1)

3.3.1 Public Electricity and Heat Production (CRF 1.A.1.a)

3.3.1.1 Category description

Until 1950 electric energy production in Portugal was based in small power plant units using coal as energy source. In the 50s increase in the demand for industry consumers induced the development of hydro-electric production units and the built of *Tapada do Outeiro* power plant using low energy coal (lignite) obtained from Portuguese mines. The next decade saw the entrance of petroleum products as the main energy sources, and three additional power plants were built: *Carregado*, *Barreiro* and *Setúbal*. After the energy crisis of 1973/74 and 1979/81 there was a political shift towards the preference for imported coal (*Sines* and *Pêgo* power plants, started in 1985 and 1993 respectively) and, more recently, towards natural gas (*Turbogás* power plant already in operation and the new TER² unit, build near the old unit in *Carregado* entered its final testing period at the end of 2003). In the islands of Azores and Madeira, the discontinuity in territory caused the prevalence of smaller units, basically one per island, working on fuel-oil or diesel-oil.

Apart from the dedicated electric power plants, auto-producers generate electric energy for own consumption and to sales to the public system. However not all combustion from these sources are included here because, according to the 2006 IPCC Guidelines, emissions from auto-producers are to be reported under the industrial or commercial branch in which their main economic activity occurs. The present source sector includes only emissions resulting from main power producers³.

Several components of the electricity and heat producing sector where arbitrarily individualized in the inventory of air emissions from the energy sector for the sake of making explanation easier and they are discussed separately in the following paragraphs.

This category includes also the emissions associated with the incineration of municipal solid wastes (MSW) with energy recovery.

3.3.1.2 Large Point Source Energy Plants in Mainland Portugal

The number of Large Point Source Energy Plants (LPS-EP) in continental Portugal has increased from 6 units in 1990 to 16 units at present. Power plants and installed power are listed in table below together with their main relevant characteristics.

² TER – Termoeléctrica do Carregado

³ Main Power Producers generate and sell electricity or heat as their main activity (primary activity) either public owned or private owned. In contrast there are other Auto-producers of electricity or heat, that also are agents producing or selling electricity or heat, but as a secondary activity and not as main business.



Table 3-3: Large Point Sources in the sector of Public Electricity and Heat Production

Power Plant	Location	Start	Situation	Fuel***	Power	Technology	Treatment of Gas Effluents****	Stack Height (m)	Comments
Tapada do Outeiro	Gondomar	1959	Deactivated (2003)	LIG + FO	150/100/47* MWe	Boiler + Steam Turbine.	ESP	60 (x3)	Lignite use stopped in 1997
Portgen (new Tapada do Outeiro)	Gondomar	1998	Working	NG + GO + LPG	990 (3x330) MWe	Combined Cycle.	DLE (only for one group)	60 (x3)	-
Soporgen	Lavos	2001	Working	NG	67 (44+23) MWe	Co-generation. Combined Cycle	DLE	50 (x2)	-
Energim	Alhandra	2002	Deactivated (2014)	NG	43.7 MWe	Co-generation. Combined Cycle	-	31 (x1)	-
Mortágua	Mortágua	1999	Working	WW + NG + GO	30 MWe	Boiler + Steam Turbine.	ESP	-	-
Pêgo	Abrantes	1993	Working	HC + FO + GO + LPG	628 MWe	Boiler + Steam Turbine.	ESP + LNOX + WFGD + SCR	225 (x1)	WFGD after 2008 SCR after 2008
Pêgo (Elecgás)	Abrantes	2010	Working	NG + GO	800 MWe	Combined Cycle	DLE	80 (x2)	
Carregado	Alenquer	1968	Deactivated (2011)	FO + NG + GO + LPG	750 (6x125) MWe	Boiler + Steam Turbine.	ESP	100 (x3)	Natural gas introduced in 1997
TER	Alenquer	2004	Working	NG + GO	1170 MWe	Combined Cycle.	-	75 (x3)	-
Carriço	Sines	2006	Working	NG + GO	487 MWe	Co-generation.	-	30 (x1)	-
Alto do Mira	Amadora	1975	Deactivated (2003)	GO	132 MWe	Gas Turbine.	-	13.5 (x1)	-
Barreiro	Barreiro	1978	Deactivated (2010)	FO + LPG	65 (32+33) MWe	Co-generation.	-	104 (x1)	-
Fisigen	Barreiro	2009	Working	NG	121 MWt	Co-generation.	-	-	-
Setúbal	Setúbal	1979	Deactivated (2013)	FO + GO + LPG	1000 (4x250) MWe	Boiler + Steam Turbine.	ESP	201 (x2)	-
Sines	Sines	1985	Working	HC + FO	1256 (4X314) MWe	Boiler + Steam Turbine.	ESP + LNOX + WFGD + SCR	225 (x2)	WFGD after 2008 SCR after 2011
Tunes	Silves	1973	Deactivated (2013)	GO	199.2 (2x16.3 + 2x83.3) MWe	Gas turbine.	-	13.5	Groups 1 and 2 deactivated in 2007.
Lares	Figueira da Foz	2009	Working	NG + GO	1428 MWt	Combined Cycle.	-	-	-
Constância	Constância	2009	Working	WW + FO + LPG	39.2 MWt	Boiler + Steam Turbine.	-	-	-
Figueira da Foz	Figueira da Foz	2009	Working	WW + NG	31.2 MWt	Boiler + Steam Turbine.	DLE + ESP	80	-
Cacia	Cacia	2009	Working	WW + NG + GO	49.75 MWt	Boiler + Steam Turbine.	-	-	-
CB Setúbal	Setúbal	2009	Working	WW + NG + GO	49.75 MWt	Boiler + Steam Turbine.	-	-	-
Rodão	Vila Velha do Rodão	2008	Working	WW + FO + LPG + GO	39.1 MWt	Boiler + Steam Turbine.	-	-	-
Artelia	Sines	2011	Working	NG + BG	269.7 (135.9 + 33.8 + 100) MWt	Combined Cycle.	LNOX	45	-

* 250 MW in 2 groups using fuel oil and natural gas.

** The smaller power value refers to situation after 2 of the 3 initial groups where closed. The intermediate value refers to the situation when 2 groups where operating.

*** HC - hard-coal; LIG - Lignite; FO - fuel-oil; GO - Diesel oil; NG - Natural Gas; WW – Wood Waste; BG - Biogas ; LPG – Liquid Petroleum Gas

**** WFGD – Wet Flue Gas Desulfurization; DLE – Dry Low Emissions; ESP – Electrostatic Precipitators; LNOx – Low Nox Burners; SCR - Selective Catalytic Reduction



There are two small gas turbine power plants included in the public service: one near Lisbon to sustain peak power demands and another in Tunes, in the southern province of Algarve, which is used to support the increase of demand during touristry seasonal peak demands. The unit near Lisbon (Alto do Mira) has interrupted its activity in 2003.

There has also been a change in the production structure since 1990, with a reduction in the importance of the use of petroleum products (fuel-oil) and an increase in the use of imported coal - in first place - and then natural gas. The only other energy source used in these units was Orimulsion, that was used as fuel in Setúbal power plant but only in 1994 and its use had no continuation. In most recent years new power plants using wood waste were commissioned.

- In 1990 three units (Carregado, Setúbal and Barreiro) were using fuel-oil, one unit (Sines) was consuming imported hard coal and another unit (Tapada do Outeiro) was using lignite coal and fuel-oil;
- A new build coal unit (Pêgo) using hard coal, started producing electricity in 1993 and doubled its production capacity in 1995;
- The old unit in northern Portugal (Tapada do Outeiro) that was burning low heating value lignite coal, partly mined in Portugal, stopped using this fuel in 1997 but was kept producing electricity with a small consumption of fuel-oil since;
- Between 1995 and 1997 Carregado power plant shifted part of its production groups from residual fuel-oil to natural gas;
- A new unit (Portgen) consuming natural gas was build in northern Portugal near the old unit of Tapada do Outeiro and started producing in 1998;
- A new unit - TER - also using natural gas was installed, and started activity in the end of 2003, near the old unit of Carregado;
- The Mortágua unit in central Portugal initiated production in 1999 using a combination of natural gas and wood wastes;
- Soporgen and Energin, in central Portugal and Carriço (in the south) start production (Soporgen in 2001, Energin in 2002 and Carriço in 2006) using natural gas. They exist in close connection, respectively, with an industrial paper pulp plant, a chemical industry plant and a crude oil refinery;
- In 2009 a new power plant was built in Lavradio – Fisigen. This new plant replaced the Barreiro plant in 2010. Also in 2009 a new power plant was built in Figueira da Foz – Lares, which burn NG as fuel;
- In later years (2008 and 2009) new small power plants were built that burn wood waste;
- In 2010 a new combined cycle plant was inaugurated in Abrantes;
- Artelia new combined cycle plant began its operation in 2011.



3.3.1.2.1 Energy Plants in Azores and Madeira Autonomous Regions

Electricity production in the autonomous regions of Madeira and Azores islands depends mostly on small and medium scale power plants using imported residual fuel oil and/or diesel oil.

Table 3-4: Electricity Power Plants in the Azores and Madeira

Power Station	Location	Fuel*	Power
Porto Santo	Porto Santo	FO + GO	51.9 MWt
Vitória	Funchal	FO + GO + NG	326.4 MWt
Canical	Canical	FO + GO + LPG	144 MWt
Santa Bárbara	Faial	FO + GO	41.16 MWt
Belo Jardim	Terceira	FO + GO	158.8 MWt
Caldeirão	São Miguel	FO + GO	254.84 MWt
Pico	Pico	FO + GO	26.28 MWt
Graciosa	Graciosa	GO	4.26 MWe
São Jorge	São Jorge	GO	7.03 MWe
Flores	Flores	GO	2.31 MWe
Corvo	Corvo	GO	0.56 MWe
Santa Maria	Santa Maria	GO	5.68 MWe

* HC - hard-coal; LIG - Lignite; FO - fuel-oil; GO - Diesel oil; NG - Natural Gas; WW – Wood Waste

3.3.1.2.2 Non public co-generation Energy Producers

Auto-producers not included in their industrial and commercial branches were considered non public co-generation energy producers. These smaller private owned co-generation units started after 1993 and although working actually in close association with other industrial activities, are independent companies, in legal terms, which the main activity is defined as electric and heat production. Consequently they were included in this source sector and not in industry sector as emissions from other co-generation units are.

3.3.1.2.3 Municipal Solid Waste incineration

This issue is considered in the Waste (CRF 5) chapter in order to avoid repetition.

3.3.1.3 Methodology

3.3.1.3.1 Thermo-electricity Power Plants

A bottom-up sectoral Tier 2 approach was used to estimate emissions of CO₂ and other air pollutants from this activity. For carbon dioxide, a mass balance approach could be used in principle to estimate emissions from the carbon content of fuels. But because that information is not available from most power plants, the IPCC recommendation of using emission factors based on energy consumption was used: “Emission factors for CO₂ from fossil fuel combustion are expressed on a per unit energy basis because the carbon content of fuels is generally less variable when expressed on a per unit energy basis than when expressed on a per unit mass basis” (IPCC, 1996).

Total CO₂ and ultimate CO₂ emissions from fossil origin were estimated from:

$$U_{CO_2(u,f,y)} = EF_{CO_2} * Fa_{CO_2(f)} * Energy_{Cons(u,f,y)} * 10^{-3}$$

$$Fossil_{CO_2(y)} = \sum_u \sum_f [U_{CO_2(u,f,y)} * C_{Fossil(f)} * 10^{-2}]$$

**Where:**

$U_{CO_2(y)}$ – Total carbon released to atmosphere from consumption of fuel f in unit plant u, expressed in total carbon dioxide emissions (t);

$Fossil_{CO_2(y)}$ - Emissions of carbon dioxide from fossil origin (non biomass) (t);

EF_{CO_2} – Carbon content of fuel expressed in total Carbon Dioxide emissions (kg CO₂/GJ);

C_{Fossil} - Percentage of carbon from fossil origin in fuel f (%);

$Fac_{OX(f)}$ – Oxidation factor for fuel f (ratio 0..1);

$Energy_{Cons(u,f,y)}$ - Consumption of energy (Low Heating Value) from fuel f in power plant u in year y (GJ).

This formula reflects the fact that some carbon in fuel is not oxidized and not emitted to atmosphere. Although, some carbon in the fuel is not released directly as carbon dioxide but instead in the form of carbon monoxide, methane, volatile organic compounds and even in soot, ash and particulate matter as consequence of the incomplete combustion of fuel. Emissions of these compounds in airborne fraction are transformed sooner or later into CO₂ in the atmosphere or after deposition on soil. Emissions of CO₂ at stack exhaust (End-of-pipe emissions) may be estimated from final CO₂ emissions from:

$$Stack_{CO_2} = U_{CO_2} - 44/12 * (NMVOC * C_{NMVOC} + CO * 12/28 + CH_4 * 12/16 + TPM * C_{TPM}) * 10^{-3}$$

Where:

$Stack_{CO_2}$ - end of pipe emissions of carbon dioxide (kt);

NMVOC - Emissions of non-methanic Volatile Organic Compounds (t);

CO - carbon monoxide emissions (t);

CH₄ - Methane emissions (t);

TPM - Total Particulate Matter emissions (t);

C_{NMVOC} - Carbon content in NMVOC (w/w);

C_{TPM} - Carbon content of Total Particulate Matter (w/w).

Since EU-ETS data is available for inventory use plant's specific carbon content was use in those cases where fuel analysis were made by the plant operator.

For methane and nitrous oxide, emission estimates were based on the application of emission factors to energy consumption (GJ/yr). The following equation was used:

$$Emission_{(u,f,y,p)} = Energy_{Cons(u,f,y)} * EF_{(u,f,y,p)} * 10^{-6}$$

Where:

$Emission_{(u,f,y,p)}$ - Emission of pollutant p estimated from consumption of fuel f in power plant u in year y (t);

$Energy_{Cons(u,f,y)}$ - Consumption of energy (Low Heating Value/ Net Calorific Value) from fuel f in power plant u in year y (GJ);

$EF_{(u,f,y,p)}$ - Emission factor pollutant p, for fuel f consumed in power plant u in year y (g/GJ).



3.3.1.4 Emission Factors

3.3.1.4.1 Large Point Source Energy Plants

Emission factors presented in next table are only function of fuel type and they were established from available emission factors from international bibliography, while trying as much as possible to choose those that best match national circumstances:

- IPCC 2006 Revised Guidelines (IPCC,2006);
- IPCC Good Practice Guidebook (IPCC,2000);
- EMEP/ CORINAIR Emission Factor Handbook (EEA,2002; EEA, 2009);
- AP-42 (USEPA,1996; USEPA,1996b; USEPA,1998; USEPA, 1998b; USEPA,1998c);
- EU-ETS.

Table 3-5: Emission Factors for energy production sector. Greenhouse Gases

Fuel	UCO ₂ (i) kg/GJ	FacOX (i) 0..1	FossilC %	CH ₄ (i) g/GJ	N ₂ O (i) g/GJ
Lignite	101.0	1.00	100	1.0	1.5
Hard Coal	96.1	1.00	100	1.0	1.5
Fuel-oil	77.4	1.00	100	0.8	0.3
Orimulsion	77.0	1.00	100	3.0	0.6
Natural Gas	56.4 (ii)	1.00	100	1.0	1.0 – 3.0
LPG	63.1	1.00	100	1.0	0.1
Biomass	112.0	1.00	0	11.0	7.0
Diesel	74.1	1.00	100	3.0	0.6

(i) IPCC (2006); (ii) Country Specific

The following table shows the plant specific CO₂ emission factors obtained in the EU-ETS.

Table 3-6: CO₂ Emission Factors for energy production sector – Plant specific

Fuel	UCO ₂ (i) kg/GJ	FacOX (i) 0..1
Hard Coal	92.4 - 95.2	0.991 - 0.995
Fuel-oil	79.2 - 79.5	0.990 - 0.995
Natural Gas	56.1 – 57.3	0.990 - 0.995

3.3.1.4.2 Other Thermo-electricity Power Plants

The other smaller - non LPS - power plants are seldom subjected to the continuous *Autocontrolo* program and the scarce available information does not allow the establishment of plant specific emission factors. Therefore emission factors reflect an expert best guess from the available bibliography, which again is available from:

- IPCC 2006 Revised Guidelines (IPCC,2006);
- IPCC Good Practice Guidebook (IPCC,2000);
- EMEP/ CORINAIR Emission Factor Handbook (EEA,2002);
- AP-42 (USEPA,1996; USEPA,1996b; USEPA,1998; USEPA, 1998b; USEPA,1998c)



The emission factors that were used in the inventory are shown in Table 3.5 for the power plants belonging to the public system in Azores and Madeira, and in Table 3.6 for the non public co-generation self producers⁴.

Table 3-7: Emission Factors for thermo-electricity production in Azores and Madeira. Greenhouse Gases

Region	Fuel	UCO2 (i) kg/GJ	FacOX (i) 0..1	FossilC %	CH4 g/GJ	N2O (i) g/GJ
Azores	Fuel-oil	77.4	1.00	100	3.0	0.6
Azores	Diesel oil	74.1	1.00	100	3.0	0.6
Madeira	Fuel-oil	77.4	1.00	100	3.0	0.6
Madeira	Diesel oil	74.1	1.00	100	3.0	0.6
Madeira	LPG	63.1	1.00	100	1.0	0.1
Madeira	Natural Gas	56.4 (ii)	1.00	100	1.0	3.0

(i) IPCC (2006); (ii) Country Specific

Table 3-8: Emission Factors for non public co-generation self producers. Greenhouse Gases

Fuel	UCO2 (i) kg/GJ	FacOX (i) 0..1	FossilC %	CH4 g/GJ	N2O (i) g/GJ
LPG	63.1	1.00	100	1.0	0.1
Fuel –oil	77.4	1.00	100	3.0	0.6
Diesel oil	74.1	1.00	100	3.0	0.6
Natural Gas	56.4	1.00	100	1.0	1.0

(i) IPCC (2006); (ii) Country Specific

3.3.1.4.2.1 Activity Data

Activity data has different origins according to specific energy plants:

3.3.1.4.3 Large Point Source Energy Plants

Data on fuel consumption, by fuel type, for LPS are available from these sources:

- Large Combustion Plants (LCP) directive - which relies in direct information reported from the individual plant producer to the Environment Ministry;
- Self-control program (*Programa Autocontrolo*)⁵;
- Plant activity reports from EDP;
- EU-ETS – European Union Emission Trading System.

For the latest years (mainly 2009 onwards) the EU-ETS completely replaced the other sources of information. Although different information sources have been used the consistency in time series is guaranteed considering that the same original source (power plant companies) is ultimately used.

As a general rule power plant units report information about consumption in t or cubic meters of gas together with the Low Heating Value ⁶ for that specific year from where consumption of fuels in energy units are calculated from:

$$\text{Energy (GJ)} = \text{Consumption (t/year)} * \text{LHV (MJ/kg)}$$

⁴ Power producers as main activity only.

⁵ The *Auto-controlo* program is a legal obligation for major emitters.

⁶ Low Heating Value (LHV) or Net Calorific Values (NCV) measure the quantity of heat liberated by the complete combustion of a unit volume or mass of a fuel, assuming that the water resulting from combustion remains as a vapour and the heat of the vapour is not recovered (GPG). In contrast, Gross Calorific Value (GCV) or Gross Heating Value (GHV) are estimated assuming that this water vapour is completely condensed and the heat is recovered (GPG). The default in IPCC Guidelines is to use the NCV.



or:

$$\text{Energy (GJ)} = \text{Consumption (Nm}^3\text{/year)} * \text{LHV (MJ/Nm}^3\text{)}$$

When LHV/NCV was not available it was estimated from interpolation or extrapolation from the remaining available time series. The average value and range of the reported LHV per fuel type is presented in next table.

Table 3-9: Low Heating Value per fuel type

Fuel	LHV/NCV	
Lignite	16.42 (15.57 - 17.02)	MJ/kg
Hard Coal	25.62 (24.45 - 27.23)	MJ/kg
Fuel-oil	40.24 (39.42 - 41.15)	MJ/kg
Orimulsion	28.00	MJ/kg
Diesel oil	43.30	MJ/kg
Natural Gas	38.16 (36.02 - 39.16)	MJ/Nm ³
GPL	47.44 (47.28-48.55)	MJ/kg
Biomass	7.8	MJ/kg

Source: The same as for the fuel consumption (including in some cases plants specific information)

Total consumption per fuel type in comparable energy units (PJ) may be verified in the figure below.

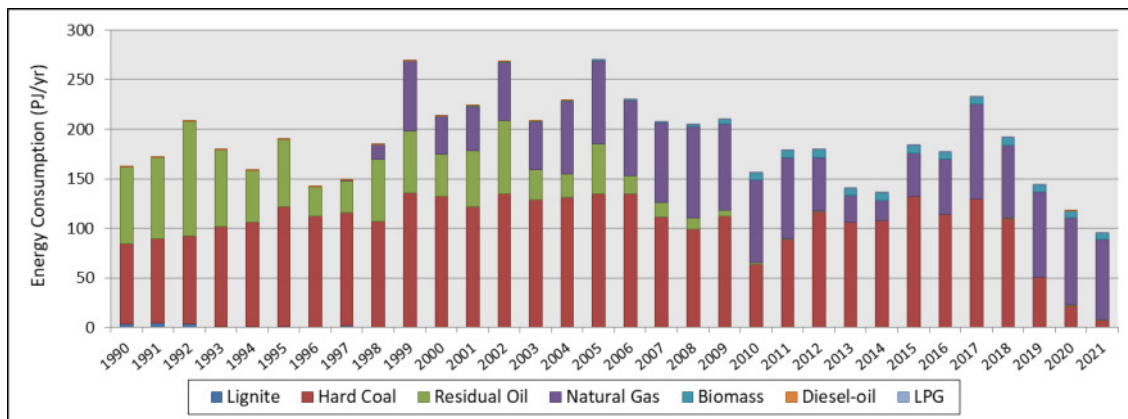

Figure 3-8: Trends of fuel consumption per fuel type

Not visible in the graph is the increase in biomass consumption (wood waste) from 1999 to 2020 (mostly in 2010 and 2011). The consumption of diesel-oil presents no clear trend since 1990 even though we can identify a slight decrease in the later years of the time series. LPG represents only a small fraction of total fuel consumption in this sector (less than 0.001 %). The relevancy of residual oil has been decreasing since 2005, representing only a fraction of total consumption in 2013 due to Barreiro power plant deactivation. In 2015 there is an increase in the consumption of Coal and Natural Gas, largely due to a dry year, reducing in this way the potential producer of hydro power plants.

3.3.1.4.4 Energy Plants in Azores and Madeira Autonomous Regions

The quantity of residual fuel-oil, diesel oil and GPL used in Madeira and Azores in electricity production is available from the following two sources:

- Madeira and Azores Regional Environmental entities;
- EU-ETS.



Full fuel consumption time series can be observed in the figure below:

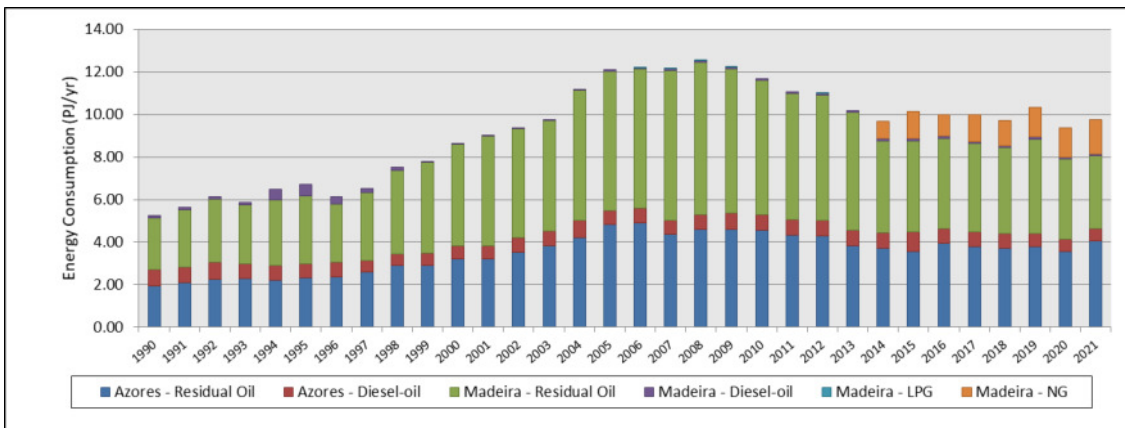

Note: Consumption of diesel oil and LPG in Madeira represent a very small quantity and is barely visible in the figure.

Figure 3-9: Trends of fuel consumption in Azores and Madeira Archipelagos

Consumption of fuels expressed in energy units was estimated from the above consumption figures assuming the Low Heating Value (LHV/NCV) values presented in the following table.

Table 3-10: LHV per fuel type

Region	Fuel type	LHV/NCV (MJ/kg)
Azores	Residual fuel oil	40.17
	Diesel oil	43.30
Madeira	Residual fuel oil	40.17
	Diesel oil	43.30
	LPG	47.28
	Natural Gas	37.9 – 38.0

Source: The same as for the fuel consumption

3.3.1.4.5 Non-public co-generation Energy Producers

Consumption of fuels in the auto-producers co-generation units (classified as energy producers) are reported in toe units in the Energy Balance (DGEG). These values can be observed in the figure below.

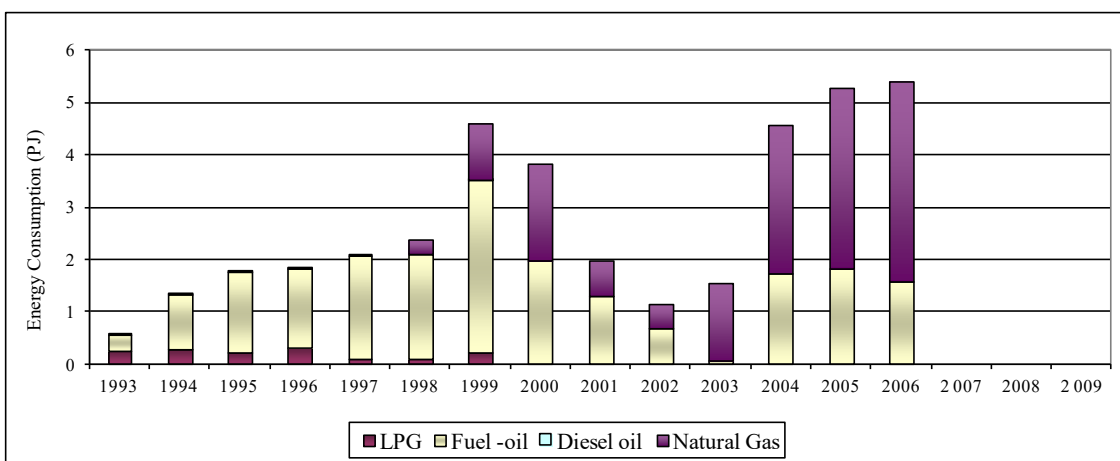

Figure 3-10: Trends in consumption of fuels in non-public co-generation plants

The figure above shows a decrease in consumption between 1999 and 2002 and then an increase in energy consumption between 2003 and 2006.



The variation occurs because the evolution of natural gas consumption in cogeneration associated with the production of electricity was strongly influenced by the separation of cogeneration units in fiscally autonomous companies for the production of electricity and heat. These companies were mainly those included in the IAIT survey (an annual survey of manufacturing industries).

The growing tendency to create different companies to manage the energy production aspect of industrial co-generation plants led to the necessity, by DGEG, to shift these units from the energy-production co-generation category back to their industrial co-generation category in the Energy Balance. As a result of this shift, from 2007 onwards the energy-production co-generation category in the Energy Balance considers only two units already included, because of their size, in the LPS estimations. Because of this and to avoid double-counting fuel consumption from 2007 onwards was made 0. Since DGEG transferred fuel consumption to the industrial co-generation category, which is used for estimating combustion emissions in the industrial sector (CRF 1A2), the emission inventory maintains its completeness.

Assumed values for LHV per fuel type are presented in next table.

Table 3-11: LHV per fuel type used for non-public co-generation plants estimates

Fuel	LHV (MJ/kg)
LPG	49.76
Fuel -oil	40.00
Diesel oil	42.60
Natural Gas	38.72 (MJ/Nm3)

Source: The same as for the fuel consumption

3.3.1.4.6 Comparison of LPS data vs. National Statistics

Consumption of fuel for electricity production in large units is also published in the Energy Balance of DGEG. Total consumption in all units was compared between the data in the inventory (INERPA) and the Energy Balance (EB) and graphs for the most important energy sources are presented in the figures below. For this analyses contacts were made with DGEG to obtain the complete list of installations covered in each energy production category of the last energy balance (small differences with previous EB are expected due to reclassification). Generally, there is an acceptable agreement between the two sources of information and, because data was acquired in an independent mode, this match gives a high degree of confidence to the results.



Lignite

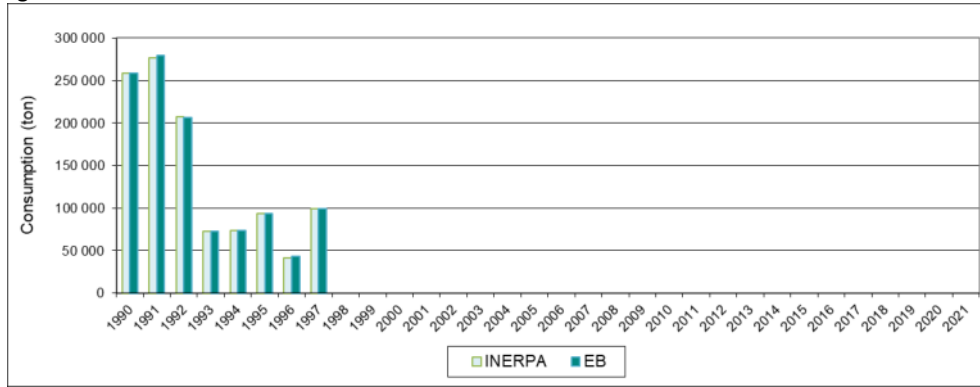

Hard Coal

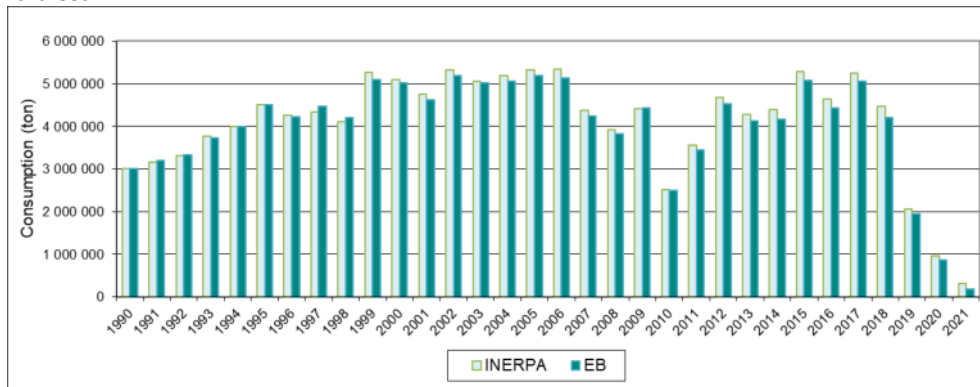

Residual Fuel Oil

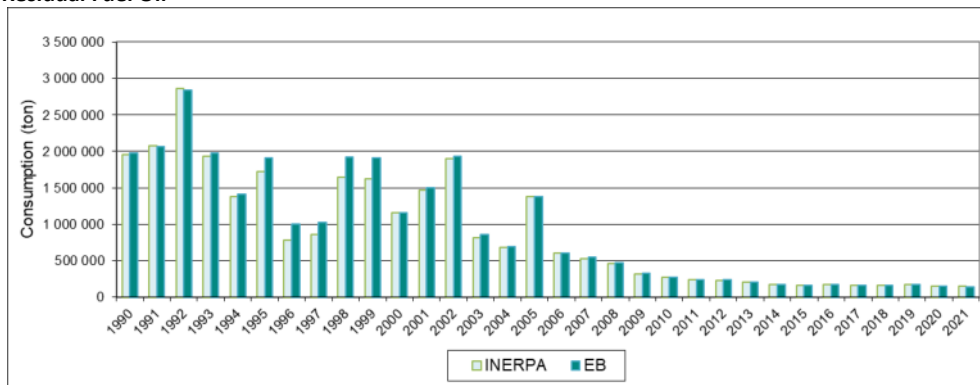

Natural Gas

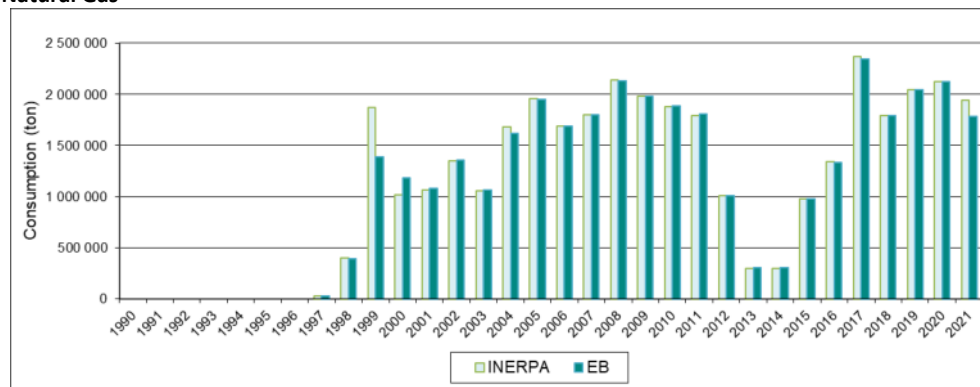

Figure 3-11: Comparison of total fuel consumption in large power plants, between values used in the inventory (INERPA) and in the Energy Balance



3.3.1.4.7 Comparison of Energy Balance vs. IEA Energy Statistics

Total energy consumption reported in DGEG energy balance was compared with IEA (International Energy Agency) energy statistics values. This comparison is included in the QA/QC procedures applied to this inventory. The energy statistic values from IEA were collect from their website. Unfortunately IEA data is only publicly available for the n-1 year (n being the latest inventory year). Following the fuel classification presented in the IEA energy statistics, three fuels types were analyzed: coal and peat, petroleum products and natural gas, connected to 8 emission sources: Electricity Plants, CHP Plants, Industry, Residential, Commercial and Public Services, Agriculture/Forestry, Fishing and Distribution Losses. The comparison between DGEG energy balance and IEA energy statistics, for 2020, is shown in the figure below.

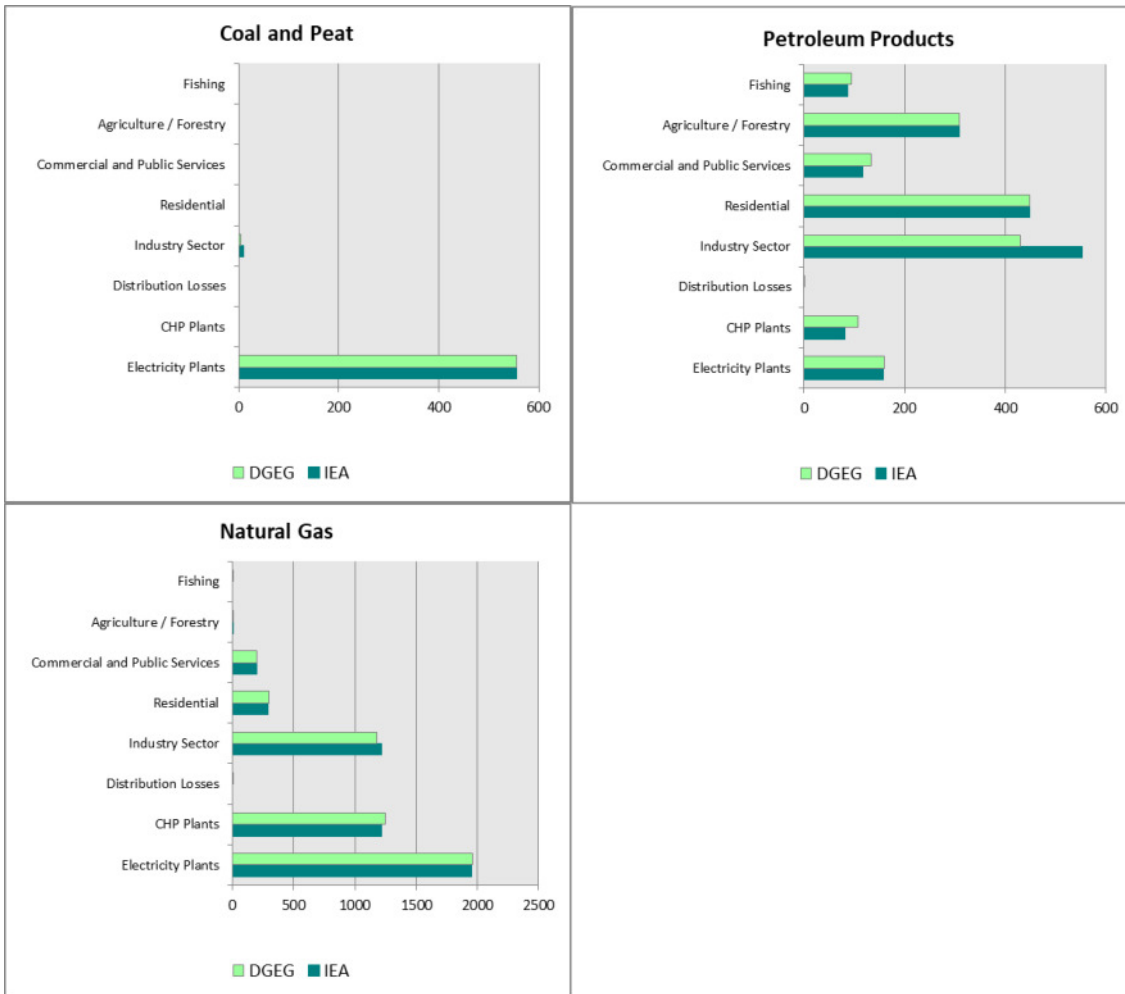

Figure 3-12: Comparison of fuel consumption between DGEG energy balance and IEA energy statistics

For natural gas and coal and peat the differences between the two data sources are very small. The consumption of petroleum products shows discrepancies for five of the eight analysed sectors: CHP Plants, Industry, Commercial and Public Services, Fishing and Distribution Losses. These differences are greater for CHP Plants and Industry which may imply a problem in the fuel consumption classification. Upon our contact DGEG explained that the differences are due to the criteria used by the IEA when counting fuel consumption for production of heat in cogeneration: IEA only counts the sold consumption, while the Energy Balance considers all the heat.



3.3.1.5 Uncertainty Assessment

The accuracy of activity data collected from direct reporting (LPS data) is expected to have a lower error than data collect in an aggregated form for the elaboration of the energy balances, in particular for those categories in the energy balance comprehending units small, multiple and dispersed. Therefore, different uncertainty values were considered in accordance with different provenience of data:

- for LPS the uncertainty value was set at 1 %, which is in the higher range of the uncertainty considered in GPG when good quality surveys are considered, which is the case; For some older information was employed the value of 2 % uncertainty;
- for area sources an uncertainty of 5 % was considered for this sector, which is fixed according to a conservative approach, considering the double of the upper range of the values that IPCC proposes when data was obtained from surveys in a less developed statistical system. This conservativeness factor is used because the surveys were made indirectly to industrial plants via fuel suppliers.

The uncertainty associated with CO₂ varies between 2 and 17 %, lower values are associated with monitoring facilities and the highest values correspond to default emission factors for fuels such as biomass. The uncertainty values in association with the other gases, methane and nitrous oxide, was also set in accordance with the GPG proposals, 150 % for CH₄ and 150 % for N₂O.

The EU-ETS defines a maximum uncertainty value of 7.5 % for the CaCO₃ consumption data reported by each plant.

Since 2009 submission, the use of plant specific data for the power plants in Azores and Madeira has decreased uncertainty.

3.3.1.6 Category-specific QA/QC and verification

QA/QC procedures were implemented primarily to check the time series consistency for fuel consumption data collect from different information sources. There were also made general checks to the emission compilation spreadsheets from which resulted several small correction to reported emission.

For large combustion plants a comparison between fuel consumption collected by the inventory team and data reported in the energy balance was made (as described in Comparison of LPS data vs. National Statistics chapter). Also a comparison between the energy balance and IEA statistics has been made to strengthen the QA/QC procedures. For this source category no major differences were found in this comparison between data sources.

3.3.1.7 Recalculations

There are no significant recalculations for category 1.A.1.a in the 2023 submission.

3.3.1.8 Further Improvements

Even though efforts were made to increase the percentage of units treated as LPS in this year inventory, the inclusion of more LPS plants is an ongoing objective for this sector as well as for industrial combustion. These efforts are in accordance with the goals that the EC⁷ has set to streamline data collection for the inventories and for the EU-ETS⁸. In the same sense on-going efforts should be maintained for the compatibilization of data acquisition by APA and DGEG in order for a better consistency of the data that is used for the Energy Balance and for the LPS data used in the inventory.

⁷ European Commission.

⁸ European CO₂ trading scheme.



3.3.2 Petroleum Refining (CRF 1.A.1.b)

3.3.2.1 Category description

In 1990 there were three oil refining plants in Portugal: Porto, Lisbon and Sines. In 1993, the Lisbon unit was closed and only two units remain in operation ever since.

Porto refinery, located in Matosinhos in northern Portugal since 1966, converts crude oil and other intermediate materials received from Sines refinery by atmospheric and vacuum distillation, cracking, platforming and several treatments processes (dissulphurization). This refinery unit has also units for the production of oils, lubricants and aromatics (benzene, hexane, toluene, xylene, etc). This facility has terminated its refining activities in April 2021.

Sines refinery, installed in 1978 in southern Portugal, has also extensive transformation of crude products after atmospheric and vacuum distillation, which are subjected to Fluid Catalytic Cracking (FCC), platforming, hydrocracking, alkylation and asphalts blowing.

The nowadays closed refinery at Lisbon performed mostly cracking. Refinery gas from this unit was used as combustible gas for domestic, service and industry use in Lisbon city.

Following the UNFCCC source categories classification, only emissions resulting from combustion in boilers and furnaces are included in this source sector. Process fugitive emissions, including combustion emissions occurred in the FCC unit are included in sub-chapter 3.8.3.5 Refining and Storage (CRF 1.B.2.a.4).

SO_x and NMVOC emissions also result from sulphur that is removed from intermediate or final products, mostly regarding environmental regulations, and conveyed in final flux gases. Elemental sulphur from the refining process is later recovered in both Sines and Porto refineries but emissions from this source are considered under sub-chapter 3.8.5 Oil and natural gas and other emissions from energy production: Venting and Flaring (CRF 1.B.2.c).

3.3.2.2 Methodology

A bottom-up sectoral Tier 2 approach was used to estimate emissions of CO₂ and other air emissions from combustion in refineries, either in boilers or process furnaces. Emissions were estimated individually for each combustion equipment when discrimination was possible.

As explained in more detail for the sector “Public Electricity and Heat Production”, total CO₂ and ultimate CO₂ emissions to atmosphere from fossil origin were estimated using the following equation set:

$$U_{CO_2} = EF_C \times Fac_{OX(f)} \times Energy_{Cons(f)} \times 44/12 \times 10^{-3}$$
$$Fossil_{CO_2} = U_{CO_2} \times C_{Fossil(f)} \times 10^{-2}$$

Where:

U_{CO_2} : Total carbon dioxide emissions (t)

EF_C : Carbon content of fuel f expressed in total carbon dioxide emissions (kg CO₂/GJ)

$Fac_{OX(f)}$: Oxidation factor for fuel f (ratio 0..1)

$Energy_{Cons(u,f)}$: Consumption of energy (Low Heating Value) from fuel f in power plant (GJ)

$Fossil_{CO_2}$: Emissions of carbon dioxide from fossil origin (non biomass) (t)

C_{Fossil} : Percentage of carbon from fossil origin in fuel f (%)

For all other pollutants the following equation was applied to estimate air emissions:



$$\text{Emission}_{(e,f,p)} = \text{Energy}_{\text{Cons}(e,f)} \times \text{EF}_{(e,f,p)} \times 10^{-6}$$

Where:

Emission_(e,f,p): Emission of pollutant p estimated from consumption of fuel f in combustion equipment e (t)

Energy_{Cons(e,f)}: Consumption of energy (Low Heating Value) from fuel f in combustion equipment e (GJ)

EF_(e,f,p): Emission factor pollutant p, for fuel f under burning conditions in combustion equipment e (g/GJ)

3.3.2.3 Emission Factors

From 2005 onwards, CO₂ emission factors were obtained directly from EU-ETS data for Porto and Sines refineries. From 1990 to 2004, due to lack of information, CO₂ emissions factors for Porto and Sines refineries were assumed equal to the first EU-ETS year (2005). Regarding Lisbon refinery (in operation until 1993), CO₂ emission factors were considered the same as Sines refinery (the nearest facility).

To estimate fugitive emissions, direct data from ETS were used. Using this information, it was possible to separate fuel consumption for combustion, from fuel used in the flares and fuel used in fluid catalytic cracking, catalyst regeneration and platforming or hydrogen production. The CO₂ EF considered in ETS is a Tier 3, and thus it is obtained directly from fuel analysis. The fuel considered in each combustion is only the fuel that is burned and not the total amount of fuel that is bought or result from a refinery process.

The same set of CH₄ and N₂O emission factors were used for all three refineries and were obtained in the 2006 IPCC Guidelines. The chosen emission factors are presented in the table below.

Table 3-12: Greenhouse Gases' emission factors for combustion sources in Petroleum Refining

Fuel	CO ₂ (1990-2004) (i)	CO ₂ from 2005 onwards (ii)	FacOX (I) 0..1	FossilC %	CH ₄ (iii) g/GJ	N ₂ O (iii) g/GJ
Fuel-oil	75.7-81.25 kg/GJ	78.34-87.99 kg/GJ	1	100	3.0	0.6
Fuel gas	38.57-65.94 kg/GJ	51.23-63.14 kg/GJ	1	100	1.0	0.1
LPG	-	63.10 kg/GJ	1	100	1.0	0.1
Diesel oil	74.13 kg/GJ	73.49-74.73 kg/GJ	1	100	3.0	0.6
Natural Gas	60.91 kg/GJ	53.8-56.80 kg/GJ	1	100	1.0	0.1
Acid Soluble Oil (ASO)	72.61 kg/GJ	63.02-72.77 kg/GJ	1	100	3.0	0.6
Off Gas	3.35-3.63 t CO ₂ /t fuel	2.38-2.80 t CO ₂ /t fuel	1	100	3.0	0.6
Tail Gas	0.21-1.12 t CO ₂ /t fuel	0.21-1.13 t CO ₂ /t fuel	1	100	3.0	0.6

(i) Source: Assumed equal to 2005 EU-ETS year; (ii) Source: EU-ETS; (iii) Source: Table 2.2, Chapter 2, Vol. 2, 2006 IPCC Guidelines

3.3.2.4 Activity Data

In 1990 there were three oil refining plants in Portugal: Porto, Lisbon and Sines. After 1993, the Lisbon unit was closed. Porto has terminated its refining activities in April 2021. Only Sines unit remains in operation.

The three refinery units consume self-produced residual fuel oil, fuel gas, liquefied petroleum gases (LPG) and gas oil.

The quantities of fuel consumption from 1990 to 2004 were collected directly from the facilities under the Large Combustion Plants (LCP) directive and may be observed in the next figure. From 2005 onwards, fuel consumption data source is EU-ETS. The use of natural gas is becoming more relevant since 2008 and the use of fuel oil (RPC) less relevant. In one of the refineries there is also consumption of Acid Soluble Oil (ASO), Off Gas and Tail Gas.

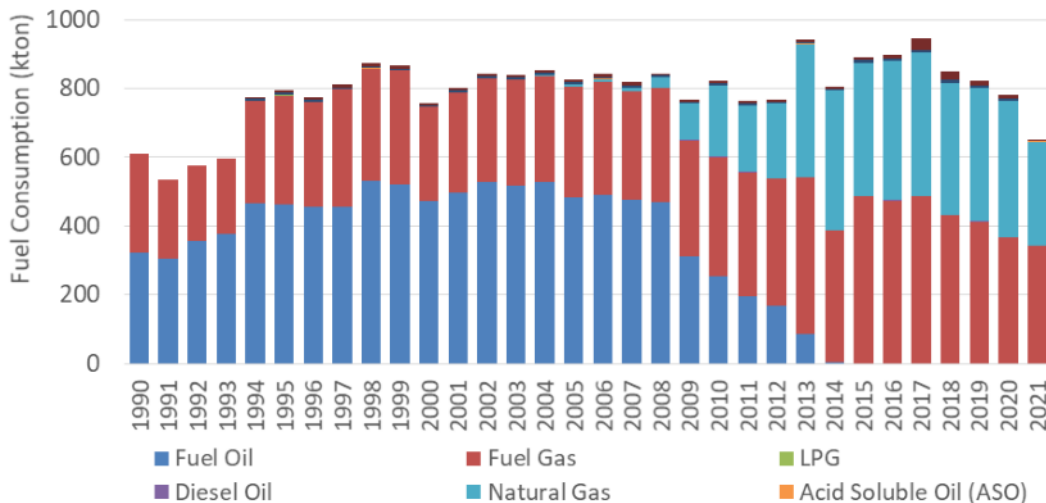

Figure 3-13: Fuel consumption in refineries

Consumption expressed in energy was calculated with the following time series of Net Calorific Values. This time series reflects actual information given by each refinery also under LCP directive (1990-2004) or EU-ETS (from 2005 onwards) and are weighted averages for all three plants.

From 2015 onwards there is no fuel oil consumption and there is an increase in fuel gas consumption. Fuel Oil CO₂ emission factor lies between 3.15-3.17 t CO₂/t fuel oil and fuel gas CO₂ emission factor lies between 2.55-2.74 t CO₂/t fuel gas. The decrease in the implied emission factor for liquid fuels is due to the increase of the contribution of a fuel with a lower emission factor (fuel gas).

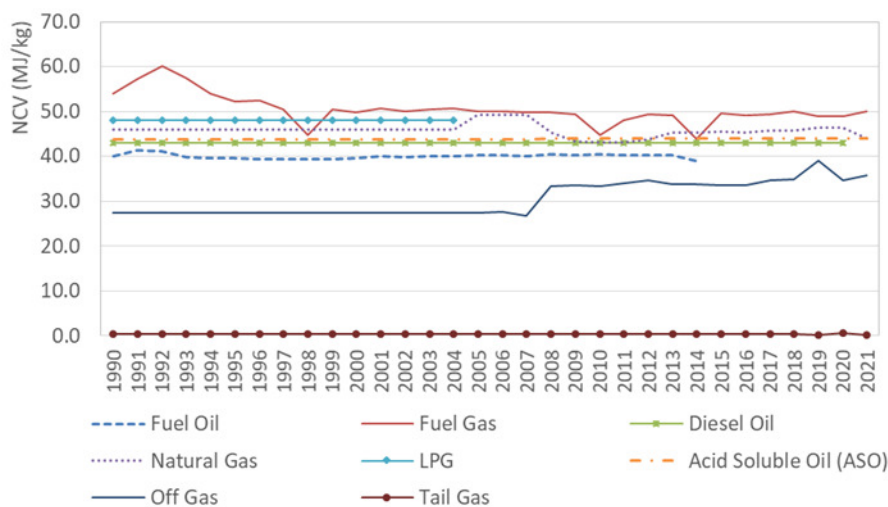

Figure 3-14: Net Calorific Value (NCV) expressed in MJ/kg by fuel type



3.3.2.5 Uncertainty Assessment

The uncertainty value was established at 1 %, in accordance with the fact that all data was obtained from direct inquiry to refinery units.

The uncertainty associated with the CO₂ emission factor is 5 %, which is the value proposed for traded fuels (IPCC, 2000). The uncertainty values in association with the other gases, methane and nitrous oxide, was also set in accordance with the GPG proposals, 150 % for CH₄ and 1000 % for N₂O.

3.3.2.6 Recalculations

No recalculations were made.

3.3.2.7 Further Improvements

No further improvements are expected.



3.3.3 Manufacture of solid fuels and other energy industries (CRF 1.A.1.c)

3.3.3.1 Category description

The following two sub-sources are included in this category:

- External fuel consumed in the coke plant that was part of the only integrated iron and steel plant in Portugal, which was dismantled in 2001 (detailed info regarding all emission streams for iron and steel operations, as well as the categories under which emissions are reported can be found in Table 4-37 and section 4.4.2.1 of the IPPU chapter). Coke gas was the only fuel combustion used as energy source in the coke plant;
- Combustion emissions done for the production of city gas that was consumed in the city of Lisbon. This activity was replaced as consequence of the substitution of this energy source by Natural Gas, and was fully deactivated in 2001.

Fugitive emissions from coke production in the coke plant are estimated and reported under category 1.B.1.b.

3.3.3.2 Methodology

Metallurgical coke production

Metallurgical coke production is considered to be an energy transformation of fossil fuel and leads to emissions of carbon dioxide (CO₂), methane (CH₄), and nitrous oxide (N₂O). This section estimates emissions of CO₂ and CH₄. No methodologies are available for N₂O emissions estimation given that, according to the IPCC guidelines, are likely to be small and therefore negligible.

CO₂ emissions from metallurgical coke production were estimated according to a carbon mass balance approach based on 2019 Refinement to the 2006 IPCC Guidelines, as shown in the following equation:

$$Emi_{CO_2} = [(C_{COAL} \times CC_{COAL}) - (COKE \times CC_{COKE}) - (COG \times CC_{COG}) - (TAR \times CC_{TAR})] \times 44/12$$

Where:

Emi_{CO₂}: CO₂ emissions (t)

C_{COAL}: Coking coal consumed (t)

CC_{COAL}: Country specific coking coal carbon content (t C/t Coking coal)

COKE: Metallurgical coke produced (t)

CC_{COKE}: Country specific metallurgical coke carbon content (t C/t metallurgical coke)

COG: Coke oven gas produced but not recirculated and therefore not consumed for metallurgical coke production (t)

CC_{COG}: Country specific coke oven gas carbon content (t C/t Coke oven gas)

TAR: Coal Tar produced (coke oven by-product) (t)

CC_{TAR}: Country specific coal tar carbon content (t C/t Coal Tar)

CH₄ emissions from stacks were estimated according to a product approach and using default emission factor (Tier 1a), described in the following equation:

$$E_{CH_4} = COKE \times EF_{CH_4}$$

**Where:**

E_{CH_4} : CH₄ emissions from coke production (t)

COKE: Quantity of coke produced (t)

EF_{CH_4} : CH₄ emission factor (t CH₄/t coke produced)

City Gas Production

For City gas production, total CO₂ and of ultimate CO₂ emissions from fossil origin were estimated according to the following equation set:

$$U_{CO_2(y)} = EF_{CO_2} \times Fac_{OX(f)} \times Energy_{Cons(u,f,y)} \times 10^{-3}$$

$$Fossil_{CO_2(y)} = U_{CO_2(y)} \times C_{Fossil(f)} \times 10^{-2}$$

Where:

$U_{CO_2(y)}$: CO₂ emissions (t)

EF_{CO_2} : Carbon content of fuel expressed in total carbon dioxide emissions (kg CO₂/GJ)

$Fac_{OX(f)}$: Oxidation factor for fuel f (ratio 0..1)

$Energy_{Cons(u,f,y)}$: Consumption of energy (Low Heating Value) from fuel f in power plant u in year y (GJ)

$Fossil_{CO_2(y)}$: Emissions of carbon dioxide from fossil origin (non biomass) u in year y (ton)

$C_{Fossil(f)}$: Percentage of carbon from fossil origin in fuel f (%)

For CH₄ and N₂O the following equation was applied to estimate emissions:

$$Emission_{(y,p)} = Energy_{Cons(f,y)} \times EF_{(f,p)} \times 10^{-6}$$

Where:

$Emission_{(y,p)}$: Emission of pollutant p in year y (t)

$Energy_{Cons(f,y)}$: Consumption of energy in fuel f (Low Heating Value) in year y (GJ)

$EF_{(f,p)}$: Emission factor pollutant p from fuel f combustion (g/GJ)

3.3.3.3 Emission Factors**Metallurgical coke production**

Emission factors used in the carbon balance for the coke plant are listed in the table below.

Table 3-13: Emission factors used in the carbon balance for the coke plant

Material	Carbon Content (t C/t material)	EF (t CO ₂ /t material)
Coking Coal	0.730	2.677
Metallurgical Coke	0.830	3.043
Coal Tar	0.801	2.937
Coke Oven Gas ¹	12.11	44.40

¹ – Carbon Content of Coke Oven Gas in kg C/GJ; EF in kg CO₂/GJ

CH₄ emission factor from coke production is reported in the table below.

Table 3-14: CH₄ emission factor from coke production

Process	Emission Factor	Unit	Source
Coke Production	0.089	kg CH ₄ /t coke produced	Table 4.2, Chapter 4 Metal Industry Emissions of the 2019 Refinement to the 2006 IPCC Guidelines



City Gas Production

Emission factors for combustion of fuel in the city gas factory are listed in the table below.

Table 3-15: Emission Factors used for the coke plant and city gas production

Source	City Gas Production			Unit	
	Fuel	FO	Naphta		NG
U _{CO2} ⁽ⁱ⁾		76.6	72.6	56.4 ⁽ⁱⁱ⁾	kg/GJ
F _{COX} ⁽ⁱ⁾		1	1	1	ratio
Fossil _C		100	100	100	%
CH ₄ ⁽ⁱ⁾		3.0	3.0	1.0	g/GJ
N ₂ O ⁽ⁱ⁾		0.6	0.6	0.1	

(i) IPCC (2006); (ii) Country Specific

3.3.3.4 Activity Data

Metallurgical coke production

From 1990 to 2001, coking coal consumption and coke, coke oven gas and coal tar production data were obtained from DGE (Coke plant Balance) and are presented in the figures below. From 2002 onwards, there is no coke production in the iron and steel industry in Portugal.

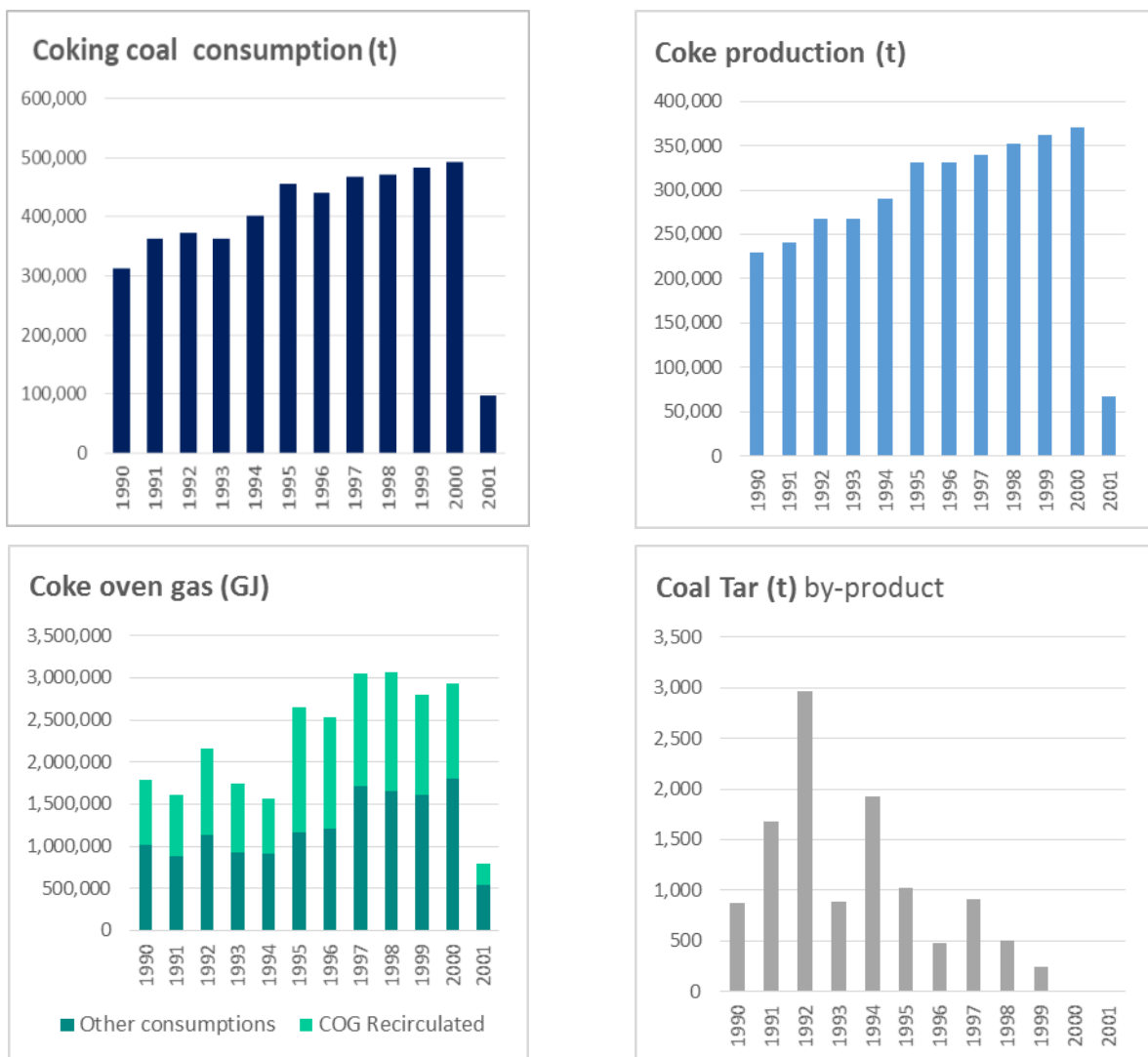

Figure 3-15: Coking coal consumption and coke, coke oven gas and coal tar production in the coke plant



City Gas Production

According to the energy balances from DGEG, this activity has used fuel oil, naphtha and, more recently, natural gas as energy sources under co-generation process, from 1990 to 2001⁹. The available time series is presented in the next figure.

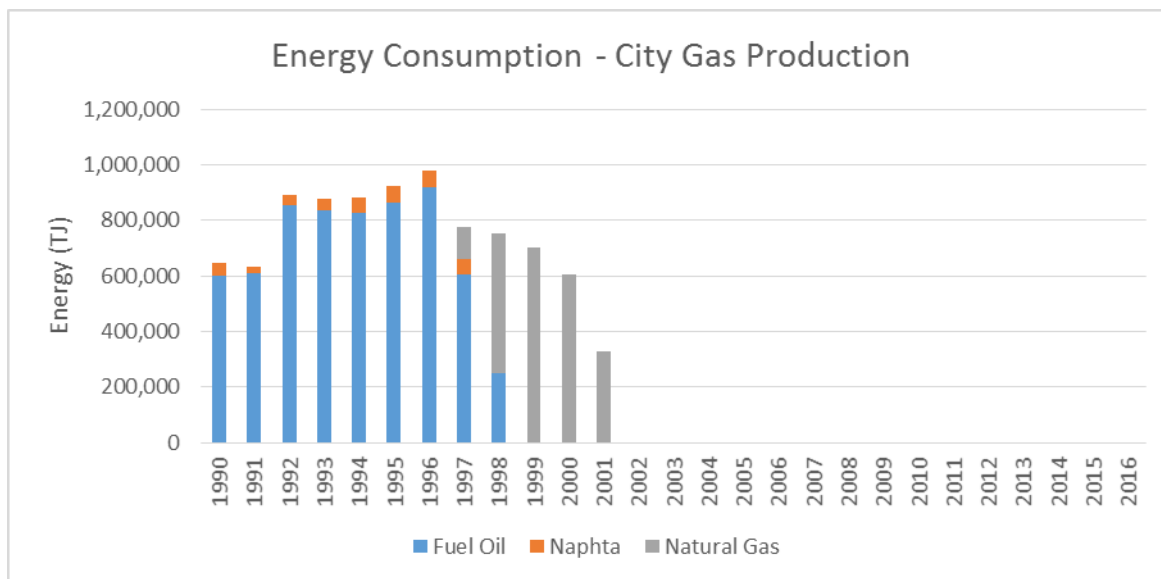

Figure 3-16: Consumption of fuels in co-generation in city gas production

All consumption of oil products as feedstock are reported in a single category in the energy balance, therefore making it difficult to determine the quantities used in city gas production alone. Therefore, all consumption of Naphta, Fuel Oil and Natural Gas is assumed to be combusted, and a methodology of energy consumption was applied.

The following Net Calorific Values (NCV) or Low Heating Values (LHV) values were used.

Table 3-16: NCV/LHV per fuel type for city gas production

Fuel	NCV (MJ/kg)
Fuel-oil	40.0
Naphta	44.0
Natural Gas	46.0

3.3.3.5 Uncertainty Assessment

10% uncertainty were assumed for both coke production activity data and emission factors, according to Chapter 4.2.3 of Volume 4: Metal Industry Emissions of the 2006 IPCC Guidelines for National Greenhouse Gas Inventories.

In the case of city gas production, in a consistent way to what was used for power plant units, an uncertainty of 4% was considered adequate.

In a similar way to all other stationary combustion sources, the uncertainty associated with the CO₂ emission factor was set at 5%, which is the value proposed for traded fuels (IPCC, 2000), and the uncertainty values for methane and nitrous oxide, are in accordance with the GPG proposed values, 150% for CH₄ and 1000% for N₂O.

⁹ This activity uses also fuel gas, LPG, fueloil, naphta and natural gas as feedstocks. These quantities, separated in the energy balance, are not included in the inventory at this point but in use of city gas as fuel.



3.3.3.6 Recalculations

No recalculations were made for city gas production nor for coke production.

3.3.3.7 Further Improvements

We intend to obtain the series of consumption of petroleum products as feedstock in the production of City Gas, in order to increase the transparency and separation between energy and non-energy consumption.

Currently, the Inventory considers that all the energy consumption reported in Energy Balance for this category were made with the purpose of supplying energy to the process. However, all the consumption of oil products as feedstock are reported in a single Energy Balance category, making it difficult to determine the quantities used only in the city's gas production.



3.4 Manufacturing Industries and Construction (CRF 1.A.2)

Emissions covered in this source category are those resulting from combustion activities in manufacturing industry and building and construction industry. CO₂ emissions from raw materials decarbonising in cement and glass industries are excluded from this category and covered under Industrial Processes (Chapters 4.2.2 and 4.2.7, respectively). The following subsections present the six UNFCCC assigned subcategories under the Manufacturing Industries and Construction category.

Total emissions for this sub-sector comprehend the sum of different industrial activities, using diverse fuels and combustion technologies and refer to the full combustion emissions of the industry sector: boilers, process dedicated fuel combustion in furnaces and kilns and all emissions originated in co-generation units¹⁰.

Table 3-17: Subcategories under the Manufacturing Industries and Construction category

CRF Code	Categories	Category description
1.A.2.a	Iron and Steel	Manufacture and casting of iron and steel
1.A.2.b	Non-Ferrous Metals	Manufacture and casting of non-ferrous metals
1.A.2.c	Chemicals	Manufacture of chemicals and chemical products
1.A.2.d	Pulp, Paper and Print	Manufacture of paper and paper products and Printing
1.A.2.e	Food Processing, Beverages and Tobacco	Manufacture of food products, beverages and tobacco products
1.A.2.f	Non-metallic Minerals	Manufacture of products such as glass, ceramic, cement, etc
1.A.2.g	Other Industries	Manufacture of metal products and machinery Manufacture of motor vehicles and other transport equipments Manufacture of wood and Wood products Manufacture of textiles, leather and footwear Manufacture of rubber products Mining of metal ores & Other mining and quarrying Offroad and other mobile machinery in industry Construction

Three key categories have been identified for this sector in 2021, for level and trend assessment, using both the IPCC Approach 1 and Approach 2:

Table 3-18: Key categories in Manufacturing Industries and Construction (CRF 1A2) and methodologies used in emission estimates

IPCC category	Gas	Criteria	Method
1.A.2 Manufacturing industries and construction - Gaseous fuels	CO ₂	L,T	T2,T3
1.A.2 Manufacturing industries and construction - Liquid fuels	CO ₂	L,T	T1
1.A.2 Manufacturing industries and construction - Solid fuels	CO ₂	L,T	T2,T3

¹⁰ Only when the co-generation activity is reported in the energy balance as referring to the manufacturing industry. When economic activity is referred as Energy Production then emissions are included in source category CRF 1A1a (See chapter 3.2.A.1 for further explanations).



In 2021, the Manufacturing Industries and Construction category accounted for 7.36 Mt (12.6%) of Portugal’s total GHG emissions, with a 18.5% (1.67 Mt) decrease in overall emissions since 1990 (refer to Table 3–15 for more details). Within the Manufacturing Industries and Construction category, 2.56 Mt (34.9%) of the GHG emissions are from the Non-metallic Minerals, which is made up of Cement, Glass and Ceramic Industries. This subcategory is followed by, in order of decreasing contributions, Other Industries (1.74 Mt, 23.7%), Chemicals (1.20 Mt, 16.4%), Pulp, Paper and Print (1.04 Mt, 14.25%), Food Processing, Beverages and Tobacco (0.71 Mt, 9.7%); and Iron and Steel (0.09 Mt, 1.2%) subcategories.

Table 3-19: Total Greenhouse Gas Emissions from Manufacturing Industries and Construction (Mt CO₂eq)

Source /Gas	1990	2005	2019	2020	2021	Δ	Δ	Δ	
	kt CO ₂ eq.					2021-2020	2021-2005	2021-1990	
						%			
1.A.2.a Iron and Steel									
CO ₂	373.3	121.4	94.3	98.0	85.2	-13.0	-29.8	-77.2	
CH ₄	0.2	0.1	0.0	0.0	0.0	-12.9	-53.8	-72.7	
N ₂ O	0.3	0.1	0.0	0.0	0.0	-12.9	-71.9	-84.1	
1.A.2.b Non-Ferrous Metals									
CO ₂	IE	IE	IE	IE	IE	n.a	n.a	n.a	
CH ₄	IE	IE	IE	IE	IE	n.a	n.a	n.a	
N ₂ O	IE	IE	IE	IE	IE	n.a	n.a	n.a	
1.A.2.c Chemicals									
CO ₂	1 411.9	1 559.4	1 334.6	1 231.7	1 198.1	-2.7	-23.2	-15.1	
CH ₄	1.6	1.8	0.8	0.8	0.7	-1.2	-58.4	-54.4	
N ₂ O	4.3	6.8	3.6	3.4	3.1	-9.5	-55.4	-29.3	
1.A.2.d Pulp, Paper and Print									
CO ₂	753.7	606.0	1 362.9	1 235.1	967.9	-21.6	59.7	28.4	
CH ₄	17.0	22.2	25.8	25.2	26.9	6.6	21.2	57.9	
N ₂ O	24.6	32.3	40.2	39.1	43.5	11.0	34.4	76.6	
1.A.2.e Food Processing, Beverages and Tobacco									
CO ₂	830.5	897.8	756.2	740.0	705.8	-4.6	-21.4	-15.0	
CH ₄	2.1	1.9	0.8	0.8	0.8	-4.6	-58.4	-61.8	
N ₂ O	9.9	10.6	6.0	6.0	5.9	-2.9	-44.6	-41.1	
1.A.2.f Non-metallic Minerals									
CO ₂	3 289.1	4 442.7	2 597.5	2 604.7	2 509.2	-3.7	-43.5	-23.7	
CH ₄	10.9	22.4	26.5	24.5	26.4	7.9	17.6	142.0	
N ₂ O	37.1	46.3	22.2	22.5	22.4	0.0	-51.6	-39.6	
1.A.2.g Other									
CO ₂	2 196.1	2 779.3	1 531.3	1 556.0	1 699.3	9.2	-38.9	-22.6	
CH ₄	4.1	5.3	3.1	3.2	3.9	22.4	-27.2	-5.9	
N ₂ O	35.7	56.3	27.8	29.8	36.1	21.0	-35.8	1.2	
Total									
CO ₂	8 854.5	10 406.7	7 676.6	7 465.5	7 165.5	-4.0	-31.1	-19.1	
CH ₄	36.0	53.8	57.0	54.5	58.8	7.8	9.3	63.4	
N ₂ O	111.9	152.5	99.9	100.9	111.0	10.0	-27.2	-0.9	
Total	All gases	9 002.4	10 612.9	7 833.5	7 620.9	7 335.3	-3.7	-30.9	-18.5

Emissions of GHG's in this category, show a growth trend between 1990 and 2005 and a reduction in emission levels in the period between 2006 and 2021. Similar to what happens in other categories of the Energy Sector.



Regarding the sub-sectors of category 1.A.2, some of them show more marked reductions (iron and steel, non metallic minerals), other sub-sectors (pulp and paper) increased their emissions. In 2009-2011 an overall reduction of emissions for all the sectors occurred due to the effects of the economic recession (refer to figure below for more details).

The expressive decrease in GHG's emissions in Iron and Steel sub-category that can be observed from 2001 to 2002 is explained by the significant changes in the only integrated iron and steel plant that existed in Portugal, particularly the closure and dismantling of the production of coke, sinter and of the blast furnace. Presently, iron and steel is produced from scrap and metallic foils.

In Chemicals sub-sector, fuel consumption was based on residual fuel oil, traded or by-product of the unit, and residual gases, also obtained as a by-product from the production processes. More recently, natural gas has gained a relevant importance as the third energy source. The introduction of Natural Gas in this sub-sector is one of the main reasons for the reduction of CO₂ emissions by about 21.2% between 2005 and 2020.

Emissions report in Paper and Paper Pulp sector include all the eight paper pulp plants that existed in Portugal from 1990 to 2020 (six Kraft plants and two bisulphite smaller plants), but also smaller units dedicated to paper production. The increasing trend in total emissions is evident and was almost continuous in the period. Except for the decreasing values in 2002-2007 that reflects a re-qualification period for one unit from fueloil to natural gas. Considering the energy sources, there is a dominance of biomass fuels (black liquor and wood waste), this explains the relative importance (> 5%) of GHG's emissions from CH₄ and N₂O, when compared to the other sub-sectors of category 1.A.2.

Non-metallic minerals emission trend is driven by the cement and ceramic industries which strongly reduced their production levels between 2009 and 2012, in relation to the economic recession and the crisis of building construction sector. GHG's emissions from Glass Industry peaked in 1998. Between 1999 and 2010, the sector saw an almost complete replacement of LPG and Fueloil by Natural Gas, which resulted in a reduction in emissions. Since 2010, GHG's emissions have remained constant in Glass Industry.

In the Other Industries sub-category, the Textile and Leather Industry (1.A.2.g.vi) sector stands out as the main responsible for GHG emissions. In such a way that it is possible to verify the effect that the transition from petroleum derived fuels to natural gas, occurred at Textile and Leather Industry, had on the total emissions of category 1.A.2.g. It is also possible to identify a similar tendency to reduce emissions due to the transition to natural gas consumption in sectors such as Manufacturing of machinery (1.A.2.g.i) and Wood and wood products (1.A.2.g.iv).

Also in Other Industries sub-category, sectors that preferentially consume petroleum-based fuels can be identified, such as Construction (1.A.2.g.v), Off-road vehicles and other machinery (1A.2.g.vii) and Mining and quarrying (1.A.2.g.iii). In these subsectors, there was also a reduction in emissions after the peak in 2005, with the most significant decrease being seen after 2012, probably influenced by the crisis of building construction sector.

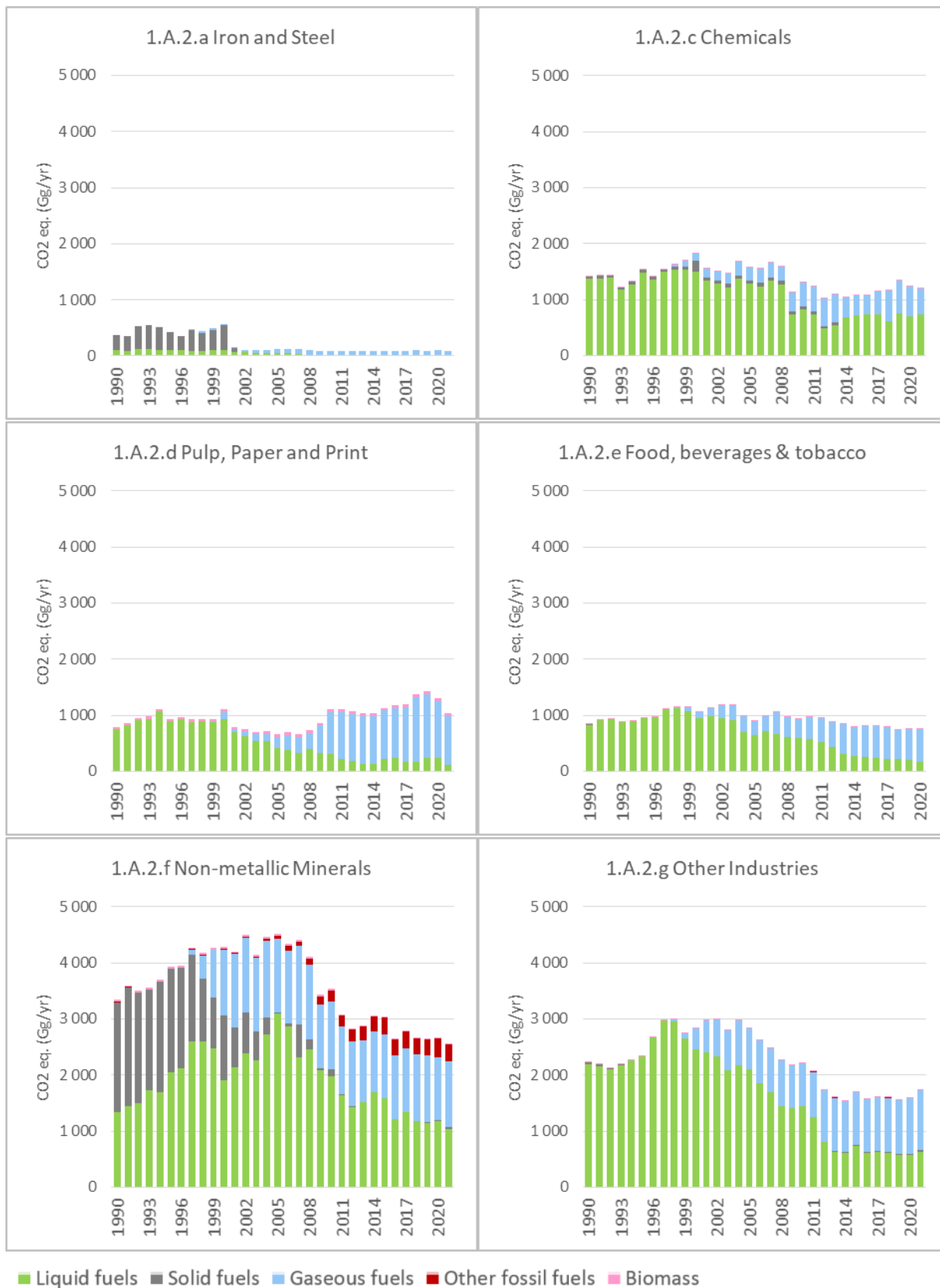

Figure 3-17: GHG's emissions from 1990 to 2020 for Manufacturing Industries and constructions subcategories



3.4.1 Methodology

Air emissions from combustion of manufacturing industries and construction are estimated using a Tier 2 methodology, but two basic approaches are used: energy approach or production approach.

According to the energy based approach, emissions are estimated multiplying emission factors by the energy consumption according to the following equations.

For carbon dioxide (CO₂), total emissions and ultimate fossil emissions are estimated using:

$$U_{CO_2(y)} = EF_{CO_2} * Fa_{COX(f)} * Energy_{Cons(u,f,y)} * 10^{-3}$$

$$Fossil_{CO_2(y)} = U_{CO_2(y)} * C_{Fossil(f)} * 10^{-2}$$

Where:

$U_{CO_2(y)}$: Emissions to atmosphere of total carbon dioxide emissions (t)

$Fossil_{CO_2(y)}$: Emissions of carbon dioxide from fossil origin (non biomass) (t)

EF_{CO_2} : Carbon content of fuel expressed in total Carbon Dioxide emissions (kg CO₂/GJ)

C_{Fossil} : Percentage of carbon from fossil origin in fuel f (%)

$Fa_{COX(f)}$: Oxidation factor for fuel f (ratio 0..1)

$Energy_{Cons(u,f,y)}$: Consumption of energy (Low Heating Value) from fuel f in power plant u in year y (GJ)

For CH₄, N₂O and other GHG when the energy consumption approach is used the equation simplifies to:

$$Emi_{(p)} = \sum_f \sum_s \sum_t [EF_{(p,f,s,t)} * Energy_{(f,s,t)}] * 10^{-6}$$

Where:

$Emi_{(p)}$: Total emissions of pollutant p (t/yr except CO₂ in kt/yr)

$EF_{(p,f,s,t)}$: Emission Factor for pollutant p, specific of fuel type f, sector activity s and technology/ combustion equipment t (g/GJ except CO₂ in kg/GJ)

Activity $_{(f,s,t)}$: Energy Consumption of fuel type f, sector activity s and technology/ combustion equipment t (GJ)

When in the production process occurs contact between combustion gases and product, which is the case of sintering and lime kilns in the iron and steel industry, cement kilns, glass ovens, ceramic ovens and dryers and lime kilns in paper pulp industry, or when combustion occurs also with the purpose of recovery of combustion products, which is the case for the recovery boiler in paper pulp industry (green liquor), emissions are more appropriately estimated using produced quantities as activity data, and the associated emission factor is expressed in kg/t. For these situations, where the production approach is used, emissions from combustion activities are estimated using the following equation:

$$Emi_{(p)} = EF_{(p)} * Production * 10^{-3}$$

Where:

$Emi_{(p)}$: Total emissions of pollutant p (t/yr except CO₂ in kt)

$EF_{(p)}$: Emission Factor for pollutant (kg/t)

Production: Production activity rate (t/yr)



It is important to point out that following a meeting with the energy balance team from DGEG new procedures were established to include biodiesel in the INERPA estimates. Hence all estimates derived from the energy balance consider biodiesel. This new approach for obtaining biodiesel results from the fact that from 2006 onwards the gas oil reported in the energy balance contained a percentage of biodiesel. The methodology for obtaining the total pure biodiesel and pure gas oil consumed in each industrial sector follows the steps¹¹:

- Total pure gas oil consumed was obtained by subtracting the total biodiesel produced (that is going to be incorporated in gas oil) to the gas oil reported in the energy balance;
- With the pure gas oil and the pure biodiesel values an incorporation rate was derived;
- For each industrial sector this incorporation rate was applied to obtain value for total gas oil and total biodiesel consumed;
- Not all the gas oil reported has biodiesel. Because of this, before applying the incorporation rate the total gas oil for heating was subtracted;
- In the end we have, for each industrial sector, the total gas oil consumed (heating gas oil plus gas oil with biodiesel removed) and the total biodiesel consumed (biodiesel from gas oil plus pure biodiesel purchased directly by the industrial unit).

The table below represents the incorporation rate derived for the period 2006-2021.

Table 3-20: Incorporation rate of biodiesel (% toe/toe)

	2006	2007	2008	2009	2010	2011	2012	2013
Incorporation rate	1.31	2.50	2.43	4.16	6.03	6.25	6.20	6.05
	2014	2015	2016	2017	2018	2019	2020	2021
Incorporation rate	5.93	6.81	5.15	5.10	5.48	5.41	5.56	5.56

When comparing the Final Consumption values considered by the Inventory with the consumption values published by EUROSTAT, we see that there is an adequate adjustment in the series. Justifying the correction that is made to the consumption data of the Energy Balance.

¹¹ Note: This procedure does not apply to gas oil reporter under co-generation in the energy balance. The DGEG has no documentation to differentiate this fuel as heating gas oil or as gas oil with biodiesel.

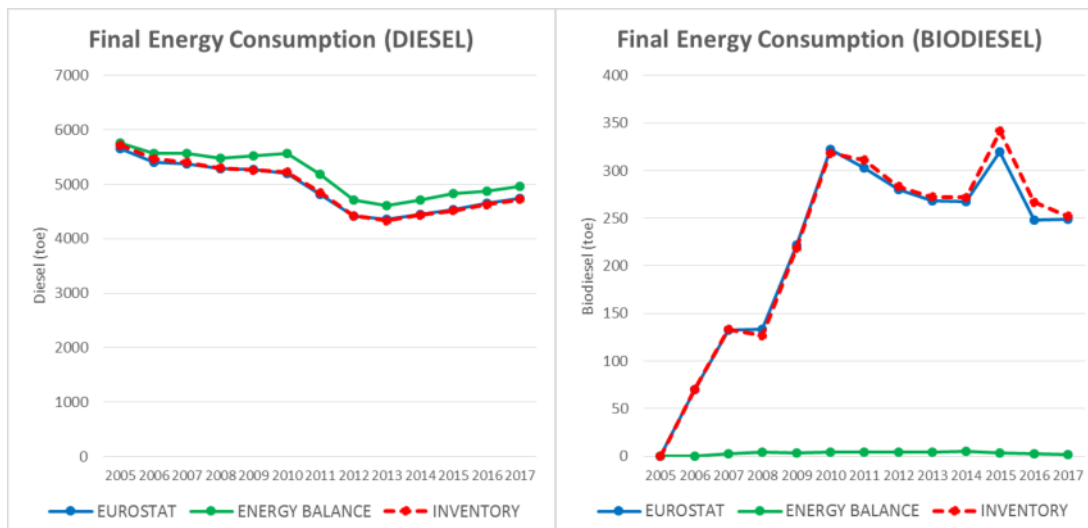

Figure 3-18: Final energy consumption for Diesel and Biodiesel

Emissions from the following industries were estimated based only on fuel consumption as activity data (energy approach): metallurgy; chemical and plastic industry; food, beverages and tobacco, textile industry; clothing, shoes and leather manufacturing; wood industry; rubber manufacturing; machines manufacturing industry and other metal equipment industry; extractive industry; building and construction and all other unspecified industry. Following the recommendation made by the review team, since the 2011 inventory all emissions from lime production are reported in 2.A.2. For the following industrial sectors specific estimation procedures were taken.

3.4.1.1 Paper and Pulp Production

Emissions of SO_x, NO_x, NMVOC and methane from the recovery boilers and lime kilns in the Kraft and Acid Sulphide paper pulp plants were estimated using production data, for each industrial plant, as activity data (production approach). The remaining pollutants emitted from these combustion equipments and all pollutants for the remaining combustion equipments of this industry sector were estimated using energy consumption as activity data (energy approach).

3.4.1.2 Clinker Production

Emissions from combustion in clinker kilns were estimated based on production data or consumption of energy obtained for each individual industrial plant, according to the original units of the emission factors. For this sector, most emission factors are plant specific and obtained from information monitored at industrial plants. The remaining fuel use in this sector that is consumed in equipments other than kilns is converted into emission using the general purpose emission factors (energy approach). CO₂ emissions from decarbonising limestone and dolomite in clinker production are addressed in IPPU chapter 4.2.2 and reported in CRF sector 2.A.1.

3.4.1.3 Lime Production

Both Lime and Clinker production are included in the energy balance of the cement sector. CO₂ emissions from decarbonising limestone and dolomite in lime production are addressed in IPPU chapter 4.2.3 and reported in CRF sector 2.A.2.



3.4.1.4 Ceramic Industry

Emissions of SO_x, NO_x, NMVOC, CH₄ and CO from combustion processes in furnaces in the ceramic industry are estimated using the production approach. Emissions estimates from combustion in other equipment, boilers and engines, and emission estimates for the other pollutants, also for furnaces, are based on the energy approach.

3.4.1.5 Glass Production

Similarly to ceramic industry, emissions of SO_x, NO_x, CH₄ and CO are estimated using production information as activity data (production approach). Emissions for the remaining pollutants, CO₂ and N₂O from furnaces and for all pollutants from other combustion equipments are estimated using energy consumption as activity data indicator. CO₂ emissions from glass production comprehend both oxidation of carbon, that are estimated using the general emission factors based on energy consumption, and decarbonising or materials, which are included in production process and are addressed in IPPU chapter 4.2.7 and reported in CRF sector 2.A.3.

3.4.1.6 Iron and Steel Production

Air emissions from sintering (SO_x, NO_x, NMVOC and CO) integrated in the iron and steel production sector are estimated using production as activity data (production approach). The remaining pollutants resulting from the iron and steel industry were estimated using the energy approach. For simplicity sake, detailed info regarding all emission streams for iron and steel operations, as well as the categories under which emissions are reported can be found in Table 4-37 and section 4.4.2.1 of the IPPU chapter.

3.4.1.7 Off-road vehicles and other machinery

This category reports combustion emissions from mobile sources in the Construction category (1.A.2.g.v) and from the Iron and Steel Industry (1.A.2.a/2.C.1).

The energy consumption considered in the Construction category obtained through the consumption of diesel reported for this sub-sector in the Energy Balance crossed with the thermal uses split according to JRC-IDEES¹² database between 2000 and 2015, allowing the separation of diesel consumption for heating and for mobile sources.

In order to obtain the energy consumption of mobile sources of the Iron and Steel industry, specific information from the installations was used, which discriminate the consumption of stationary and mobile sources.

The considered emission factors can be consulted in table 3.38 of this same report.

3.4.2 Activity data

Energy consumption for this sector is reported in the Energy Balance (see Annex 5). The data comprise specification of consumption for 14 sub-sectors and more than 30 fuels. These very detailed data, combined with EU-ETS, E-PRTR and industrial production data, allow for a good estimation of all the fuel used by most industrial sectors, with the details required by CRF format.

Activity data comprehends consumption of fuels and industrial production rates. The subsequent chapters will follow this division.

¹² JRC-IDEES is developed by the European Commission's Joint Research Centre and offers a consistent set of disaggregated energy-economy-environment historical time series from the year 2000 onwards for all EU Member States

3.4.2.1 Combustion Data

Data on fuel consumption for LPS were obtained from several sources:

- directly from Large Combustion Plants (LCP) submitted to APA under the provisions of the LCP Directive;
- information received by APA from special surveys;
- from EPER/PRTR inventory;
- from Self-control program (*Programa Autocontrolo*);
- from direct request to the LCP operators;
- since the 2009 inventory from EU-ETS.

Presently LPS comprehend one petrochemical unit, eight paper pulp plants (in most cases divided in different fiscal entities), six cement plants (covering all clinker producing units) and two iron and steel facilities.

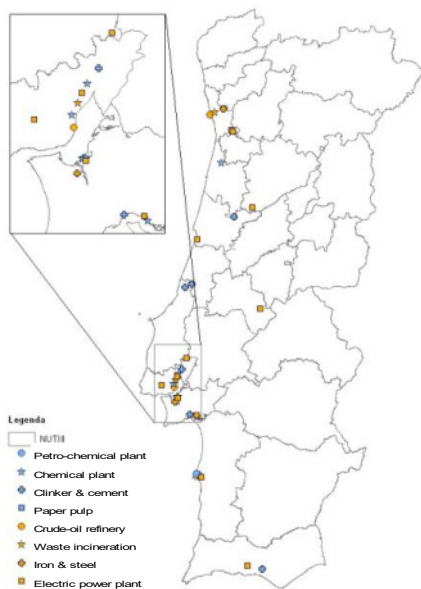

Figure 3-19: Distribution of Large Point Sources in Portugal mainland¹³

The remaining national energy consumption for each sector was estimated subtracting LPS consumption data from the figures reported in the energy balance compiled annually by DGEG and with detailed consumption data for each industrial sector and for each fuel. This procedure is synthesized in the figure below and in the following formula set:

$$\text{Cons}_{\text{EB}(f,s)} = \sum_c \{ \text{Energy}_{\text{EB}(f,s,c)} / \text{LHV}_{\text{EB}(f,s)} \}$$

$$\text{Energy}_{\text{AREA}(f,s,e)} = \{ \text{FraC}_{\text{Equi}(s,f)} * [\text{Cons}_{\text{EB}(f,s)} - \sum_u \text{Cons}_{\text{LPS}(u,f,e)}] \} * \text{LHV}_{\text{AREA}(f,s,e)}$$

$$\text{Energy}_{\text{LPS}(u,f,e)} = \text{Cons}_{\text{LPS}(u,f,e)} * \text{LHV}_{\text{LPS}(u,f,e)}$$

Where:

$\text{Energy}_{\text{EB}(f,s,c)}$: Reported energy consumption of fuel f in activity sector s, according to the energy balance, either in co-generation or not (index c) (toe/yr)

¹³ This map includes also LPS that are accounted as process emissions (CRF 2).



$Cons_{LPS(u,f,e)}$: Reported consumption of fuel f consumed by LPS unit u in equipment e (t/yr or Nkm^3/yr)

$Cons_{EB(f,s)}$: Calculated consumption of fuel f consumed in sector s , in both co-generation or non-cogeneration (c index), according to the Energy Balance (t/yr or Nkm^3/yr)

$Energy_{AREA(s,f,e)}$: Remaining energy consumption of fuel f in non-LPS – Area Sources - in activity sector s and in equipment e (GJ/yr)

$Energy_{LPS(u,f,e)}$: Energy consumption of fuel f estimated for LPS unit u in equipment e (GJ/yr)

$Frac_{Equi(s,f)}$: Fraction of consumption of fuel f in sector s that is used in equipment e (0..1)

$LHV_{LPS(u,f,e)}$: Low Heating Value/ Net Calorific Value, reported by LPS unit u , for fuel f in combustion equipment e (MJ/kg or MJ/ Nm^3)

$LHV_{EB(f,s)}$: Low Heating Value/ Net Calorific Value used by DGEG in the compilation of the Energy Balance for fuel f in activity sector s (toe/t or toe/ Nkm^3)

$LHV_{AREA(f,s,e)}$: Low Heating Value/ Net Calorific Value used in the Inventory for fuel f in equipment e for area sources (combustion in non LPS) (MJ/kg or MJ/ Nm^3)¹⁴

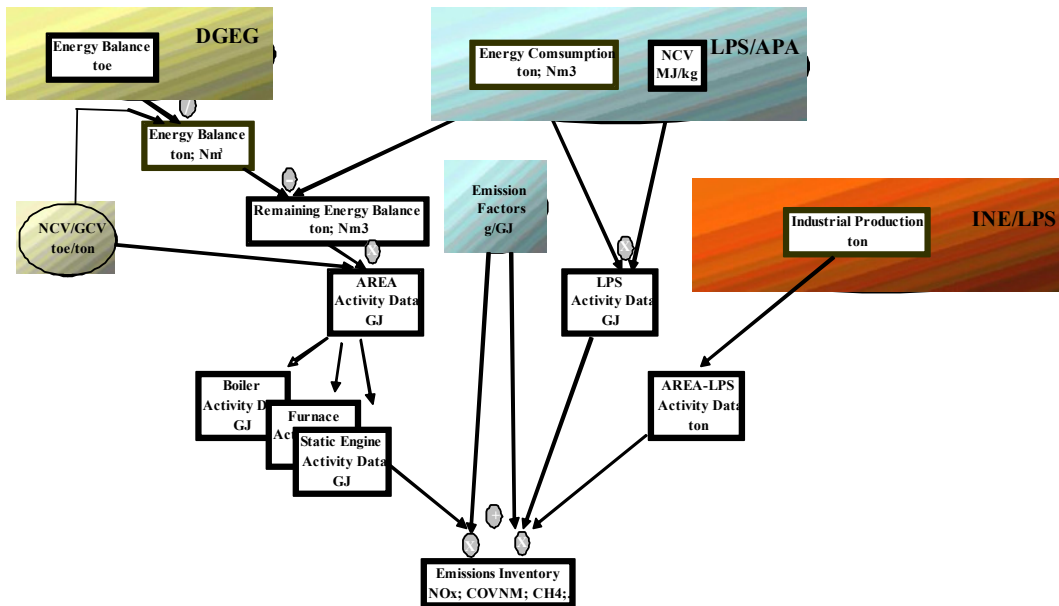

Figure 3-20: General procedure for emissions estimate

Characterization of the combustion equipments was also taken from LPS sources, as well as some characteristics of the fuels. For the non LPS sources, or the remaining energy consumed that are accounted in the energy balances, there is no detailed information about in which equipment combustion takes place, apart from division between co-generation and non co-generation. Hence separation of fuel consumption among boilers, furnaces and engines was made by expert judgment according to each economic sector, and also considering that the original data of fuel consumption in the DGEG’s energy balances make a separation between quantities used in co-generation and quantities used without co-generation.

¹⁴ In most cases similar values to Energy Balance are used



3.4.2.2 The Energy Balance

The Portuguese Energy Balance (EB) is published annually by DGEG covering all national territory and without any disaggregation at regional level. The structure of the report table is summarized in the next tables. The Energy Balance for 2021 is presented in ANNEX A.

Table 3-21: Structure of the Portuguese Energy Balance. Sectoral categories

Primary	Imports	Co-generation	Electric producers	Final Consumption	Agriculture		
	Indigenous Production		Barreiro power plant		Fisheries		
	Stock variations		Crude oil refineries		Mining Industry		
	Exports		City gas		Food and Beverages		
	Foreign ships		Agriculture		Textile		
	Foreign aircraft		Food and Beverages		Paper pulp and paper		
	Primary Energy Consumption		Textile		Chemical and Plastics		
For production of secondary energy sources	Briquettes		Paper pulp and paper		Manufacturing Industry	Ceramic	
	Coke		Chemical and Plastics			Glass	
	Crude oil products		Ceramic			Cement	
	City gas		Glass			Metalurgy	
	Petro-chemical		Cement			Iron and steel	
	Electricity		Metalurgy			Cloth, shoes, leather	
			Iron and steel			Wood	
Consumption in the Energy sector	Refineries (own consumption)		Cloth, shoes, leather			Transport	Rubber
	Refineries (losses)		Wood				Equipment
	Coquerie		Rubber				Other Manufacturing Industries
	Electric Power Plants	Equipment	Construction and Public Works				
	Hidropower pumping	Other Manufacturing Industries	National airplanes				
	City gas	Extractive	National ships				
	Mining Industry	Services	Railways				
Transport and distribution (losses)		road					
Feedstocks			Domestic				
Corrections			Services				

Table 3-22: Structure of the Portuguese Energy Balance. Fuel categories

Coal	Imported coal	Non Energy Products	Lubricants
	National coal		Asphalts
	coal coke		Parafin
	Solvents		
Oil	Intermediate refinery products	Electricity	Hydro-electricity
	LPG		Wind and Geothermal
	Gasoline	Thermo-electricity	
	Kerosene		
	Jets		
	Diesel oil		
	Residual fuel oil		
	Naphta		
Petro coke			
Gases	Natural gas		
	City Gas		
	Coke oven gas		
	Blast Furnace gas		
	Petrochemical gas		
Hydrogen			
Other	Tar		
	Wood and vegetable wastes		
	Solid Urban Waste		
	Industrial Waste		
	Biogas		
	Biodiesel		
	Liquors		
Other			

The sub classes presented below represent the most detailed information available limited by the detail reported in the National Energy Balances from DGEG. Each group represents an aggregation of specific Categories of Economic Activities (CAE).

**Table 3-23: Definition of Sectors in accordance with Economic Activity Classes**

Sub sector	EAC (1977)
Agriculture	111, 112, 113, 121, 122
Fisheries	130
Extractive Industry	220, 230, 290
Food processing, beverages and tobacco	311, 312, 313
Textile	321
Paper and paper pulp	341
Chemical and Plastic Industry	351, 352, 356
Ceramic	361, 3691
Glass	362
Cement	369 except 3691
Metallurgy	271, 272 except Iron and Steel
Iron and Steel Industry	Iron and Steel
Clothing, shoes and leather	322, 323, 324
Wood & wood products	331, 332
Rubber	355
Manufacturing of machines and metallic Equipments	381, 382, 383, 384
Other	390, 314, 342, 385
Construction & Building	500

3.4.2.3 Industrial sector energy profiles

In this section the energy profiles of the different sub-sectors are described, considering consumption, share of fuels, emissions intensity and source of data.

The figures below represent the energy consumption for Manufacturing Industries and Construction for the different sub-sectors and level of information disaggregation – data from industrial plants or data from subsector of the national Energy Balance.

Iron and Steel (1.A.2.a) – Both facilities are included in EU ETS. Activity data information was also collected via a questionnaire, sent directly to the plants' operators.

Chemicals (1.A.2.c) - EU-ETS data from petrochemical facilities are considered. The remaining energy consumption of this subsector is collected through the Energy balance.

Pulp, Paper and Print (1.A.2.d) - Most of the operators in the paper and pulp sector are included in EU ETS, while only a few of the printing installations are included.

Food, beverages & tobacco (1.A.2.e) - A comprehensive activity data for this sector is not available; the subsector comprises many small and medium size enterprises, with thousands of different products. Limited info on this sector can be found in ETS survey, the sector is not included in the scope of ETS.

Non-metallic minerals (1.A.2.f) - This sector comprises emissions from many different industrial subsectors, some of which are subject to EU ETS and some not. Cement Industry subsector is energy intensive and it is subject to EU ETS. However, in the construction material subsector (Ceramic Industry), there are many small and medium sized enterprises, so the operators subject to ETS are only a part of the total.

Other Industries (1.A.2.g) - This sector comprises emissions from many different industrial subsectors, mainly not subject to EU ETS.

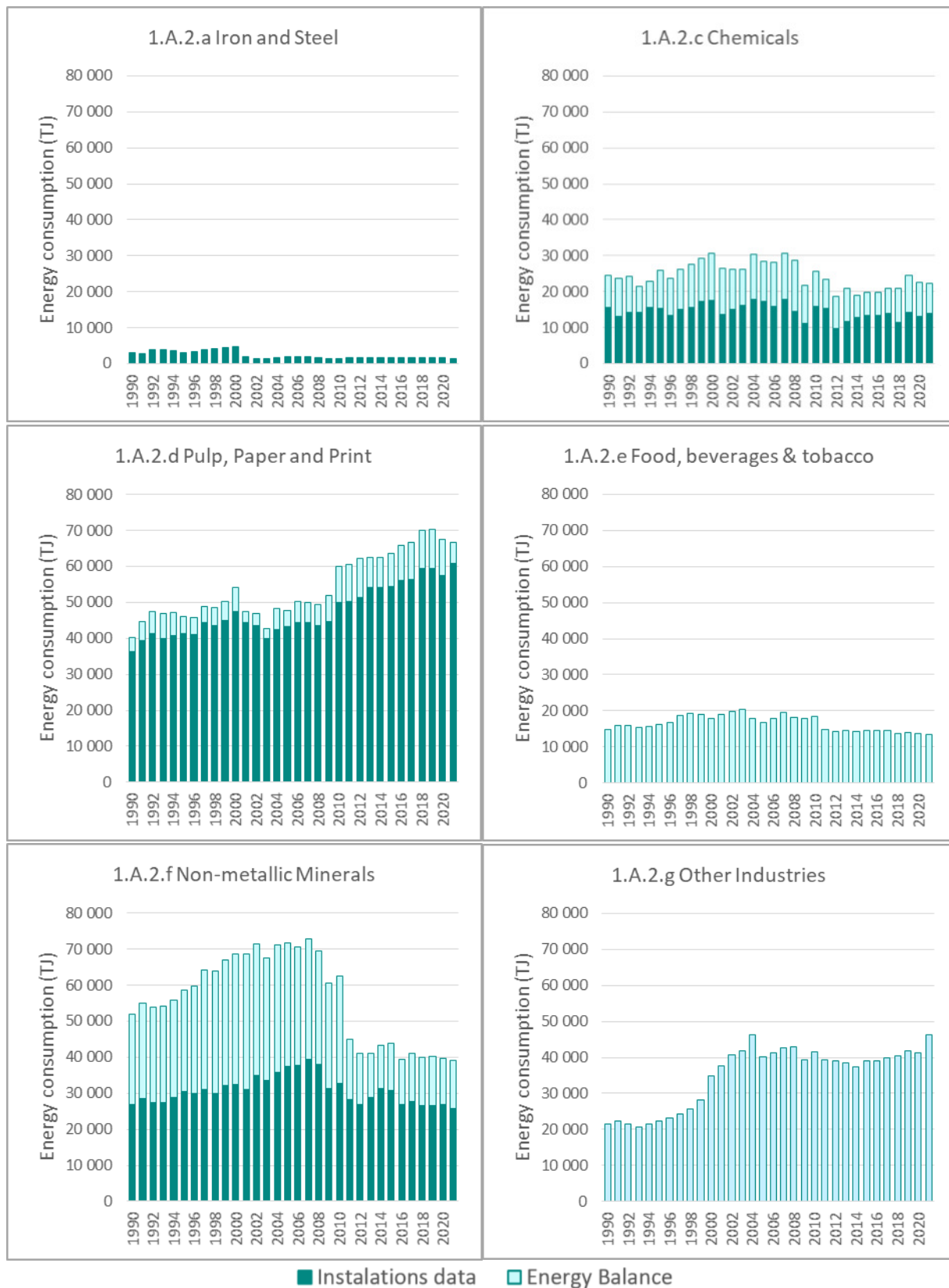
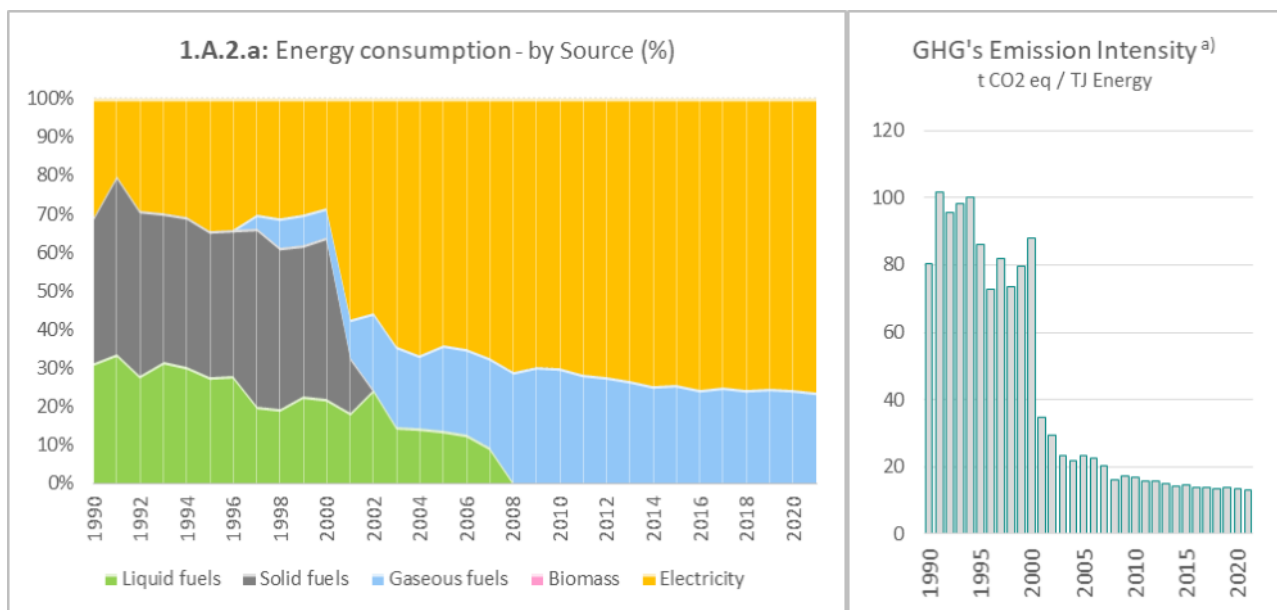

Figure 3-21: Total Energy Consumption in Manufacturing Industries and Construction



3.4.2.3.1 Iron and Steel Industry (CRF 1.A.2.a)

There are two distinct periods in recent history of the Iron and Steel sector in Portugal: between 1990 and 2001, when one of the plants operated on an integrated regime (coke production, sinter production, pig iron production and BOF steel production), and from 2002 onwards, when the two iron and steel plants only produced steel using the electric arc furnace and scrap and metallic foils as raw materials. This change has also caused substantial changes in the contribution of fuels, with the cessation of coke oven gas and blast furnace gas (solid fuels), and the increase in the use of natural gas (gaseous fuels), that not only was used to replace the other by-product gases, but also partially the use of LPG and residual fuel oil (liquid fuels). The change from the Basic Oxygen Furnace to the Electric Arc Furnace in one of the facilities also meant an increase in electricity consumption, which became the main source of energy from 2002 onwards.



a) GHG's Emission Intensity is estimated considering the total emissions of greenhouse gases (CO₂, CH₄ and N₂O) reported in category 1.A.2.a Iron and Steel in relation to the total energy consumed (fossil fuels, biomass and electricity). CO₂ emissions from biomass as well as GHG's emissions associated with electrical production are not included in the calculation of this parameter, as they are considered in the estimates of other categories of the Inventory.

Figure 3-22: Share of energy consumption by source & Greenhouse gases emissions intensity

The trend of emissions intensity is also marked by changes in steel production methods. By abandoning the integrated regime and the Basic Oxygen furnace, GHG's emissions associated with combustion are significantly reduced. It is also possible to identify the transition period between liquid and gaseous fuels between 2002 and 2008. Natural gas is currently the main source of fossil emissions from the energy component of this sector used in rolling mills.

Detailed info regarding all emission streams for iron and steel operations, as well as the categories under which emissions are reported can be found in Table 4-37 and section 4.4.1.1 of the IPPU chapter.

3.4.2.3.2 Non-Ferrous Metals

The Portuguese Energy Balance does not have disaggregated information for the industrial sub-sector "Non-Ferrous Metals". When asked where these consumptions were included, it was clarified by DGEG, the national energy authority that these consumptions would be included in the category corresponding to the Metallurgy Industry.

Since it is impossible to determine the consumption of the industrial sub-sector "Non-Ferrous Metals", emissions from 1.A.2.b are allocated in Manufacturing of Machinery (1.A.2.gi).



3.4.2.3.3 Chemical and Plastics Industry

Two industrial plants in this sector were treated as Large Point Sources, representing a substantial component of total energy consumption. In the beginning of the period under analysis, fuel consumption was based on residual fuel oil, traded or by-product of the unit, and residual gases, also obtained as a by-product from the production processes. The consumption of coke time series presents an anomalous value in 2000. When questioned about this, the energy balance team at DGEG could not justify the inconsistent value.

The trend towards a reduction in the intensity of GHG emissions that occurred after 2000 is essentially due to the change in consumption between residual fuel oil and natural gas.

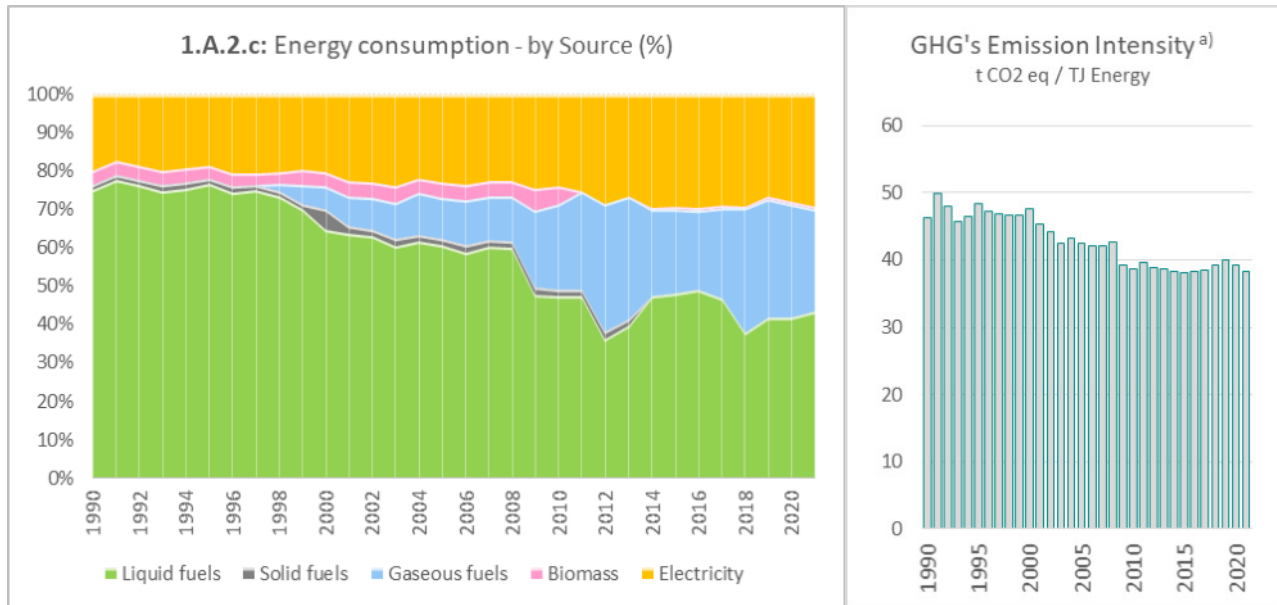

a) GHG's Emission Intensity is estimated considering the total emissions of greenhouse gases (CO₂, CH₄ and N₂O) reported in category 1.A.2.c Chemicals in relation to the total energy consumed (fossil fuels, biomass and electricity). CO₂ emissions from biomass as well as GHG's emissions associated with electrical production are not included in the calculation of this parameter, as they are considered in the estimates of other categories of the Inventory.

Figure 3-23: Share of energy consumption by source & Greenhouse gases emissions intensity

3.4.2.3.4 Paper and Paper Pulp Industry

Black liquor is the main source of energy in the pulp production plants, and throughout the time series it is responsible for more than 50% of energy consumption. Other relevant fuels in this subsector are wood and wood products, residual fuel oil and natural gas. These last two have different periods of use - Fuel oil being the main auxiliary fuel between 1990 and 2007, which would later be replaced by Natural Gas, which has gained main prominence since 2010, even replacing some consumption of wood products.

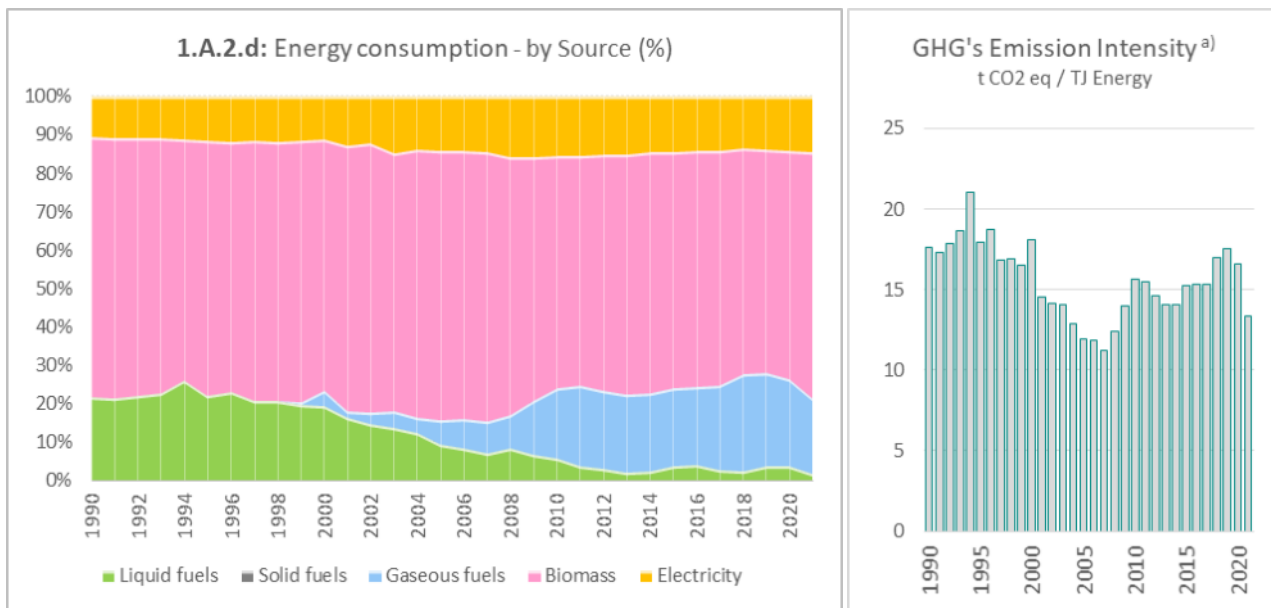

a) GHG's Emission Intensity is estimated considering the total emissions of greenhouse gases (CO₂, CH₄ and N₂O) reported in category 1.A.2.d Pulp, Paper and Print in relation to the total energy consumed (fossil fuels, biomass and electricity). CO₂ emissions from biomass as well as GHG's emissions associated with electrical production are not included in the calculation of this parameter, as they are considered in the estimates of other categories of the Inventory.

Figure 3-24: Share of energy consumption by source & Greenhouse gases emissions intensity

The use of Biomass (black liquor and wood products) as the main source of energy makes this subsector a low emitter when analyzing GHG's Emissions Intensity. The variations in Emission Intensity that occur over the time series are related first to the replacement of liquid fuels with gaseous fuels (1997-2007) and later by the increase in natural gas consumption (2007-2020).

3.4.2.3.5 Food Processing, Beverages and Tobacco

Like other sectors of the industry, the Food Industry sub-sector saw large consumption of fuel oil residuals in the early 1990s, with other preferred fuels being LPG and Wood products. Like other subsectors, the introduction of Natural Gas in Portugal in 1997, revolutionized the consumption profile of this industry. Natural gas currently covers about 45% of total consumption. It is important to mention the electrification that has been taking place in this sector, electricity consumption in 2020 was twice as high as in 1990, and is now responsible for around 30% of total energy consumption.

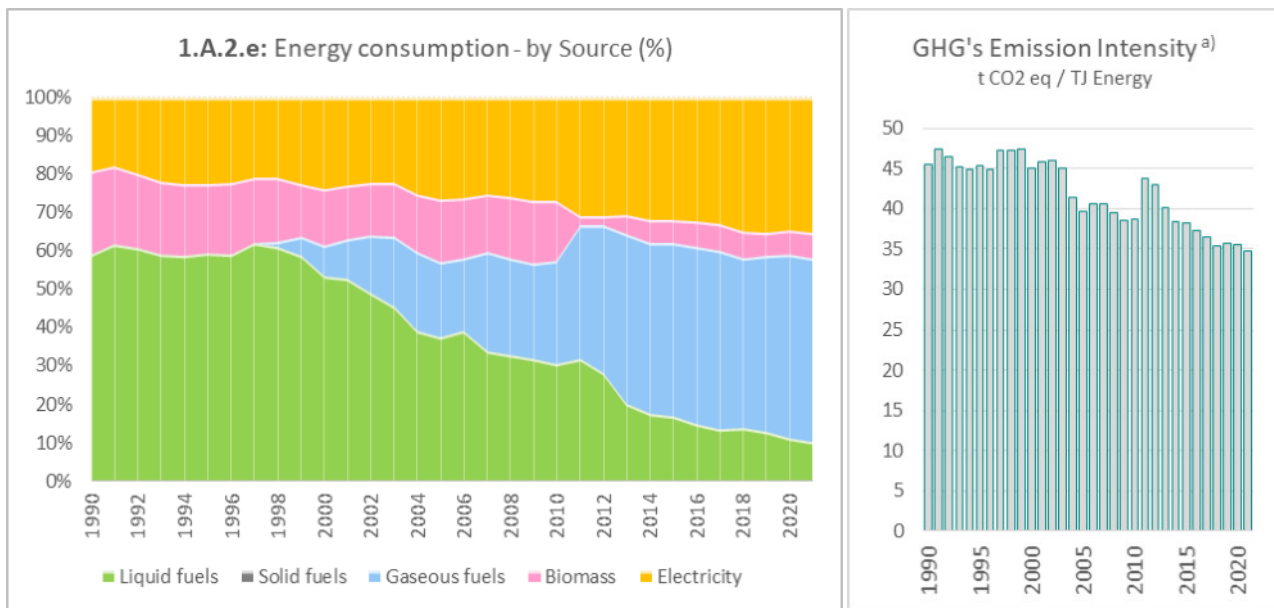

a) GHG's Emission Intensity is estimated considering the total emissions of greenhouse gases (CO₂, CH₄ and N₂O) reported in category 1.A.2.e Food Processing, Beverages and Tobacco in relation to the total energy consumed (fossil fuels, biomass and electricity). CO₂ emissions from biomass as well as GHG's emissions associated with electrical production are not included in the calculation of this parameter, as they are considered in the estimates of other categories of the Inventory.

Figure 3-25: Share of energy consumption by source & Greenhouse gases emissions intensity

The transition from petroleum-based fuels to natural gas is the driver of the trend towards reducing GHG's Emission Intensity. However, there is an anomaly in 2011 and 2012, due to Biomass consumption values especially low for the sector.

3.4.2.3.6 Non-metallic Minerals

Category 1.A.2.f Non-Metallic Minerals enfold emissions from fuel combustion in cement, lime, glass and bricks & tiles industries.

In the early 1990s, the breakdown of sectors by type of fuel used was evident. With a large part of the cement industry being fueled by coal combustion, the glass industry preferably used fuel oil and Ceramicas with a combination of biomass and LPG combustion.

Once again a milestone in the consumption of fossil fuels in the Portuguese industry was the introduction of Natural Gas. However, the transition occurred at different times for the sub-sectors. The first sub-sector to adopt natural gas was the glass industry, becoming the main fuel from 2000 onwards.

In the case of the Ceramics industry, the introduction of natural gas was slower, with the energy consumption of the subsector being divided between Biomass and Natural Gas until 2012, when after a significant drop in the consumption of Biomass, Natural Gas becomes the main fuel consumed.

In the lime-producing industry, the consumption of natural gas began in the year 2000, with one of the main factories starting the transition from petroleum-derived fuels to natural gas. This option to use natural gas as the main fuel was also verified in new installations that started working after 2017, which made natural gas the main source of energy for the lime production industry.

The cement industry underwent a different transition, with the substitution of coal for petroleum coke between 1998 and 2005. As of 2008, and after a political decision, the incineration of tires and other industrial waste started in Portuguese cement plants. Currently, the combustion of other fossil fuels represents about 25% of energy consumption in the cement industry.



The incineration of residues in the cement plants began in 2005. The main residues burned are used tyres, RDF, fluff, animal and vegetable residues and hazardous industrial residues. Thus increasing the share of "Other fossil fuels" in the subcategory to around 10%.

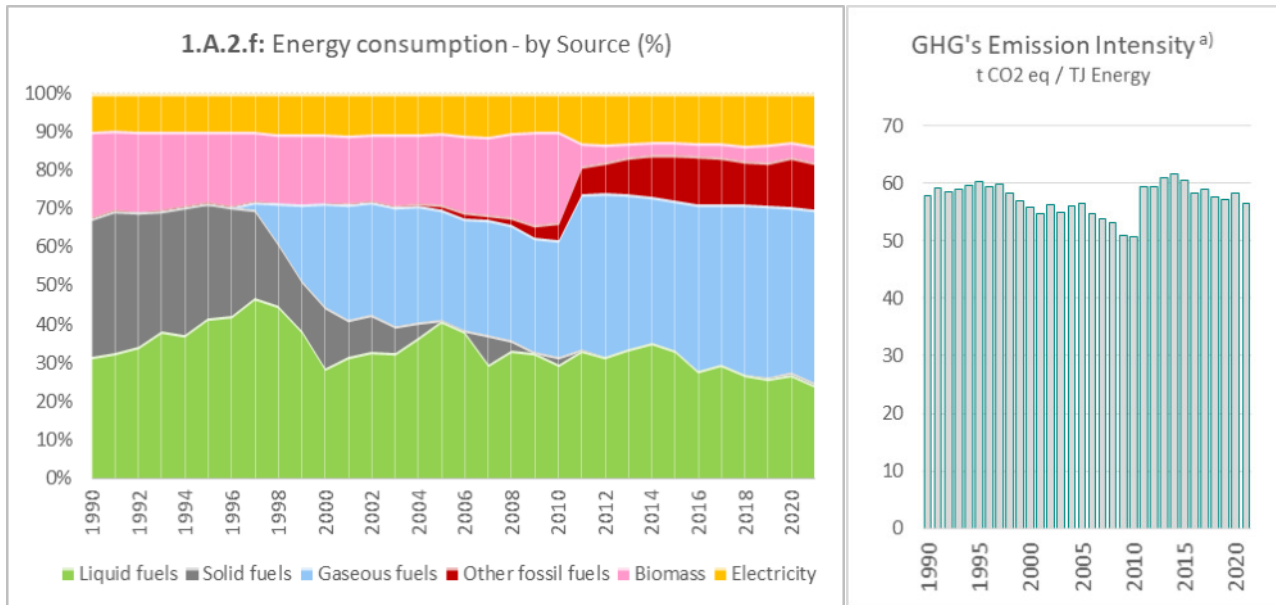

a) GHG's Emission Intensity is estimated considering the total emissions of greenhouse gases (CO₂, CH₄ and N₂O) reported in category 1.A.2.f *Non-metallic Minerals* in relation to the total energy consumed (fossil fuels, biomass and electricity) . CO₂ emissions from biomass as well as GHG's emissions associated with electrical production are not included in the calculation of this parameter, as they are considered in the estimates of other categories of the Inventory.

Figure 3-26: Share of energy consumption by source & Greenhouse gases emissions intensity

Regarding the Intensity of GHG Emissions, the sector underwent a reduction in intensity when transitioning from oil-based fuels to natural gas. There is a significant increase after 2011, due to the sharp decrease in the consumption of Biomass in the ceramic industry.

In the next figure it is possible to observe in greater detail the energy consumption of the main subsectors of category 1.A.2.f. It is evident that both the Ceramic Industry, Lime Production and Glass Production had a transition between liquid fuels and natural gas, however in the cement production industry the transition happened differently.

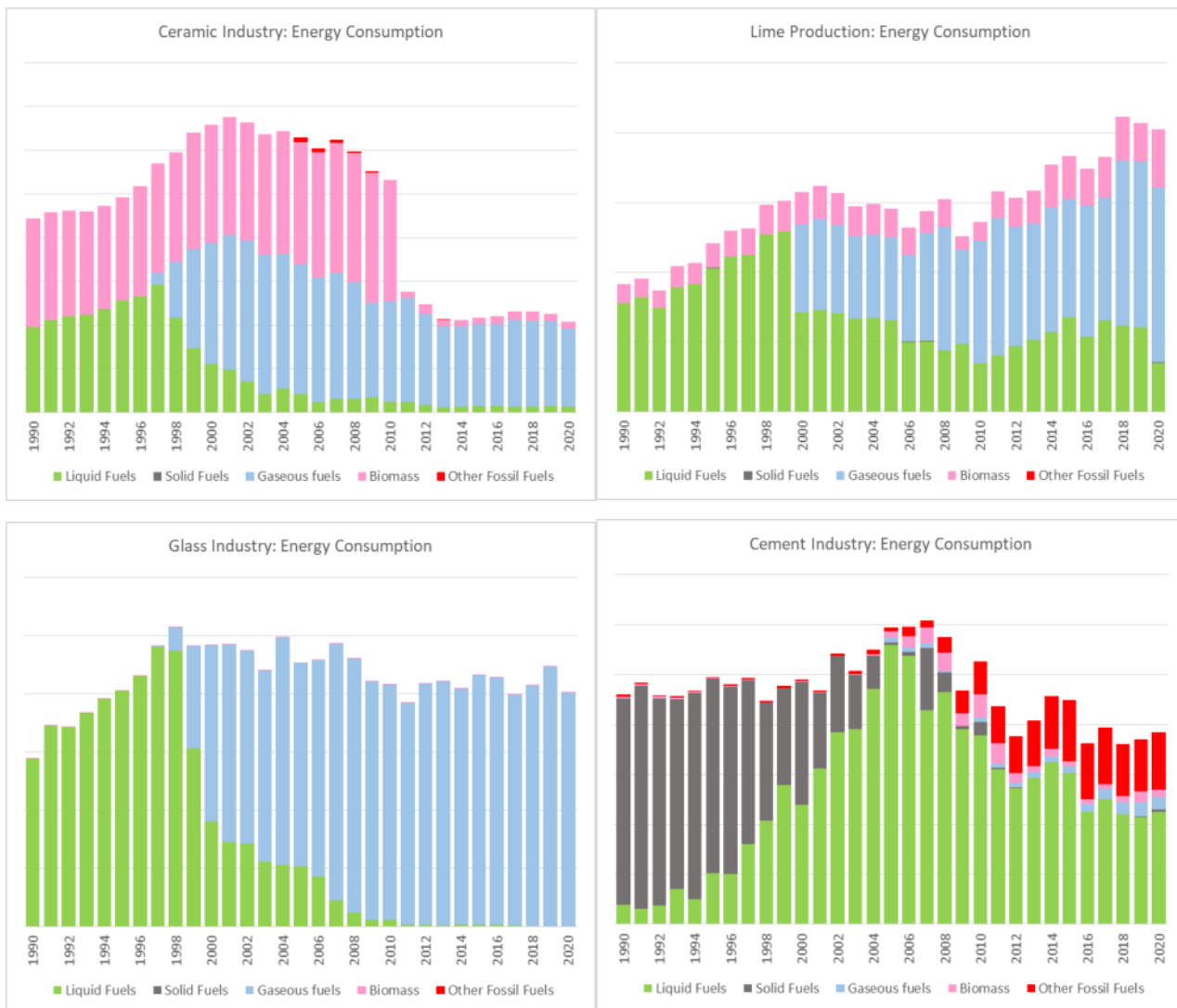
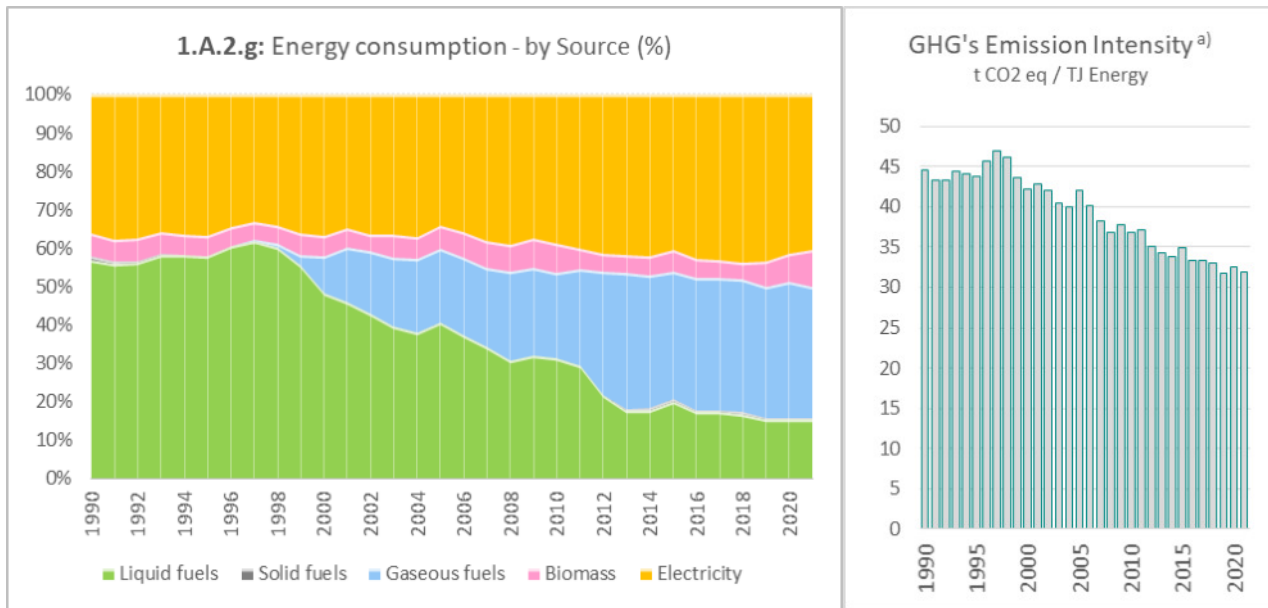

Figure 3-27 Energy consumption for the 4 main sub-sectors of category 1.A.2.f broken down by fuel type.

3.4.2.3.7 Other Industries

This category comprises several industrial subsectors that are classified as light industry. This allows for greater electrification of energy consumption, with electricity accounting for around 35%-40% of the total energy consumed. Regarding fossil fuels, here it is also possible to identify an option for more "lighter" fuels, with LPG and Gasoil being used more prominently than fuel oil. The introduction of Natural Gas in Portugal in 1997 initiated a transition process for these industrial sectors, thus exchanging petroleum-based fuels for Natural Gas. Currently, only Diesel remains as a prominent fuel to be consumed preferably in the extractive and construction industry.

Regarding the Intensity of GHG Emissions, the sector saw a reduction in intensity when transitioning from oil-based fuels to natural gas with lower carbon content.



a) GHG's Emission Intensity is estimated considering the total emissions of greenhouse gases (CO₂, CH₄ and N₂O) reported in category 1.A.2.g Other Industries in relation to the total energy consumed (fossil fuels, biomass and electricity). CO₂ emissions from biomass as well as GHG's emissions associated with electrical production are not included in the calculation of this parameter, as they are considered in the estimates of other categories of the Inventory.

Figure 3-28: Share of energy consumption by source & Greenhouse gases emissions intensity

3.4.2.4 Comparison of LPS data vs. Energy Balance

Total consumption in LPS per sector was compared with the correspondent value in the energy balance for the most important fuels, in order to verify the applicability of the methodology in use, which mixes a top-down approach (EB) with a bottom-up approach (LPS data). The following figures present the comparison done for sectors: (1) Paper Pulp; (2) Chemical Manufacturing; (3) Cement Industry and (4) Iron and Steel Plants.

Before hand, it must be realized that to conclude for consistency between both distinct datasets, the comparison should result in higher or equal consumption in the EB than in the inventory, because apart from specific fuels (black liquor in the paper and pulp industry, coke oven gas and blast furnace gas in the iron industry, and coal, coke and tires in the cement industry) the universe considered by the Energy Balance covers more units than the set of LPS (E.g. the paper and paper pulp sector also includes consumption in the manufacturing of paper, for which there are several small units).



Black Liquor

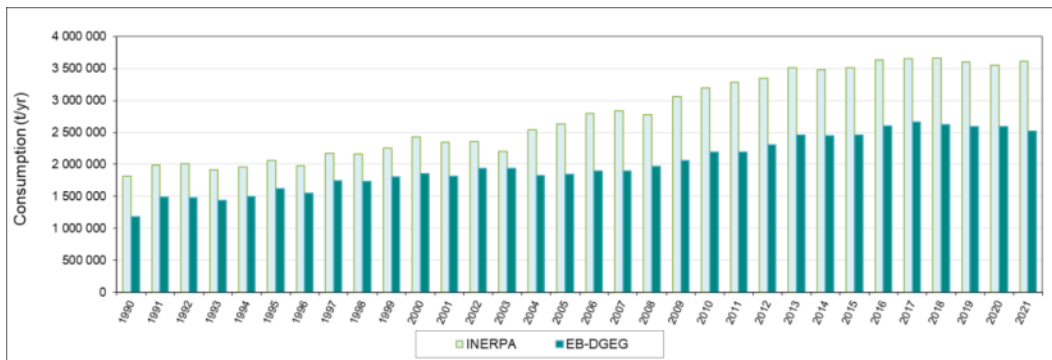

Residual Fuel Oil

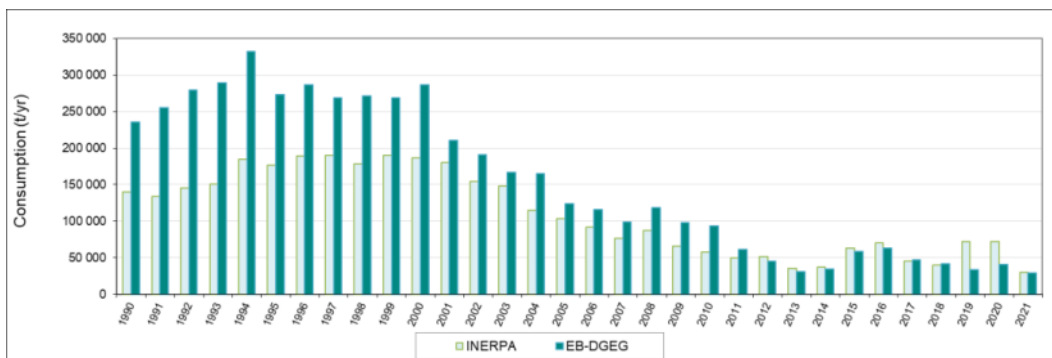

Biomass

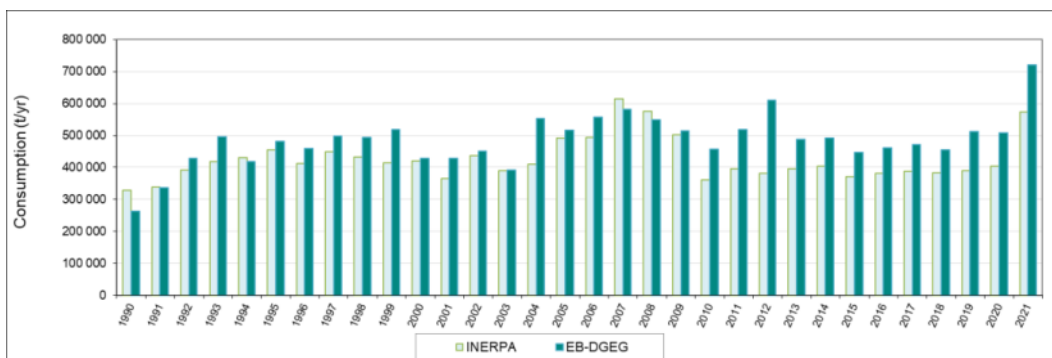

Natural Gas

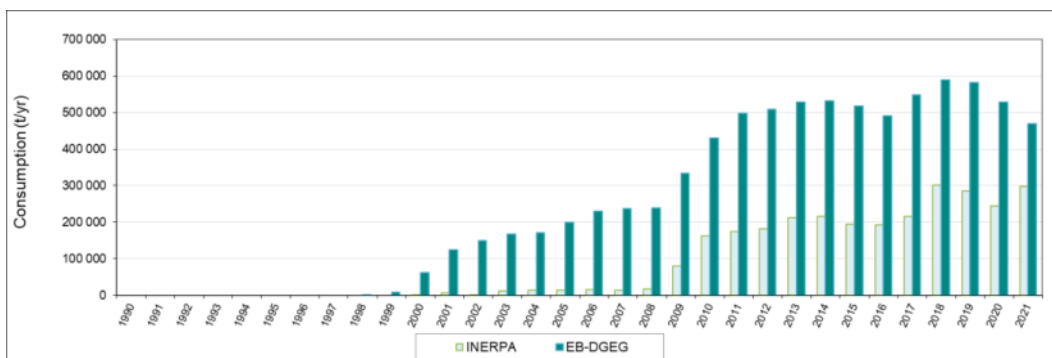

Figure 3-29: Comparison of total LPS consumption in Paper Pulp units with the reported consumption in the EB for the sector "Paper pulp and paper production"

The comparison made for the paper and pulp industry shows that differences occur, but are not substantial for the major fuels: black liquor and biomass. Part of the differences were analysed before (DGEG,2003) and could be explained by the use of different LHV in the Energy Balance, which occurs commonly for biomass fuels, given the variability in water content. Careful estimations were made not double count the emissions.

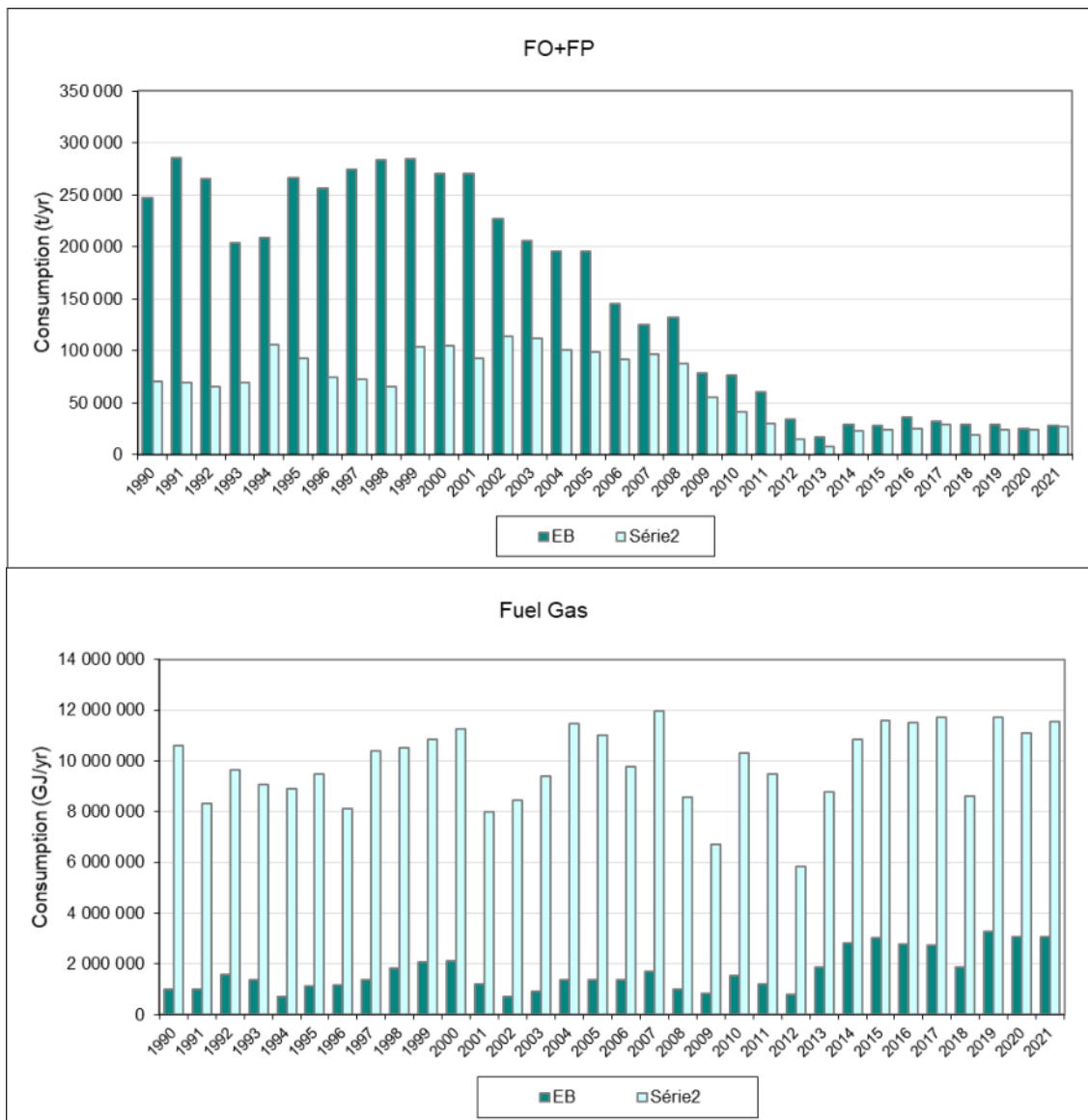

Figure 3-30: Comparison of total LPS consumption in Petrochemical units with the reported consumption in the EB for the sector “Chemical and Plastics”¹⁵.

For the Petrochemical industry the comparison shows that the share of LPS in the consumption of residual fuel oil¹⁶ is about 50 % until 2005. The two values show a tendency to converge in the later years. Also important to note that in 2012 LPS values surpass energy balance data by 8 %. Consumption of fuel gas as reported from the LPS data shows much higher values than in the EB. After consultation with DGEG it was realized that the EB does not covers consumption of fuel gas that is not traded or used in co-generation.

The match for the iron and steel industry show a good consistency, except for intermediate years, and for the slightly higher consumption of Blast Furnace Gas. This last difference may result from the use of different LHV values.

¹⁵ Units in the vertical axis are not indicated due to confidentiality issues.

¹⁶ This category includes residual fuel oil, a traded fuel, and fuel pyrolysis, a non-traded by product fuel, used inside the industrial unit that produces it.

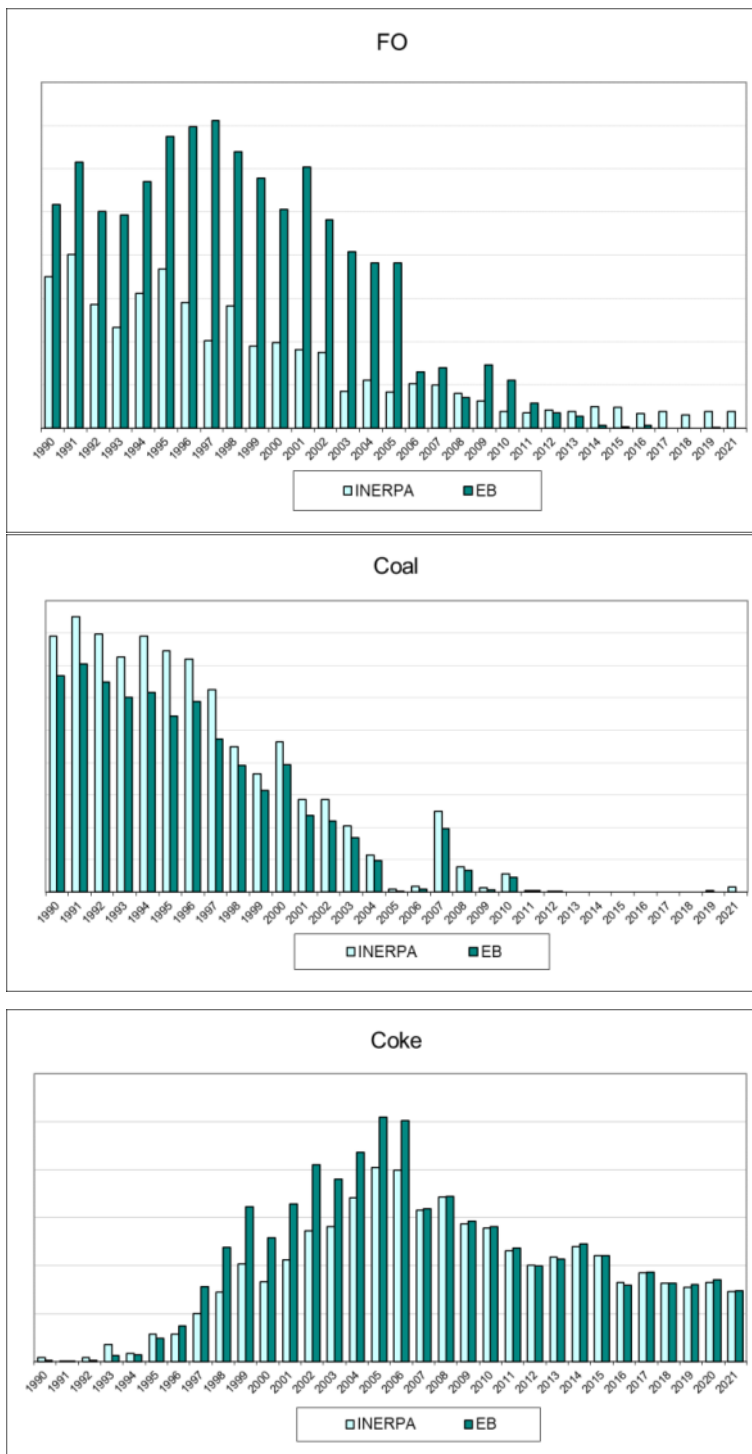

Figure 3-31: Comparison of total LPS consumption in Cement Plant with the reported consumption in the EB for the sector “Cement and Lime” (Due to confidentiality issue y axis values are not shown)

Concerning the cement industry, an acceptable coherence exists between both information sources, except for fuel oil consumption which can be explained by the inclusion of lime production in this energy balance category.

In conclusion, the analysis indicates that albeit certain differences, there is an acceptable agreement between both data sets. Nevertheless, efforts should be maintained in order for the streamlining of data between the inventory and the energy balance, and for the inclusion of all fuels, either traded or not, in the energy balance.



3.4.2.5 Production Data

The production activity rates that were used to estimate of air emissions (production approach) are presented in the tables below. Although for some activities, such as cement production, emissions were estimated at plant level with plant specific emission factors this information was considered confidential and may not be published in NIR.

Total production of paper pulp is reported in Table 3.61. Production data for Kraft paper pulp was obtained fro the following data sources:

- LCP Directive – 1990 to 2000;
- CELPA – 2003 to 2009 (Kraft paper pulp);
- INE industrial production data – 2003 to 2009 (Acid sulphite paper pulp);
- EU-ETS – 2010 onwards.

Even though different sources were used the ultimate data source was the same: the industrial plants.

Table 3-24: Total Paper Pulp Production (Kraft and sulphide paper pulp)

Product	Unit	1990	2005	2019	2020	2021
Pulp Production	kt	1,398	2,010	2,754	2,679	2,808

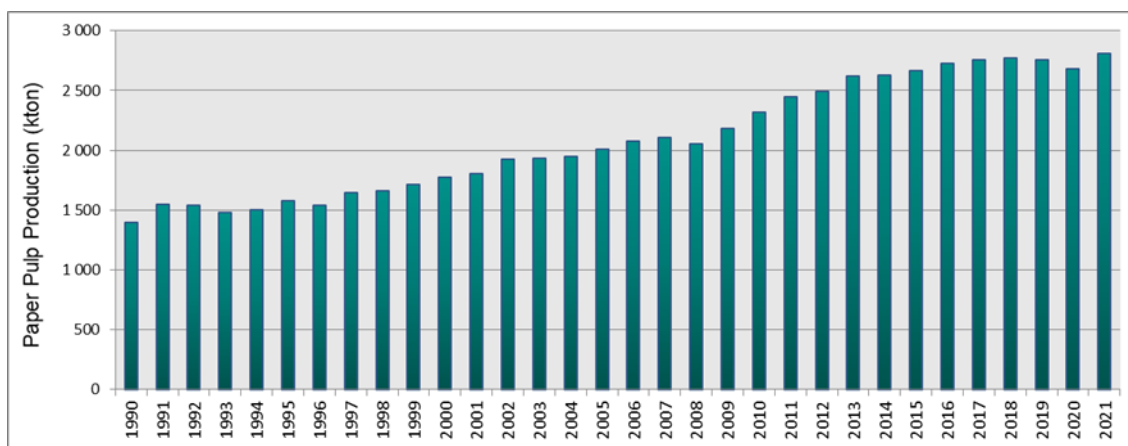

Figure 3-32: Total paper pulp production: Kraft and sulphide paper pulp

Clinker production values cannot be reported due to confidentiality issues.

Data on annual manufacturing of ceramic products is available from 1990 to 2021 from INE statistical database. The time series for total production is shown in Table 3.62 and Figure 3.57, according to type of ceramic.

Table 3-25: Ceramic Production according to type of ceramic (kt)

Product	Unit	1990	2005	2019	2020	2021
Bricks & roof tiles	kt	2,290	3,923	1,815	1,731	1,731
Tiles & other const	kt	478	1,327	927	811	811
Refractory	kt	31	100	19	15	15
Other ceramic	kt	104	278	376	319	319

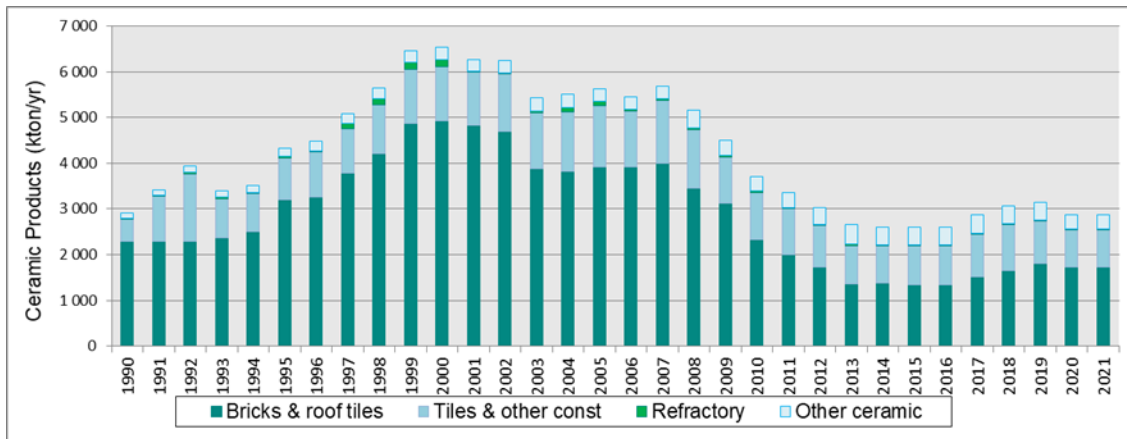

Figure 3-33: Ceramic Production according to type of ceramic

The production values for container glass and lead crystal glass are presented in Figure 3.58 and in Table 3.63, and they were established from the INE statistical databases and information received from Technology Centre for Ceramics and Glass (CTCV). More detailed discussion of the origins of data sources should be consulted in chapter 4.2.A.5. Because of confidentiality concerns the production of flat glass may not be published in NIR.

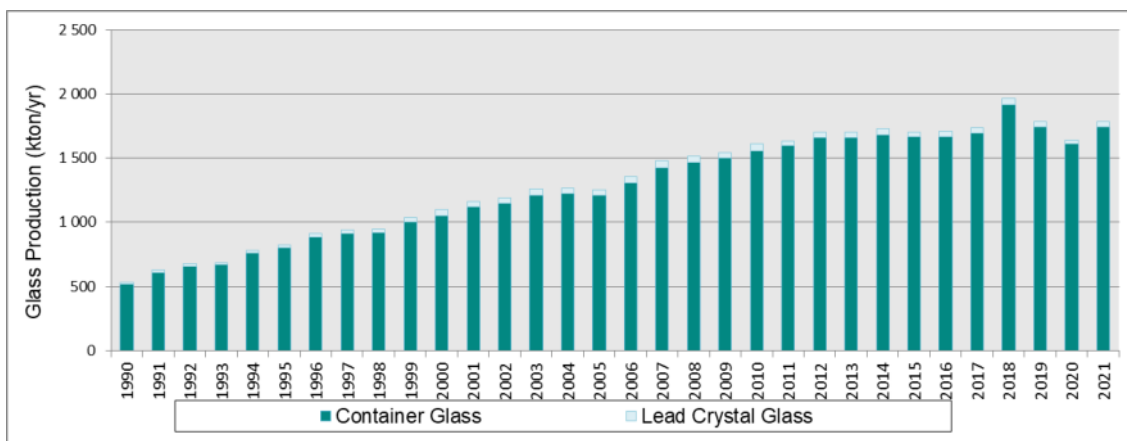

Figure 3-34: Glass production by glass type (excluding flat glass production)

Table 3-26: Glass production by glass type (kt/yr) excluding flat glass production

Product	Unit	1990	2005	2019	2020	2021
Container Glass	kt	508	1,201	1,743	1,615	1,743
Lead Crystal Glass	kt	16	45	43	25	42

Sinter and lime production in iron and steel integrated plan are reported in chapter 2.C.1 – Industrial Processes: Iron and Steel Production.

3.4.3 Emission Factors

The emissions factors that were used are dependent, in the majority of cases, on the fuels characteristics and do not vary with the typology of equipments, except in what concerns the division between fuel use in boilers/furnaces and static engines. It is still not possible to differentiate emission factors for boilers and process furnaces. These emission factors are presented in a separate table where relevant.

In the great majority of cases emission factors were taken from international sources:

- EMEP/CORINAIR Emission Inventory Guidebook - 3rd edition (EEA, 2002);



- EMEP/EEA Air Pollutant Emission Inventory Guidebook – 2009 (EEA, 2009);
- 2006 IPCC Guidelines (IPCC,2006);
- US EPA AP-42 and EIIP (USEPA, 1996; USEPA, 1996b; USEPA, 1998; USEPA, 1998b; USEPA, 1998c).

The set of following tables present the emission factors that were used as default national emission factors in all cases where no specific emission factors may be used, either because there are no specific methodologies and emission factors available in the bibliography or either because country specific emission factors were not developed from national studies and monitoring data. They are presented in the subsequent tables.

The CO₂ emission factors presented in the tables below correspond to values prior multiplication with the corresponding oxidation factor, unless specified otherwise.

Table 3-27: Default emission factors of Greenhouse gases for combustion equipments in Manufacturing Industry

Equipment	Fuel	Code	CO ₂ ⁽ⁱ⁾ (kg/GJ)	Oxidation factor ⁽ⁱ⁾ (ratio)	% C fossil	CH ₄ ⁽ⁱ⁾ (g/GJ)	N ₂ O ⁽ⁱ⁾ (g/GJ)
Boilers	Steam Coal	S 102	98.3	1.00	100	10.0	1.5
	Brown Coal/Lignite	S 105	101.0	1.00	100	10.0	1.5
	Coke from Coal	S 107	94.6	1.00	100	10.0	1.5
	LPG	L 303	63.1	1.00	100	0.9	4.0
	City Gas	G 308	44.4	1.00	100	1.0	0.1
	Coke Oven Gas	S 304	44.4	1.00	100	1.0	0.1
	Blast Furnace Gas	S 305	260.0	1.00	100	1.0	0.1
	Fuel Gas, Hydrogen	G 399	63.1	1.00	100	0.9	4.0
	Biomass Wood	B 111	112.0	1.00	0	11.0	7.0
	Kerosene	L 206	71.9	1.00	100	3.0	0.6
	Diesel Oil	L 204	74.1	1.00	100	3.0	0.6
	Residual Oil	L 203	77.4	1.00	100	3.0	0.6
	Natural Gas	G 301	56.4 ⁽ⁱⁱ⁾	1.00	100	1.0	1.0
	Biodiesel	B 223	70.8	1.00	0	3.0	0.6
Static Engines	Gasoline	L 208	69.3	1.00	100	3.0	0.6
	Gas Oil	L 204	74.1	1.00	100	3.0	0.6
	Biogas	B 309	54.6	1.00	0	1.0	0.1
	Biodiesel	B 223	70.8	1.00	0	3.0	0.6

(i) IPCC (2006); (ii) Country Specific

**Table 3-28: Emission factors of Greenhouse gases in the extractive industry**

Equipment	Fuel		NAPFUE	CO ₂ (kg/GJ)	Oxidation factor (ratio)	% C fossil	CH ₄ (g/GJ)	N ₂ O (g/GJ)
Boilers	LPG	L	303	63.1	1.00	100	1.5	1.4
	Gasoline	L	208	68.6	1.00	100	0.1	0.6
	Kerosene	L	206	71.9	1.00	100	0.6	0.6
	Diesel Oil	L	204	74.1	1.00	100	0.6	0.6
	Residual Oil	L	203	76.6	1.00	100	1.4	0.6
	Natural Gas	G	301	56.4 ⁽ⁱⁱ⁾	1.00	100	1.4	1.4
	Lignite	S	105	101.2	1.00	100	2.4	0.7
Static Engines	Gasoline	L	208	69.3	1.00	100	60	0.6
	Gas Oil	L	204	74.1	1.00	100	60	0.6

(i) IPCC (2006); (ii) Country Specific

Table 3-29: Emission factors for Greenhouse gases in the building and construction industry

Fuel	NAPFUE		LHV	CO ₂	Oxidation Factor	% C fossil	CH ₄ g/GJ	N ₂ O g/GJ
			MJ/kg					
Residual Oil	L	203	40.17	77.4	1.00	100	3.0	0.6
Gas Oil	L	204	43.31	74.1	1.00	100	3.0	0.6
Kerosene	L	206	43.72	71.9	1.00	100	5.0	0.6
Motor Gasoline	L	208	44.77	69.3	1.00	100	9.9	0.6
LPG	L	303	47.28	63.1	1.00	100	1.0	0.1
Natural Gas	G	301	45.97	56.4 ⁽ⁱⁱ⁾	1.00	100	1.0	0.1

(i) IPCC (2006); (ii) Country Specific

Other specific emission factors were used for some industrial units, several of them obtained from direct measurements in LPS or as a result from bibliographic references specific of the industrial sector. Some of the emission factors are used in the process approach and are applied to production data instead of fuel consumption data. These emission factors are listed in the tables below, arranged by sector and indicating if they only apply to LPS.

Table 3-30: Emission factors for use in LPS units in the iron and steel sector

GHG	Fuel							Unit
	Fuel Oil	Coke Oven Gas	Blast Furnace Gas	Coal Tar	Natural Gas	LPG	Diesel	
CO ₂	77.40	44.4	260	80.7	55.56 – 57.43 (1)	63.1	74.1	kg/GJ
CH ₄	3.00	1.00	1.00	1.00	1.00	1.00	3.00	g/GJ
N ₂ O	0.6	0.1	0.1	1.5	0.1	0.1	0.6	g/GJ

Source: Table 2.2 of Chapter 2 of the 2006 IPCC Guidelines

(1) Country specific; EU-ETS

**Table 3-31: Emission factors for use in LPS units in the Chemical Industry: Greenhouse Gases from combustion**

Equipment	Fuel	NAPFUE	CO ₂ (kg/GJ) ⁽ⁱ⁾	Oxidation Factor (ratio)	% C fossil	CH ₄ (g/GJ)	N ₂ O (g/GJ)	
Boilers	Residual Fuel Oil	L	203	77.4	1.00	100	3	0.6
	Pyrolysis Fuel Oil	L	203	77.4	1.00	100	3	0.6
	Fuel Gas	L	307	47.6 – 50.7	1.00	100	1.0	0.1
Furnaces	Fuel Gas	L	307	47.6 – 50.7	1.00	100	1.0	0.1
	Propane	L	303	63.1	1.00	100	1.5	1.4
Static Engines	Residual Fuel Oil	L	203	77.4	1.00	100	3	0.6
	Diesel Oil	L	204	74.1	1.00	100	3	0.6
Flares	Flare Gas	L	307	55.0 – 74.4	1.00	100	1.0	0.1

(i) 2006 IPCC Guidelines

In the 2012 inventory, for the paper and pulp industrial sector, efforts were made to improve the emission estimation by reviewing and update emission factors when possible. To this end new EF data sources were used (EEA, 2009) as well as an in depth revision of the plant specific emission factors for non-direct GHG. The EF used for this industrial sector (LPS estimation only) can be found in the tables below.

Table 3-32: Emission factors used in LPS units in the Paper Pulp Industry: Greenhouse Gases from combustion – Energy Approach

Equipment	Fuel	NAPFUE	CO ₂ ⁽ⁱ⁾		CH ₄ EF (g/GJ)	N ₂ O EF (g/GJ)	
			EF (kg/GJ)	%C fossil			
Auxiliary Boilers	Residual Oil	L	203	77.4	100	3.0	0.6
	Natural Gas	G	301	56.4 ⁽ⁱⁱ⁾	100	1.4	1.4
Biomass Boilers	Wood Waste	B	111	112.0	0	30.0	4.3
	Residual Oil	L	203	77.4	100	3.0	0.6
	Natural Gas	G	301	56.4 ⁽ⁱⁱ⁾	100	1.4	1.4
	LPG	L	303	63.1	100	1.4	1.4
Recovery Boilers	Residual Oil	L	203	77.4	100	3.0	0.6
	Natural Gas	G	301	56.4 ⁽ⁱⁱ⁾	100	-	1.4
	Gas Oil	L	204	74.1	100	-	0.6
	Bisulfite Liquor	B	215	95.3	0	30.0	0.6
	Black Liquor	B	215	95.3	0	-	0.6
	Methanol	B	111	63.1	0	-	1.4
Flare	LPG	L	303	63.1	100	1.4	1.4
Lime Kiln	Gasified Biomass	B	111	112.0	0	-	4.3
	Residual Oil	L	203	77.4	100	-	0.6
	Natural Gas	G	301	56.4 ⁽ⁱⁱ⁾	100	-	1.4
	Gas Oil	L	204	74.1	100	-	0.6
	NCG	B	111	56.4 ⁽ⁱⁱ⁾	0	-	1.4
	Tall-oil	B	111	74.1	0	-	0.6
Static Engine	Gas Oil	L	204	74.1	100	9.9	0.6
Gas Turbine	Natural Gas	G	301	56.4 ⁽ⁱⁱ⁾	100	1.4	1.4

(i) The CO₂ emission factors presented in this table include the corresponding oxidation factor; (ii) Country Specific; NCG- Non-condensable gases

**Table 3-33: Emission factors used in LPS units in the Paper Pulp Industry: Greenhouse Gases from combustion – Production Approach**

Equipment	CH ₄ ⁽ⁱ⁾
	EF (kg/t pulp)
Recovery Boilers	0.23
Lime Kiln	0.029

(i)Source EEA, 2002.

For the cement source, sector emissions were estimated using either activity data as energy consumption (energy approach) or either cement produced (production approach), although both represent similar emissions in cement kiln. Emission factors will not be presented in this report because of confidentiality issues (please see Activity Date chapter for more explanations). Most emission factors result from plant specific emission factors developed from monitoring at each installation, as reported to EPER exercise.

Table 3-34: Greenhouse Gases Emission Factors for ceramic production using the Production Approach: Greenhouse gases

Ceramic	CO ₂ ^(b) (kg/t)	CH ₄ ^(a) (kg/t)
Bricks and roof tiles	0.14	0.029
Tiles & other construction materials	18.57	0.022
Refractory	-	0.029
Other ceramic	-	0.022

Source: (a) 10 % of VOC emissions; (b) EU-ETS

Table 3-35: Emission Factors for glass production using the Production Approach: SO_x and Indirect Precursor gases (kg/t glass)

Type of Glass	SO _x	NO _x	NMVOC	CO
Flat Glass	1.5	4	0.1	0.1
Container Glass	1.7	3.1	4.5	0.1
Lead Crystal Glass	2.8	4.3	4.7	0.1
Other Glass	2.8	4.3	4.7	0.1

Source: USEPA (1986)

Table 3-36: Emission Factors for glass production using the Production Approach: Greenhouse Gases

Type of Glass	CO ₂ kg/t	CH ₄ kg/t
Flat Glass	126	0.01
Container Glass	130	0.45
Lead Crystal Glass	239	0.47
Other Glass	239	0.47

Source: CH₄ USEPA (1986); CO₂ EUTS data

Emission factors for sinter and lime production in iron and steel integrated plan are reported in chapter 4.4.2 of Industrial Processes sector: Iron and Steel Production.

Table 3-37: Greenhouse Gases Emission Factors for Cement Industry using the Energy Approach

Cement Industry	CO ₂ (kg/GJ)	%C Fossil
Tires	85.0	72 %
Industrial Waste	81.4	52 %
Hazardous Industrial Waste	66.2 – 149.0	100 %
Animal + Wood Waste	109.6	0%

**Table 3-38: Greenhouse Gases Emission Factors for Off-road vehicles and other machinery**

Cement Industry	CO ₂ (kg/GJ)	CH ₄ (kg/TJ)	N ₂ O (kg/TJ)	Source
Motor Diesel	74.1	4.2	28.6	Table 3.3.1 – 2006 IPCC GL – Vol.2 Mobile Combustion
Motor Gasoline 4-stroke	69.3	50.0	2.0	Table 3.3.1 – 2006 IPCC GL – Vol.2 Mobile Combustion
Motor Gasoline 2-stroke	69.3	130	0.4	Table 3.3.1 – 2006 IPCC GL – Vol.2 Mobile Combustion

3.4.4 Uncertainty Assessment

Different uncertainty values were attributed to different types of sub-sources considering that different sources of information have diverse error and also assuming that industries for which energy consumption is a more important factor (Energy intensive industries) tend to have and report more accurate data. Consequently, in concordance to what is proposed in IPCC (2000) but always assuming a conservative posture, the following rules were used to establish the uncertainty associated with activity data:

- when fuel consumption was obtained directly from a Large Point Source (LPS) the uncertainty of activity data was set at 3 % for energy intensive industrial sectors (iron and steel, cement, paper pulp, glass and ceramics) and 5 % for all other sources;
- if fuel consumption, other than biomass, results from statistical information gathered from the National Energy balances then uncertainty is 5 % for energy intensive sectors and 10 % for all other sectors;
- the uncertainty in biomass consumption is always higher, at least because the moisture content is always doubtful, and the uncertainty was set in all area sources as 60 %.

The uncertainty of CO₂ emission factors is 5 % for all situations, which is consistent with GPG recommendations. Finally the uncertainty for methane is 150 % and an order of magnitude for N₂O.

3.4.5 Category-specific QA/QC and verification

Similar to 1.A.1.a the majority of the QA/QC procedures were implemented to check consistency between years for the fuel consumption time series of all industrial sectors. Since LHV for several industries show variability between years, a general consistency check was also made.

For industrial sectors where fuel consumption data for individualized plants was available: Paper Pulp, Chemical Manufacturing, Cement Industry and Iron and Steel Plants, a comparison between plant specific data and energy balance fuel consumption was made (see the appropriate chapter for more information).

To further improve the QA/QC analysis, a comparison between fuel consumption values reported by DGEG and IEA (International Energy Agency) was made (please see the chapter Comparison of Energy Balance vs. IEA Energy Statistics). Several differences were identified between data sources for this sector, which may imply problems in the fuel consumption classification for IEA values. Also DGEG reported that there were compilation errors in the information sent to IEA, which may explain the differences found.

3.4.6 Recalculations

In the 2023 submission we identified an occasion where a recalculation had a significant impact on total category 1.A.2 emissions as well as the national total. This recalculation concerns the review of natural gas consumption in the glass industry in 2019. This recalculation meant a reduction in emissions of around 32 kton CO₂eq.



The following recalculations also took place, although with less impact on the category's total emissions:

- 1.A.2.f Glass production: estimation of acetylene combustion emissions for the whole time series;
- 1.A.2.f Cement production: biomass consumption data correction for years 2019-2020;
- 1.A.2.f Lime production: biomass consumption data correction for year 2020.

Table 3-39: Recalculated data for category Manufacturing industries and construction (CRF 1.A.2)

Recalculated data CRF 1A2		Previous submission	Latest submission	Difference	Difference	Impact on total ¹ emissions
Year	GHG's	CO2 eq (kt)			%	
1990	CO ₂	8 854	8 855	0	0.00	0.00
2005	CO ₂	10 406	10 407	0	0.00	0.00
2018	CO ₂	7 476	7 477	0	0.00	0.00
2019	CO ₂	7 708	7 677	-32	-0.41	-0.05
2020	CO ₂	7 465	7 465	0	0.00	0.00
1990	CH ₄	36	36	0	0.00	0.00
2005	CH ₄	54	54	0	0.00	0.00
2018	CH ₄	59	59	0	0.00	0.00
2019	CH ₄	57	57	0	-0.02	0.00
2020	CH ₄	55	55	0	-0.36	0.00
1990	N ₂ O	112	112	0	0.00	0.00
2005	N ₂ O	152	152	0	0.00	0.00
2018	N ₂ O	98	98	0	0.00	0.00
2019	N ₂ O	100	100	0	-0.15	0.00
2020	N ₂ O	101	101	0	-0.08	0.00

(1) Total emissions refer to total aggregate GHG emissions expressed in terms of CO2 equivalent, excluding GHGs from the LULUCF sector.

3.4.7 Further Improvements

For the Manufacturing industries and construction category, the main issues to be improved are:

- Make efforts to develop TIER 2 CO₂ emission factors for liquid fuels, since it is a key category of the Inventory. This is a cross-cutting problem for all categories of the Energy Chapter, and is identified as one of the main priorities in the Methodological Development Plan.
- Increase the amount of information that is collected from the premises, using EU-ETS data preferably, but also through E-PRTR information and other sectoral sources. In particular for the Food, beverages & tobacco (1.A.2.e) and Other Industries (1.A.2.g) subsectors.
- Further investigate the sharp decrease in energy consumption of biomass that occurs between 2011 and 2012, with a particular impact on the ceramic industry.
- Continue to develop the estimates for category 1.A.2.g.vii Off-road vehicles and other machinery. We intend to continue to identify and correctly allocate energy consumption that occurs in the Industry and that originates from mobile sources.
- The updating and improvement of the explanation of the methodology and clarifications present in this chapter of the NIR was identified as a task that allows the improvement of the inventory report. However, it is a time consuming task that we believe will be accomplished through a stepwise approach. It is then expected that the next NIR submissions will contain some changes in content and structure.



3.5 Transport (CRF 1.A.3)

3.5.1 Civil Aviation (CRF 1.A.3.a)

3.5.1.1 Category description

In 2021 emissions from Civil Aviation in Portugal amounted to 2 355 kt CO₂ eq, from which 343 kt CO₂ eq are from domestic flights and 2 012 kt CO₂ eq are from international flights. Emissions from aviation come from the combustion of jet fuel and aviation gasoline. Emissions from combustion in aircraft mobile activities comprehend all air emissions associated with fuel combustion in airplanes, either realized in passenger or freight planes, and either realized during flight or in land activities: idle and taxi. Aircraft operations are divided into:

- Landing/Take-off cycle and;
- Cruise.

Emissions from military aircraft are included in sector 1.A.5.b Other Mobile Sources.

Table 3-40: Estimated emissions from Civil Aviation (kt CO₂ eq).

Source Category/Pollutant	1990	1995	2000	2005	2010	2015	2019	2020	2021
Domestic Aviation	180.23	221.19	322.96	392.78	404.60	369.06	499.95	259.49	343.01
CO ₂	177.82	218.41	319.75	389.14	401.08	365.96	495.79	257.30	340.11
CH ₄	1.10	1.16	0.84	0.75	0.54	0.39	0.48	0.28	0.38
N ₂ O	1.32	1.62	2.37	2.88	2.97	2.71	3.68	1.91	2.52
International Aviation*	1 547.57	1 646.19	2 019.87	2 298.55	2 658.75	3 166.80	4 402.48	1 581.62	2 012.06
CO ₂	1 532.67	1 630.47	2 002.31	2 279.59	2 637.08	3 141.39	4 367.23	1 568.89	1 995.68
CH ₄	3.54	3.63	2.72	2.06	2.12	2.13	2.87	1.10	1.59
N ₂ O	11.36	12.09	14.84	16.90	19.55	23.29	32.37	11.63	14.79

*Memo item. Emissions not included in national totals.

For the elaboration of the greenhouse gases emissions inventory which is reported to the EU¹⁷ and to the UNFCCC, emissions from flights to and from the autonomous regions of Azores and Madeira islands are included in national totals.

Emissions of domestic and international flights must be reported separately to UNFCCC. In order to strictly follow UNFCCC good practice the separation is done according to the following table.

Table 3-41: IPCC 2006 source categories.

Source Category	Coverage
1 A 3 a Domestic Aviation	Emissions from civil domestic passenger and freight traffic that departs and arrives in the same country (commercial, private, agriculture, etc.), including take-offs and landings for these flight stages.
1 D 1 International Aviation (International Bunkers)	Emissions from flights that depart in one country and arrive in a different country. Include take-offs and landings for these flight stages.
1 A 5 b Mobile (aviation component)	Emissions from military aviation.

¹⁷ Decision 2004/280/CE



3.5.1.2 Methodology

The methodology that is used in the inventory to estimate emissions from jet fuel is a Tier 3 according with 2019 EMEP/EEA Guidebook (see figure below). This method uses data from individual flights with information on the origin and destination, aircraft type, engines type, and date of the flight. This method provides a good accurate separation between domestic and international flights.

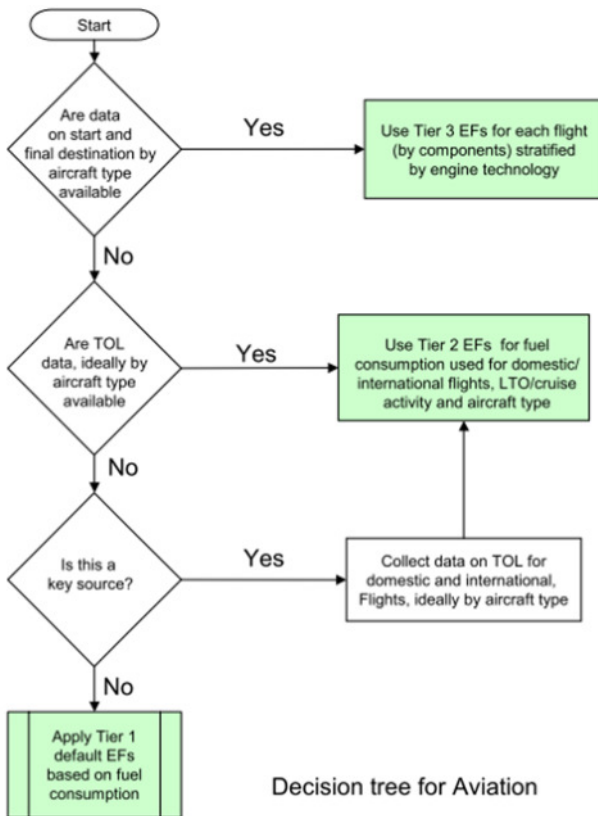

Figure 3-35: Decision tree for emissions from aviation (EMEP/EEA, 2019)

The method to estimate emissions from aviation gasoline is a Tier 1 according with IPCC 2006 which is based primarily in energy statistics.

The choice of methods allows the harmonization between inventories covering greenhouse gas emissions and inventories covering other air pollutants.

Emissions are calculated separately for:

- Landing and Take-off Cycle emissions (LTO_{Cycle}). Emissions from activities realized near airport in the ground and on flight under an altitude of 3000 feet (914 m): idle, taxi-in, taxi-out, take-off, climbing and descending;
- Cruise emissions. All emissions realized above 3000 feet, including ascend and descend between cruise altitude and 3000 feet;
- Fuel type: jet fuel and aviation gasoline. Jet fuel is used mostly in large commercial aircraft. Aviation gasoline is used in piston engine aircrafts;
- Origin and destination of the flight;
- Movement type: arrival and departure;
- Aircraft type.



3.5.1.2.1 Landing/Take-off Cycle

The general approach to estimate emissions during LTO_{Cycle} is:

$$\begin{aligned} Emission_{LTO(p,d,a,s,y)} &= Emission_{Arriva(p,d,a,s,y)} + Emission_{Departur(p,d,a,s,y)} \\ Emission_{Arriva(p,d,a,s,y)} &= N_{Arriva(d,a,s,y)} \times EF_{Arriva(p,s)} \times 10^{-3} \\ Emission_{Departur(p,d,a,s,y)} &= N_{Departur(d,a,s,y)} \times EF_{Departur(p,s)} \times 10^{-3} \end{aligned}$$

Where:

$Emission_{LTO(p,d,a,s,y)}$ – Emissions of pollutant p from origin/destiny d in airport a performed by aircraft s during year y (t/yr);

$Emission_{Arriva(p,d,a,s,y)}$, $Emission_{Departur(p,d,a,s,y)}$ – Arrival and departure emissions of pollutant p from, respectively, origin and destiny d in airport a performed by aircraft s during year y (t/yr);

N_{Arriva} , $N_{Departur}$ – Number of arrival and departure movements performed in year y, by aircraft s in airport a from origin/destiny d;

$EF_{Arriva(p,s)}$ – Sum of approach and taxi-in emission factor for pollutant p and aircraft s (kg/movement);

$EF_{Departur(p,s)}$ – Sum of taxi-out, take-off and climb emission factor for pollutant p and aircraft s (kg/movement);

p – pollutant;

d – origin/destination;

a – airport;

s – aircraft;

y – year.

However, the aircraft type is not always available. For these cases the approach is based on an airport specific emission factor as follows:

$$\begin{aligned} Emission_{LTO(p,d,a,y)} &= Emission_{Arriva(p,d,s,y)} + Emission_{Departur(p,d,a,y)} \\ Emission_{Arriva(p,d,a,y)} &= N_{Arriva(d,a,y)} \times EF_{Arriva(p,a)} \times 10^{-3} \\ Emission_{Departur(p,d,a,y)} &= N_{Departur(d,a,y)} \times EF_{Departur(p,a)} \times 10^{-3} \end{aligned}$$

The next figure outlines the process whereby LTO_{Cycle} emissions are estimated.

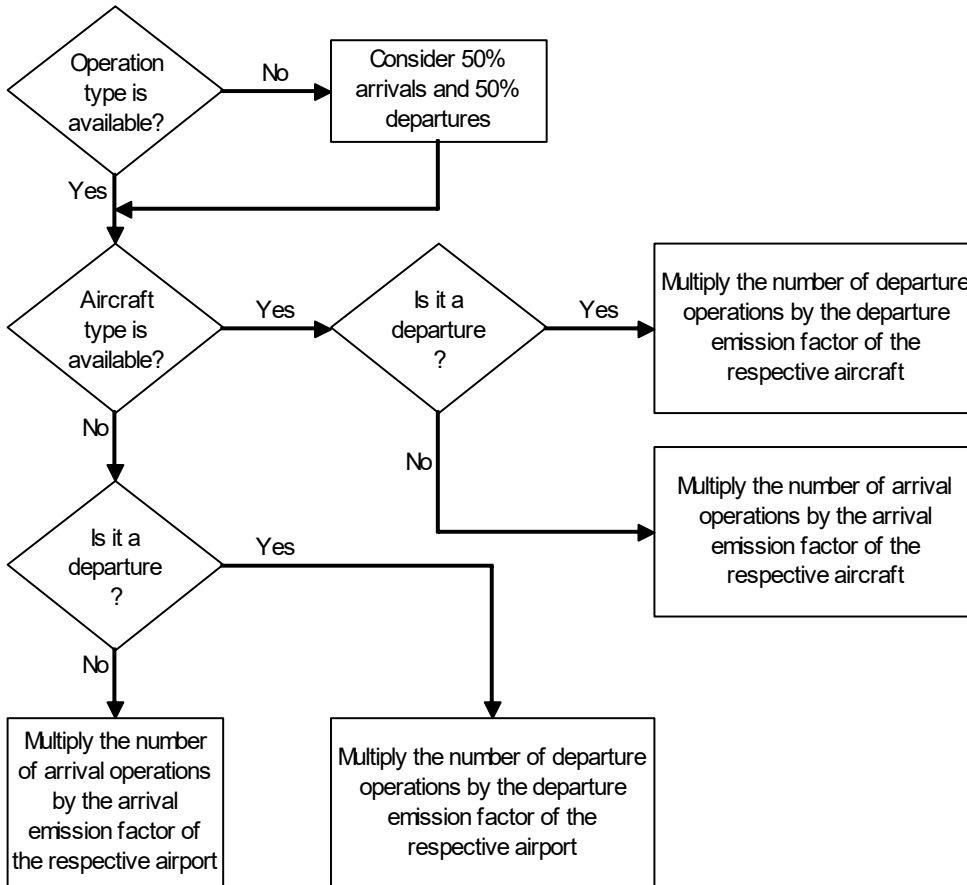

Figure 3-36: Decision tree for LTOCycle emission calculation.

3.5.1.2.2 Cruise

Domestic cruise emissions are estimated based on aircraft movement data. The approach relies on a origin and destination matrix. The distances between airports are calculated from an airport coordinates database (Partow, 2003) applied to a great circle distance algorithm (GCD) assuming the Earth as a perfect sphere. Emission factors are given for each aircraft type and for a specific flight distance. International cruise emissions are estimated from fuel consumption. The international fuel consumption is estimated by subtracting the LTO_{Cycle} and the domestic cruise fuel from the total fuel sales.

$$Emission_{cruise(p,d,a,s,y)} = N_{LTO(d,a,s,y)} \times EF_{cruise(p,d,s,t,y)} \times 10^{-3}$$

Where:

$Emission_{cruise(p,d,a,s,y)}$ – Domestic cruise emissions of pollutant p resulting from flight with origin/destiny d in airport a performed by aircraft s during year y (t/yr);

$N_{LTO(d,a,s,y)}$ – number domestic LTO_{Cycle} from origin/destiny d in airport a performed by aircraft type s during year y;

$EF_{cruise(p,d,a,s,t,y)}$ – Emission factor for pollutant p specific for flight with origin/destination d taking time t performed by aircraft type s in year y (kg/LTO).

In national airports the same national flight is registered in origin airport as a departure and in destiny airport as an arrival therefore the number of national movements must be divided by two to avoid double counting.



3.5.1.3 Emission Factors

3.5.1.3.1 LTO

3.5.1.3.1.1 Aircraft Based LTO Emission Factors

Emissions factors for LTO were set for each aircraft type according to information from ICAO Emission Factor Databank which contains emission factors for each operation condition: idle, take off, climb out and approach conditions. Emissions factors for arrival and departure were then set from the default time in mode proposed by FAEEED table and from the emission factor for each operation condition where:

Departure includes taxi-out (idle), take off and climb out modes;

Arrival includes approach and taxi in (idle) conditions.

Table 3-42: Emissions factors for most common aircraft movements in national airports.

Aircraft	Take-off (kg/movement)					Land (kg/movement)				
	FC	HC	CO	NOx	PM	FC	HC	CO	NOx	PM
Airbus A318/319/320/321	674.7	1.8	15.6	26.5	6.3	273.0	0.7	6.1	4.7	3.0
Airbus A320-100/200	674.7	1.8	15.6	26.5	6.3	273.0	0.7	6.1	4.7	3.0
Airbus A319	546.4	0.8	8.7	15.1	5.1	224.6	0.3	3.7	2.9	2.4
British Aerospace ATP	813.2	1.4	15.5	27.3	7.6	354.5	0.6	6.6	5.7	3.9
Boeing 737 all pax models	685.2	4.4	16.3	13.4	6.3	287.4	1.9	7.8	2.9	3.1
Fokker 100	481.0	1.9	12.4	9.5	4.4	202.8	0.8	5.3	1.7	2.1
Shorts SD.360	63.9	8.7	10.0	0.5	0.6	34.1	4.0	4.9	0.2	0.4
Embraer RJ135 / RJ140 / RJ145	232.5	0.8	5.3	4.9	2.2	105.2	0.4	2.4	1.2	1.1
Airbus A321-100/200	674.7	1.8	15.6	26.5	6.3	273.0	0.7	6.1	4.7	3.0
Embraer RJ145 Amazon	232.5	0.8	5.3	4.9	2.2	105.2	0.4	2.4	1.2	1.1
Boeing 757 all pax models	804.2	1.4	15.5	27.3	7.5	328.7	0.6	6.5	5.2	3.6
Boeing 737-800 (winglets) pax	581.4	1.3	11.3	16.7	5.4	243.2	0.5	4.7	3.9	2.6
Airbus A310-200 Freighter	996.1	4.7	20.7	37.3	9.4	421.2	1.9	8.9	6.9	4.7
Airbus A310 all pax models	1136.9	1.3	9.0	50.1	10.5	499.0	0.5	3.8	8.0	5.4
Cessna 172 Mescalero	2.5	0.1	2.2	0.0	0.0	1.4	0.0	1.5	0.0	0.0
Boeing 757 Mixed Configuration	804.2	1.4	15.5	27.3	7.5	328.7	0.6	6.5	5.2	3.6
Fairchild Dornier Do.228	111.3	5.4	14.7	2.3	1.0	54.2	2.4	7.7	0.6	0.6
Boeing 737-300 Freighter	548.5	1.2	18.4	11.3	5.1	235.0	0.5	7.6	3.1	2.5
McDonnell Douglas MD80	656.6	2.7	9.3	16.5	6.1	281.9	1.5	4.6	3.8	3.0
Beechcraft 1900/1900C/1900D	131.6	16.2	16.2	1.5	1.2	60.5	6.8	8.7	0.4	0.6
Boeing 737-700 (winglets) pax	505.6	1.5	12.1	12.1	4.7	215.5	0.5	5.2	3.2	2.3
CASA / IPTN 212 Aviocar	378.0	4.2	14.2	11.0	3.5	171.1	1.9	7.0	2.3	1.9
Boeing 737-500 pax	548.5	1.2	18.4	11.3	5.1	235.0	0.5	7.6	3.1	2.5
Beechcraft 1900/1900C	131.6	16.2	16.2	1.5	1.2	60.5	6.8	8.7	0.4	0.6
Aerospatiale Fennec (AS-550)	94.1	1.5	3.4	1.3	1.0	94.1	1.5	3.4	1.3	1.1
Dassault (Breguet Mystere) Falcon	42.2	0.4	2.0	0.9	0.4	34.1	0.4	2.4	0.3	0.3
Airbus A340 all models	1376.4	11.8	74.4	106.1	12.8	557.3	4.4	28.6	18.2	6.1
Boeing 767 all pax models	996.1	4.7	20.7	37.3	9.4	421.2	1.9	8.9	6.9	4.7
Mooney M-20	3.0	0.1	3.1	0.0	0.0	2.1	0.0	2.5	0.0	0.0



3.5.1.3.1.2 Airport Based LTO Emission Factors

Specific airport LTO emission factors were needed for movements where information about the aircraft type was not available. Therefore weighted averaged departure and arrival emission factors were estimated from the fleet composition for each airport and year. This set of averaged airport based LTO emission factors, was used mainly in movements from 1990 to 1999 since this was the period for which information on aircraft characteristics was scarce.

Table 3-43: Airport based LTO emission factors (kg/movement).

Airport	Operation	Parameter	1990	1995	2000	2005	2010	2015	2019	2020	2021
Lisboa (LIS)	Take-off	Fuel Consumption	670.2	608.9	567.4	452.6	451.6	468.4	471.9	453.3	368.4
		VOC	16.4	14.9	15.2	9.3	2.8	2.3	2.3	2.5	2.0
		CO	37.1	33.7	35.4	21.5	13.8	12.8	13.2	13.7	10.0
		NOx	26.3	23.9	23.6	16.2	15.9	17.1	17.0	16.1	12.0
		PM ₁₀	6.2	5.6	5.2	4.2	4.2	4.4	4.4	4.2	3.4
	Landing	Fuel Consumption	291.0	264.4	240.2	204.2	206.6	223.7	207.0	194.7	165.3
		VOC	7.0	6.4	6.0	4.4	1.5	1.2	1.2	1.3	1.1
		CO	17.8	16.2	16.3	11.1	7.0	6.5	6.4	6.4	5.2
		NOx	4.9	4.4	4.3	3.3	3.4	3.8	3.5	3.3	2.6
		PM ₁₀	3.1	2.8	2.6	2.2	2.2	2.4	2.2	2.1	1.8
Porto (OPO)	Take-off	Fuel Consumption	530.0	481.5	401.1	374.4	427.6	358.1	354.3	374.0	301.1
		VOC	8.2	7.5	6.5	4.1	3.3	2.6	2.2	2.2	2.1
		CO	26.3	23.9	23.0	13.7	12.8	10.7	10.7	11.2	9.1
		NOx	19.1	17.3	15.0	11.9	14.7	11.9	11.9	12.5	9.2
		PM ₁₀	4.9	4.5	3.7	3.5	4.0	3.3	3.3	3.5	2.8
	Landing	Fuel Consumption	236.2	214.6	181.3	172.9	191.7	171.1	162.5	170.8	138.3
		VOC	3.7	3.3	2.9	2.2	1.6	1.4	1.3	1.3	1.3
		CO	12.7	11.5	11.1	7.2	6.3	5.8	5.7	6.0	5.1
		NOx	3.8	3.5	3.0	2.6	3.2	2.8	2.7	2.9	2.1
		PM ₁₀	2.5	2.3	1.9	1.9	2.1	1.8	1.7	1.8	1.5
Faro (FAO)	Take-off	Fuel Consumption	514.8	467.7	443.6	348.7	339.1	263.5	265.6	245.8	208.9
		VOC	5.3	4.8	4.9	3.0	2.4	2.1	2.0	2.1	2.1
		CO	19.2	17.4	17.2	12.2	11.0	8.5	8.4	8.0	7.4
		NOx	17.4	15.8	16.0	11.0	10.0	7.7	7.6	7.2	5.8
		PM ₁₀	4.8	4.3	4.1	3.2	3.1	2.4	2.5	2.3	1.9
	Landing	Fuel Consumption	231.8	210.6	198.9	158.2	161.1	139.3	130.1	119.1	100.7
		VOC	2.7	2.5	2.5	1.7	1.4	1.4	1.3	1.5	1.5
		CO	10.0	9.1	9.0	6.5	5.9	5.0	4.8	4.8	4.6
		NOx	3.5	3.2	3.1	2.3	2.4	2.0	1.8	1.7	1.4
		PM ₁₀	2.5	2.3	2.1	1.7	1.7	1.5	1.4	1.3	1.1

3.5.1.3.2 Cruise Emissions

3.5.1.3.2.1 Aircraft Based Cruise Emissions

Cruise emissions were estimated from EMEP/CORINAIR detailed methodology. Cruise emissions are given for typical cruise distances (see EMEP/CORINAIR Emission Inventory Guidebook, December 2001: ppB851-22, Table 8.4; Annex 1; Annex 2). This information was used to derive emissions for specific distances according with a trend line established between discrete samples provided in the EMEP/CORINAIR Emission Inventory Guidebook



The table below shows an example of cruise emission for Airbus and Boeing models.

Table 3-44: Cruise emissions and fuel consumption.

Aircraft	Distance (km)	Fuel Consumption (kg)	NOX (kg)	HC (g)	CO (g)
Airbus A310 all pax models	0	0	0	0	0
	232	1 270	30	290	1587
	463	2 359	49	490	2651
	926	4 450	64	763	3848
	1389	6 541	89	1026	4913
	1852	8 632	113	1288	5977
	2778	12 992	166	1836	8193
	3704	17 441	214	2378	10345
	4630	22 159	273	2960	12678
	5556	27 135	340	3585	15206
6482	32 223	408	4223	17790	
Airbus A318/319/320/321	0	0	0	0	0
	232	842	17	149	1096
	463	1 695	27	267	1742
	926	2 858	45	508	3108
	1389	3 903	56	684	3571
	1852	5 225	73	915	4688
	2778	7 530	99	1311	6166
	3704	10 064	130	1747	7849
	4630	12 639	159	2189	9532
Boeing 727 all pax models	0	0	0	0	0
	231.5	1303.9	11	907	3459
	463	2341.8	17	2206	5869
	926	4247.3	43	2311	8837
	1389	6080.4	58	3072	11842
	1852	8058.3	74	3746	14568
	2778	12131.4	108	5279	20688
	3704	16459.4	147	6871	27075
4630	20825.2	185	8477	33515	

Source: EMEP/CORINAIR

3.5.1.3.2.2 Airport Based Cruise Emissions

Averaged airport cruise emission factors were needed for movements where information about the aircraft type was not available. For this purpose, weighted averaged cruise emission factors were estimated from the fleet profile in each airport, year and origin/destination.

Again, this set of averaged airport based cruise emissions, were used mainly in movements from 1990 to 1999 since this was the period for which information on aircraft characteristics was scarce.

3.5.1.3.3 Correspondence between aircraft type and representative aircraft

The availability of emissions factor is limited to a certain number of engines and frames. Therefore a representative aircraft is needed when an emission factor is not available for a specific airplane. Annex B shows the correspondence between aircrafts and representative aircrafts for LTO and cruise emissions factors.



3.5.1.3.4 Fuel dependent emission factors

Fuel dependent emission factors were set for CO₂ and N₂O. Emission factors for CO₂ and N₂O are IPCC default. The LHV were obtained from the national energy authority (DGEG).

Table 3-45: Fuel dependent emission factors

Pollutant	Aviation Gasoline	Jet Fuel
LHV (MJ/kg)	44.0	43.0
CO ₂ (t/TJ)	70	71.5
N ₂ O (kg/TJ)	2.00	2.00

Source: IPCC 2006; DGEG

3.5.1.4 Activity Data

3.5.1.4.1 Flight movements in Airports

Very important activity data for this source activity is the number of arrival and departure movements. The number of movements by airport, aircraft, origin/destiny and movement type (arrival or departure) for the period between 1990 and 2021 was provided by the *Autoridade Nacional da Aviação Civil* (ANAC). This database is being improved and the coverage of it is increasing as new airports (mostly regional and local airports) are connected to the movements' database from ANAC.

Table 3-46: LTO_{Cycle} per airport.

Region	Airport Code	1990	1995	2000	2005	2010	2015	2019	2020	2021
Mainland	LIS	30 862	34 932	56 073	68 168	73 783	84 385	112 367	45 980	51 600
	OPO	11 574	13 348	23 280	25 910	28 502	35 248	49 753	22 317	21 426
	FAO	11 252	13 067	18 243	20 397	22 359	22 330	31 510	12 560	14 902
	TOTAL	53 688	61 347	97 596	114 475	124 643	141 963	193 629	80 856	87 927

Region	Airport Code	1990	1995	2000	2005	2010	2015	2019	2020	2021
Islands	FNC	6 475	9 460	12 040	15 952	12 697	12 442	13 031	6 180	10 563
	TER	3 801	4 049	4 501	4 875	4 988	4 755	6 031	3 819	4 221
	PDL	2 954	3 382	4 134	7 196	8 182	8 499	12 712	8 111	4 318
	PXO	2 403	4 243	3 788	3 688	2 325	2 103	1 708	1 093	2 854
	HOR	1 237	1 542	1 756	2 964	2 919	2 331	2 940	2 107	1 799
	SMA	634	893	1 557	1 649	1 275	1 073	1 561	1 203	639
	FLW	281	357	552	1 101	1 136	1 002	1 524	1 104	477
	TOTAL	17 785	23 924	28 327	37 425	33 521	32 204	39 505	23 616	24 870

Source: ANAC

Data concerning aircraft operation characteristics, particularly, the origin/destiny, the aircraft type and the movement type was sometimes not included in the records database. The worst case refers to the period between 1990 and 1994, for this period the only information available was the number of operations, all other information was missing. There is also the period between 1995 and 1999 with missing data on aircraft type. For all these cases an alternative approach had to be set.

An alternative database was however available with information on the number of operations and the aircraft types. This data was very useful to determine the aircraft fleet profile in each airport between 1990 and 1999 whereby airport representative arrival and departure emission factors were determined.

On the other hand, for records with missing information on origin and destiny, a yearly fraction of international, domestic and European flights was derived for each airport relying on the movements which had this information. This was necessary to differentiate emissions between domestic and international.

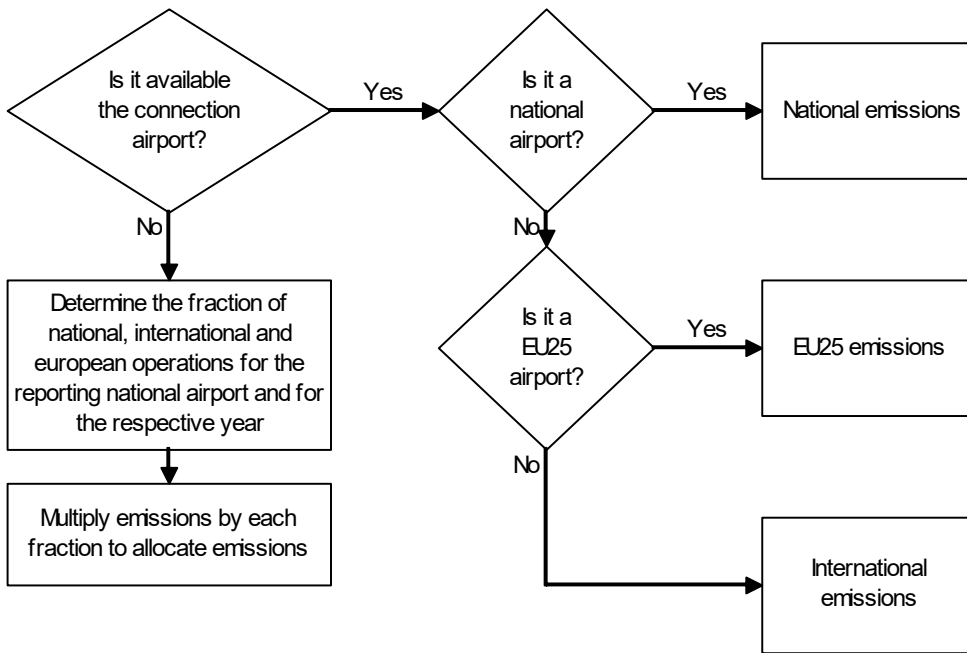
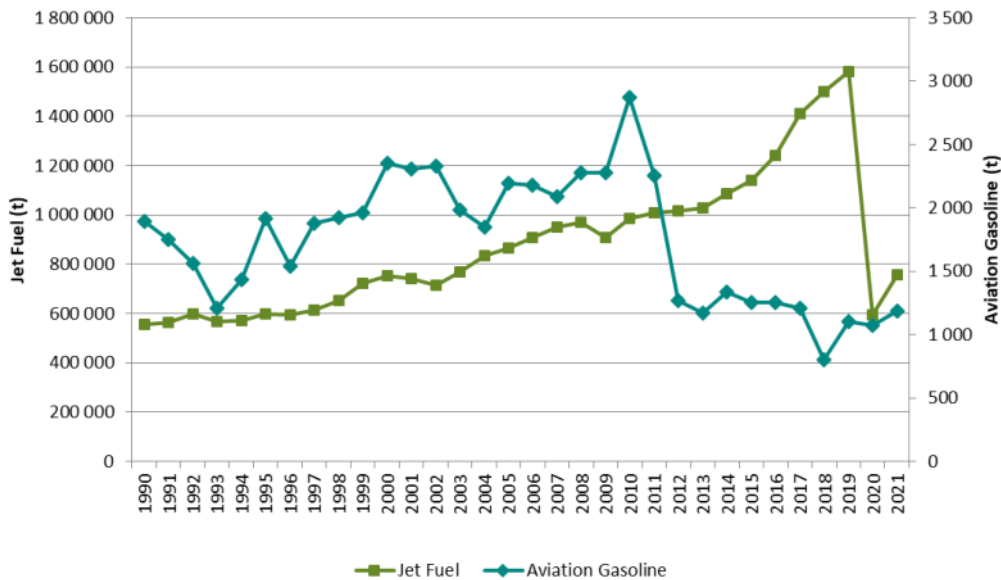

Figure 3-37: Decision tree for distinction between domestic and international emissions.

3.5.1.4.2 Fuel Consumption

Fuel consumption is available from fuel sales statistics from DGEG for main territory and islands. LTO_{Cycle} and domestic cruise fuel consumption is estimated with a bottom-up approach. International cruise consumption is estimated as the difference to the total fuel sales. This approach guarantees that the total fuel for aviation equals the fuel sales.



Source: DGEG

Figure 3-38: Total Fuel consumption of aviation gasoline and jet fuel (Source: DGEG).



3.5.1.5 Uncertainty Assessment

Activity level refers to the fuel domestic consumption which was estimated for LTO and Cruise separately according with the following couple equations.

$$U_{cruise} = \sqrt{U_{movements}^2 + U_{time}^2 + U_{FCcruise}^2}$$

$$U_{lto} = \sqrt{U_{movements}^2 + U_{FClto}^2}$$

The activity level uncertainty (U_{global}) is therefore obtained from:

$$U_{global} = \frac{\sqrt{(E_{cruise} \times U_{cruise})^2 + (E_{lto} \times U_{lto})^2}}{E_{cruise} + E_{lto}}$$

Where:

E_{cruise} , E_{lto} = domestic energy consumption under cruise and LTO (GJ).

Table 3-47: Aviation activity level uncertainty.

Source	Parameter	Unit	1990	1995	2000	2005	2010	2015	2017	2019	2020	2021
All	U_{global}	%	71	72	35	36	35	35	34	34	34	36
Cruise	U_{cruise}	%	99	99	47	49	48	47	45	45	46	48
LTO	U_{lto}	%	100	100	48	49	48	47	46	45	45	46

The uncertainties of emissions factors were set at 5% for CO₂, 100% for methane and one order of magnitude for N₂O, following the recommendations from GPG.

3.5.1.6 Category-specific QA/QC and verification

Energy consumption was compared with data from the energy balance reported by DGEG. No differences were found between total fuel estimated with the described methodology and total fuel reported in the energy balance.

3.5.1.7 Recalculations

No recalculations were made.

3.5.1.8 Further Improvements

No further improvements are planned for this sector.



3.5.2 Road Transportation (CRF 1.A.3.b)

3.5.2.1 Category description

Road Transportation is one of the most important emitter of greenhouse gases (GHG) such as carbon dioxide (CO₂), methane (CH₄) and nitrous oxide (N₂O).

Exhaust greenhouse gases emissions from Road Transportation were estimated at about 15 334 Kt CO₂ eq in 2021, representing an increase of 51% when compared to 10,179 Kt CO₂ eq estimated for 1990.

Emissions of N₂O have almost doubled since 1990 due to the introduction of catalytic converters. This emissions increased by a factor of 4.6 between 1990 and 2000 and have since then been slowly diminishing to less than half that record value. The introduction of catalytic converters have some disadvantages including the increase of CO₂ and NH₃ emissions which contribute to climate change and acid deposition. It is difficult to assess the extent to which CO₂ emissions have increased as a result of fitting catalytic converters, because improvements in fuel economy have been made at the same time as development of the engine management systems that are required to minimize NO_x and VOC emissions.

Table 3-48: Estimated emissions from Road Transportation (Kt CO₂ eq).

Source Category/Pollutant	1990	1995	2000	2005	2010	2015	2019	2020	2021
1A3b - CO ₂ Fossil	10 000.59	13 261.92	18 629.75	19 013.95	18 102.17	15 523.36	16 766.27	14 193.92	15 174.67
1A3b - CO ₂ Biomass*	0.00	0.00	0.00	0.00	859.02	899.84	768.37	689.24	971.22
1A3b - CH ₄	108.80	113.88	97.82	67.38	43.76	28.39	23.84	19.17	20.51
1A3b - N ₂ O	69.85	169.18	323.63	171.18	140.48	130.87	146.09	126.71	138.83
1A3b - Road Transportation	10 179.25	13 544.98	19 051.20	19 252.52	18 286.40	15 682.62	16 936.21	14 339.80	15 334.01
2D1 - Lubricants in 4-stroke	20.75	25.87	33.62	34.41	35.49	31.55	33.66	28.56	30.87
2D3c - Urea	0.00	0.00	0.00	0.00	3.13	5.73	9.76	8.96	10.30

*Information item. Emissions not included in national totals.

Exhaust emissions from Road Transportation include emission from the combustion of lubricant use in two-stroke engines, which represent, in 2021, 0.01% of the total exhaust emissions from Road Transportation.

Greenhouse gases emissions from Road Transportation also include non-combustive CO₂ emissions from the use of urea-based additives in catalytic converters (reported under 2D3c) and from lubricants that enter accidentally in the four-stroke engines combustion chambers (reported in 2D1). In 2021, these emissions represented respectively 0.07% and 0.2% of the total emissions from Road Transportation.

3.5.2.2 Methodology

Emissions from Road Transportation are estimated using the COPERT 5¹⁸ (Version 5.4.36 - October 2020) and includes the following type of emissions:

- Exhaust Emissions from Fuel (1A3bi, 1A3bii, 1A3biii, 1A3iv) - CO₂¹⁹, CH₄ and N₂O;
- Exhaust Emissions from Lubricants use in two-stroke engines (1A3iv) – CO₂;
- Emissions from Lubricants use in four-stroke engines (2D1) – CO₂
- Urea based catalytic converters emissions - SCR (Selective Catalytic reduction) (2D3c) – CO₂.

¹⁸ <https://www.emisia.com/utilities/copert/>

¹⁹ Exhaust emissions from fuels include estimation of the CO₂ emissions from the fossil part of biofuels.



For the calculation of these emissions, beyond COPERT 5 emission factors, several National Activity Data and Input Variables are used:

- Environmental Information (Temperature, Humidity)
- Trip Characteristics (Trip length, Trip duration)
- Fuel Characteristics and Specifications
- Energy Consumption
- Vehicle Fleet
- Distance travelled (Mean Activity - Km)
- Circulation Data (Average Speed, Mileage % per driving mode)

An additional tool was developed by APA to calculate the vehicle fleet and distance travelled with information from vehicle inspection centers, sales and abatements.

The energy consumption is provided by the national energy authority. To ensure that the statistical energy consumption match the calculated energy consumption, COPERT 5 adjust the blend type and share and the annual distance travelled (mean activity).

Estimated emissions from Road Transportation are based in Tier 1 method for CO₂ emissions and Tier 3 for non-CO₂ emissions.

3.5.2.3 Emission Factors

Emissions factors for Exhaust Emissions and non-combustive CO₂ emissions from the use of urea-based additives in catalytic converters were determined using COPERT 5.

3.5.2.3.1 Implied Emission Factors

Distance Implied Emission Factors were calculated for Vehicle Category and Fuel and are presented in the next table.

Table 3-49: Road Transportation distance based implied emission factor for 2021 (g/km and mg/km).

Category	Fuel	CO ₂ fossil	CH ₄	N ₂ O
		g/km	mg/km	mg/km
Passenger Cars	Petrol	202.11	27.95	3.76
Passenger Cars	Petrol Hybrid	140.90	19.92	2.00
Passenger Cars	Diesel	192.46	1.19	7.15
Passenger Cars	LPG Bifuel	191.90	34.40	0.00
Light Commercial Vehicles	Petrol	260.23	84.44	8.95
Light Commercial Vehicles	Diesel	229.80	2.87	6.30
Heavy Duty Trucks	Diesel	559.58	19.19	24.86
Buses	Diesel	1 198.86	41.27	21.46
Buses	CNG	1 339.89	998.83	1 000.00
L-Category - Mopeds	Petrol	70.89	116.21	1.00
L-Category - Motorcycles	Petrol	127.49	54.11	2.00

More detailed Implied Emission Factors based on distance (g/km and mg/km) and different Vehicle Category, Fuel, Segment and Euro Standard, for 2021, are presented in Annex B.

The Implied Emission Factors based on energy (t/TJ), for 2021, were determined for different Vehicle Category, Fuel, Segment and Euro Standard and are also presented in Annex B.



3.5.2.4 Activity Data and Input Variables

3.5.2.4.1 Environmental information

The **monthly average ambient minimum and maximum temperatures** and **monthly average relative air humidity** were inputted into COPERT 5. The temperature data was received from 15 climatological stations of the *Portuguese Sea and Atmosphere Institute* (IPMA) and concerns a long period average from 1971 to 2000. The humidity information is related to modeled historical data from 1971 to 2000. The same values were used for all years in analysis.

Table 3-50: Monthly average ambient temperatures (°C) and relative air humidity (%).

Month	Minimum Temperature	Maximum Temperature	Relative Humidity
January	4.5	13.1	85
February	5.6	14.6	82
March	6.8	17.0	79
April	8.1	18.2	76
May	10.5	21.0	72
June	13.5	25.4	65
July	15.6	28.7	57
August	15.5	28.8	56
September	14.2	26.3	63
October	11.2	21.2	76
November	7.9	16.8	83
December	6.1	13.9	85

Source: (<http://portaldoclima.pt/en/>)

3.5.2.4.2 Trip Characteristics

According to COPERT 5 methodology some country properties related with trip characteristics are necessary. For Portugal the average **trip length** considered was 10 km (as described in the EMEP/EEA Guidebook 2019, table 3.35) while the average **trip duration** is 12 minutes.

3.5.2.4.3 Fuel Characteristics and Specifications

Some fuel specifications used, like energy content, density, H:C and O:C ratio, were default COPERT 5 values set accordingly with EMEP/EEA Guidebook 2019.

Table 3-51: Fuel specifications.

Fuel	Energy Content (Mj/kg)	Density (kg/m ³)	H:C Ratio	O:C Ratio
Petrol	43.77	750.00	1.86	0.00
Diesel	42.70	840.00	1.86	0.00
LPG	46.56	520.00	2.53	0.00
CNG	48.00	175.00	4.00	0.00
Biodiesel	37.30	890.00	1.95	0.11
Bioethanol	28.80	794.00	3.00	0.50

The **Sulphur content** in Petrol and Diesel was set in line with National Legislation values. For LPG, CNG, Biodiesel and Bioethanol it was assumed a 0% Sulphur content.



Table 3-52: Sulphur content in petrol and diesel (ppm wt).

Fuel	1990-1999
Leaded Petrol	1000

Fuel	1990-1995	1996-2001	2002-2004	2005-2008	2008-2021
Unleaded Petrol	1000	500	150	50	10

Fuel	1990-1994	1995	1996-2000	2001-2004	2005-2008	2009-2021
Diesel	3000	2000	500	350	50	10

Source: National Legislation (Portaria n.º124/89, Portaria n.º125/89, Portaria 949/94, Portaria n.º1489/95, Decreto-Lei nº 104/2000, Decreto-Lei nº 235/2004, Decreto-Lei nº 142/2010 e Decreto-Lei nº 214-E/2015).

Monthly values of fuel volatility (RVP - Reid Vapour Pressure) were established from Portuguese Legislation.

Table 3-53: Reid Vapour Pressure (kPa).

Month	1990 to 1995	1996 to 1999	2000 to 2021
January	98	95	90
February	98	95	90
March	98	95	90
April	83	80	90
May	83	80	60
June	70	70	60
July	70	70	60
August	70	70	60
September	70	70	60
October	83	95	90
November	98	95	90
December	98	95	90

3.5.2.4.4 Energy Consumption

Fuel consumption from Road Transportation sector is available from the Energy Balances from DGEG while the lubricant consumption is calculated by COPERT 5. Fuel and lubricant consumption is presented in the following figure and Annex B.

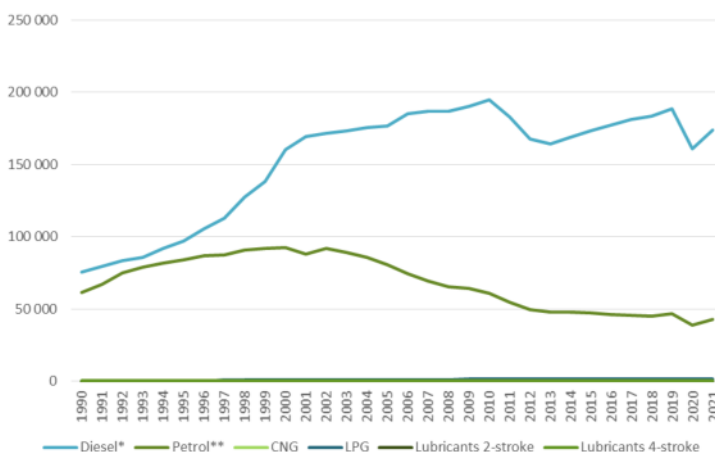

* includes incorporation of Biodiesel
 ** includes incorporation of Bioethanol

Figure 3-39: Fuel and lubricant consumption from Road Transportation sector (TJ).



In addition to the “10.05.04 Road Transport” category of the Energy Balance the Road Transportation sector also consider petrol from “10.4 services” category and part of diesel from “10.01.01 Agriculture” category as described in 3.6 Other Sectors (1A4).

Lubricant consumption that contributes to exhaust emission in Road Transportation includes lubricant consumed as energy in two-stroke engines.

Emission from lubricants used in vehicle engines to reduce friction and cool components that are not combusted and emissions from lubricant that enters accidentally in the four-stroke engines combustion chambers are included in section related to Lubricants Use (CRF 2.D.1).

In Portugal the incorporation of Biodiesel in Diesel starts in 2006 and the incorporation of Bioethanol in Petrol starts in 2012. The incorporation rates in the Road Transportation Sector are presented in the next tables.

Table 3-54: Incorporation rate of Biodiesel in Diesel (%).

2006	2007	2008	2009	2010	2011	2012	2013
1.31%	2.50%	2.43%	4.16%	6.03%	6.25%	6.20%	6.05%
2014	2015	2016	2017	2018	2019	2020	2021
5.93%	6.81%	5.15%	5.10%	5.48%	5.41%	5.73%	7.33%

Source: DGEG

Table 3-55: Incorporation rate of Bioethanol in Petrol (%)

2012	2013	2014	2015	2016	2017	2018	2019	2020	2021
0.09%	0.16%	0.16%	1.73%	1.89%	0.28%	0.56%	0.77%	0.74%	1.58%

Source: (DGEG)

3.5.2.4.5 Vehicle Fleet

The active fleet of Passenger Cars, Light Commercial Vehicles, Heavy Duty Trucks and Buses, for the period between 2003 and 2021, was obtained from data from the national vehicle inspection centres from *Instituto da Mobilidade e dos Transportes* (IMT) complemented with data on vehicle sales from *Associação Automóvel de Portugal* (ACAP).

For the period between 1990 and 2002, due to the absence of information from the inspections centers, to determine the active fleet per year for Passenger Cars, Light Commercial Vehicles, Heavy Duty Trucks and Buses was applied a function that considers the vehicle survival rates. The backcasting for the estimation of the active fleet, for the period between 1990 and 2002, was estimated taking into account the survival rates of the data from the national vehicle inspection centers, between 2003 and 2016, and the vehicle fleet for 2003 for the different vehicle and fuel categories.

Despite the different splicing techniques to resolve data gaps presented in the 2006 IPCC Guidelines Volume I, we considered that due to the fact that technical conditions changes throughout the time series and that the backcast was not applied directly to the emission estimation but to one of the activity data considered, was necessary to develop this customised approach for the vehicle fleet estimation for the period between 1990 and 2003.

The number of mopeds and motorcycles was obtained from insurance data from *Autoridade de Supervisão de Seguros e Fundos de Pensões* (ASF) since these vehicles are excluded from the vehicle inspection programme. The classification by type of segment and age was possible with data from *Instituto da Mobilidade e dos Transportes* (IMT) and *Associação Automóvel de Portugal* (ACAP).

The application of COPERT 5 vehicle segment to the data from vehicle inspection centers was based on *Associação Automóvel de Portugal* (ACAP) segmentation data considering weight and/or cylinder power ranges.



Table 3-56: COPERT 5 segments.

COPERT 5 Vehicle Category	COPERT 5 Vehicle Segment	Fuel	Weight (kg)	Cylinder Power (cm ³)
Passenger Cars	Mini	Petrol	< 1 400	< 1 000
	Small	Petrol Hibrid	< 1 800	< 1 600
	Medium	Diesel	< 2400	< 1 900
	Large-SUV-Executive	LPG Bifuel	> 2400	> 1 900
Light Commercial Vehicles	N1-I	Petrol	< 1 900	-
	N1-II	Diesel	1 900 - 2 600	-
	N1-III		> 2 600	-
Heavy Duty Trucks	Rigid <=7,5 t	Diesel	<= 7 500	-
	Rigid 7,5 - 12 t		7 500 - 12 000	-
	Rigid 12 - 14 t		12 000 - 14 000	-
	Rigid 14 - 20 t		14 000 - 20 000	-
	Rigid 20 - 26 t		20 000 - 26 000	-
	Rigid 26 - 28 t		26 000 - 28 000	-
	Rigid 28 - 32 t		28 000 - 32 000	-
	Rigid >32 t		> 32 000	-
	Articulated 14 - 20 t		< 20 000	-
	Articulated 20 - 28 t		20 000 - 28 000	-
	Articulated 28 - 34 t		28 000 - 34 000	-
	Articulated 34 - 40 t		34 000 - 40 000	-
	Articulated 40 - 50 t		40 000 - 50 000	-
Articulated 50 - 60 t	> 50 000	-		
Buses	Urban Buses Midi <=15 t	Diesel	<= 15 000	-
	Urban Buses Standard 15 - 18 t		15 000 - 18 000	-
	Urban Buses Articulated >18 t		> 18 000	-
	Coaches Standard <=18 t		<= 18 000	-
	Coaches Articulated >18 t		> 18 000	-
	Urban CNG Buses	CNG	-	-
L-Category	Mopeds 2-stroke <50 cm ³	Petrol	-	<50
	Mopeds 4-stroke <50 cm ³		-	<50
	Motorcycles 2-stroke >50 cm ³		-	>50
	Motorcycles 4-stroke <250 cm ³		-	<250
	Motorcycles 4-stroke 250 - 750 cm ³		-	250 - 750
	Motorcycles 4-stroke >750 cm ³		-	>750

Vehicle technology was determined according with European and National legislation and the vehicle first registry year as presented in table below.



Table 3-57: Technology classification according to first registry year.

Vehicle Category	Fuel	Euro Standard	First Registry year	
			from	to
Passenger Cars	Petrol	PRE ECE	...	1971
		ECE 15/00-01	1972	1977
		ECE 15/02	1978	1980
		ECE 15/03	1981	1985
		ECE 15/04	1986	1992
		Euro 1	1993	1996
		Euro 2	1997	2000
	Petrol / Petrol Hybrid	Euro 3	2001	2005
		Euro 4	2006	2010
		Euro 5	2011	2014
		Euro 6 a/b/c	2015	2018
		Euro 6 d-temp	2019	2020
	Diesel	Euro 6 d	2021	...
		Conventional	...	1992
		Euro 1	1993	1996
		Euro 2	1997	2000
		Euro 3	2001	2005
		Euro 4	2006	2010
		Euro 5	2011	2014
		Euro 6 a/b/c	2015	2018
	LPG Bifuel	Euro 6 d-temp	2019	2020
		Euro 6 d	2021	...
		Conventional	...	1992
		Euro 1	1993	1996
		Euro 2	1997	2000
		Euro 3	2001	2005
		Euro 4	2006	2010
		Euro 5	2011	2014
Light Commercial Vehicles - N1-I	Petrol	Euro 6 a/b/c	2015	2016
		Euro 6 d-temp	2017	2019
		Euro 6 d	2020	...
		Conventional	...	1994
		Euro 1	1995	1997
		Euro 2	1998	2000
		Euro 3	2001	2005
		Euro 4	2006	2010
	Diesel	Euro 5	2011	2015
		Euro 6 a/b/c	2016	2017
		Euro 6 d-temp	2018	2020
		Euro 6 d	2021	...
		Conventional	...	1994
		Euro 1	1995	1997
		Euro 2	1998	2000
Light Commercial Vehicles - N1-II/N1-III	Petrol	Euro 3	2001	2005
		Euro 4	2006	2010
		Euro 5	2011	2014
Light Commercial Vehicles - N1-II/N1-III	Petrol	Euro 6 a/b/c	2015	2017
		Euro 6 d-temp	2018	2020
		Euro 6 d	2021	...
Light Commercial Vehicles - N1-II/N1-III	Petrol	Conventional	...	1994
		Euro 1	1995	1998
		Euro 2	1999	2001



Vehicle Category	Fuel	Euro Standard	First Registry year	
			from	to
		Euro 3	2002	2006
		Euro 4	2007	2011
		Euro 5	2012	2015
		Euro 6 a/b/c	2016	2017
		Euro 6 d-temp	2018	2020
		Euro 6 d	2021	...
	Diesel	Conventional	...	1994
		Euro 1	1995	1998
		Euro 2	1999	2001
		Euro 3	2002	2006
		Euro 4	2007	2011
		Euro 5	2012	2014
		Euro 6 a/b/c	2015	2017
		Euro 6 d-temp	2018	2020
Euro 6 d	2021	...		
Heavy Duty Trucks and Buses	Diesel	Conventional	...	1993
		Euro I	1994	1996
		Euro II	1997	2001
		Euro III	2002	2006
		Euro IV	2007	2009
		Euro V	2010	2013
		Euro VI A/B/C	2014	2018
Euro VI D/E	2019	...		
Buses	CNG	Euro I	1994	1996
		Euro II	1997	2001
		Euro III	2002	2006
		EEV	2007	...
Mopeds	Petrol	Conventional	...	2000
		Euro 1	2001	2002
		Euro 2	2003	2006
		Euro 3	2007	2017
		Euro 4	2018	2020
		Euro 5	2021	...
Motorcycles	Petrol	Conventional	...	2000
		Euro 1	2001	2003
		Euro 2	2004	2006
		Euro 3	2007	2016
		Euro 4	2017	2020
		Euro 5	2021	...

The following table shows the vehicle fleet by vehicle category.

Table 3-58: Vehicle fleet synthesis.

Vehicle Category	1990	1995	2000	2005	2010	2015	2019	2020	2021
Passenger Cars	1 552 912	2 516 415	3 546 152	3 962 031	4 386 247	4 611 618	5 145 775	5 013 948	5 123 312
Light Commercial Vehicles	290 461	591 823	960 124	1 177 894	1 255 037	1 210 303	1 220 937	1 207 539	1 237 528
Heavy Duty Trucks	52 054	79 076	108 924	115 517	107 452	93 413	102 631	102 826	107 436
Buses	6 209	8 405	11 946	13 851	14 666	14 255	15 357	14 464	14 391
L-Category	900 822	774 282	673 994	487 589	497 024	527 431	660 662	691 537	726 390
Total	2 802 458	3 970 001	5 301 140	5 756 882	6 260 426	6 457 020	7 145 362	7 030 314	7 209 057

Detailed information, regarding vehicle fleet, with information of Vehicle Category, Fuel, Segment and Euro Standard is presented in Annex B.

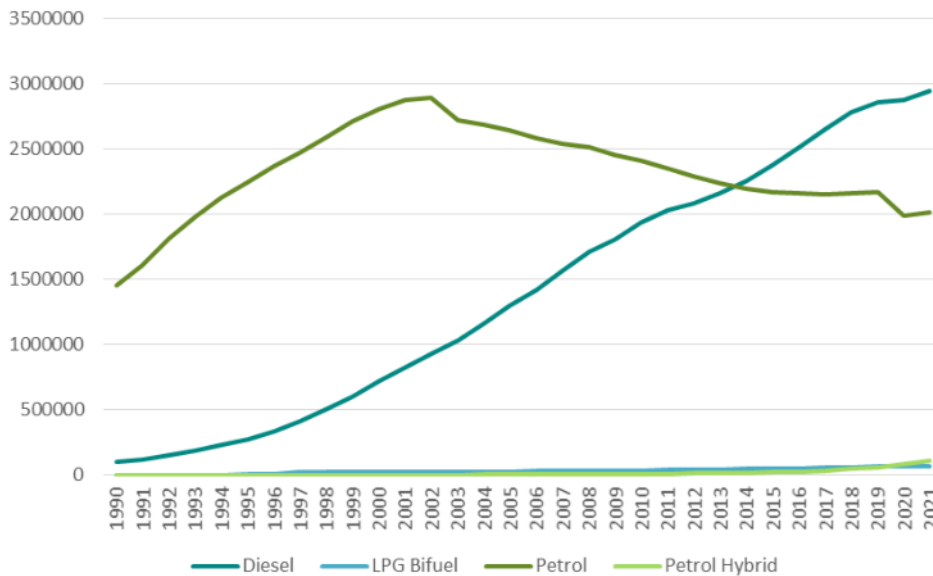

Figure 3-40: Number of Passenger Cars by fuel type.

The number of gasoline passenger cars has decreased over the last years. It was observed a decrease in the number of this type of vehicles while diesel passenger cars have increased. After an initial growth, LPG fuelled vehicles have stabilized as a small percentage of passenger cars.

3.5.2.4.6 Distances Travelled

Distance travelled for each year for Passenger Cars, Light Commercial Vehicles, Heavy Duty Trucks and Buses was established using a model based on data from vehicle inspection centers. This model uses the total number of km made by each vehicle segment, taking into account the first registration date, and estimates the total kilometers traveled in a year, dividing the total km of a given vehicle by its age. For the period between 2003 and 2021 the total mileage figures are obtained directly from the inspection centers, while for the period from 1990 to 2002 a backcast method is used to estimate the km made by different vehicle category taking into account its age. This approach, although more complex and detailed, can be considered a trend extrapolation as defined in point 5.3.3.4. of Section 5.3 "Resolving Data Gaps" in Volume 1: General Guidance and Reporting Guidelines of the IPCC 2006 Guidelines In addition, an adjustment is made to the km traveled by each vehicle taking into account the national fuel sales reported in the energy balance, using an approach similar to that described in point 5.3.3.2 Surrogate Data.

For Mopeds and Motorcycles the average distance travelled was obtained by the TRACCS Project (<http://traccs.emisia.com/index.php>).

Total road traffic activity has increased 86% between 1990 and 2021.

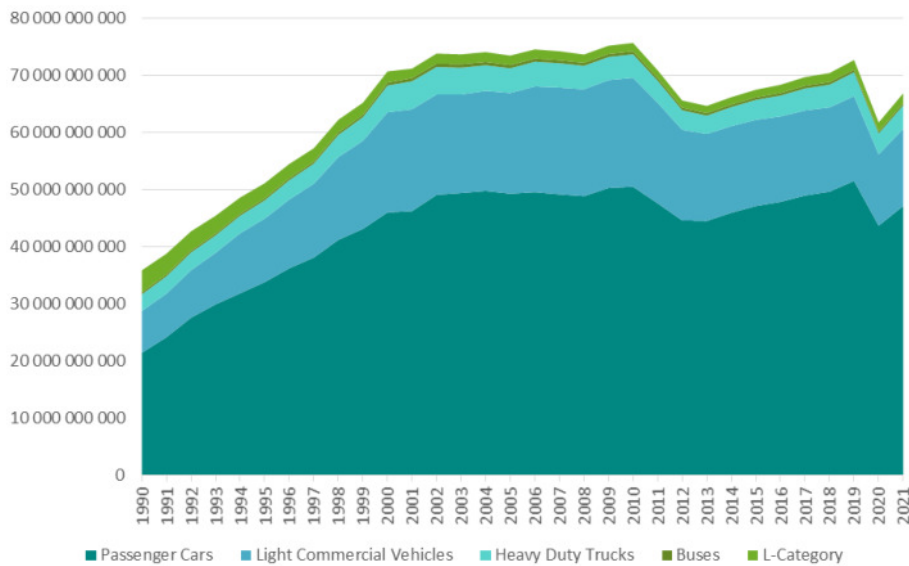

Figure 3-41: Kilometers travelled by vehicle type (vkm).

Detailed information on total activity, for the period between 1990 and 2021, regarding different Vehicle Categories, Fuel types, Segments and Euro Standard is presented in Annex B.

3.5.2.4.7 Circulation data

Three driving modes were individualized: urban, rural and highway.

The distance travelled were allocated to the driving modes. Information on Vehicle-kilometers (vkm) driven under highways derives from the *Instituto da Mobilidade e dos Transportes* (IMT) which is the technical regulator for mobility and transport. Originally this data is communicated to IMT by the highway service providers. The remaining vkm are allocated to urban and rural driving modes according with the population living in each area.

**Table 3-59: Assumed mileage percentage driven by driving mode and vehicle type for 2021.**

Driving Mode	Vehicle Type	Assumed share
Highway	Passenger Car	30.09%
	Light Duty Vehicles	30.09%
	Heavy Duty Vehicles	47.13%
	Urban Buses	0.00%
	Coaches	47.13%
	Mopeds	0.00%
	Motorcycles	30.09%
Rural	Passenger Car	24.32%
	Light Duty Vehicles	24.32%
	Heavy Duty Vehicles	18.39%
	Urban Buses	0.00%
	Coaches	52.87%
	Mopeds	34.79%
	Motorcycles	24.32%
Urban	Passenger Car	45.59%
	Light Duty Vehicles	45.59%
	Heavy Duty Vehicles	34.47%
	Urban Buses	100.00%
	Coaches	0.00%
	Mopeds	65.21%
	Motorcycles	45.59%

For each driving mode average speeds had to be set by vehicle type whereas vehicle fuel consumption and exhaust emissions are strongly dependent on speed.

Table 3-60: Assumed vehicle speeds by driving mode and vehicle type.

Driving Mode	Vehicle Type	Assumed Speed (km/h)	Source
Highway	Passenger Car	124	Lemonde, 2000
	Light Duty Vehicles	124	Lemonde, 2000
	Heavy Duty Vehicles	103	LNEC, 2002
	Coaches	103	LNEC, 2002
	Motorcycles	124	Lemonde, 2000
Rural	Passenger Car	61	LNEC, 2002
	Light Duty Vehicles	61	LNEC, 2002
	Heavy Duty Vehicles	56	LNEC, 2002
	Coaches	56	LNEC, 2002
	Mopeds	40	Maximum Legal Value
	Motorcycles	61	LNEC, 2002
Urban	Passenger Car	24.9	Gois et al., 2005
	Light Duty Vehicles	24.9	Gois et al., 2005
	Heavy Duty Vehicles	24.9	Gois et al., 2005
	Buses	14.8	Carris, 2005
	Coaches	24.9	Gois et al., 2005
	Mopeds	24.9	Gois et al., 2005
	Motorcycles	24.9	Gois et al., 2005



3.5.2.5 Uncertainty Assessment

In accordance with the chapter of Road Vehicles in the GPG, the uncertainty of methane emission factor is 40% and the uncertainty for nitrous oxide should be at least 50%. The uncertainty in CO₂ is 5%, also in accordance with the same source of information. The uncertainty of activity data was assumed to be 5%.

3.5.2.6 Category-specific QA/QC and verification

Energy consumption data from the Energy Balance reported by DGEG, the Total Fuel Sales imported to COPERT and the Total Fuel Consumption exported from COPERT were compared and no significant differences were found.

3.5.2.7 Recalculations

The major changes between submissions result from the update of activity data, namely:

- Revision of the stock and distances travelled data from 1994 to 2020;
- Revision of the incorporation rates of biofuels in 2017, 2019 and 2020;
- Revision of the share of FAME in Biodiesel and ETBE in Bioethanol in 2020;
- Revision of the 2014, 2015, 2016, 2019 and 2020 Energy Balances data provided by DGEG.

3.5.2.8 Further Improvements

Continue with the efforts to develop country-specific parameters for gasoline and diesel oil in order to follow the UNFCCC recommendations.

We are planning to update the latest version of COPERT in a future submission.



3.5.3 Railways (CRF 1.A.3.c)

3.5.3.1 Category description

Although there has been a growing electrification of railway lines in Portugal during latest years, locomotives, shunting locomotives and railcars are still responsible for substantial part of rail transport and consequent emission of GHG in exhaust.

Table 3-61: Estimated emissions from Railways (Gg CO₂e).

Source Category/Pollutant	1990	2005	2019	2020	2021
Railways	197.8	91.9	32.1	32.6	28.8
CO ₂	177.2	82.3	29.1	25.7	25.5
CH ₄	0.3	0.1	0.0	0.0	0.0
N ₂ O	18.1	8.4	3.1	2.8	2.8

*Information item. Emissions not included in national totals.

3.5.3.2 Methodology

Emissions to atmosphere of ultimate CO₂ from fossil origin were estimated from CO₂ total emissions by:

$$\text{Fossil}_{\text{CO}_2(\text{y})} = \sum_f [\text{EF}_{\text{CO}_2(\text{f})} * \text{Fac}_{\text{OX}(\text{f})} * \text{C}_{\text{Fossil}(\text{f})} * \text{Cons}_{\text{Fuel}(\text{f},\text{y})} * \text{LHV}_{(\text{f})}] * 10^{-5}$$

Where:

Fossil_{CO₂(y)} - Emissions of carbon dioxide to atmosphere from combustion of fossil fuel f (t);

EF_{CO₂(f)} – Total carbon content of fuel expressed in total CO₂ emissions (kgCO₂/GJ);

C_{Fossil} - Percentage of carbon from fossil origin in fuel f (%);

Fac_{OX(f)} – Oxidation factor for fuel f (ratio 0..1);

Cons_{Fuel(f,y)} - Consumption of fuel f in year y (t/yr);

LHV_(f) - Low Heating Value (MJ/kg).

For all other pollutants the following formula was used:

$$\text{Emission}_{(\text{p},\text{y})} = \sum_f [\text{EF}_{(\text{f},\text{p})} * \text{Cons}_{\text{Fuel}(\text{f},\text{y})}] * 10^{-3}$$

Where:

Emission_(p,y) - Emission of pollutant p in year y (t/yr);

EF_(f,p) - Quantity of pollutant p emitted from fuel f (kg/t);

Cons_{Fuel(n,f,y)} - consumption of fuel f during in year y (t/yr).

3.5.3.3 Emission Factors

Emission factors were set from available proposed emission factors in IPCC 2006 Guidelines.

Table 3-62: Low Heating Value (LHV) – Railways.

Fuel	Fuel type	Low Heating Value	
		Value	Unit
Sub-bituminous Coal	S	24.66	MJ/kg
Coaking Coal	S	30.81	MJ/kg
Diesel-oil	L	43.00	MJ/kg
Biodiesel	B	37.00	MJ/kg

Source: DGEG



Table 3-63: Oxidation factor and Percentage of carbon from fossil origin in fuels – Railways.

Fuel	Oxidation Factor		% C Fossil	
	Value	Unit	Value	Unit
Sub-bituminous Coal	1.00	MJ/kg	100	%
Coaking Coal	1.00	MJ/kg	100	%
Diesel-oil	1.00	MJ/kg	100	%
Biodiesel	1.00	MJ/kg	100	%

Table 3-64: Emission factors for Greenhouse gases in Railways.

Fuel	CO ₂ EF		CH ₄ EF		N ₂ O EF	
	Value	Unit	Value	Unit	Value	Unit
Sub-bituminous Coal	96.1	kg/GJ	0.002	kg/GJ	0.002	kg/GJ
Coaking Coal	96.1	kg/GJ	0.002	kg/GJ	0.002	kg/GJ
Diesel-oil	74.1	kg/GJ	0.004	kg/GJ	0.028	kg/GJ
Biodiesel	70.8	kg/GJ	0.004	kg/GJ	0.028	kg/GJ

Source: 2006 IPCC Guidelines - Volume 2: Energy - 1A Mobile Combustion (Table 3.4.1)

3.5.3.4 Activity Data

Consumption of fuel in the railway transport sector is available by fuel type from 1990 to 2020 from the energy balance. Besides some very small use of coal and coke until 1996, the majority of combustible energy refers to use of gas oil²⁰. The quantities that were consumed have been decreasing steadily since 1992 due to electrification of the power lines, as can be seen in the next Figure.

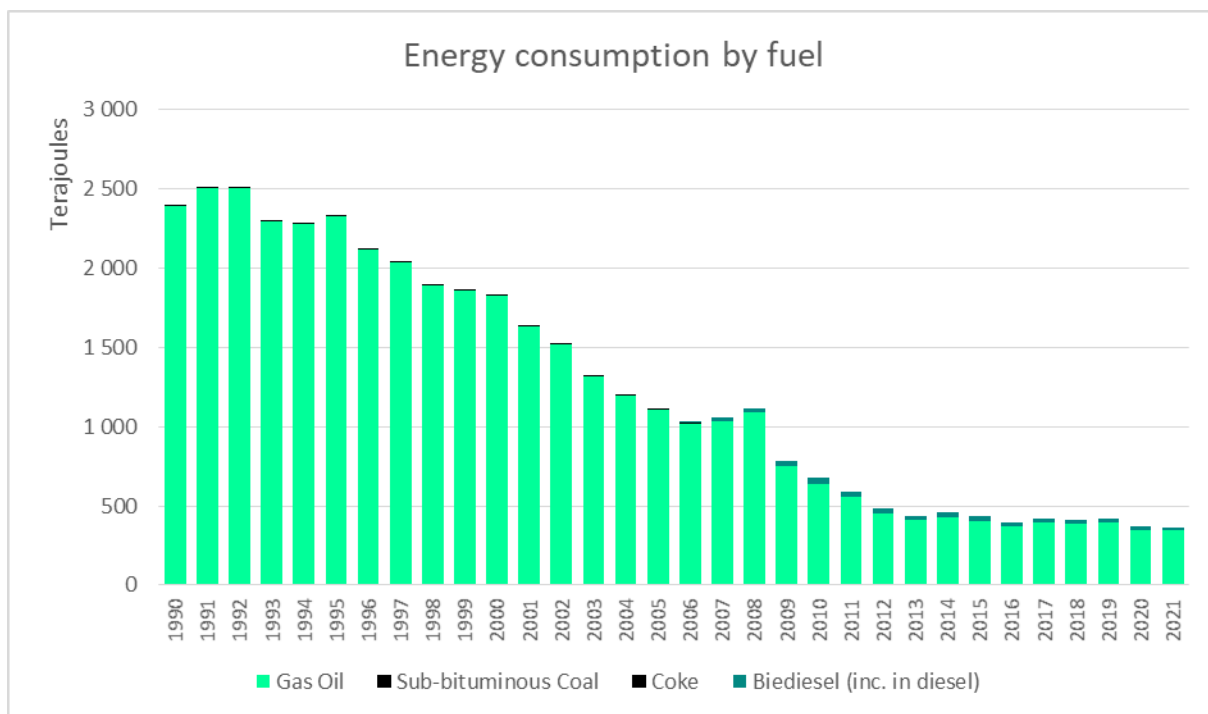

Figure 3-42: Consumption of fuels in the railway transport sector.

Between 1990 and 1997, there was a decrease in the consumption of coal in rail transport that accompanies a process of electrification of the rail network. The abrupt increase since 1998 is explained by a Locomotive that operated only for tourist purposes between 1998 and 2012 on the Douro Line. The consumption of this locomotive would be of the order of 1.5 tons of coal per trip, having taken about 20 trips/year, so Portugal assumed a consumption of 20 toe/year for the activity of this vehicle.

²⁰ Gas oil represents no less than 93 % of total annual use of combustible energy.



As of 2006, the diesel consumed by rail transport has incorporated biodiesel, similarly to what happens with road transport, however this diesel is colored and marked and the supply is made directly at some railway stations with their own tanks. Below is the annual import rate considered for the period between 2006 and 2020.

Table 3-65: Incorporation rate of biodiesel (% toe/toe)

	2006	2007	2008	2009	2010	2011	2012	2013
Incorporation rate	1.31	2.50	2.43	4.16	6.03	6.25	6.20	6.05
	2014	2015	2016	2017	2018	2019	2020	2021
Incorporation rate	5.93	6.81	5.15	5.10	5.48	5.41	5.56	5.56

3.5.3.5 Uncertainty Assessment

The uncertainty of fuel consumption was set equal to the uncertainty that was also considered for road traffic: 5 %. In a similar way the uncertainties in methane and nitrous oxide emission factors were set at 40 % and 50 % respectively, the same values that were used for road traffic. The general error of 5 %, set for most combustion sources, was used for the calculation of uncertainties of carbon dioxide emissions.

3.5.3.6 Category-specific QA/QC and verification

General revision of time series consistency for fuel consumption and emission factors was the only QA/QC procedure adopted for this sector.

3.5.3.7 Recalculations

No recalculations

3.5.3.8 Further Improvements

No further improvements are planned for this sector.



3.5.4 Water-Borne Navigation (CRF 1.A.3.d)

3.5.4.1 Category description

This sector refers to domestic ship transport between Portuguese ports including traffic to the Azores and Madeira islands.

Table 3-66: Estimated emissions from Water-Borne Navigation (kt CO₂e).

Source Category/Pollutant	1990	1995	2000	2005	2010	2015	2019	2020	2021
Domestic Water-Borne Navigation	265.0	229.4	203.3	211.2	231.3	285.5	272.3	203.5	209.1
CO ₂	262.5	227.3	201.4	209.2	229.1	282.8	269.7	201.6	207.1
CH ₄	0.7	0.6	0.5	0.5	0.6	0.7	0.7	0.5	0.5
N ₂ O	1.8	1.6	1.4	1.5	1.6	2.0	1.9	1.4	1.4
International Water-Borne Navigation*	1 413.2	1 129.4	1 682.8	1 567.8	1 650.0	2 042.8	3 097.3	2 213.2	2 167.7
CO ₂	1 400.0	1 118.8	1 667.0	1 553.1	1 634.5	2 023.7	3 068.3	2 192.5	2 147.4
CH ₄	3.6	2.9	4.3	4.0	4.2	5.2	7.8	5.6	5.5
N ₂ O	9.7	7.8	11.5	10.7	11.3	14.0	21.2	15.2	14.9

*Memo item. Emissions not included in national totals

For recreational craft, since it is not possible to separate consumption in the Energy Balance, we consider that emissions may also be included in Road Transport (1.A.3.b) and National Fishing (1.A.4.c.iii).

3.5.4.2 Methodology

The methodology used for the calculation of emissions from shipping activities is in accordance with the ship movement methodology from the detailed methodology of EMEP/CORINAR air pollutant emission inventory guidebook (version from August 2002). This methodology takes into account ship movement data, fuel used as well as the type of ship, the distance travelled and the speed of vessel. Therefore, according with IPCC Guidelines, this approach consists in a detailed method (tier 2 or 3). Since fuel consumption is used for top-down calibration, tier 2 method could be regarded as the method used to estimate emissions from shipping activities.

The general approach could be described as follows:

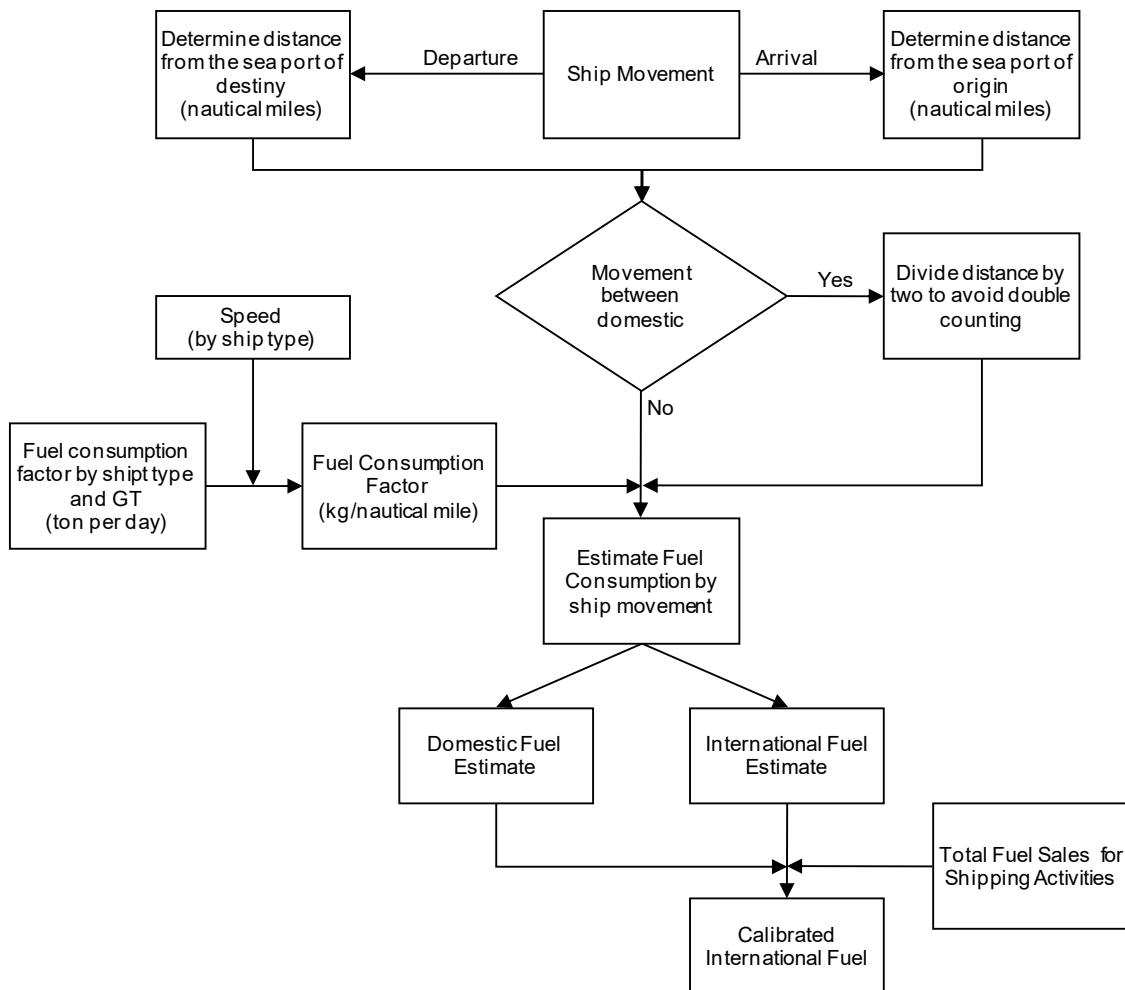

Figure 3-43: Generic methodology flowchart.

For each dock (which includes one arrival and one departures) is possible to calculate domestic and international distance and fuel consumption.

Domestic and international fuel consumption is estimated with a bottom-up approach using the fuel consumption factors and distance travelled by each ship. The fuel consumption factors, in tonne/day, is calculated with the gross tonnage of each ship and converted to kg/nautical miles with the ship speed. Detailed ship movements and ships technical information (such as gross tonnage, ship type and speed) is provided by National Seaports.

The international fuel consumption estimated is calibrated with the total fuel sales data from the energy balance provided by the energy authority (DGEG). This top down calibration does not affect the domestic fuel consumption estimated with the bottom-up approach.

Domestic navigation also takes into account the tugs fuel consumption for each maneuvering.

Since emissions factors vary according with the type of fuel, to distinguish between residual and distillate fuel we consider the fraction of distillate fuel oil and residual fuel oil sold in marine bunkers.

3.5.4.3 Emission Factors

Emission factors and energy content were obtained from several sources. The energy content of residual and distillate fuels was provided by the energy authority (DGEG). The carbon emission factors, expressed in t/TJ, and the CH₄ and N₂O emission factors were obtained from IPCC 2006 Guidelines.

**Table 3-67: Low Heating Value (LHV) – Navigation.**

Fuel	L	NAPFUE	LHV
			MJ/kg
Gas-oil	L	204	42.60
Residual Fuel-oil	L	203	40.00

Source: DGEG

Table 3-68: Carbon content – Navigation.

Fuel	Default carbon content		
	Value	Unit	Reference
Gas-oil	20.20	t/TJ	IPCC 2006
Residual Fuel-oil	21.10	t/TJ	IPCC 2006

Table 3-69: Emission factors for Greenhouse gases – Navigation.

Fuel	CO ₂			CH ₄			N ₂ O		
	Value	Unit	Reference	Value	Unit	Reference	Value	Unit	Reference
Gas-oil	74.1	t/TJ	IPCC 2006	7.0	kg/TJ	IPCC 2006	2.0	kg/TJ	IPCC 2006
Residual Fuel-oil	77.4	t/TJ	IPCC 2006	7.0	kg/TJ	IPCC 2006	2.0	kg/TJ	IPCC 2006

The fuel consumption factors (expressed in tonne per day) are dependent from the ship type and from the gross tonnage. The equations used to derive fuel consumption factors were obtained from IPCC 2006.

Table 3-70: Consumption factors.

Ship Type	Consumption at full power (tonne/day) ^(a)
Solid bulk	$20.186 + 0.00049 \times \text{gt}$
Liquid bulk	$14.685 + 0.00079 \times \text{gt}$
General cargo	$9.8197 + 0.00143 \times \text{gt}$
Container	$8.0552 + 0.00235 \times \text{gt}$
Passenger/Ro-Ro/Cargo	$12.834 + 0.00156 \times \text{gt}$
Passenger	$16.904 + 0.00198 \times \text{gt}$
High speed ferry	$39.483 + 0.00972 \times \text{gt}$
Inland cargo	$9.8197 + 0.00143 \times \text{gt}$
Sail ships	$0.4268 + 0.00100 \times \text{gt}$
Tugs	$5.6511 + 0.01048 \times \text{gt}$
Fishing	$1.9387 + 0.00448 \times \text{gt}$
Other ships	$9.7126 + 0.00091 \times \text{gt}$
All ships	$16.263 + 0.001 \times \text{gt}$

Legend:

gt – gross tonnage

^(a) – a factor of 0.8 was applied to obtain consumption for cruise.

Source: (IPCC 2006)

3.5.4.4 Activity Data

3.5.4.4.1 Ships movements in national sea ports

The activity data from navigation is based on ship movement for individual ships in each national seaport comprehending nine ports in Portugal mainland and four in islands of Madeira and Azores.

The data provided by national seaports reports to the years 1990 and 1995; and to the period between 2000 and 2020. The number of movements and the distances travelled for the period 1991-1994 and 1996-1999 were estimated according with an interpolation established between years with available data.



For most cases, data on origin and destiny was also available per movement which allowed to estimate the distances travelled and to distinguish between domestic and international movements.

Table 3-71: Ship docks.

Sea Port	Location	Unit	1990	1995	2000	2005	2010	2015	2019	2020	2021
Aveiro	Mainland	docks	876	1 098	1 009	1 028	961	1 025	1 066	990	1 055
Canical	Madeira	docks	76	76	76	178	390	241	252	246	241
Faro	Mainland	docks	163	163	163	32	12	85	29	46	15
Figueira da Foz	Mainland	docks	315	297	307	321	476	496	469	484	401
Funchal	Madeira	docks	1 063	1 063	1 063	948	758	664	757	382	502
Leixões	Mainland	docks	2 742	2 896	3 050	2 814	2 612	2 735	2 583	2 477	2 410
Lisboa	Mainland	docks	5 586	4 993	3 869	3 474	3 129	2 605	2 595	1 661	1 661*
Ponta Delgada	Azores	docks	1 080	1 080	1 080	1 078	1 035	831	827	684	722
Portimão	Mainland	docks	34	34	37	42	136	70	74	4	24
Porto Santo	Madeira	docks	402	402	402	400	392	348	390	318	363
Setúbal	Mainland	docks	1 453	1 453	1 699	1 592	1 632	1 627	1 532	1 598	1 576
Sines	Mainland	docks	1 038	979	808	1 124	1 632	2 173	2 117	1 989	1 949
Viana do Castelo	Mainland	docks	254	293	348	214	179	198	195	202	250

* provisional data

3.5.4.4.2 Ship Fleet

The fleet from the figure below refers to all ships that docked in national seaports irrespective of domestic or international movements.

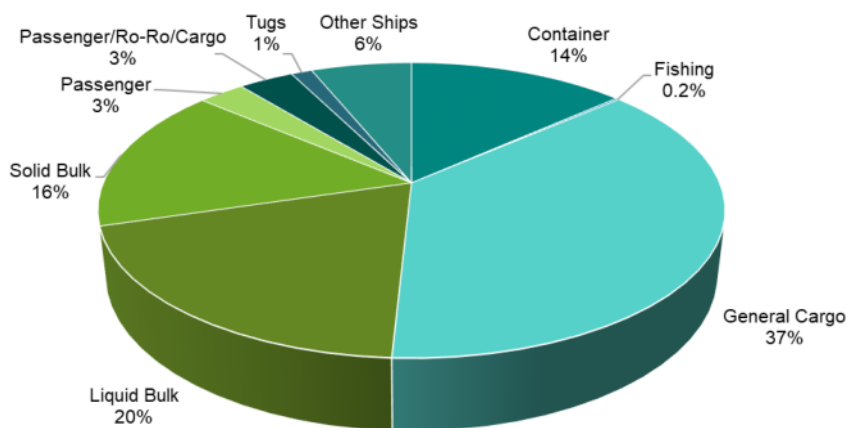

Figure 3-44: Ship fleet.

3.5.4.4.3 Fuel consumption

Fuel consumption is estimated with a bottom-up approach using fuel consumption factors combined with a top-down calibration with the energy balance. In a first step, domestic and international consumption are estimated with the bottom up approach. Then the international consumption is re-calculated by subtracting the estimated domestic consumption from the total sales reported in the energy balance, this is considered the top down calibration. This calibration does not affect the domestic fuel consumption calculated with the bottom-up approach.

$$FuelConsumption_{International} = FuelSales - FuelConsumption_{Domestic}$$

**Table 3-72: Total fuel sales (ton).**

Fuel Sales	NAPFUE	1990	1995	2000	2005	2010	2015	2019	2020	2021	
Gas-oil	L	204	126 903	141 272	125 554	110 197	94 064	139 277	181 216	157 452	171 050
Residual Fuel-oil	L	203	407 823	290 920	475 743	457 115	506 320	603 295	894 060	613 084	586 415

Source: DGEG

Table 3-73: Estimated fuel consumption (ton).

Fuel	Region	1990	1995	2000	2005	2010	2015	2019	2020	2021
Residual Fuel-oil	Domestic	61 244	53 023	46 988	48 804	53 458	65 968	62 927	47 037	48 312
Residual Fuel-oil	International	431 554	448 716	430 253	411 428	515 738	805 707	764 680	782 099	688 862
Residual Fuel-oil	Total	492 797	501 739	477 242	460 233	569 196	871 676	827 607	829 136	737 175
Gas-oil	Domestic	23 132	20 027	17 748	18 434	20 192	24 917	23 768	17 766	18 248
Gas-oil	International	163 002	169 485	162 511	155 401	194 799	304 324	288 827	295 407	260 190
Gas-oil	Total	186 135	189 512	180 259	173 835	214 991	329 241	312 595	313 173	278 438

Table 3-74: Estimated fuel consumption after top-down calibration (ton).

Fuel	Region	1990	1995	2000	2005	2010	2015	2019	2020	2021
Residual Fuel-oil	Domestic	61 244	53 023	46 988	48 804	53 458	65 968	62 927	47 037	48 312
Residual Fuel-oil	International	346 579	237 897	428 754	408 311	452 862	537 327	831 133	566 047	538 103
Residual Fuel-oil	Total	407 823	290 920	475 743	457 115	506 320	603 295	894 060	613 084	586 415
Gas-oil	Domestic	23 132	20 027	17 748	18 434	20 192	24 917	23 768	17 766	18 248
Gas-oil	International	103 770	121 244	107 806	91 763	73 872	114 360	157 448	139 685	152 802
Gas-oil	Total	126 903	141 272	125 554	110 197	94 064	139 277	181 216	157 452	171 050

3.5.4.4.3.1 Tugs Fuel consumption

Data concerning tugs assistance operations within the national seaports allowed the incorporation of these emissions in the inventory. Tug fuel consumption was estimated for each manoeuvring ship in a seaport following the criteria shown in the next Table. Specific tug fuel consumption factors were supplied by DGRM.

Table 3-75: Criteria employed in the tugs fuel consumption estimation.

Ship Type	Seaport	Assisted Arrivals (%)	Assisted Departures (%)	N.º Of Tugs/Arrival	N.º Of Tugs/Departure
Small Size	All	20	0	1	0
Medium Size	All	50	25	1	1
Large Size	All	100	100	2	1
Super Large Size	Sines and Leixões	100	100	3	2
Super Large Size	All except Sines and Leixões	100	100	2	2

This estimation required the ship size classification expressed in table below.

Table 3-76: Ship type classification for tugs fuel consumption estimation.

Ship Type	gt
Small Size	gt≤1000
Medium Size	10000≤gt<1000
Large Size	50000≤gt<10000
Super Large Size	gt>50000

gt: gross tonnage

Finally the fuel consumption was added to the ship that needed the tugs service. The fuel tables presented above include fuel consumption in tugs operations.



3.5.4.5 Uncertainty Assessment

Activity level uncertainty refers to the fuel consumption uncertainty which depends on the number of movements, the distance travelled and fuel consumption factors. The global uncertainty is therefore obtained from:

$$U_{global} = \sqrt{U_{movements}^2 + U_{distance}^2 + U_{FC}^2}$$

Movement's uncertainty was assumed to be 5% as suggested in IPCC Good Practice Guidance and Uncertainty Management. The distance uncertainty was calculated assuming that ships speeds were constant between origin and destiny seaports. This allows the indirect assessment of the uncertainty trough the travelling time between seaports. For the same OD it is possible to estimate uncertainty according with differences between travelling times performed by the same type of ships. Finally, it was assumed an uncertainty of 48% for fuel consumption factors proposed by EMEP/EEA. Activity level uncertainty was estimated about 50% as referred in the next Table.

Table 3-77: Navigation activity level uncertainty.

Source	Parameter	Value
All	Uglobal	50%
Movements	Umovements	5%
Distance Travelled	Udistance	15%
Fuel Consumption Factor	Ufc	48%

Following the recommendations of GPG the uncertainties of emission factor for CH₄ and N₂O, and for all types of vessels and navigation, were set respectively to 100% and 1000%.

3.5.4.6 Category-specific QA/QC and verification

Energy consumption was compared with data from the energy balance reported by DGEG. No differences were found between total fuel estimated with the described methodology and total fuel reported in the energy balance.

3.5.4.7 Recalculations

No recalculations were made.

3.5.4.8 Further Improvements

No further improvements are planned for this sector.



3.5.5 Other Mobile Sources (CRF 1.A.3.e)

3.5.5.1 Category description

Pipeline transportation activities in Portugal are exclusively supported by electricity, therefore no combustion emission are considered in 1.A.3.e.i (Pipeline Transport)

Fuel consumption for off-road (1.A.3.e.ii), like ground activities in airports and offroad activities not otherwise reported under Agriculture (1.A.4.c) or Manufacturing Industries and Construction (1.A.2), is reported in the Portuguese Energy Balance under the item “Serviços” and the related combustion emission are included in the category Commercial/Institutional (under Other Sectors – 1.A.4) because is not possible to separate the fuel consumption for this sectors in the Energy Balance.



3.6 Other Sectors (CRF 1.A.4)

3.6.1 Category description

This source category refers to combustion in stationary and mobile sources (off-road) equipments that occur in commercial/institutional, residential, and agriculture/forestry/fishing activity sectors. The following stationary combustion equipments were included in this sector: boilers, co-generation equipment, machines and static engines are included in sector. Also included in 1.A.4 are emissions from fisheries bunkers and off road-vehicles in agriculture/ forestry sector. Emissions resulting from mobile equipment associated with the "Commercial / Institutional" and "Residential" sub-sectors are also considered.

In the 2020 submission there was a thorough review of the methodology for estimating GHG emissions for this category. This involved estimating new sub-categories, reviewing activity data and updating emission factors.

In the table below it is possible to consult the subcategories considered in Other Sectors (CRF 1.A.4).

Table 3-78: Subcategories considered and coverage of estimated Greenhouse gases

CRF Category	Categories	GHG's coverage	Source Category
1A4ai	Commercial/institutional: Stationary combustion	CO ₂ , CH ₄ and N ₂ O	Industrial & commercial combustion Public sector combustion Railways - stationary combustion
1A4aii	Commercial/institutional: Off-road vehicles and other machinery	CO ₂ , CH ₄ and N ₂ O	Commercial mobile sources
1A4bi	Residential: Stationary combustion	CO ₂ , CH ₄ and N ₂ O	Domestic combustion
1A4bii	Residential: Household and gardening	CO ₂ , CH ₄ and N ₂ O	House and garden machinery
1A4ci	Agriculture/Forestry/Fishing: Stationary combustion	CO ₂ , CH ₄ and N ₂ O	Agriculture and Fishing stationary combustion
1A4cii	Agriculture/Forestry/Fishing: Off-road vehicles and other machinery	CO ₂ , CH ₄ and N ₂ O	Agriculture - tractors and mobile machinery
1A4ciii	Agriculture/Forestry/Fishing: National fishing	CO ₂ , CH ₄ and N ₂ O	Fishing Vessels

In 2021, the Other Sectors category accounted for 4.41 Mt (7.6%) of Portugal's total GHG emissions, with a 6.5% (0.27 Mt) increase in overall emissions since 1990 (refer to Table 3-74 for more details). Within the Other Sectors category, 2.05 Mt (46.6%) of the GHG emissions are from the Residential sector, this subcategory is followed by, in order of decreasing contributions, Agriculture/Forestry/Fishing (1.36 Mt, 30.9%), and Commercial/institutional (0.99 Mt, 22.5%) subcategories.



Table 3-79: Estimated emissions from Other Sectors (Gg CO₂ eq.)

Source /Gas	1990	2005	2019	2020	2021	Δ	Δ	Δ	
						2021-2020	2021-2005	2021-1990	
kt CO ₂ eq.						%			
1.A.4.a Commercial/institutional									
CO ₂	704.5	3 024.7	1 133.7	961.0	982.4	2.2	-67.5	39.4	
CH ₄	1.0	1.7	0.9	0.7	0.8	7.9	-54.0	-20.3	
N ₂ O	2.3	10.2	8.6	6.8	7.2	6.1	-29.4	212.6	
1.A.4.b Residential									
CO ₂	1 639.9	2 388.9	1 816.4	1 905.0	1 730.0	-9.2	-27.6	5.5	
CH ₄	479.4	293.1	235.5	239.1	237.9	-0.5	-18.8	-50.4	
N ₂ O	151.7	102.4	84.1	86.0	85.8	-0.2	-16.2	-43.4	
1.A.4.c Agriculture / Forestry / Fishing									
CO ₂	1 118.9	1 303.0	1 187.5	1 285.6	1 303.3	1.4	0.0	16.5	
CH ₄	2.2	2.0	3.7	3.8	2.6	-32.2	26.2	15.3	
N ₂ O	38.9	55.6	50.4	55.4	56.9	2.7	2.3	46.4	
Total	CO ₂	3 463.3	6 716.6	4 137.6	4 151.5	4 015.7	-3.3	-40.2	15.9
	CH ₄	482.6	296.8	240.1	243.6	241.3	-1.0	-18.7	-50.0
	N ₂ O	192.8	168.2	143.2	148.1	149.9	1.2	-10.9	-22.3
Total	All gases	4 138.8	7 181.6	4 520.9	4 543.3	4 406.8	-3.0	-38.6	6.5

Note: Totals may not sum due to independent rounding. Emissions values are presented in CO₂eq mass units using IPCC AR5 GWP values (CH₄ - 28; N₂O - 265).

Key categories

Four key categories have been identified for this sector in 2021, for level and trend assessment, using both the IPCC Approach 1 and Approach 2:

Table 3-80: Key categories in Other Sectors (CRF 1.A.4) and methodologies used in emission estimates

IPCC category	Gas	Criteria	Method
1.A.4 Combustion Other Sectors - Liquid fuels	CO ₂	L,T	T1
1.A.4 Combustion Other Sectors - Gaseous fuels	CO ₂	L,T	T2
1.A.4 Combustion Other Sectors - Biomass	CH ₄	L,T	T2,T1
1.A.4 Combustion Other Sectors - Liquid fuels	N ₂ O	L,T	T2,T1



3.6.2 Methodology

This category underwent profound methodological changes during this submission, which allow to apply higher methodological tiers for estimating CH₄ and N₂O emissions for key categories. It also allowed the separation between stationary combustion and mobile combustion for the Commercial / institutional and Residential subcategories. The table below summarizes the methodological approaches adopted and the main source of emissions for each sub-category.

Table 3-81: Methodological approaches and main source of emissions for each sub-category

Categories	Method Approach	Main source of emissions
Commercial/institutional		
1A4ai - Stationary combustion	TIER 2 - Technology-specific TIER 2 - Country specific TIER 1 - Energy consumption	Combustion of diesel and natural gas in Commercial and Public plants for space heating
1A4aii - Mobile	TIER 1 - Energy consumption	Combustion of liquid fuels in mobile sources
Residential		
1A4bi - Stationary combustion	TIER 2 - Technology-specific TIER 2 - Country specific TIER 1 - Energy consumption	Combustion of wood and LPG in households for space heating, water heating and cooking
1A4bii - Household and gardening	TIER 1 - Energy consumption	Combustion of Liquid fuels in mobile sources
Agriculture / Forestry / Fishing		
1A4ci - Stationary combustion	TIER 2 - Technology-specific TIER 2 - Country specific TIER 1 - Energy consumption	Combustion of diesel for heating purposes
1A4cii - Off-road vehicles and other machinery	TIER 1 - Energy consumption	Combustion of diesel in tractors and other agricultural machinery
1A4ciii - National fishing	TIER 1 - Energy consumption	Combustion of diesel in deep sea and coastal fishing vessels

To apply a TIER 2 methodology its required information on the fuels and technologies used in the sector. While fuel consumption, by this type of fuel, is easily obtained through the National Energy Balance, a consistent time series that correctly characterizes the split technology of this sector is not available.

Previously, the Inventory used as a source of information for the technological split, a survey on energy consumption in the Residential Sector (DGEG), which characterized only the year 2010.

Although the information was detailed regarding some of the thermal uses and equipment used, it failed in the task of portraying the time series.

Thus, in order to apply the Tier 2 methodology to these key categories, the Inventory relied on two sources of information:

- Appliance type split according to IIASA GAINS²¹ model for years 2000, 2005 and 2010

²¹ Tables 3.36, 3.37 and 3.38 of EMEP/EEA Guidebook – 1A4 Small Combustion 2016



- Thermal uses split according to JRC-IDEES ²²database between 2000 and 2015

In both cases, since this information does not cover the entire time series, the missing years have been estimated through interpolations and extrapolations. The result of this estimate can be found ahead in section 3.6.3.1 Technology Split.

IIASA's Appliance type split was applied only to wood combustion in the residential sector, and allowed to disaggregate the consumption of wood by type of equipment.

The JRC-IDEES Database allowed to apply a split based on Thermal Use (space heating, water heating and cooking) for the most significant fuels in each sub-sector. In order to apply technology dependent emissions factors, it was chosen based on the 2010* Survey to the residential sector, which equipment is associated with each type of thermal use, thus having a better characterization of the appliances used in Portugal. The choice of end-use technology can be found in the section 3.2.6.4 Emission Factors.

Below we describe the methodological approaches considered for the estimation of emissions.

General Approach for Tier 2 Method

The Tier 2 approach for emissions from category 1.A.4 uses the general equation:

$$E_i = \sum_j \sum_k EF_{i,j,k} \cdot A_{j,k}$$

where

E_i – annual emission of pollutant i ,

$EF_{i,k,j}$ – default emission factor of pollutant i for appliance type j and fuel k ,

$A_{j,k}$ – annual consumption of fuel k in appliance type j .

General Approach for Tier 1 Method

The Tier 1 approach for emissions from category 1.A.4 uses the general equation:

$$E_{\text{pollutant}} = AR_{\text{fuelconsumption}} \times EF_{\text{pollutant}}$$

where

$E_{\text{pollutant}}$ – the emission of the specified pollutant,

$AR_{\text{fuelconsumption}}$ – the activity rate for fuel consumption,

$EF_{\text{pollutant}}$ – the emission factor for this pollutant.

²² JRC-IDEES is developed by the European Commission's Joint Research Centre and offers a consistent set of disaggregated energy-economy-environment historical time series from the year 2000 onwards for all EU Member States



3.6.3 Activity Data

3.6.3.1 Technology Split

As explained in the previous point the technological split was made based on two different sources - IIASA GAINS Model and JRC-IDEES Database.

Commercial and Institutional sector, it is characterized on the one hand by the heating needs supplied by Diesel and Natural Gas in small plants of heat generation and by the other side by the consumption of LPG and Solid Biomass in the Restoration sector.

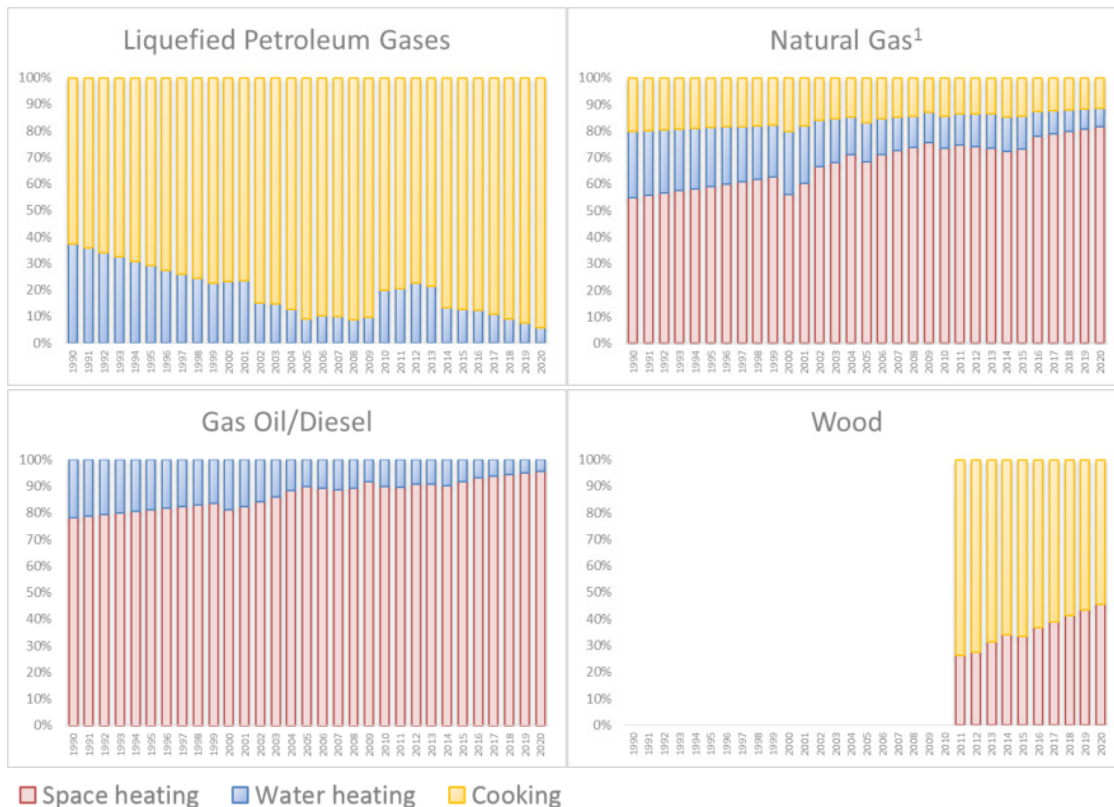
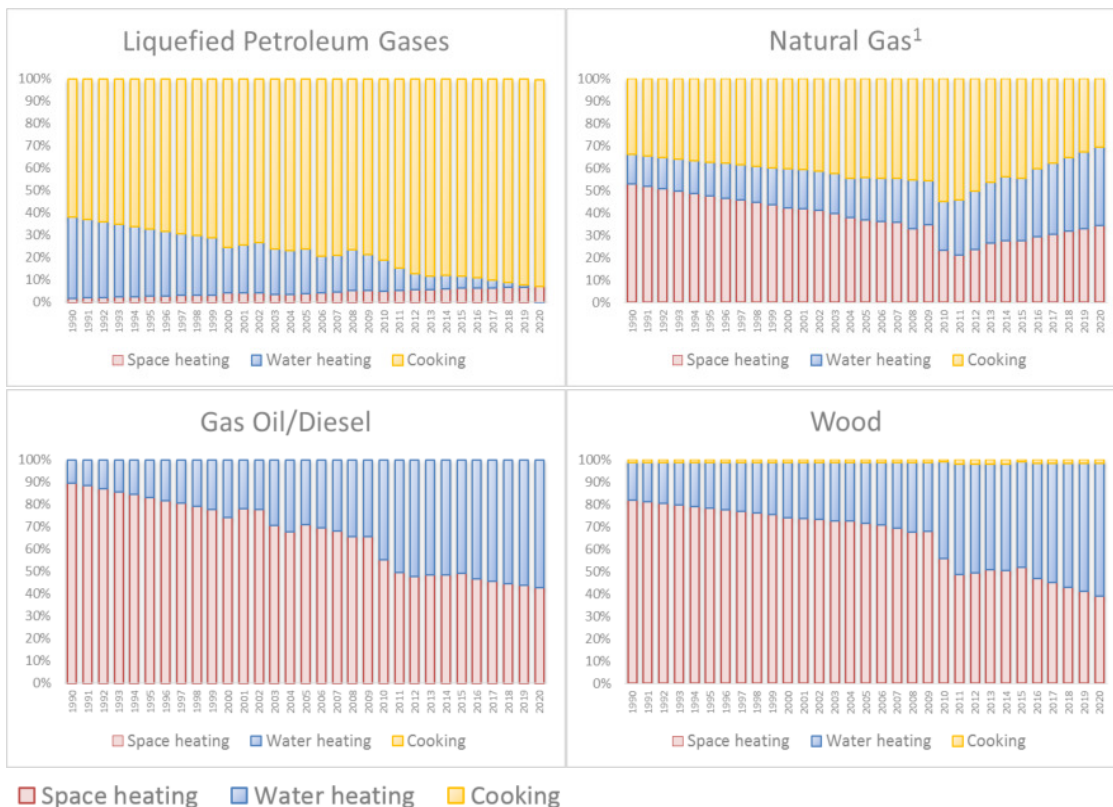

Figure 3-45: Split in Thermal Uses for Commercial/Institutional Sector

In the residential sector, the main fuels consumed are LPG and solid Biomass. Between the two are covered the three types of thermal uses. Since LPG is preferentially used in stoves intended for cooking, and the wood is burned in stoves, boilers and fireplaces for the purpose of space heating. Another trend observed between these two fuels is the use of wood in the heating of water from 2010, coinciding with the reduction of LPG consumption for this purpose. See figure below.



1 Include Gas Work Gas

Figure 3-46: Split in Thermal Uses for Residential Sector

The figure below shows the split in appliances/technologies considered for the residential combustion of wood. The main trend observed is the replacement of Conventional Stoves with more modern technologies like pellets stoves, pellets boilers and automatic boilers. Even so, the appliances used in Portugal can be considered as traditional since, even in recent years, conventional stoves and boilers as well as open fireplaces represent about 80% of the consumption of wood.

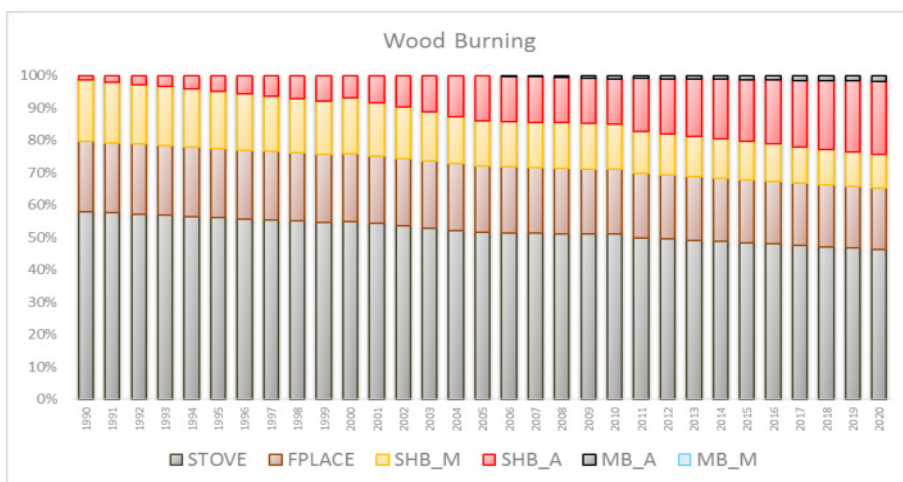

STOVE - Conventional stoves; FPLACE - Open fireplaces; SHB_M - Conventional boilers
SHB_A - Pellet stoves and boilers; MB_A - Automatic Boilers; MB_M - Wood combustion

Figure 3-47: Split in appliances/technologies for Residential Sector – Wood Burning

The methodological update made this year, allowed to separate more correctly the consumption of Diesel in the Agriculture sector. Until then, it was considered that all Diesel consumed in this sector was attributed to combustion in tractors and other off-road machines.



Using the information from JRC-IDEES Database, we can conclude that this assumption would be incorrect, and diesel consumption of these vehicles represents about 50% of the total diesel consumption of agricultural sector.

This correction in diesel consumption resulted in the allocation of emissions from the category Off-road vehicles and machinery (1A4cii) to the category Agriculture/Forestry/Fishing: Stationary (1A4ci). Assuming that these allocated emissions refer to heating and pumping activities by stationary sources in agriculture.

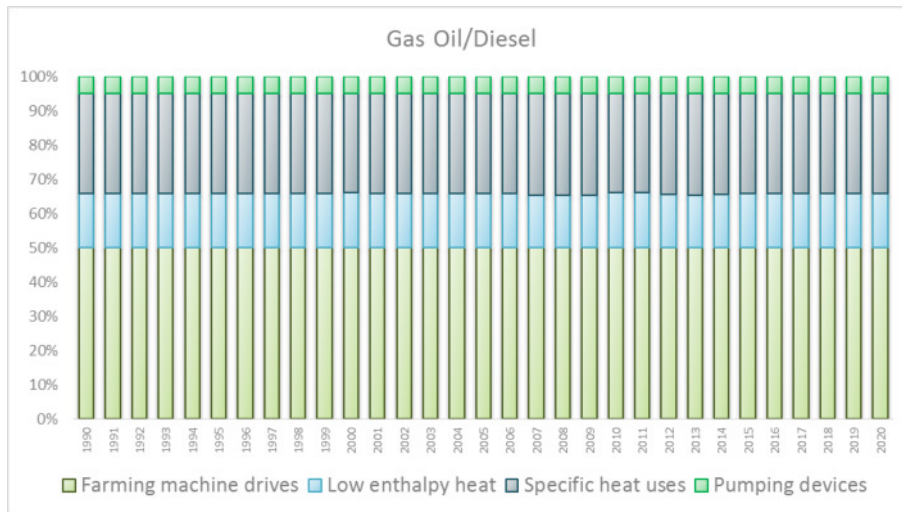

Figure 3-48: Split in Thermal Uses for Agriculture Sector - Diesel

3.6.3.2 Energy consumption

Data on fuel consumption was obtained from the annual energy balances compiled by DGEG and are presented in the following figures and ANNEX A.

Commercial/Institutional

Natural Gas, more recently, and Diesel, until 2010, are the main fuels used in the combustion that occurs in the Commercial sector. Both are generally used in the production of heat by small plants. As mentioned above, the consumption of diesel was higher in the period between 1990 and 2010, after which it was replaced by natural gas and electric heating solutions. This electrification trend also leads to a small increase of the cogeneration share in this sector.

Another use that has gained some preponderance in the last years has been the combustion for the purpose of cooking. Here the main fuel is the LPG that is supplied to the restaurant now through piped LPG or through propane and butane jars.

The Diesel/Gas Oil time series show a drop in consumption from 2005 to 2006. This fact results from reallocation, in the energy balance, of road gas oil from services not specified to agriculture (DGEG). There is a decrease in diesel oil consumption in 2010 for the services sector that results from the incorporation of data from the 2010 Survey on Energy Consumption in the Residential Sector. This decrease is coupled with an increase in diesel consumption in the residential sector.

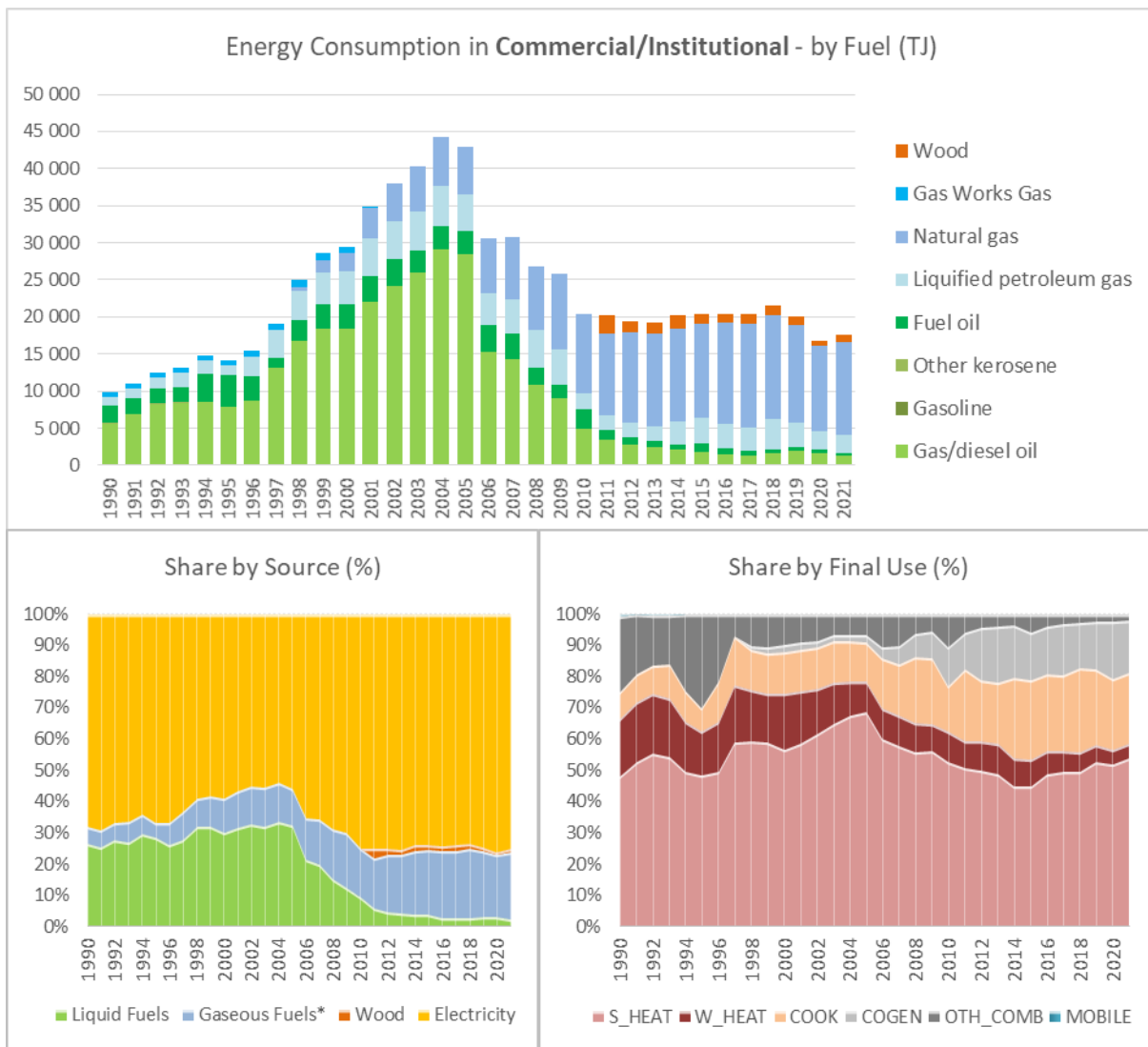

S_HEAT: Space Heating; W_HEAT: Water Heating; COOK: Cooking; OTH_COMB: Other Combustion

Figure 3-49: Energy consumption in Commercial/Institutional sector - by Fuel, Source and Final Use

Residential

In the Residential sector, solid biomass and LPG are the main fuel consumed. With LPG being mainly used for the purpose of cooking, and the solid biomass being used for heating both water and space.

The trend of decreasing energy consumption in this sector has been done a lot thanks to electrification of the same, this statement has main importance in the reduction of wood consumption, since nowadays, the Portuguese population uses more electrified equipment's for space heating than in the 90s.

Also Natural Gas has some highlight in the consumption of this sector, having gained market share through solutions that cover the entire spectrum of thermal solutions (space heating, water heating and cooking)

There is an increase in diesel oil consumption in 2010 for the residential sector that results from the incorporation of data from the 2010 Survey on Energy Consumption in the Residential Sector. This increase is coupled with a decrease in diesel consumption in the services sector.

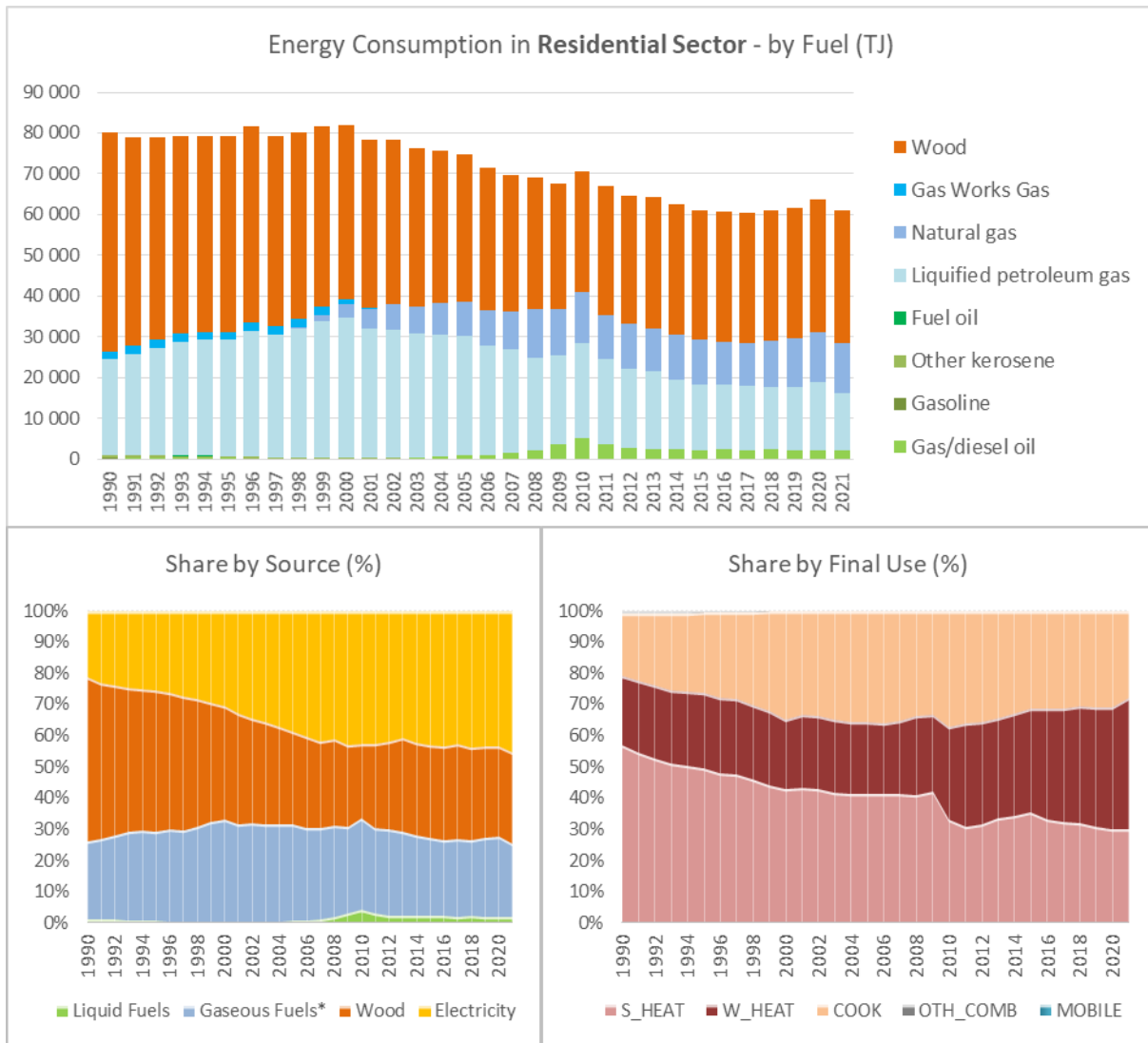

S_HEAT: Space Heating; W_HEAT: Water Heating; COOK: Cooking; OTH_COMB: Other Combustion

Figure 3-50: Energy consumption in Residential sector - by Fuel, Source and Final Use

Agriculture

In this sector the main fuel is diesel, the consumption of which is distributed by both stationary and mobile sources.

There is still some electrification in this sector, with consumption referring to stationary consumption. And a residual portion of cogeneration, currently produced through the combustion of natural gas and biogas.

One of the main end uses of fossil fuels in these subsectors are agricultural machines and tractors, responsible for more than 40% of energy consumption. These mobile sources have a particular preponderance in the N₂O emissions of the subcategory 1.A.4.c Agriculture / Forestry / Fishing.

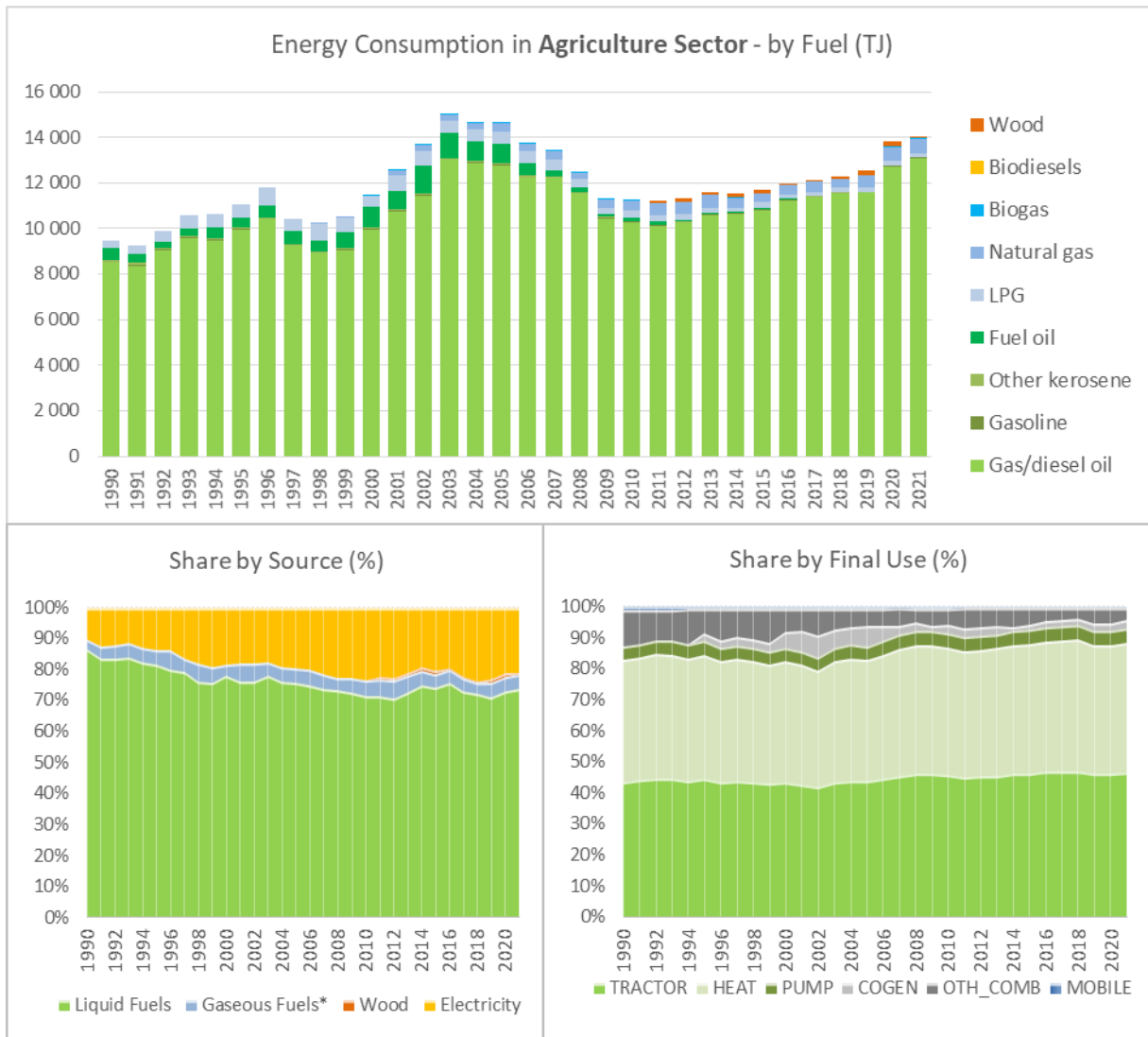

TRACTOR: Mobile machinery; HEAT: Heat uses; PUMP: Pumping devices; COGEN: Cogeneration; OTH_COMB: Other Combustion

Figure 3-51: Energy consumption in Agriculture sector - by Fuel, Source and Final Use

Fishing

In fishing sector like in agriculture sector, diesel is the main fuel consumed, being used by both mobile and stationary sources. Electricity consumption in this sector is very low, but the share has nevertheless increased in the last decade. The trend of growth of consumption by source sources needs to be clarified because it may result from an inefficient separation between costal fishing consumption and stationary sources.

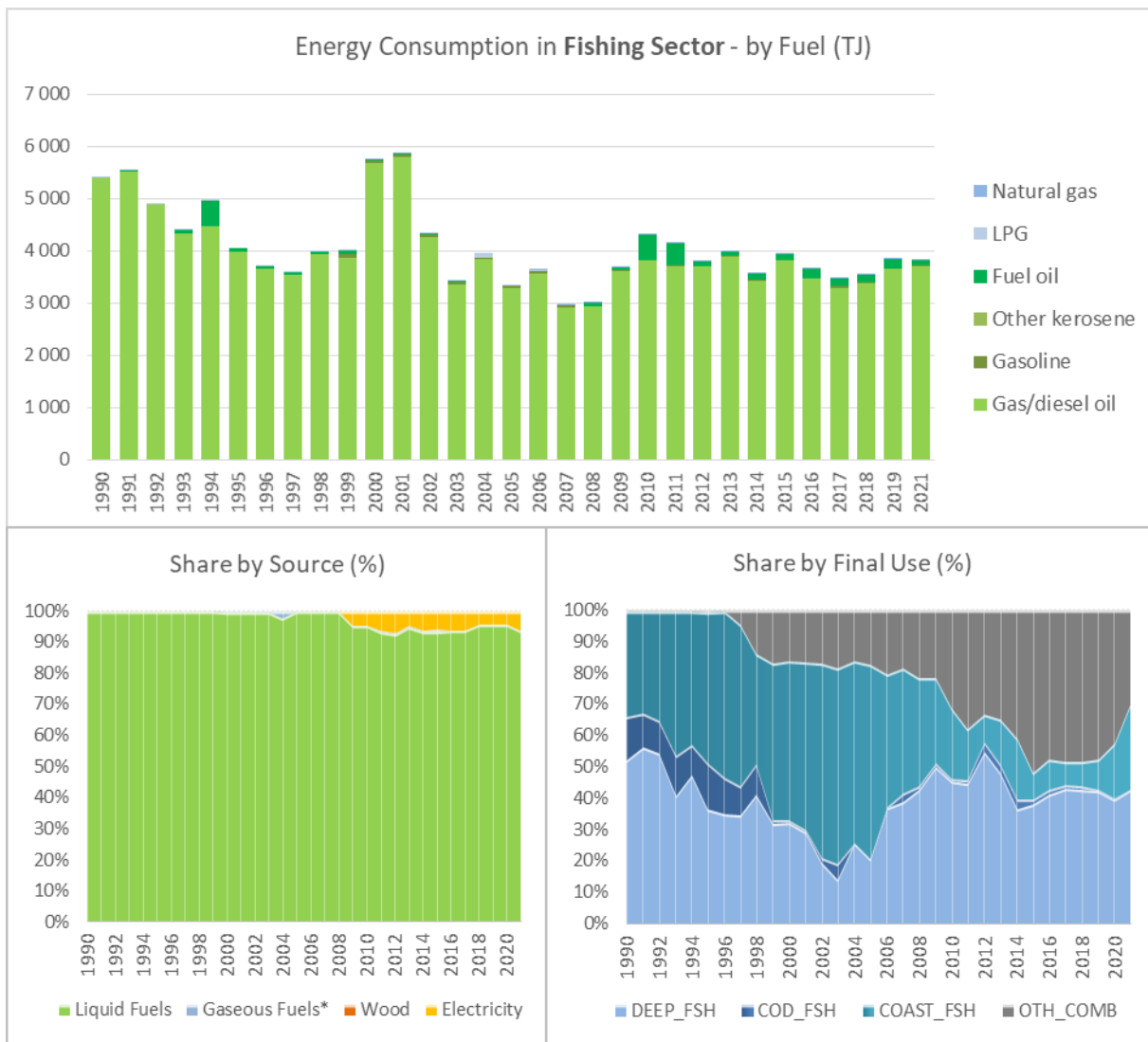

DEEP_FSH: Deep Sea Fishing; COD_FSH: Cod Fishing; COAST_FSH: Coastal Fishing; OTH_COMB: Other Combustion

Figure 3-52: Energy consumption in fishing sector - by Fuel, Source and Final Use



3.6.4 Emission Factors

Table 3-82: Emissions factors for Category 1.A.4.a.i – Commercial/Institutional: Stationary

Fuel	Technology	CO ₂ ¹ kg/GJ	CH ₄ ¹ g/GJ	N ₂ O ¹ g/GJ
Liquefied Petroleum Gases	Medium Boilers ²	63.1	0.9	4.0
	Stove, Hobs and Ovens ²	63.1	0.9	4.0
Natural Gas ⁴	Medium Boilers	56.4	1.0	1.0
	Heat Pump	56.4	1.0	1.0
	Stove, Hobs and Ovens	56.4	1.0	1.0
	Gas Turbines ³	56.4	0.3	0.1
Gas Work Gas	Medium Boilers	44.4	5.0	0.1
	Heat Pump	44.4	5.0	0.1
	Stove, Hobs and Ovens	44.4	5.0	0.1
	Gas Turbines	44.4	5.0	0.1
Gas Oil	Medium Boilers ²	74.1	0.7	0.4
Wood and Wood Waste	Medium Boilers ²	112.0	11.0	7.0
	Ovens ²	112.0	11.0	7.0
Fueloil	Boilers (> 50KWth <1MWth) ³	77.4	3.0	0.6
	Boilers (> 1MWth <50MWth)	77.4	10.0	0.6

1 Source: 2006 IPCC Guidelines - Volume 2: Energy - 1A Stationary Combustion [Table 2.4]

2 Source: 2006 IPCC Guidelines - Volume 2: Energy - 1A Stationary Combustion [Table 2.10]

3 Source: 2006 IPCC Guidelines - Volume 2: Energy - 1A Stationary Combustion [Table 2.2]

4 CO₂ EF for Natural Gas is Country Specific

Table 3-83: Emissions factors for Category 1.A.4.b.i – Residential: Stationary

Fuel	Technology	CO ₂ ¹ kg/GJ	CH ₄ ¹ g/GJ	N ₂ O ¹ g/GJ
Liquefied Petroleum Gases	LPG Heaters ²	63.1	1.1	4.0
	Condensing boilers ³	63.1	0.9	4.0
	Stove, Hobs and Ovens	63.1	5.0	0.1
Natural Gas ⁴	Small Boilers	56.4	1.0	1.0
	Condensing boilers	56.4	1.0	1.0
	Stove, Hobs and Ovens	56.4	1.0	1.0
Gas Work Gas	Small Boilers	44.4	1.0	1.0
	Condensing boilers	44.4	1.0	1.0
	Stove, Hobs and Ovens	44.4	1.0	1.0
Gas Oil	Small Boilers ³	74.1	0.7	0.4
Wood and Wood Waste	Heating stoves ^{2,5}	112.0	428.5	11.3
	Open fireplaces ²	112.0	300.0	9.0
	Conventional boilers <50 kWth ³	112.0	11.0	7.0
	Pellet stoves and boilers ³	112.0	11.0	7.0
	Automatic Boilers <1MW ³	112.0	11.0	7.0
	Manual Boilers <1MW ³	112.0	11.0	7.0
Fueloil ¹	-	77.4	10.0	0.6
Other Kerosene ¹	-	71.9	10.0	0.6

1 Source: 2006 IPCC Guidelines - Volume 2: Energy - 1A Stationary Combustion [Table 2.4]

2 Source: 2006 IPCC Guidelines - Volume 2: Energy - 1A Stationary Combustion [Table 2.9]

3 Source: 2006 IPCC Guidelines - Volume 2: Energy - 1A Stationary Combustion [Table 2.10]

4 CO₂ EF for Natural Gas is Country Specific

5 Average of non-catalytic and catalytic EF's for wood stoves

**Table 3-84: Emissions factors for Category 1.A.4.c.i – Agriculture / Forestry / Fishing: Stationary**

Fuel	Technology	CO ₂ ¹ kg/GJ	CH ₄ ¹ g/GJ	N ₂ O ¹ g/GJ
Gas Oil	Boilers (> 50KWth <1MWth) ²	74.1	0.7	0.4
	Reciprocating engines ²	74.1	0.7	0.4
Liquefied Petroleum Gases	Boilers (> 1MWth <50MWth)	63.1	5.0	0.1
Natural Gas ⁴	Boilers (> 1MWth <50MWth)	56.4	5.0	0.1
	Gas Turbines ³	56.4	0.3	0.1
Wood Waste	Medium boilers (> 50kWth)	112.0	300.0	4.0
Fueloil	Boilers (> 50KWth <1MWth) ³	77.4	3.0	0.6
	Boilers (> 1MWth <50MWth)	77.4	10.0	0.6
Other Kerosene	-	71.9	10.0	0.6

1 Source: 2006 IPCC Guidelines - Volume 2: Energy - 1A Stationary Combustion [Table 2.4]

2 Source: 2006 IPCC Guidelines - Volume 2: Energy - 1A Stationary Combustion [Table 2.10]

3 Source: 2006 IPCC Guidelines - Volume 2: Energy - 1A Stationary Combustion [Table 2.2]

4 EF for Natural Gas is Country Specific

Table 3-85: Emissions factors for Categories 1.A.4.a.ii, 1.A.4.b.ii and 1.A.4.c.ii – Mobile sources

Fuel	Technology	CO ₂ ¹ kg/GJ	CH ₄ ¹ g/GJ	N ₂ O ¹ g/GJ
Gas Oil	Tractors, Harvesters, Others	74.1	4.2	28.6
Motor Gasoline 4-Stroke	Commercial: mobile	69.3	50.0	2.0
Other Kerosene	Commercial: mobile	71.9	50.0	2.0
Motor Gasoline 2-Stroke	Residential: mobile	69.3	180.0	0.4
Other Kerosene ²	Residential: mobile	71.9	180.0	0.4
Motor Gasoline 4-Stroke	Agriculture: mobile	69.3	80.0	2.0
Other Kerosene ²	Agriculture: mobile	71.9	80.0	2.0

1 Source: 2006 IPCC Guidelines - Volume 2: Energy - 1A Mobile Combustion [Table 3.3.1]

2 The other kerosene EFs for CH₄ and N₂O gases were considered equal to the EFs for gasoline.

Table 3-86: Emissions factors for Categories 1.A.4.c.iii – Mobile sources

Fuel	Technology	CO ₂ ¹ kg/GJ	CH ₄ ¹ g/GJ	N ₂ O ¹ g/GJ
Gas Oil	Fishing Vessels	74.1	7.0	2.0
Thick Fuel Oil	Fishing Vessels	77.4	7.0	2.0
Thin Fuel Oil	Fishing Vessels	77.4	7.0	2.0

1 Source: 2006 IPCC Guidelines - Volume 2: Energy - 1A Mobile Combustion [Table 3.5.2]



3.6.5 Uncertainty Assessment

The uncertainty in activity data was established from the knowledge of the way that activity data information was collected in the inventory but nevertheless trying as much as possible to make an assessment consistent to what is proposed in the GPG. Therefore, for fuel consumption except biomass, uncertainty was set at 10 %. For biomass fuels, considering that the quantification error is higher, namely due to lack of clarification of the actual moisture content in which biomass is reported, the uncertainty was assumed to be 60 %.

The uncertainty of CO₂ emission factors was assumed to be 5 % for all situations, in coherence with the other stationary combustion sources. In a similar mode, the uncertainties for methane and N₂O were set respectively at 150 % and an order of magnitude.

3.6.6 Category-specific QA/QC and Verification

To further improve the QA/QC analysis a comparison between fuel consumption values considered by the Inventory, reported by DGEG in Energy Balance and Eurostat Energy Balance was made.

The QA/QC analysis makes it evident that there are issues related to the allocation of consumption, consistency of the activity data series, both in the Eurostat and Energy Balance databases (see figure below).

The main problems identified in the “Other sectors” category relate to:

- Gasoline consumption in the Commercial / institutional subcategory (1990 – 2007)
- Biomass consumption in the Residential subcategory (1996 – 2010)
- Diesel consumption in the Agriculture / Forestry subcategory (1990 – 1997 & 2003 – 2004).

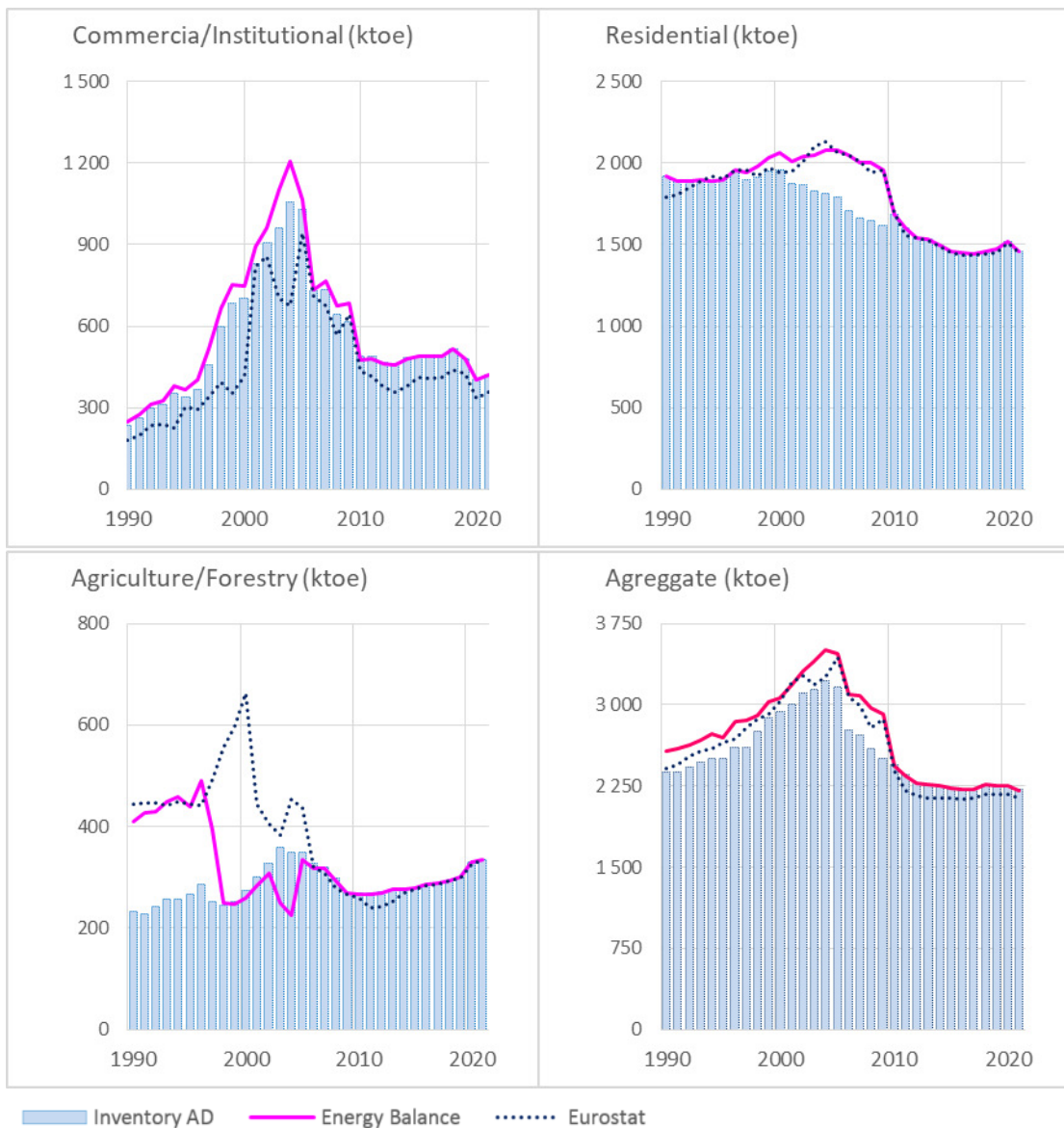

Figure 3-53: Energy consumption comparison between Inventory, National Energy Balance and EUROSTAT data by sector

The need to improve the consistency of the activity data series had long been identified. After working together with DGEG, the authority responsible for producing the energy balance, it was possible to obtain extra information that allowed the Inventory team to change the consumption time series.

Gasoline consumption in the Commercial / institutional subcategory (1.A.4.a)

Until 2007, the sale of gasoline affects the "Commercial / institutional" sector, mainly in public administration and defense, retail trade, machine rental, associative activities, hotels, post and telecommunications, diplomatic corps, etc. The end use of gasoline in these economic activities was essentially in transport.

Since 2008, with the entry into force of the methodological revision of the category classification, DGEG started to reallocate gasoline sales made to public gas stations, for the transport sector. Between 2008 and 2011, insignificant consumption of gasoline continues to be reported in this category of the Energy Balance.



In order to ensure consistency and accuracy, all gasoline sales reported in the "10.4 Services" category of the Energy Balance has been allocated to the Road Transport sector, with emissions from these gasoline consumption now estimated and reported in CRF category 1.A.3.b.

Biomass consumption in the Residential subcategory (1.A.4.b)

The inventory uses the Energy Balance as a source of information for the consumption of wood and wood products in the residential sector. The data published in the EB, originated in the publication "Survey on Energy Consumption in the Domestic Sector", which was carried out on three different dates 1989, 1996 and 2010. The results of the 2010 Survey show that there was a significant decrease in wood consumption between 1996 and 2010 (around -40%). The 2010 survey also concludes that, in relation to the energy consumption data reported in the 2009 Energy Balance: "Globally, the deviation stood at -8.9%, mainly due to wood, thus meeting expectations, given the known changes in consumption habits and the outdated information in previous editions of ICESD (used as a basis for preparing EB)".

In order to guarantee consistency throughout the time series, thus avoiding the series break between 2009 and 2010, it was assumed that there is a linear decrease in consumption between 1996 and 2010. This adjustment is the main reason for the differences in energy consumption between Inventory data and Energy Balance and Eurostat data.

Diesel consumption in the Agriculture / Forestry subcategory (1.A.4.c)

The introduction of colored and marked diesel for agriculture occurred in mid-1997. Until then, access to diesel for agriculture (cheaper than what was used for transport), was done through the presentation of a card (at gas stations), which proved that the buyer was engaged in this agriculture activity, with diesel fuel being the same as road diesel oil (without any marker). This method did not prevent the misuse of this fuel in automobiles. If we compare consumption in 1996 (last year that used this method in full) with consumption in 1998 (first year in which marked diesel was used) consumption in agriculture dropped to about half.

In order to identify the amount of diesel consumed in automobiles and other means of transport and reported incorrectly in the Energy Balance category "10.1.1 Agriculture", the ratio between diesel consumption and the Gross Value Added (GVA) of the sector was used between 1998-2016 to estimate consumption for the period 1990-1997.

The consumption of diesel considered in over-counting was allocated to the road transport sector, with emissions from these gasoline consumption now estimated and reported in CRF category 1.A.3.b.

Differences are also identified for the years 2003 and 2004. Coincident with the introduction of colored and marked heating oil, the entry of this new category of diesel was responsible for incorrect allocations between the Commercial / institutional sector and the Agricultural sector, due to confusion between colored agricultural diesel and colored and marked diesel for heating.

The figure below compares fuel energy consumption for category 1.A.4 Other sectors. The differences found reflect the clarifications provided in the previous paragraphs.

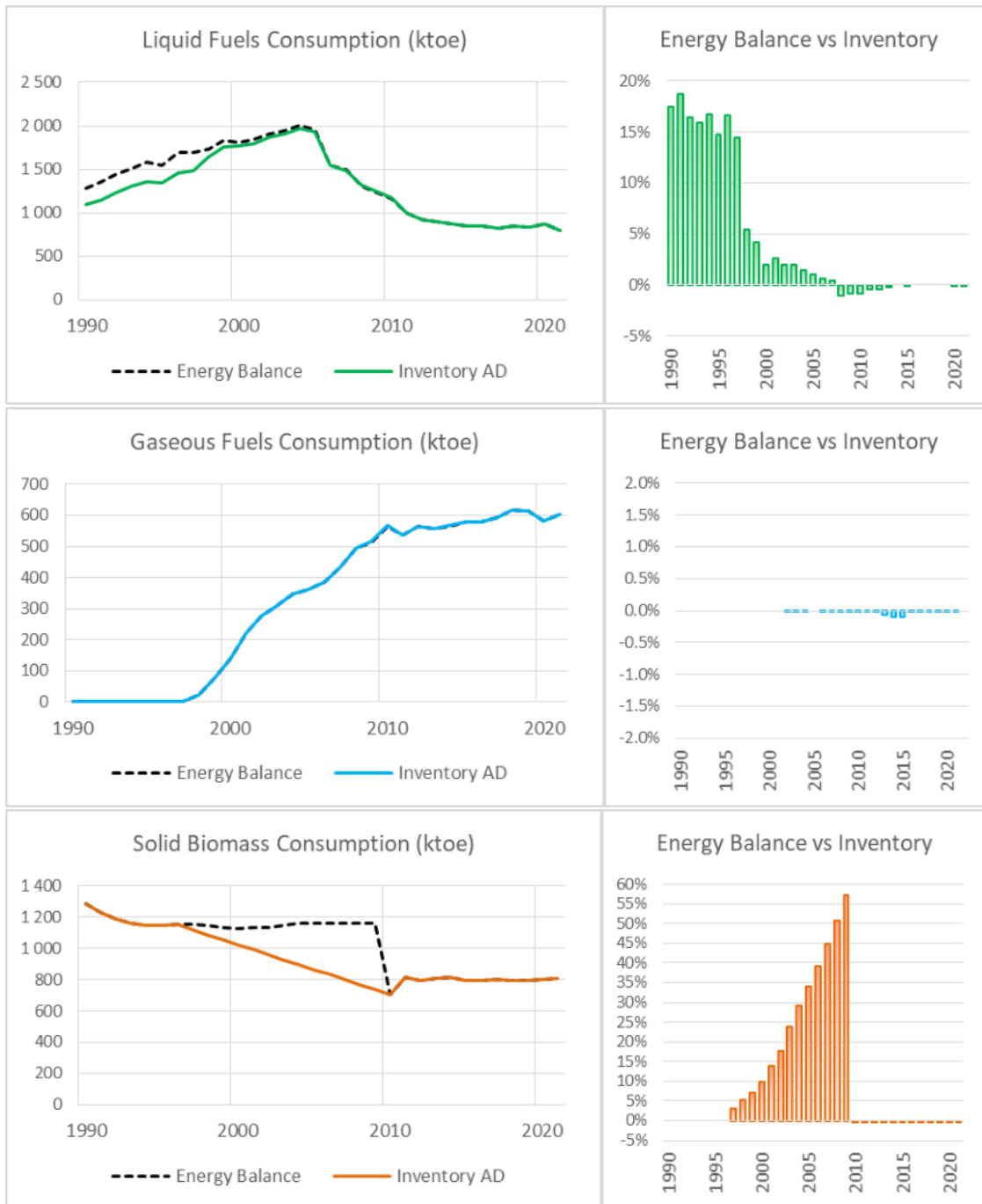

Figure 3-54: Energy consumption comparison between National Energy Balance and Inventory data by fuel type



3.6.7 Recalculations

There are no recalculations for category 1.A.4.

3.6.8 Further Improvements

Future improvements for this category include:

- Improvement of the consistency of energy consumption series. We intend to continue working together with the national authority responsible for producing the Energy Balance, to explain consumption trends and correct inconsistencies in the reporting and allocation of energy consumption. Currently, the consumption of biomass in the residential sector is identified as the main priority;
- Improve the detail in the Diesel consumption series, namely the separation between road diesels, agricultural diesel, heating diesel, also taking into account the different rates of incorporation of biodiesel in different types of diesel;
- Despite the great effort made during in past submissions to distribute the energy consumptions by the thermal uses and combustion equipment, it is our intention to improve this distribution of energy consumptions through the information being made available.



3.7 Other (Not Else-where specified) (CRF 1.A.5)

Emissions reported under category 1A5 refer to mobile military aviation. There is no information to disaggregate stationary emissions of military origin and therefore it is considered that these fuel consumption and associated emissions occur in category 1.A.4.ai Commercial, services and institutional and therefore the notation key "IE" - Included Elsewhere is applied to category 1.A.5.a.

3.7.1 Military Aviation (CRF 1.A.5.b)

3.7.1.1 Methodology

The energy balance does not provide a specific fuel consumption classification for military operations. Fuel consumed in military operations is reported under category "Serviços". Therefore emissions from military operations, except military aviation, are reported under category 1.A.4.ai Commercial, services and institutional. For military aviation it was assumed that all jet fuel reported under category "Serviços" was used for military aviation since jet fuel could be considered as an aviation specific fuel.

According with the IPCC Guidelines 2006, all the jet fuel for military operations was considered to be domestic since there is no information available regarding origins and destinies of the military aircraft movements that could be used to distinct domestic from international consumption.

3.7.1.2 Emission Factors

The emission factors used to estimate emissions are IPCC Guidelines 2006 default emission factors.

Table 3-87: Emission factors.

Fuel	CO ₂			CH ₄			N ₂ O		
	Value	Unit	Reference	Value	Unit	Reference	Value	Unit	Reference
Jet Fuel	71.5	tCO ₂ /TJ	IPCC 2006	0.5	kg/TJ	IPCC 2006	2.0	kg/TJ	IPCC 2006

3.7.1.3 Activity data

The following table shows the amount of jet fuel used for military operations provided by the national energy balance under the *Serviços* classification. All fuels under *Serviços* were already considered in the inventory besides jet fuel. Energy was estimated using a country specific LHV of 43.00 MJ/kg reported by the national energy authority.

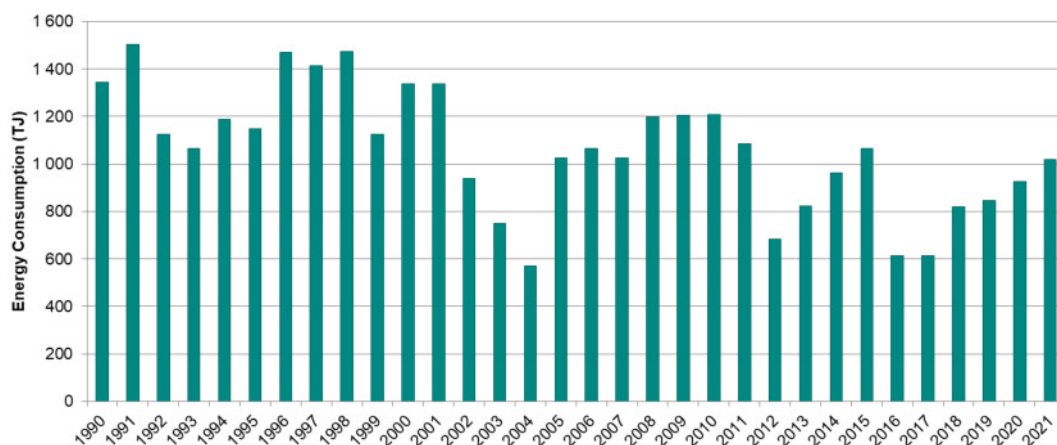

Figure 3-55: Energy Consumption in Military aviation.



The fluctuations in Jet Fuel consumption is related to the budget availability and frequency of training and missions of the military aviation activities.

3.7.1.4 Uncertainty Assessment

The uncertainty of fuel consumption was set equal to the uncertainty that was considered for road traffic: 5 %.

In a similar way, the uncertainties for emission factors used were the same as for road transportation: methane and nitrous oxide emission factors were set at 40 % and 50 % respectively. The general error of 5 % was used for the calculation of uncertainties of carbon dioxide emissions.

3.7.1.5 Recalculations

No recalculation were made.

3.7.1.6 Further Improvements

No further improvements are planned for this sector.



3.8 Fugitive Emissions from Fossil Fuels (CRF 1.B)

3.8.1 Solid Fuels: Coal Mining and Handling (CRF 1.B.1.a)

3.8.1.1 Category description

Coal contains some fraction of CO₂ and CH₄ trapped in its structure that is usually emitted to atmosphere during and after extraction of coal from surface mines. Emissions at extraction result from ventilation of mine gas which is done for safety reasons at underground mines. Post-mining emissions result from the slower liberation of CH₄ still entrapped in coal after it is extracted and stored at surface in piles, or from crushing and drying operations applied to modified and improve coal characteristics. In underground mines, post-mining emissions may occur in fact during extraction if degasification systems are installed but, nevertheless, total emissions remain more or less unaffected.

Portugal lacks coal exploration potential. Nonetheless, the main coal mining activities identified occurred in XIX and XX centuries, due to the two world wars, and were located in:

- Santa Susana Basin, in the south region;
- Mondego Basin, in the centre region;
- Vale do Lena Carboniferous Basin, in the centre region;
- Rio Maior Basin, in the centre region;
- Douro Carboniferous Basin, in the northwestern region.

In Santa Susana Basin, the main coal group mines was named Moinho da Ordem, of the underground type. The coal (bituminous coal) extraction began in 1839 and was latter closed down in 1944.

In Mondego Basin, the main coal group mines were located in Cabo Mondego and Buarcos group of underground mines. The coal (lignite) extraction began in 1750 and was latter closed down in 1967 due to a fire.

In Vale do Lena Carboniferous Basin, the main coal underground group mines were located in Porto de Mós and Batalha municipalities. The coal (lignite) extraction began around 1740, however, its operation has been inconstant over time and was latter closed down in 1959.

In Rio Maior Basin, the main coal group mines were located in Espadanal and Quinta da Várzea, of the underground type. The coal (lignite) extraction began in the early XX century and was latter closed down in 1970.

In Douro Carboniferous Basin, the main coal group mines were located in S. Pedro da Cova and Pejão. The coal extraction began in the XIX century, was latter closed down in 1992 and 1994, respectively, and did not resume activity since. Both groups of mines are of the underground type and are located in northern region of Portugal. Coal from these mines is classified as hard-coal (anthracite), it has a low energy value and it was used mainly as fuel for one public power energy plant near Porto (*Tapada do Outeiro* power plant). Moreover, the coal production during the exploration period was of small importance (less than 300 kt in 1990, see figure in Activity Data section).

Available information gathered states that all coal mines in Portugal were of the underground type.

From 1995 onwards all coal mines in Portugal were abandoned.

CO₂ and SO_x emissions from mining activity may occur when:

- burning of coal deposits occurs or;
- flaring is used to control air emissions or recover energy.



Because the occurrence of coal burning on-site or flaring is unknown for Portuguese mines, we assume these activities do not occur, hence, emissions of these pollutants from this source are not included in the inventory.

Emissions of CH₄ from abandoned mines may still continue after mine closure, even if mines are sealed.

Emissions from fuel consumption in coal extraction are included in category 1.A.2.g iii (see Section 3.3.2.2.1.2.15 Extractive Industry).

3.8.1.2 Methodology

Emission estimates include:

- CO₂ and CH₄ emissions from extraction of coal in the period 1990-onwards (mining);
- CH₄ emissions resulting from coal processing (post-mining);
- CH₄ emissions from abandoned underground mines (from 1901 onwards).

Emissions were estimated based on a Tier 1 approach for underground coal mines proposed in 2019 refinement to the 2006 IPCC Guidelines, which was considered sufficient given the scarcity of technical information concerning these mines and because this emission source is of small relevance (it was not identified as key category). There is no available data on CO₂ or CH₄ recovered from drainage, ventilation air, or abandoned mines in Portugal, so we assumed that none of these GHG is recovered and utilized for energy production or flared.

Mining related to underground coal mines

CO₂ and CH₄ emissions from mining were estimated according to the following equation:

$$Emi = EF_U^{ex} * Coal_U * CF * 10^{-3}$$

Where:

Emi: Emissions (t)

EF_U^{ex}: Emission factor for extraction in underground mining (m³/t)

Coal_U: Quantity of coal extracted from underground mines (t)

CF: Conversion factor - density of GHG at 20°C and atmospheric pressure (kg/m³)

Post-mining related to underground coal mines

CH₄ emissions related to these activities were estimated using the following equation:

$$Emi_{CH_4} = EF_U^{post} * Coal_U * CF * 10^{-3}$$

Where:

Emi_{CH₄}: Methane emissions (t)

EF_U^{post}: Emission factor for post-extraction emissions in underground mining (m³/t)

Coal_U: Quantity of coal extracted from underground mines (t)

CF: Conversion factor - the density of methane at 20°C and atmospheric pressure (0.67 x 10⁻⁶ Gg/m³)



Abandoned underground coal mines

To estimate CH₄ emissions related to this item, it was applied a Tier 1 approach proposed in equation 4.1.10 of 2006 IPCC Guidelines:

$$Emi_{CH_4} = Number_{ACM} * f_{GCM} * EF * CF * 10^3$$

Where:

Emi_{CH₄}: Methane emissions (t)

Number_{ACM}: Number of abandoned coal mines remaining unflooded (number)

f_{GCM}: Fraction of gassy Coal Mines (adimensional)

EF_{CH₄}: CH₄ emission factor for abandoned underground mines (10⁶ m³ CH₄/mine)

CF: Conversion factor - the density of methane at 20°C and atmospheric pressure (0.67 x 10⁻⁶ Gg/m³)

3.8.1.3 Emission Factors

Mining and Post-mining related to underground coal mines

According to 2006 IPCC Guidelines, countries using Tier 1 approach should consider country-specific variables such as the depth of major coal seams to determine the CH₄ emission factor to be used. Available information states that both Pejão and S. Pedro da Cova group of underground mines (the only ones that remain active in the period 1990-1994) had around 420/450 m depth, hence, the higher default emission factors were used for both mines, which are presented in the table below (Chapter 4.1.3.2 Volume 2 of the 2006 IPCC Guidelines).

According to Chapter 4.1.3.2 of the 2019 Refinement to the 2006 IPCC Guidelines, countries should use the Average CO₂ Emission Factor unless there is country-specific evidence to support use of an alternative factor within the low/high range. Therefore, given that there is no available information at national level, the average EF for CO₂ (5.9 m³/ton) was applied.

Table 3-88: Emission Factors for coal extraction and processing

Parameter	Type of Emission	Emission Factor	Value	Unit	Source
CH ₄	Extraction	EF _{U^{ex}}	25	m ³ /ton	2006 IPCC Guidelines
	Post-mining	EF _{U^{post}}	4.0	m ³ /ton	
CH ₄ density	-	CF	0.67	kg/m ³	
CO ₂	Extraction	EF _{U^{ex}}	5.9	m ³ /ton	2019 Refinement to the 2006 IPCC Guidelines
CO ₂ density	-	CF	1.84	kg/m ³	

Abandoned underground coal mines

One of the parameters for this item is the total number of abandoned mines in each time band since 1901 remaining unflooded. According to 2006 IPCC Guidelines, if there is no knowledge on the extent of flooding it is good practice to assume that 100 % of mines remain unflooded. In Portugal there is no available data concerning mines that remain unflooded. The table below identifies the total number of abandoned mines in each time band since 1901.

**Table 3-89: Total number of abandoned mines in each time band since 1901**

Time Interval	No. abandoned mines
1901-1925	0
1926-1950	1
1951-1975	3
1976-2000	2
2001-Present	0
TOTAL	6

Given that there is no available data concerning mines that, when were actively producing coal, were considered gassy, the fraction of gassy coal mines was estimated assuming the average values for abandoned underground mines, provided in Table 4.1.5 of Chapter 4 of Volume 2 of the 2006 IPCC Guidelines.

Table 3-90: Percentage of abandoned underground coal mines that are gassy

Time Interval	Unit	2006 IPCC Range		
		Low	High	Medium value
1901-1925	%	0	10	5
1926-1950	%	3	50	26.5
1951-1975	%	5	75	40
1976-2000	%	8	100	54
2001-Present	%	9	100	54.5

The CH₄ emission factors for abandoned underground mines were obtained from the updated Table 4.1.6 of Chapter 4 of 2019 Refinement to the 2006 IPCC Guidelines.

3.8.1.4 Activity data

The activity data for mining and post-mining activities is the amount of coal extracted.

For mining and post-mining activities from 1990-onwards we considered the only two coal mines still active in Portugal (specifically, in the period 1990-1994), both of the underground type. The amount of coal extracted decreased towards the final closure of both mines in 1993 and 1994, respectively, as may be seen in the figure below. Statistical information on the amount of coal extracted was obtained from Geological Resources reports from DGEG.

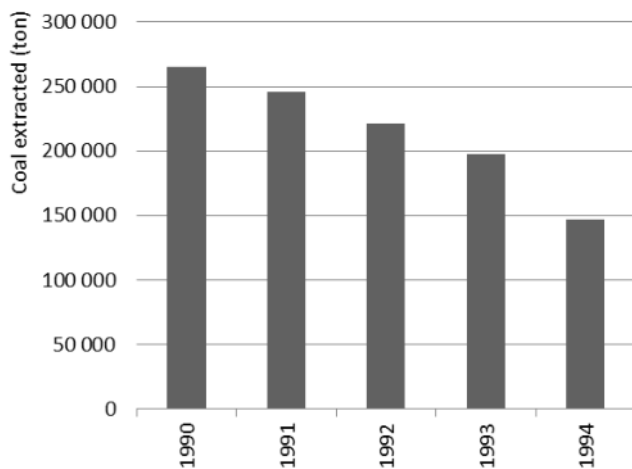
**Figure 3-56: Amount of coal extracted from mines in Portugal**



The activity data for abandoned underground mines is the number of abandoned underground coal mines (or group of mines), as mentioned in section 3.3.6.1.1.3 Emission Factors, Table 3.132, obtained from LNEG.

In CRF tables, activity data for underground mines (Table 1.B.1, category 1.B.1.a.i) is the amount of fuel produced. However, from 1995 onwards all coal mines in Portugal were abandoned, hence, no amount of fuel produced. Furthermore, the activity data for abandoned underground mines (in the period 1995-onwards there are only abandoned underground mines) is the number of abandoned underground coal mines (or group of mines). For these reasons, for the period 1995-onwards the AD is reported as NO.

3.8.1.5 Uncertainty Assessment

A value of 5 % was considered for the uncertainty of coal production (activity data) which is a conservative factor according to the proposed values by IPCC (2000). Also in accordance with table 2.14 of the GPG, the uncertainty values for CH₄ emission factors were set at 100 % for underground mines. The uncertainties in CO₂ emission factors were set equal to uncertainties of CH₄ emission factors, considering that CO₂ emissions are simply atmospheric conversion of methane emissions.

3.8.1.6 Recalculations

No recalculations were made.

3.8.1.7 Further Improvement

No further improvements are planned for this sector.



3.8.2 Solid fuels: Solid fuel transformation (CRF 1.B.1.b)

3.8.2.1 Category description

Metallurgical Coke was produced in the coke plant of the integrated iron and steel facility that existed from 1990 to 2001. This category includes CH₄ fugitive emissions from coke production in the coke plant. We assumed no flaring in coke production. Detailed info regarding all emission streams for iron and steel operations, as well as the categories under which emissions are reported can be found in Table 4-37 and section 4.4.2.1 of the IPPU chapter.

3.8.2.2 Methodology

CH₄ fugitive emissions from coke production were estimated based on a Tier 1 production approach of the 2019 Refinement to the 2006 IPPC Guidelines, according to the following equation:

$$Emi_{CH_4} = EF_{CH_4} \times Coke_{Prod} \times 10^{-3}$$

Where:

Emi_{CH₄}: CH₄ fugitive emissions (t)

EF_{CH₄}: CH₄ emission factor (kg/t coke)

Coke_{Prod}: Quantity of coke produced (t)

3.8.2.3 Emission Factors

CH₄ emission factor for coke production in the period 1990-2001 applied was 0.049 kg/ton coke and was taken from Table 4.3.5 of the 2019 Refinement to the 2006 IPPC Guidelines.

3.8.2.4 Activity data

Annual coke production was obtained from DGEG (Coke plant Balance) from 1990 to 2001. From 2002 onwards, there is no coke production in the iron and steel industry in Portugal.

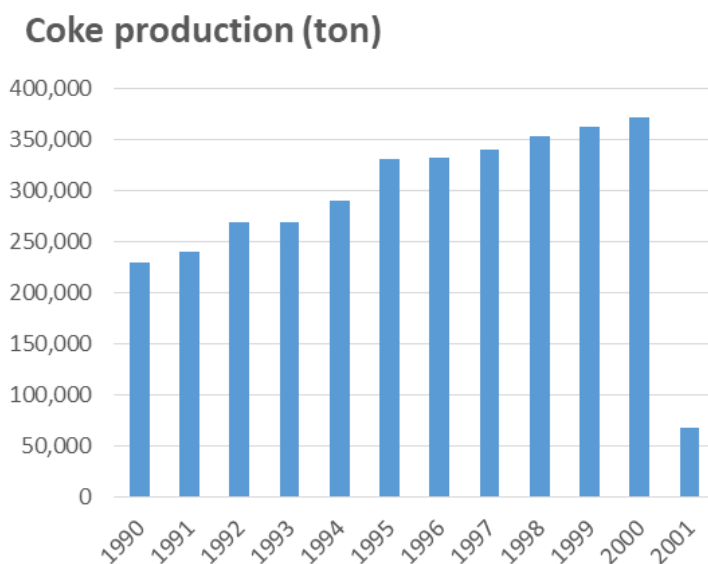

Figure 3-57: Coke production in the coke plant



3.8.2.5 Uncertainty Assessment

A value of 5 % was considered for the uncertainty of coke production (activity data). CH₄ emission factor was set at 100 %.

3.8.2.6 Category specific QA/QC and verification

QA/QC procedures included a series of checks: calculation formulas verification, data and parameters verification and the information provided in this report. QA/QC procedures to the coke production process indicated a compilation error associated with CO₂ fugitive emissions. These emissions were being miscalculated and were removed.

3.8.2.7 Recalculations

No recalculations were made.

3.8.2.8 Further Improvement

No further improvements are planned for this sector.



3.8.3 Oil and natural gas and other emissions from energy production: Oil (CRF 1.B.2.a)

3.8.3.1 Category description

Extraction and production of crude oil never occurred in the Portuguese territory. Therefore, fugitive emissions are related to those resulting from refining, storage and transport of crude oil, other raw materials, intermediate products and final products - particularly gasoline - from terminal receiving of crude oil and other petroleum products till delivering to final consumer. According to available methodologies air emissions considered include:

- Marine Terminals and Ballast water;
- Emissions from refinery operations not including emissions from combustion of fuels, such as: Flaring and venting in oil refining and;
- Emissions due to storage of raw materials, intermediate products and final products in the refinery;
- Emissions from refinery dispatch station;
- Emissions from the transport and distribution of petroleum products in the Portuguese Territory, including transport depots and service stations.

3.8.3.2 Exploration (CRF 1.B.2.a.1)

There is no oil exploration in Portugal.

3.8.3.3 Production (CRF 1.B.2.a.2)

There is no crude oil production in Portugal.

3.8.3.4 Transport (CRF 1.B.2.a.3)

3.8.3.4.1 Category description

In 1990 there were three oil refining plants in Portugal: Porto, Lisbon and Sines. After 1993, the Lisbon unit was closed. Porto has terminated its refining activities in April 2021. Only Sines unit remains in operation.

Emissions from this source consist mainly of volatile organic compounds, including methane, that escape to atmosphere during transport of crude oil to refineries for processing. The three oil refineries considered in the inventory were all located at a small distance from the sea coast. Crude oil is received near refineries by sea tankers and transported directly to each refinery by small connecting pipelines.

3.8.3.4.2 Methodology

CO₂ and CH₄ emissions were estimated according to the following equation:

$$Emis_{CO_2} = \frac{(Crude_{cons} \times EF_{CO_2})}{1 \times 10^6}$$

Where:

Emi_p: GHG p emissions (kt)

Crude_{cons}: Crude received in refineries (m³)

EF_p: GHG p emission factor (kg/m³)



3.8.3.4.3 Emission Factors

Table 3-91: Emission Factors

Parameter	Unit	Emission Factor	Source
CO ₂	kg/m ³ crude	4.9 x 10 ⁻⁷	Table 4.2.4 of Volume 2: Energy of 2006 IPCC Guidelines for National Greenhouse Gas Inventories (Developed Countries; Category: Oil Transport; Sub-category: Pipelines)
CH ₄	kg/ 1000 m ³ crude	5.4 x 10 ⁻³	Table 4.2.4 of Volume 2: Energy of 2006 IPCC Guidelines for National Greenhouse Gas Inventories (Developed Countries; Category: Oil Transport; Sub-category: Pipelines)

3.8.3.4.4 Activity data

Activity Data reported under this subcategory concerns crude that arrives in marine terminals, before being consumed in the refineries, and is presented in the figure below. In the period 1990 to 2004, data on crude received was obtained from DGEG. From 2005 onwards, data was obtained from refineries.

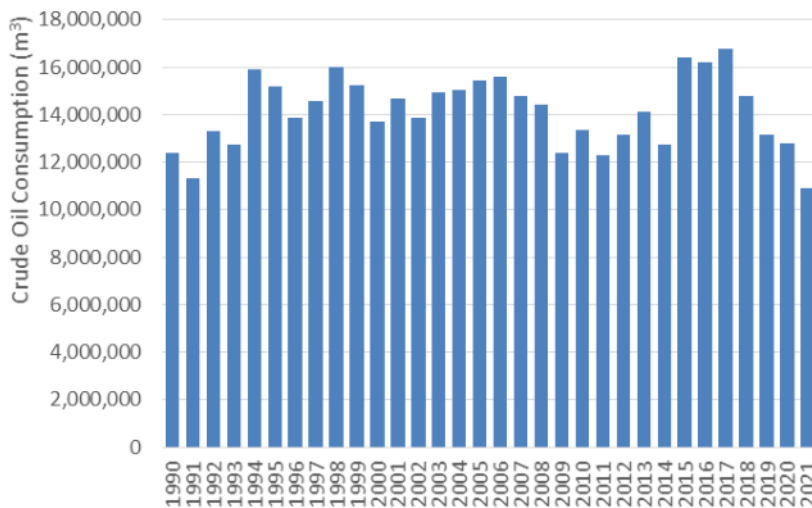

Figure 3-58: Total amount of crude arriving in Marine Terminals

3.8.3.4.5 Uncertainty Assessment

An uncertainty value (3 %) similar to that that was considered for fuel consumption data in industrial LPS was also used for quantification of uncertainty of activity data for this source sector reflecting the fact that in this case data was also collected directly from refinery plants, where crude oil is uploaded, and used to build the energy balance of DGEG. The uncertainty of CO₂ emissions was considered to be 50 %, which is the double (conservative approach) of the value proposed in chapter 2.7 of GPG for high quality emission factors for most gases.

3.8.3.4.6 Recalculations

No recalculations were made.

3.8.3.4.7 Further Improvement

No further improvements are planned for this sector.



3.8.3.5 Refining and Storage (CRF 1.B.2.a.4)

3.8.3.5.1 Category description

In 1990 there were three oil refining plants in Portugal: Porto, Lisbon and Sines. After 1993, the Lisbon unit was closed. Porto has terminated its refining activities in April 2021. Only Sines unit remains in operation.

The refining process converts crude oil - which is a complex mixture of hydrocarbon compounds with impurities of sulphur, nitrogen, oxygen and heavy metals - into oil products used as fuels, asphalts, lubricants or feedstock for the organic and inorganic chemical industry. Processes included in Portuguese refineries include:

- Separation process: isolation of individual constituents of crude using differences in boiling-point, using atmospheric and vacuum distillation and recovery of light end gases;
- Conversion process. These may be also classified as:
 - Cracking - Chemical transformation of separated fractions breaking molecules of heavy molecular weight into smaller ones, including visbreaking;
 - Polymerization of small molecules combined in bigger molecules with different characteristics. Alkylation has similar purposes;
 - Chemical transformations that change molecular structure such as Isomerization, reforming and asphalt blowing;
- Treatment processes. Operations which include hydrodesulphurization, hydrotreating, chemical sweetening, acid gas removal, deasphalting and desalting, that are used to remove impurities, the most important is sulphur;
- Blending of individual fractions and intermediate products to obtain final commercial products with characteristics as desired.

Emissions of storage of crude oil and other materials, intermediate products and final products are also included in this source sector as they are fugitive emissions occurring as part of the refining process. Because emissions from organic liquids in storage occur both from the evaporative loss of the liquid as well as from changes in the liquid level, the emission sources vary significantly with tank design. Six basic tank designs are usually used for organic liquid storage vessels: fixed roof (vertical and horizontal), external floating roof, domed external (or covered) floating roof, internal floating roof, variable vapour space, and pressure (low and high).

NMVOC and CH₄ emissions may also result from “normal” leaks²³ scattered through the refinery site in pneumatic devices such as valves, failure of connections, flanges, pump and compressor shafts, seals and instruments. Release of gases may also follow system failure, that usually occurs during unplanned events, such as sudden pressure surge from failure of a pressure regulator, and pressure relief systems that protect the equipment from damage. In Portuguese refineries, pressure relief systems are usually connected to collection system and transported to a flare. There may be also NMVOC emissions resulting from non-condensable fraction at the steam ejectors or vacuum pumps of the Vacuum distillation. Emissions in flares are discussed in “Venting and Flaring in Oil Industry” below.

Use of some catalytic converters, such as Fluid Catalytic Cracking and Platforming units, are used to convert heavy oils into lighter products, by action of heat, pressure and catalysts. Fluidized-bed Catalytic Cracking (FCC) use finely divided catalysts suspended in a riser with hot vapour from the fresh feed.

²³ Sometimes only these emissions are referred as fugitive emissions from refineries.



Catalytic processes result in operations emissions, when the coke that is deposited in the catalytic bed over time has to be burned in the regenerator equipment. Emissions from catalyst regeneration are also included in this source category.

3.8.3.5.2 Fluid Catalytic Cracking (FCC)

3.8.3.5.2.1 Methodology

CO₂ emissions were estimated according to the following equation:

$$Emi = \text{Coke}_{\text{cons}} \times EF_{\text{CO}_2} \times 10^{-3}$$

Where:

Emi: CO₂ emissions (kt)

Coke_{cons}: Coke burned in fluid catalytic cracking (t coke)

EF_{CO₂}: CO₂ emission factor (t CO₂/t coke)

3.8.3.5.2.2 Emission Factors

CO₂ emission factor was obtained from EU-ETS and is presented in the table below.

Table 3-92: CO₂ emission Factor

Pollutant	Unit	EF
CO ₂	t CO ₂ /t coke	3.25-3.44

3.8.3.5.2.3 Activity Data

There is only one refinery with a fluid catalytic cracking unit in Portugal since 1994. Given so, we present data in the figure below as an index value related to the amount of coke burned in 1994.

From 2005 onwards, the amount of coke burned was obtained from EU-ETS. From 1994 to 2004 we use data provided by the refinery on coke burned in fluid catalytic cracking unit.

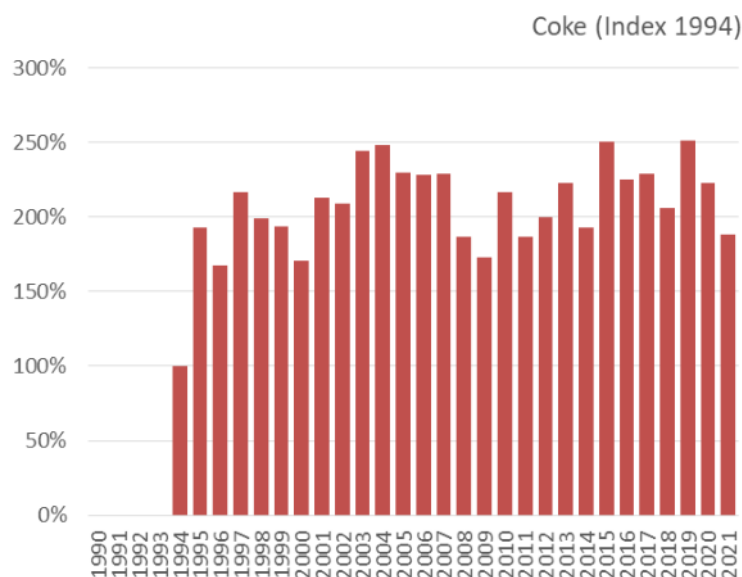

Figure 3-59: Coke burned in the Fluid Catalytic Cracking Unit



3.8.3.5.2.4 Uncertainty Assessment

Most of the activity data that was obtained to estimate emissions comes directly from the refinery units. Therefore a low uncertainty of 3 % may be assumed for this sub-source in a similar mode to other LPS combustion data.

Uncertainty of emission factors for CO₂ were set as 50 %, at the higher range of possible uncertainties proposed by IPCC (2000), although the fact that some emission factors use plant specific information.

3.8.3.5.2.5 Recalculations

No recalculations were made.

3.8.3.5.2.6 Further Improvement

No further improvements are planned for this sector.

3.8.3.5.3 Platforming/Continuous Catalyst Regenerators (CCR)

3.8.3.5.3.1 Methodology

CO₂ emissions were estimated according to the following equation:

$$Emi = Coke_{cons} \times EF_{CO_2} \times 10^{-3}$$

Where:

Emi: CO₂ emissions (kt)

Coke_{cons}: Coke burned in continuous catalyst regeneration (t coke)

EF_{CO₂}: CO₂ emission factor (t CO₂/t coke)

3.8.3.5.3.2 Emission Factors

CO₂ emission factors were obtained from EU-ETS from Sines refinery and regeneration of catalysts at Porto refinery.

Table 3-93: CO₂ emission factors

Pollutant	Unit	EF
CO ₂	t CO ₂ /t coke	3.63-3.66

3.8.3.5.3.3 Activity Data

Porto has terminated its refining activities in April 2021. Only Sines unit remains in operation.

Data regarding coke burned in Platforming/Continuous Catalyst Regenerators was provided by the refineries and is presented in the figure below.

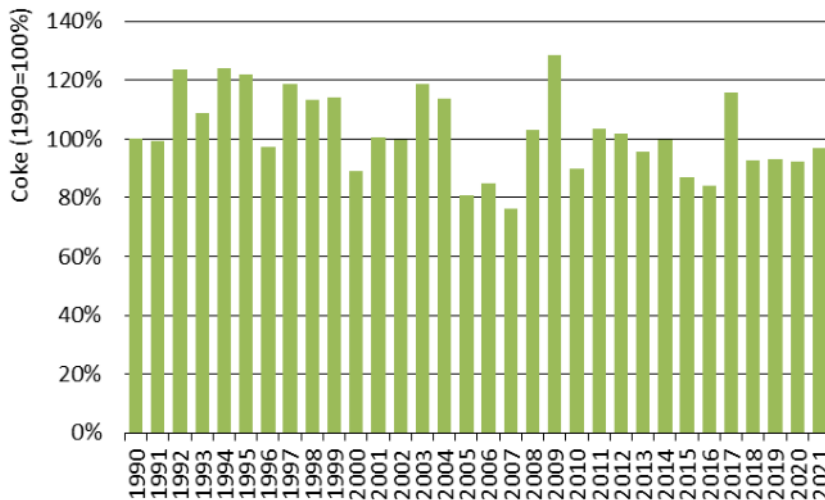

Figure 3-60: Coke burned in Platforming/Continuous Catalyst Regeneration (CCR)

3.8.3.5.3.4 Uncertainty Assessment

Most of the activity data that was obtained to estimate emissions comes directly from the refinery units. Therefore a low uncertainty of 3 % may be assumed for this sub-source in a similar mode to other LPS combustion data.

Uncertainty of emission factors for CO₂ were set as 50 %, at the higher range of possible uncertainties proposed by IPCC (2000), although the fact that some emission factors use plant specific information.

3.8.3.5.3.5 Recalculations

No recalculations were made.

3.8.3.5.3.6 Further Improvements

No further improvements are planned for this sector.

3.8.3.5.4 Hydrogen production in the Steam Reformer

3.8.3.5.4.1 Methodology

Only Sines refinery has Hydrogen units. There are two Hydrogen Production Units in Sines: one began in 2004 (in pilot phase during 2004 and full operation from 2005 onwards) and produces the hydrogen required to the desulphurisation of gas oils and gasolines; the other one began in 2013 and produces the hydrogen required for the hydrocracking unit. They both remain in operation ever since.

CO₂ emissions from Hydrogen production in the Steam Reformers were estimated according to the following equation:

$$Emi = Fuel_{cons} \times EF_{CO_2} \times 10^{-3}$$

Where:

Emi: CO₂ emissions (kt)

Fuel_{cons}: Fuel consumption in steam reformers (t fuel)

EF_{CO₂}: CO₂ emission factor (t CO₂/t fuel)



3.8.3.5.4.2 Emission Factors

CO₂ emission factors applied to fuel consumption in the steam reformer units in Sines refinery were obtained from EU-ETS from 2005 onwards and are indicated in the table below.

Table 3-94: CO₂ emission factors

Pollutant	Unit	EF
CO ₂	t CO ₂ /t fuel	2.75-2.80

3.8.3.5.4.3 Activity Data

These units use natural gas as input. 2004 fuel consumption data was obtained directly from the facility. From 2005 onwards, fuel consumption in the steam reformers is obtained from EU-ETS data.

Given that there is only one refinery producing hydrogen in steam reformer units, due to confidentiality constrains, data is presented in the figure below as an index related to 2004 fuel consumption value. From 1990 to 2003 there was no hydrogen production unit operating. From 2013 onwards fuel consumption increases significantly due to the entry into full operation of the new hydrocracking unit in 2013.

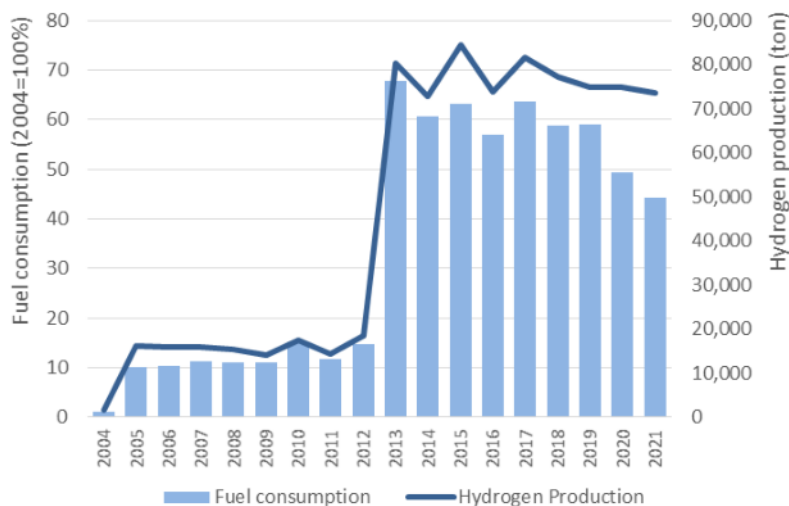

Figure 3-61: Fuel consumption and Hydrogen production in the hydrogen steam reformers

3.8.3.5.4.4 Uncertainty Assessment

Both activity data and CO₂ emission factors used to estimate emissions come directly from the refinery facility, therefore, a low uncertainty of 3 % may be assumed for this sub-source in a similar mode to other LPS combustion data.

3.8.3.5.4.5 Recalculations

No recalculations were made.

3.8.3.5.4.6 Further Improvements

No further improvements are planned for this sector.

3.8.3.5.5 Oil-Water collection and treatment systems

3.8.3.5.5.1 Category description

There are only indirect CO₂ emissions related to NMVOC emissions. Please check Portugal IIR for NMVOC emissions estimates.



3.8.3.5.6 Storage Tanks

3.8.3.5.6.1 Category description

Regarding Storage tanks, there are only indirect CO₂ emissions related to NMVOC emissions.

In order to estimate NMVOC emissions from this category, it was used Total throughput from storage and tanks in each refinery as activity data. Total throughput represents not only crude oil entered into the refinery (which constitutes the activity data for category 1.B.2.a.3) but also other petroleum products that are imported or moved between refineries.

Since in this category there are only indirect CO₂ emissions related to NMVOC emissions, information on the activity data, methodology and emission factors is provided in the Portuguese 2020 IIR submission.

3.8.3.5.7 Fugitive emissions from oil refining/storage

3.8.3.5.7.1 Category description

Emissions from this source consist mainly of methane, that escapes to atmosphere during refining and transport operations. Crude oil is refined and stored in each of the three oil refineries existing in Portugal.

3.8.3.5.7.2 Methodology

CH₄ emissions were estimated according to the following equation:

$$Emi_{CH_4} = \frac{(Crude_{cons} \times EF_{CH_4})}{10^6}$$

Where:

Emi_{CH₄}: CH₄ emissions (t)

Crude_{cons}: Crude throughput in refineries (m³)

EF_{CH₄}: CH₄ emission factor (Gg/10³ m³)

3.8.3.5.7.3 Emission Factors

Given that there is no available data concerning plant or country specific emission factors for fugitive emission from oil refining and storage, CH₄ fugitive emission factor was estimated assuming the average value of the range provided in Table 4.2.4 of Chapter 4 of Volume 2 of the 2006 IPCC Guidelines for Developed Countries (Category: Oil Refining; Sub-category: All).

Table 3-95: CH₄ emission factor for fugitive emissions in oil refining

Parameter	Unit	2006 IPCC Range		Medium value
		Low	High	
CH ₄	Gg/10 ³ m ³ oil refined	2.6 x 10 ⁻⁶	41.0 x 10 ⁻⁶	2.18 x 10 ⁻⁵

The emission factor provided by the 2006 IPCC Guidelines is related to the amount of oil refined, however, we assumed that all crude throughput arriving at the refineries is refined. Therefore, the activity data used was crude throughput in the refineries, in m³.



3.8.3.5.7.4 Activity data

Data on crude throughput was obtained from refineries for the whole time series.

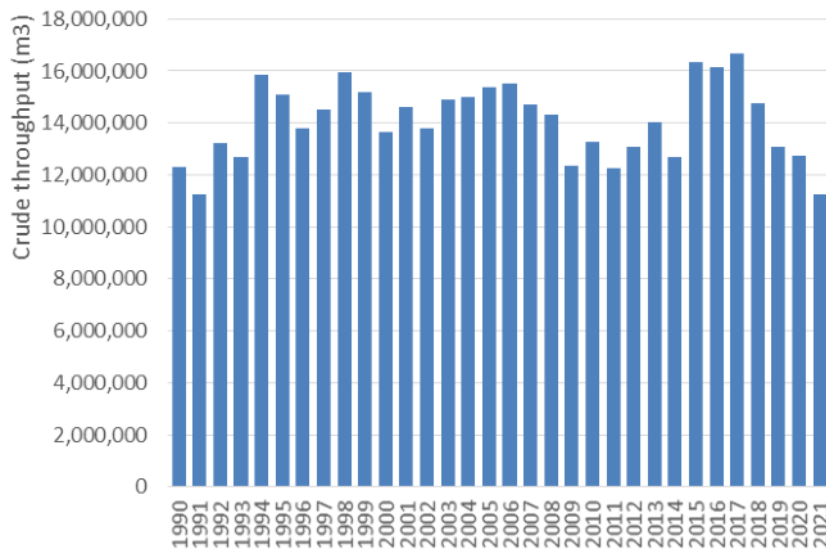

Figure 3-62: Total amount of crude throughput

3.8.3.5.7.5 Uncertainty Assessment

Most of the activity data that was obtained to estimate emissions comes directly from the refinery units. Therefore a low uncertainty of 3 % may be assumed for this sub-source in a similar mode to other LPS combustion data.

Uncertainty of emission factors for CH₄ were set as 50 %, at the higher range of possible uncertainties proposed by IPCC (2000).

3.8.3.5.7.6 Recalculations

No recalculations were made.

3.8.3.5.7.7 Further Improvement

No further improvements are planned for this sector.

3.8.3.6 Distribution of Oil Products (CRF 1.B.2.a.5)

3.8.3.6.1 Category description

This sub-source sector includes emissions from distribution of refinery products, mainly gasoline in:

- (1) Terminal Dispatch Stations in Refineries. Emissions of volatile organic compounds occurring inside refineries during filling of transport vehicles - trucks, rail cars - when dispatching products of the refining unit. Most emissions occur when light products with high level of volatile compounds are dispatched;
- (2) Transport and Depots, occurring in storage tanks outside the refineries and over the country;
- (3) Service Stations, including emissions from tank loading from trucks and when refuelling consumer cars.



Emissions may result from:

- Leakage. Evaporation of liquid products by flaws and seal leakage, pumps and valve systems;
- Displacement emissions, due to displacement of air in tanks by the incoming liquid;
- Breathing emissions in tanks;
- Vapours emitted when filling vehicles in result of displacement of filling air and from splashing and turbulence during filling;
- Unwanted spillage.

There are only indirect CO₂ emissions related to NMVOC emissions. Please check Portugal IIR for NMVOC emissions estimates.



3.8.4 Oil and natural gas and other emissions from energy production: Natural Gas (CRF 1.B.2.b.)

3.8.4.1 Category description

There is no production of natural gas in Portugal. The use of natural gas in Portugal was initiated only in 1997 (DGEG). At that time this energy source was received by ship from Algeria and used mainly in electric power production and in combustion in industry. Since then its use has become more widespread and it is now consumed also in the manufacturing industry, domestic, service, institutions, commerce, building and construction, agriculture and even a small quantity in road transport. All natural gas is imported and received through shipping transport from Algeria and Nigeria as Liquefied Natural Gas (LNG). There are also no major processing operations in Portugal.

Natural gas pipelines may be classified in two different sub-groups:

- Transmission lines. Operating at high pressure, are used to transport natural gas in bulk over large distances till distribution centres;
- Distribution networks. Comprehend the network of extensive pipelines that convey natural gas to the end-user. They tend to work on lower pressure and with smaller diameter lines. There are distribution networks of natural gas distributing for industrial consumers, services and domestic users.

The gas received from Algeria in ships is re-gasified in a plant in Sines, in southern Portugal.

Methane emissions from natural gas result mostly from leaks of unmodified natural gas, in pipes or in the plant. Although these losses happen as result of maintenance operations or abnormal accident situations (pressure surges due to failure of equipment that controls pressure), they occurs also constantly as result of normal operations of the system in operation valves or in chronic leaks due to seal failure, flawed valves, small cracks and holes in the lines or reservoirs.

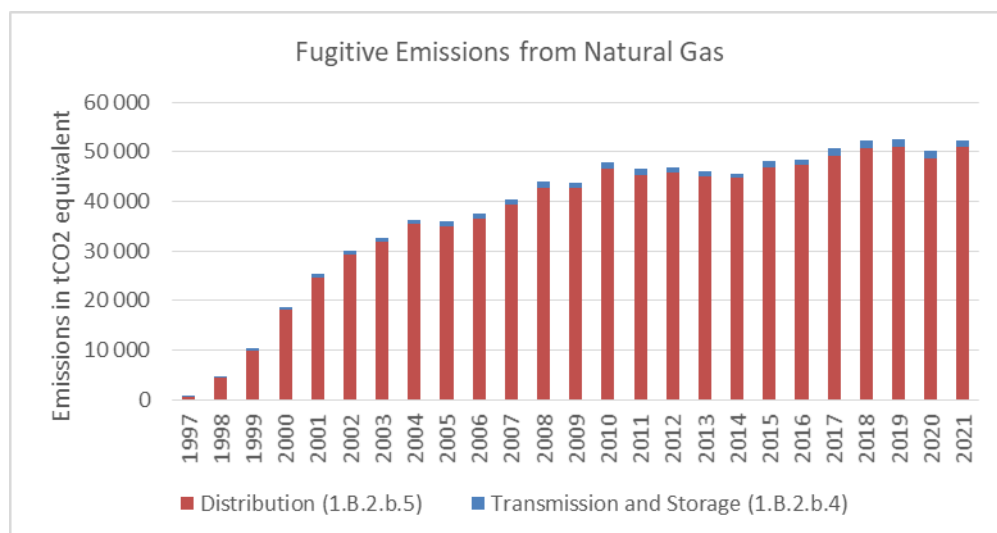

Figure 3-63: Fugitive Emissions from Natural Gas

3.8.4.2 Methodology

Estimates of fugitive emissions related to the transport of natural gas are separated into two categories. One relates to fugitive emissions during transport of Natural Gas to High Pressure and is reported in code CRF



1.B.2.b.4. - Transmission and Storage. The other refers to the distribution networks operating medium and low pressure, these are reported in code CRF *1.B.2.b.5. – Distribution.*

Losses of natural gas through leaks are estimated through adjustment factors published by ERSE - National regulatory body of the Natural Gas market. This adjustment factors are published to estimate own consumption and leakage occurring along the national natural gas network. Including:

- National Natural Gas Transportation Network - (Leakage during maintenance interventions, or resulting from incidents affecting the infrastructure)
- Reception, storage and regasification terminals for Natural Gas Liquid - (Purges and natural gas burning)
- Underground Storage (mostly own consumption)
- Distribution networks (gas released in safety valves, incident on distribution networks).

The CO₂ and CH₄ emissions are estimated taking into account the composition of Natural Gas imported by Portugal.

Transmission and Storage (1.B.2.b.4)

The adjustment factor considered for the National Natural Gas Transportation Network at High Pressure simultaneously considers the transmission processes and storage processes.

In order to obtain the amount of Natural Gas circulating in a year in the National High-Pressure Natural Gas Transport Network, it is necessary to remove from the total imported NG the one that arrives in the country via trucks directly to autonomous units that intrude the gas directly into the networks of distribution.

NG Transmission Network HP = NG Imported – NG from Autonomous units

NG Transmission Network Leaks = NG Transmission Network HP * Adjustment Factor HP

Transmission CH₄ Fugitive Emissions = NG Transmission Network HP Leaks * % of CH₄ in National NG

Transmission CO₂ Fugitive Emissions = NG Transmission Network HP Leaks * % of CO₂ in National NG

Distribution (1.B.2.b.5)

ERSE publishes differentiated adjustment factors for medium and low pressure distribution networks. Thus the natural gas consumptions reported in the energy balance were divided according to the type of supply network.

NG Distribution Network Leaks = NG Distribution MP Leaks + NG Distribution LP Leaks

The quantities of Natural Gas distributed by the two types of network are obtained through the Energy balance, which differentiates consumption by sector. Therefore:

NG Distribution Medium Pressure: Manufacturing industries

NG Distribution Low Pressure: Residential, Services, Commercial, Agriculture & Fisheries

The amount of natural gas leaks is estimated as follows:

NG Distribution LP Leaks = NG Distribution MP * Adjustment Factor MP

NG Distribution MP Leaks = NG Distribution HP * Adjustment Factor LP

Distribution CH₄ Fugitive Emissions = NG Transmission Distribution Leaks * % of CH₄ in National NG

Distribution CO₂ Fugitive Emissions = NG Transmission Distribution Leaks * % of CO₂ in National NG



3.8.4.3 Emission Factors

The adjustment factors for losses and self-consumption are applied for the purpose of determining the quantities of natural gas that market agents must place at the entrance of the Portuguese Natural Gas Network infrastructures, in order to guarantee the delivery of the natural gas necessary to supply the expected consumption for the Customers. These adjustment factors derived from the losses and self-consumption recorded by the different operators.

Table 3-96: Adjustment Factor for Natural Gas Leaks

Adjustment Factor	Value	Unit
Leaks in Natural Gas Transportation Network (high pressure)	0.0015	% of Natural Gas Transmitted
Leaks in Natural Gas Distribution Network (medium pressure)	0.07	% of Natural Gas Distributed (med)
Leaks in Natural Gas Distribution Network (low pressure)	0.34	% of Natural Gas Distributed (low)

The leakage values in the high pressure transport network are low because in this system the total losses are marginal (0.11% of all Natural Gas transmitted) and only a small part are NG leaks (1.33% of all losses), the remaining losses are self-consumption that are considered in the chapter of the combustion of energy.

In the NG distribution network, leaks are associated with leaks in mechanical elements such as valves, purges, reduction stations, reduction and counting stations, mechanical connections, etc. In addition, losses are also associated with the network operation resulting from the purge for commissioning of new sections, the commissioning of new customers, gas emissions into the air resulting from the operation of safety systems, network maintenance operations, etc.. Also included in the technical losses are the possible leakages of natural gas, in the particular installations of the consumers, upstream of the meters.

The verification of natural gas characteristics is carried out by ORT - Transmission System Operator (REN Gasoduto), which periodically publishes the parameters on reference natural gas distributed in Portugal. The final composition of the natural gas varies according to its provenance and mixture, and the national average values are presented according to the following table.

Table 3-97: Characteristics of natural gas

	Unit	value
Methane	mole %	90.05
Ethane (COVNM)	mole %	6.45
Propane (COVNM)	mole %	1.74
i-butane (COVNM)	mole %	0.23
n-butane (COVNM)	mole %	0.27
i-pentane (COVNM)	mole %	0.02
n-pentane (COVNM)	mole %	0.01
n-hexane (COVNM)	mole %	0.01
Nitrogen	mole %	0.58
CO2	mole %	0.63



3.8.4.4 Activity data

According to the above explained methodology, activity data comprehends:

- Imports of natural gas, obtained from the DGEG's Energy Balances;
- Consumption of Natural Gas.

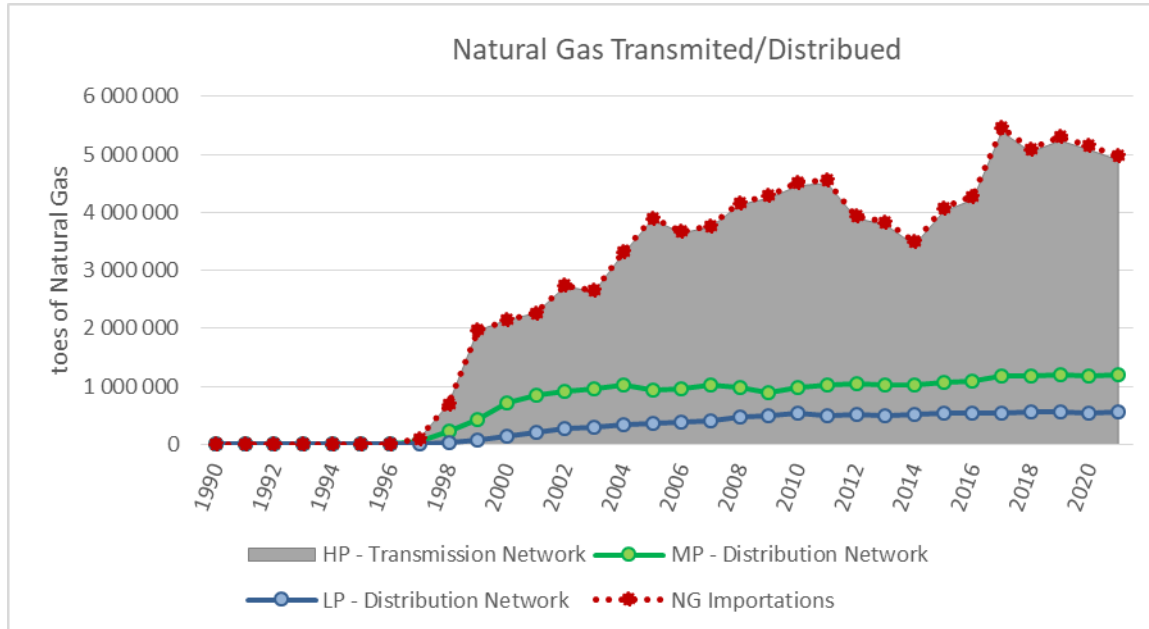

Figure 3-64: Natural Gas transported by High, Medium and Low Pressure Networks

3.8.4.5 Uncertainty Analysis

The uncertainty in activity data was considered to be 5 %, the value that was used for other statistical information gathered from the Energy Balance as area sources. The uncertainty in CH₄ emission factor, considering a low quality inventory, was assumed to be 150 %, and the same value was considered for CO₂ emissions which were determined simply from simple conversion of emissions in methane form.

3.8.4.6 Category-specific QA/QC and verification

General revision of time series consistency for fuel consumption and emission factors was the only QA/QC procedure adopted for this sector.

To further improve the QA/QC analysis a comparison between fuel consumption values reported by DGEG and IEA (International Energy Agency) was made (please see the chapter Comparison of Energy Balance vs. IEA Energy Statistics). No significant differences were found between data sources for this category.

3.8.4.7 Recalculations

No recalculations in this submission.

3.8.4.8 Further Improvements

We intend, if possible, to obtain information on leaks in the transportation and distribution of Natural Gas related to the period prior to 2009.



3.8.5 Oil and natural gas and other emissions from energy production: Venting and Flaring (CRF 1.B.2.c)

3.8.5.1 Category description

Venting activities do not occur in Portugal.

Regarding flaring activities in Portugal, flaring of natural gas and waste gas/vapor streams at gas facilities do not occur in Portugal, they occur only in oil industry. Flares were used at the three refineries in Portugal to control and burn non-condensable gases recovered from leakages and blow down operations, which would otherwise be emitted as volatile organic compounds. Although smokeless and complete combustion is always an objective, sometimes the gas influx exceeds flare combustion capacity and partly unburned organic compounds are emitted: NMVOC, CH₄ and CO.

3.8.5.2 Methodology

All carbon emitted in compounds, such as CO, NMVOC and CH₄, has fossil origin and must be included in the estimate of ultimate CO₂ emissions. Individual pollutants (end of pipe CO₂, NMVOC, CH₄ and CO) are converted into ultimate CO₂ according to:

$$U_{CO_2} = \text{EndofPipe}_{CO_2} + 44/12 \times (0.60 \times \text{NMVOC} + 12/16 \times \text{CH}_4 + 12/28 \times \text{CO}) \times 10^{-3}$$

Air emissions in flaring, resulting from combustion of gas collected from leaks and blowdown system, were estimated either from the quantity of gas flared or total feed to refinery.

CO₂ emissions were estimated according to the following equation:

$$\text{Emi}_{CO_2(y)} = \text{Flare}_{Gas(y)} \times \text{LHV}_{Gas(y)} \times \text{EF}_{CO_2} \times \text{OF}_{Gas(y)} \times 10^{-3}$$

Where:

Emi_{CO₂(y)}: Emission of CO₂ in year y (t/yr)

Flare_{Gas(y)}: Quantity of gas flared in year y (t/yr)

LHV_{Gas(y)}: Low Heating Value of gas flared in year y (GJ/t)

EF_{CO₂}: Emission factor of CO₂ (kg/GJ)

OF_{Gas(y)}: Oxidation factor of gas flared in year y (dimensionless)

CH₄ emissions were estimated according to the following equation:

$$\text{Emi}_{(p,y)} = \text{EF}_{(p)} \times \text{Flare}_{GAS(y)} \times m_{(p,y)} / m_{(gas,y)} \times 10^{-3}$$

Where:

Emi_{CH₄(y)}: Emission of CH₄ in year y (t/yr)

Flare_{GAS(y)}: Quantity of gas flared in year y (t/yr)

EF_{CH₄}: Emission factor of CH₄ (Kg/t gas)

m_(CH₄,y)/m_(gas,y): Mass fraction of CH₄ in year y

N₂O emissions were estimated according to the following equation:

$$\text{Emi}_{N_2O(y)} = \text{EF}_{N_2O} \times \text{Crude}$$

Where:

Emi_{N₂O(y)}: Emission of N₂O in year y (t/yr)



EF_{N₂O}: Emission factor of N₂O (Gg/10³ m³)

Crude: Total amount of crude throughput (t)

For NMVOC and CO emissions, please check Portugal IIR.

3.8.5.3 Emission Factors

Emission factors for CO₂ were derived from EU-ETS data for Sines and Porto refineries and from US-EPA (1991) for Lisbon refinery.

Emission factors for CH₄ were set from “Concawe – Air pollutant emission estimation methods for E-PRTR reporting by refineries – report no. 4/17 (2017 Edition)”.

N₂O emission factor was taken from Table 4.2.4 of Chapter 4 of Volume 2 of the 2006 IPCC Guidelines.

Feed density was assumed equal to 0.85 t/m³ for API crude oil 30-40°C.

Table 3-98: Emission Factors for flaring in refineries

Pollutant	EF Unit	EF
CO ₂ (kg/GJ)	Kg/GJ	46.6 - 62.6
CH ₄	kg/t gas	5
N ₂ O	Gg/10 ³ m ³	6.4E-07

3.8.5.4 Activity data

Porto has terminated its refining activities in April 2021. Only Sines unit remains in operation.

For estimating CO₂ and CH₄ emissions, total flare gas consumed in the three units and Low Heating Value was made available from PETROGAL for the period 1990-2004. From 2005 onwards data is obtained from EU-ETS.

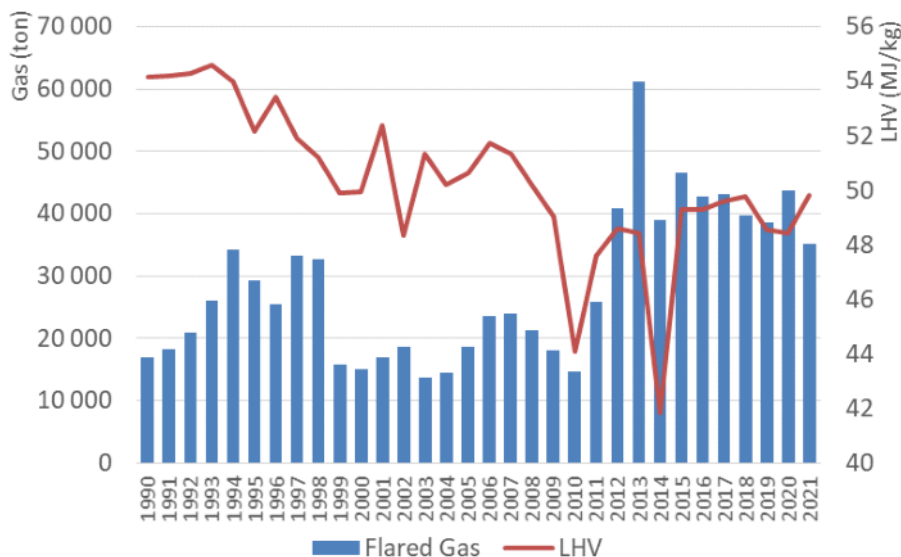

Figure 3-65: Total consumption of flare gas in Portuguese refineries and Low Heating Value

Activity data used for estimating N₂O emissions was the total amount of crude throughput, which was obtained from DGEG for the whole time series.

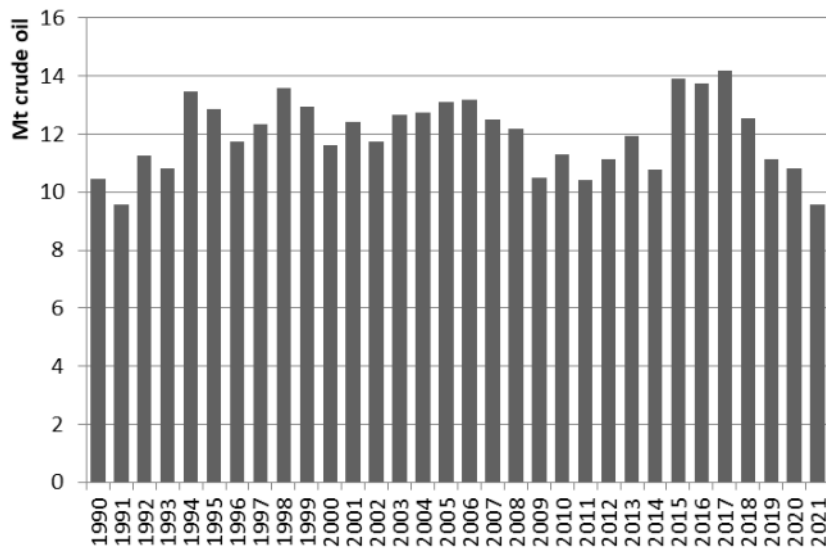

Figure 3-66: Total amount of crude throughput in refineries

3.8.5.5 Uncertainty Assessment

The uncertainty in activity data was considered to be 3 %, the value used when activity data refer data directly collected from the units. The uncertainty in NMVOC/CO₂ emission factor is 50 % and the double of that value for CH₄ and N₂O emissions.

3.8.5.6 Recalculations

No recalculations were made.

3.8.5.7 Further Improvement

No further improvements are planned for this sector.



3.8.6 Other Fugitive Emissions (Geothermal Electricity Production) (CRF 1.B.2.d)

3.8.6.1 Category description

A small amount of electricity is produced from two geothermic sources in Azores archipelago: *Pico Vermelho* (commissioned in 1980) and *Ribeira Grande* (commissioned in 1994) Plants, and they are assumed to increment the release of carbon dioxide to atmosphere.

The available reporting (CRF) categories do not consider a specific place to report CO₂ emissions from geothermal electricity production. Nevertheless, emissions from these activity are clearly related to sector 1 (Energy) and must be better considered as fugitive emissions. However, for fugitive emissions the CRF nomenclature allows only the classes Solid Fuels (1B1) and Oil and Natural Gas (1B2), which are not exactly suitable for this activity. Sector 7 (Other) could be used in principle, but would imply that emissions from this category would be no longer included in the energy sector.

Fugitive emissions from geothermal electricity production are therefore reported in category 1B2d (Other fugitive emissions from oil and natural gas).

The category has been identified as key in the KC analysis in previous submissions and was included the 2014 Methodological Development Plan (PDM), which lead to the revision of estimates based on new data collected by the Autonomous Region of Azores.

3.8.6.2 Methodology

From 1994 till 1999, the Regional Authority of Economy (Secretaria Regional da Economia. Direcção Regional do Comércio, Indústria e Energia) performed estimates of carbon dioxide released to atmosphere from geothermic units and these were considered in the National Inventory.

These data have been considered as inadequate and not consistent with reality by the authorities of the Autonomous Region of Azores, who made available new data referring to the characterization of a real situation of the Geothermal Electricity Production in Azores for 2008-2011 period.

The fraction from steam geothermal fluid captured in geothermal wells was chemical analysed. Those results allowed the estimation of CO₂ mass released to the atmosphere and the calculation of a CO₂ emission factor for unit of electricity produced.

Since the 2010 inventory all data concerning geothermal production is obtained from the Azores environmental entity (this time series starts in 2003). For the years prior to 2003 emissions of CO₂ were estimated from electricity production reported by DGEG.

3.8.6.3 Emission factors

Measurements of carbon dioxide emissions available from Ribeira Grande and Pico Vermelho from 2008 till 2011, presented in next table, were provided by the regional authority of the Autonomous Region of Azores²⁴. These results were used to estimate an average emission factor applied to the whole period on both plants (Ribeira Grande and Pico Vermelho).

The calculation of the amount of CO₂ released by a geothermal power station is based on point-by-point chemical analyzes carried out on the gas fraction of the geothermal fluid, the results of which are extrapolated for the year.

²⁴ Secretaria Regional dos Recursos Naturais – Direcção Regional do Ambiente.



Thus, the calculation of the CO₂ emission is significantly influenced by the exploration effort of the plants, being directly affected by the unavailability of the geothermal wells of the production and of the auxiliary generating groups in the presence of maintenance needs.

In order to minimize the influence of these factors in the determination of the emission factor, a period of 3 years was defined for this calculation, considering that it is a reasonable time horizon to represent the evolution of the extraction effort and consequently of the CO₂ emissions in the course of the operation of the Ribeira Grande and Pico Vermelho geothermal plants.

Table 3-99: Emission Factors for Geothermal Electricity Production

Parameter	2008	2009	2010	2011
Production (GWh)	171	162	174	186
CO ₂ (t)	19 573	28 206	36 054	40 094
Emission Factor observed (t/GWh)	115	174	207	215
Emission Factor to Geothermal Electricity Production (tCO₂/GWh) (Average of last three years)				198.7

Source: Grupo EDA – Energia dos Açores

The variation of the emission factor observed is due to the different flow of CO₂ emitted by each geothermal well and flexible operating regime of the geothermal plants. The CO₂ emission factor adopted for geothermal power plants is the average of the last three years, 199 tCO₂/GWh.

3.8.6.4 Activity Data

Activity data consists of geothermal production. The time series was constructed using data from the regional authority in Azores:

- Pico Vermelho (old power plant) – from 1990 to 2005;
- Pico Vermelho (new power plant) – from 2006 to 2020;
- Ribeira Grande – from 1994 to 2020.
- Pico Alto – from 2017 to 2020

Data from DGEG was used to fill in information gaps mainly for Pico Vermelho 1990 to 1999 geothermal production. The following figure shows the total geothermal production time series in Azores.

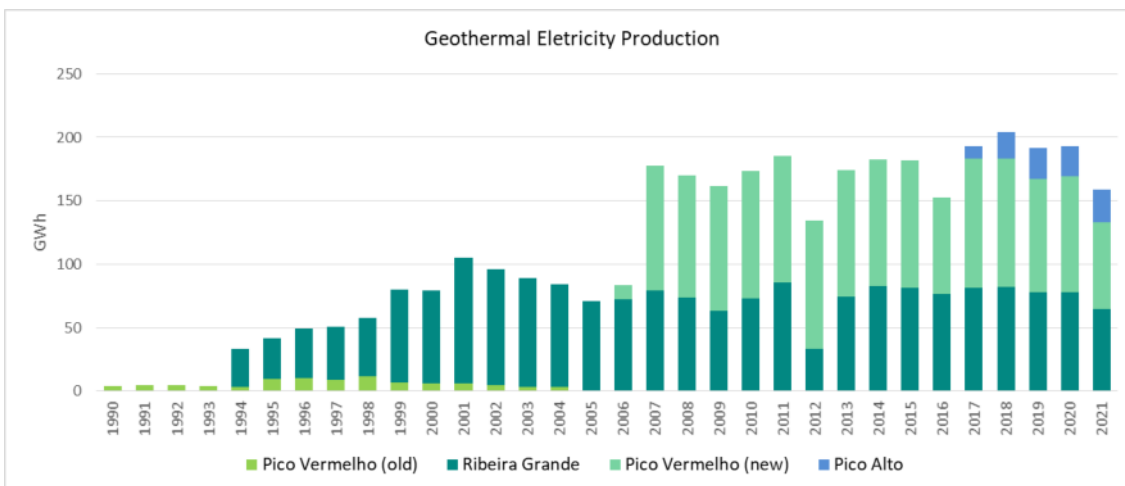

Figure 3-67: Total Geothermal Production in Azores



In 2006 a new power plant was commissioned in *Pico Vermelho* following the decommissioning of the old installation. This new plant tripled the installed power of *Pico Vermelho* (from 3 MW to 10 MW). For *Ribeira Grande* improvements were made in 1998 to the existing installation that almost tripled the installed power (from 5MW to 13 MW).

3.8.6.5 Uncertainty Analysis

The uncertainty of the activity data is 5 % considering that the statistical information is reliable but some extrapolations have been performed for earlier years, namely to separate data per power plant.

The uncertainty in the emission factor has been estimated as 21.9 % on the basis of the variation of the EF (measured data).

3.8.6.6 Recalculations

No recalculations were made.

3.8.6.7 Further Improvements

No further improvements are planned for this sector.



3.8.7 Other Fugitive Emissions (City Gas Production) (CRF 1.B.2.d)

3.8.7.1 Category description

According to the energy balances from DGEG, this activity has used fuel oil, naphtha and, more recently, natural gas as energy sources under co-generation process, from 1990 till 2001. Explanations concerning the combustion emissions associated with the production of City Gas are explained in chapter 1.3.1.2 Manufacture of solid fuels and other energy industries (CRF 1.A.1.c.).

The 2006 IPCC guidebook does not provide CH₄ and CO₂ emission factors for the estimation of emissions for the city gas production sector. Therefore, we decided to report the Notation Key "NE" category for the 1990-2001 period and thereafter "NO".



3.9 Sector-specific QA/QC and verification

A Streamline of Emission Factors and Low Heating Values used in the estimation of CO₂ emissions was implemented to the Energy Sector, the goal of this activity was to bring closer the estimation process in this sector.

CO₂ Emission Factor (EF) and the Low Heating Value (LHV) for specific fuels were compared for the different categories in the Energy Sector:

- Electricity and Heat Production (1.A.1.a)
- Manufacturing Industries (Combustion) (1.A.2)
- Transports (1.A.3)

Low Heating Value:

The main sources of LHV data used in the inventory come from

- Energy Balance (DGEG)
- Operators measuring's for specific unit (CELE)
- Operators reporting's (Autocontrolo)

No major differences in values were detected between sub-sectors. Although, a deeper analysis to the solid fuel was needed to clarify different fuel nomenclature and the respective LHV's.

Whenever available, the operators measured data was kept for energy consumption estimations in specific units. The LHV data from DGEG was used as a default for the inventory.

CO₂ Emission Factor:

In the inventory the CO₂ EF from 2006 IPCC Guidelines was used as default; when available, measured data from operators (CELE and Autocontrolo) was used instead.

No major differences were detected.



3.10 Further Improvements

Considering that the energy sector is the most prevalent emission source, special efforts must always be made to improve emission estimates, even if they affect smaller energy sub-sectors. Future improvements to the inventory will depend on the conclusions of the PDM in the scope of SNIERPA's implementation, which is being made with direct contact with the main stakeholders of the energy sector, and in close collaboration of the inventory team from APA. Although the main conclusions from this report are still not set in a final report and plan, the following preliminary routes may be here identified.

- Better integration between activity data in the air emissions inventory and other surveys such as LCP directive, Autocontrolo program, EPER/E-PRTR, the EU-ETS and the energy surveys (co-generation) made annually by DGEG. Contacts are being made to implement it. Particular work is being done to streamline the collection of data and emission estimates between the inventory and the EU-ETS, following the promotion efforts that are being made by the European Commission;
- Determination of country-specific emission factors (SO_x and NO_x) from monitoring data collected from the Autocontrolo program and CO₂ emission factors for information collected under carbon market;
- Consistency Checks on Refining/Storage timeseries.



3.11 Reference Approach

3.11.1 Category description

The reference approach consists in the estimate of CO₂ emissions using the simple approach tier 1 of IPCC. Although the Portuguese National Inventory uses a sectoral approach (National Approach) of higher tier level, nevertheless the UNFCCC reporting guidelines request that parties make also a top-down “reference approach”²⁵ for estimation of CO₂ emissions from fossil fuel combustion, in addition to the bottom-up sectoral methodology.

The Reference Approach is a top-down approach, using a country’s energy supply data to calculate the emissions of CO₂ from combustion of mainly fossil fuels. The Reference Approach is a straightforward method that can be applied on the basis of relatively easily available energy supply statistics. Excluded carbon has increased the requirements for data to some extent. However, improved comparability between the sectoral and reference approaches continues to allow a country to produce a second independent estimate of CO₂ emissions from fuel combustion with limited additional effort and data requirements. It is good practice to apply both a sectoral approach and the reference approach to estimate a country’s CO₂ emissions from fuel combustion and to compare the results of these two independent estimates (IPCC. 2006).

The Reference Approach requires simple statistics for production of fuels and their external trade as well as changes in their stocks. It also needs a limited number of values for the consumption of fossil products used for non-energy purposes, where carbon may be stored.

3.11.2 Methodology

The following methodological steps were made in accordance with IPCC (2006):

- Step 1: Estimate Apparent Fuel Consumption in Original Units;
- Step 2: Convert to a Common Energy Unit;
- Step 3: Multiply by Carbon Content to Compute the Total Carbon;
- Step 4: Compute the Excluded Carbon;
- Step 5: Correct for Carbon Unoxidised and Convert to CO₂ Emissions.

3.11.2.1 Fuel consumption

Apparent consumption was estimated from energy balances from DGEG according to:

Apparent Consumption = Production + Imports - Exports- Stock Change.

for primary fuels and,

Apparent Consumption = Imports - Exports- Bunkers - Stock Change.

for secondary fuels.

National production is not considered because the carbon in these fuels was already included in the supply of primary fuels from which they were derived.

²⁵ This does not mean that a “bottom-up” approach should not be followed for estimating CO₂ emissions but the total emissions must be compared with those obtained from the Reference Approach.



3.11.2.2 Energy Consumption

The Portuguese National Balance reports consumption in energy units (toe²⁶), apparent consumption needs only to be converted to TJ using the multiplier 41.868 GJ/toe.

3.11.2.3 Carbon Content of Fuels

Carbon content in apparent consumption is estimated in reference approach from:

$$\text{Apparent Consumption}_{(\text{Gg C})} = \text{Apparent Consumption}_{(\text{TJ})} * \text{Carbon Content}_{(\text{MgC} / \text{TJ})} * 10^{-3}$$

The carbon content of fuels was determined using the Carbon Emission Factors used in the sectoral approach, which are presented in Table 3.144.

Table 3-100: Carbon content of fuels and Oxidation Factor used in the Reference Approach

Fuel		C content (t C/TJ)	Fac _{COx} 0 - 1	
Liquid Fossil	Primary Fuels	Crude Oil	20.0	1.00
		Orimulsion	21.0	1.00
		Natural Gas Liquids	-	-
	Secondary Fuels	Gasoline	18.9	1.00
		Jet Kerosene	19.5	1.00
		Other Kerosene	19.6	1.00
		Shale Oil	-	-
		Gas / Diesel Oil	20.2	1.00
		Residual Fuel Oil	21.1	1.00
		LPG	17.2	1.00
		Ethane	-	-
		Naphtha	20.0	1.00
		Bitumen	22.0	1.00
		Lubricants	20.0	1.00
		Petroleum Coke	26.6	1.00
		Refinery Feedstocks	20.0	1.00
		Other Oil	20.0	1.00
Solid Fossil	Primary Fuels	Anthracite (a)	26.8	1.00
		Coking Coal	25.8	1.00
		Other Bit. Coal	25.8	1.00
		Sub-bit. Coal	26.2	1.00
		Lignite	27.6	1.00
		Oil Shale and tar sand	29.1	1.00
	Secondary Fuels	BKB & Patent Fuel	22.0	1.00
		Coke Oven/Gas Coke	29.2	1.00
		Coal tar	-	-
Gaseous Fossil	Natural Gas (Dry)	15.3	1.00	
Waste (non-biomass fraction)		21.8	1.00	
Peat		-	-	
Biomass	Solid Biomass	29.9	1.00	
	Liquid Biomass	20.0	1.00	
	Gas Biomass	30.6	1.00	

²⁶ Ton of oil equivalent



3.11.2.4 Carbon Excluded

The aim of the Reference Approach is to provide an estimate of fuel combustion emission, so the amount of carbon which does not lead to fuel combustion emissions is excluded. Carbon excluded from fuel combustion is either emitted in another sector of the inventory (industrial process emission) or is stored in a product manufactured from the fuel.

The main flows of carbon concerned in the calculation of excluded carbon are those used as feedstock, reductant or as non-energy products.

Feedstock - Carbon emissions from the use of fuels listed above as feedstock are reported within the source categories of the Industrial Processes and Product Use (IPPU) chapter. Consequently, all carbon in fuel delivered as feedstock is excluded from the total carbon of apparent energy consumption.

Non-energy products use – The Inventory excludes consumptions of bitumen, lubricants, paraffin, solvents and propylene, these are classified as non-energy oil in the National Energy Balance.

The quantity of carbon to be excluded from the estimation of fuel combustion emissions is calculated according to following equation:

$$\text{Excluded Carbon}_{\text{fuel}} (\text{Gg C}) = \text{Activity Data}_{\text{fuel}} (\text{TJ}) \times \text{Carbon Content}_{\text{fuel}} (\text{C/TJ}) \times 10^{-3}$$

In the figure below it is possible to observe the total energy excluded from apparent consumption during the time series.

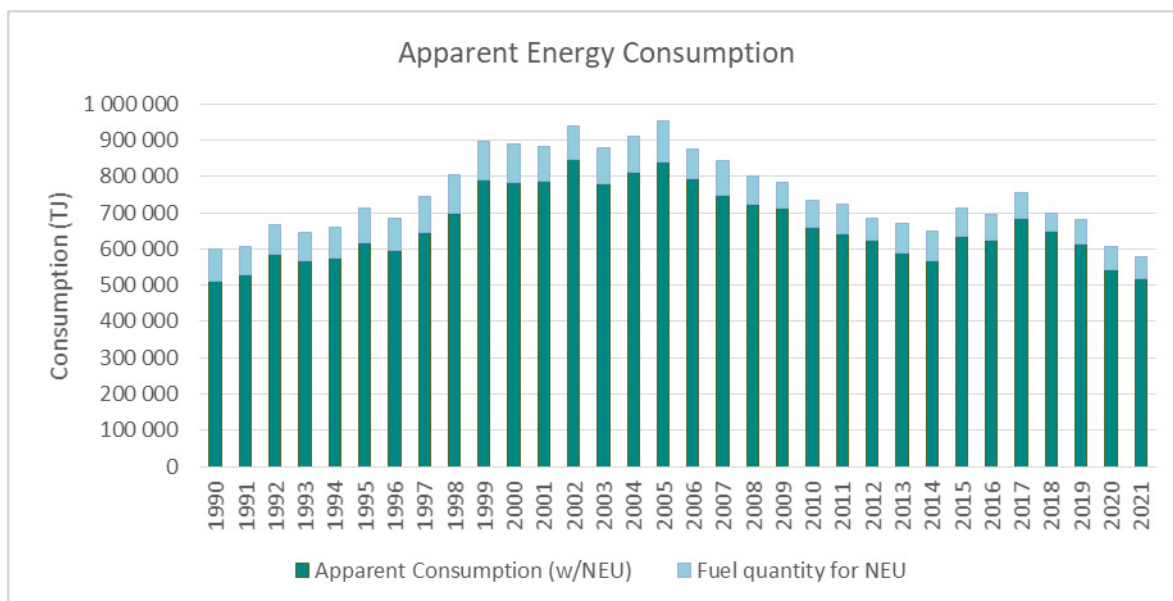

Figure 3-68: Apparent energy consumption

This excluded energy concerns mainly the consumption as a feedstock of Naphtha and more recently LPG and Natural Gas in the Industrial Processes sector and non-energetic use of Bitumen, Lubricants and Other oil. Some losses associated with oil refining were also excluded from the reference approach, since these were not classified as energy consumptions.

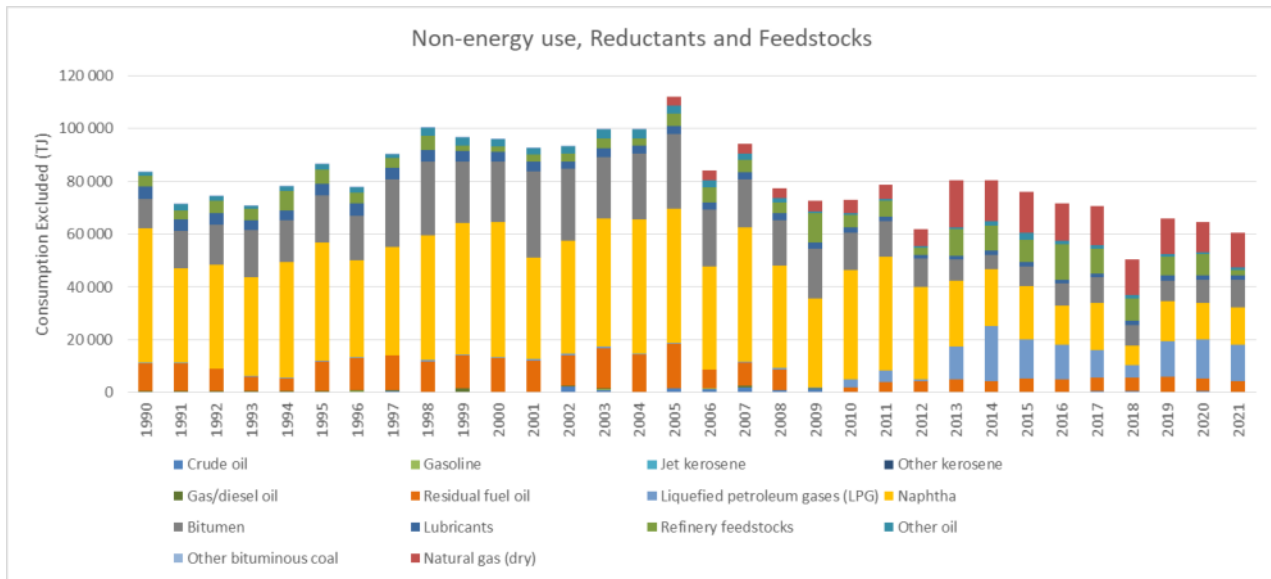

Figure 3-69: Fuel consumption excluded from Apparent Consumption

3.11.3 Actual Carbon Dioxide Emissions

Estimated simply from:

$$\text{CO}_2 \text{ Emission} = 44/12 * (\text{Apparent Consumption} - \text{Excluded Carbon}) * \text{Oxidation Factor}$$

3.11.4 Results - Comparison of Reference Approach and Sectoral Approach

Detailed data used in the reference approach calculation is reported in CRF tables and is not duplicated in NIR. The emissions estimated according to reference approach and national approach are presented in the figure below and show differences in both energy consumption and carbon emissions.



Figure 3-70: Comparison of Energy Consumption and CO₂ emissions between the National approach and the Reference Approach

Differences are mostly explained by the following:

- differences in the Energy Balance and the energy activity data used by the inventory – where data collected directly from emission units (Large Point Sources) play a very representative role – and a different approach to account for emissions from carbon stored in products;
- specific LHV values for LPS are not always considered in the Energy Balance;
- the % of feed-stocks which carbon is stored in products are default values and not specific of the national conditions reflected in the inventory;
- the energy balance as been updated in order to follow the IPCC criteria to distinguish between domestic and international fuel use. This improvement contributes to decrease the difference between the reference and the sectoral approach. Portugal is still developing efforts to further improve the split between domestic and international consumption in the energy balance.

The difference between the approaches in terms of CO₂, has been reduced after 2001, which is coincident with the efforts that were made by DGEG and APA in order to improve consistency between the different approaches. The slight increase in the difference between the two approaches from 2008 to 2009 may be due to the reclassification of lime production and the corrections of double counting for some co-generation power plants. Differences in CO₂ emissions are mainly associated with emissions of industrial waste and municipal solid waste. As they are about carbon contents with great variability, it is our intention to estimate a national value to use in the reference approach.



3.11.5 Feedstock

Emissions of greenhouse gas emissions from feedstock use are only clearly accounted in the inventory in the following situations:

- emission of CO₂ resulting from use of feedstock sub-products as energy sources. That is the case of emissions from consumption of fuel gas in refinery and petrochemical industry;
- emission of CO₂ liberated as sub-product in production processes such as ammonia production;
- emission of NMVOC from fossil fuel origin, and occurring from solvent use and evaporation. Although in this case it is not possible to establish which part results from feedstock consumption in Portugal in the energy balance.

However, some potential emissions are not estimated or are only partly estimated. Those that are estimated in the reference approach but not in sectoral approach are:

- emissions from mineral oil use as lubricants;
- emissions from wear of bitumen in roads.

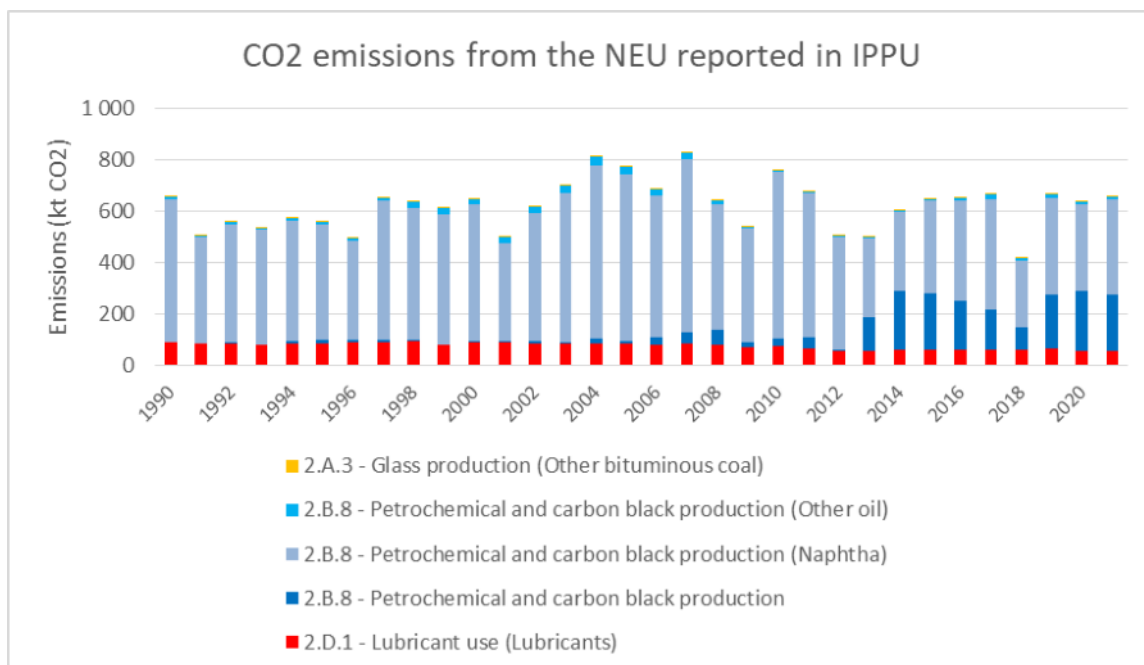

Figure 3-71: Carbon dioxide (CO₂) emissions from non-energy use by sector

CRF Table 1.A. (d) reports consumption of fuels whose carbon content is excluded from the reference approach. Non-energy uses are also associated with emissions that occur in the IPPU sector from the use of such fuels as feedstocks, reductants and other non-energy uses. However, as explained, in the methodology some of the excluded carbon refers to losses in the refinery sector that are reported in the energy balance. These losses do not relate to non-energy uses and may be allocated to the fugitive emissions sector 1B. Hence reporting NO for some of the fuels that have NEU amounts but have no associated emissions in the IPPU sector.

The values of Natural Gas excluded from the Reference Approach analysis in Table 1.A (D) refer to non-energy consumption of natural gas that occurs in Oil Refineries and that are considered in fugitive emissions sector. The inability to choose this category from the drop-down list in table 1.A (d) does not allow reporting this information transparently.

In this way the values reported in cell I39 of Table 1.A(d) are considered in the Sectoral Approach in Table 1.B.2 cell H13, which includes other emission sources in addition to hydrogen production.

4 Industrial Processes and Products Use (CRF Sector 2)

Table of Contents

4	Industrial Processes and Products Use (CRF Sector 2)	4-1
4.1	Overview of the sector	4-12
4.2	Mineral Industry (CRF 2.A)	4-16
4.2.1	Overview	4-16
4.2.2	Cement Production (CRF 2.A.1)	4-16
4.2.3	Lime Production in dedicated plants (CRF 2.A.2)	4-21
4.2.4	Lime Production in Iron and Steel (CRF 2.A.2)	4-27
4.2.5	Lime Production in Paper Pulp (CRF 2.A.2)	4-30
4.2.6	Lime production in Other Sectors (CRF 2.A.2)	4-32
4.2.7	Glass Production (CRF 2.A.3)	4-35
4.2.8	Glass Wool Production (CRF 2.A.3)	4-40
4.2.9	Other Process Uses of Carbonates - Ceramics (CRF 2.A.4.a)	4-41
4.2.10	Other Process Uses of Carbonates-Other Uses of Soda Ash (CRF 2.A.4.b)	4-46
4.2.11	Other Process Uses of Carbonates-Non Metallurgical Magnesia Production (CRF 2.A.4.c)	4-50
4.2.12	Other Process Uses of Carbonates – Other (CRF 2.A.4.d)	4-50
4.2.13	Other - Rock wool Production (CRF 2.A.5)	4-53
4.3	Chemical Industry (CRF 2.B)	4-57
4.3.1	Overview	4-57
4.3.2	Ammonia Production (CRF 2.B.1)	4-57
4.3.3	Nitric Acid Production (CRF 2.B.2)	4-61
4.3.4	Adipic Acid Production (CRF 2.B.3)	4-64
4.3.5	Caprolactam, Glyoxal and Glyoxylic Acid Production (CRF 2.B.4)	4-64
4.3.6	Silicon Carbide and Calcium Carbide Production (CRF 2.B.5)	4-64
4.3.7	Titanium Dioxide Production (CRF 2.B.6)	4-64
4.3.8	Soda Ash Production (CRF 2.B.7)	4-66



4.3.9	Petrochemical and Carbon Black Production – Methanol (CRF 2.B.8.a)	4-66
4.3.10	Petrochemical and Carbon Black Production – Ethylene (CRF 2.B.8.b)	4-66
4.3.11	Petrochemical and Carbon Black Production– Ethylene Dichloride and Vinyl Chloride Monomer (VCM) (CRF 2.B.8.c)	4-68
4.3.12	Petrochemical and Carbon Black Production – Ethylene Oxide (CRF 2.B.8.d)	4-68
4.3.13	Petrochemical and Carbon Black Production – Acrylonitrile (CRF 2.B.8.e)	4-68
4.3.14	Petrochemical and Carbon Black Production – Carbon Black (CRF 2.B.8.f)	4-69
4.3.15	Petrochemical and Carbon Black Production – Other (CRF 2.B.8.g)	4-70
4.3.16	Fluorochemical Production (CRF 2.B.9)	4-71
4.3.17	Other - Sulphuric Acid Production (CRF 2.B.10.a)	4-71
4.3.18	Other – Explosives Production (CRF 2.B.10.c)	4-72
4.3.19	Other – Solvent Use in Plastic Manufacturing (CRF 2.B.10.d)	4-72
4.4	Metal Industry (CRF 2.C)	4-73
4.4.1	Overview	4-73
4.4.2	Iron and Steel Production (CRF 2.C.1)	4-73
4.4.3	Ferroalloys Production (CRF 2.C.2)	4-82
4.4.4	Aluminium Production (CRF 2.C.3)	4-83
4.4.5	Magnesium Production (CRF 2.C.4)	4-83
4.4.6	Lead Production (CRF 2.C.5)	4-83
4.4.7	Zinc Production (CRF 2.C.6)	4-84
4.4.8	Copper Production (CRF 2.C.7.a)	4-84
4.5	Non-energy Products from Fuels and Solvents Use (CRF 2.D)	4-85
4.5.1	Overview	4-85
4.5.2	Lubricants Use (CRF 2.D.1)	4-85
4.5.3	Paraffin Wax Use (CRF 2.D.2)	4-87
4.5.4	Solvent Use – Solvent Use (CRF 2.D.3.a)	4-89
4.5.5	Solvent Use – Road Paving with Asphalt and Asphalt Blowing in Refineries (CRF 2.D.3.b) .	4-89
4.5.6	Solvent Use – Urea based catalytic converters (CRF 2.D.3.c)	4-90
4.6	Electronics Industry (CRF 2.E)	4-91
4.6.1	Overview	4-91
4.6.2	Integrated Circuit or Semiconductor (CRF 2.E.1)	4-91
4.6.3	TFT Flat Panel Display (CFR 2.E.2)	4-91
4.6.4	Photovoltaics (CRF 2.E.3)	4-92
4.6.5	Heat Transfer Fluid (CRF 2.E.4)	4-92



4.7	Products Uses as substitutes for ODS (CRF 2.F)	4-93
4.7.1	Overview	4-93
4.7.2	Commercial Refrigeration (CRF 2.F.1.a)	4-96
4.7.3	Domestic Refrigeration (CRF 2.F.1.b)	4-103
4.7.4	Industrial Refrigeration (CRF 2.F.1.c)	4-111
4.7.5	Transport Refrigeration (CRF 2.F.1.d)	4-114
4.7.6	Mobile Air Conditioning (CRF 2.F.1.e)	4-118
4.7.7	Stationary Air Conditioning (CRF 2.F.1.f)	4-127
4.7.8	Foam Blowing (CRF 2.F.2)	4-132
4.7.9	Fire Protection (CRF 2.F.3)	4-134
4.7.10	Aerosols – Metered Dose Inhalers (CRF 2.F.4.a)	4-139
4.7.11	Aerosols – Other Aerosols (CRF 2.F.4.b)	4-140
4.8	Other Product Manufacture and Use (CRF 2.G)	4-142
4.8.1	Overview	4-142
4.8.2	Manufacture of Electrical Equipment (CRF 2.G.1.a)	4-142
4.8.3	Use of Electrical Equipment (CRF 2.G.1.b)	4-143
4.8.4	SF6 and PFCs from Other Product Use (CRF 2.G.2)	4-148
4.8.5	N ₂ O from Product Use – Medical Application (CRF 2.G.3.a)	4-148
4.8.6	N ₂ O from Product Use – Propellant for pressure and aerosol products (CRF 2.G.3.b)	4-149
4.9	Other (CRF 2.H)	4-150
4.9.1	Overview	4-150
4.9.2	Pulp and Paper Industry (CRF 2.H.1)	4-150
4.9.3	Food Manufacturing (CRF 2.H.2)	4-152
4.9.4	Drink Manufacturing (CRF 2.H.2)	4-152
4.9.5	Wood Chipboard Production (CRF 2.H.3.a)	4-152
4.9.6	Carbon electrodes consumption (CRF 2.H.3.b)	4-152

List of Figures

Figure 4-1: IPPU emissions from total GHG emissions in 2021, by source sub-sector	4-12
Figure 4-2: Total GHG emissions from IPPU per source sub-sector (kt CO ₂ e)	4-14
Figure 4-3: Emissions of Industrial processes by sub-source sector in Portugal in year 1990 and 2021 (kt CO ₂ e)	4-14
Figure 4-4: GHG Emissions from IPPU per gas in 2021	4-14



Figure 4-5: Raw meal consumption in Portugal	4-19
Figure 4-6: Total clinker production in Portugal.....	4-19
Figure 4-7: Clinker production data – comparison of approaches.....	4-20
Figure 4-8: Lime production from different sources	4-24
Figure 4-9: Lime production reported in the CRF tables	4-25
Figure 4-10: Lime production in dedicated plants – comparison of approaches.....	4-27
Figure 4-11: Lime production and steel production from BOF in Iron and Steel	4-29
Figure 4-12: Lime production in Iron and Steel.....	4-29
Figure 4-13: Lime Production in paper pulp.....	4-31
Figure 4-14: CaCO ₃ Consumption in paper pulp	4-32
Figure 4-15: Glass production	4-36
Figure 4-16: Raw materials consumption.....	4-38
Figure 4-17: Cullet incorporation by type of glass.....	4-38
Figure 4-18: Raw materials consumption in EU-ETS plants in 2021.....	4-44
Figure 4-19: Energy consumption in ceramics sector by fuel type (Source: Energy Balance)	4-44
Figure 4-20: % Energy consumption in ceramics sector in 2021.....	4-45
Figure 4-21: Raw materials consumption in ceramics sector.....	4-45
Figure 4-22: Soda ash apparent consumption	4-48
Figure 4-23: Recalculations in Other uses of soda ash.....	4-49
Figure 4-24: Consumption of carbonate materials in fertilizer industry.....	4-52
Figure 4-25: Limestone consumption and rock wool production	4-55
Figure 4-26: Ammonia Production by Partial Oxidation.....	4-58
Figure 4-27: Trend in Ammonia and Urea production	4-60
Figure 4-28: Ammonia production data – comparison of approaches	4-61
Figure 4-29: Trend in Nitric Acid production.....	4-63
Figure 4-30: Trend in Titanium Dioxide Production	4-65
Figure 4-31: Trend in Ethylene production	4-67
Figure 4-32: Ethylene production data – comparison of approaches.....	4-68
Figure 4-33: Carbon Black production.....	4-70
Figure 4-34: Integrated iron and steel facility – production of steel and intermediate products (1990-2001)	4-80
Figure 4-35: Steel production by process.....	4-81
Figure 4-36: Crude steel production in Portugal – comparison of approaches	4-82
Figure 4-37: Secondary Lead production data (Index 1990=100%)	4-84



Figure 4-38: Amount of Lubricants used in Portugal.....	4-86
Figure 4-39: Amount of Paraffin Wax used in Portugal.....	4-88
Figure 4-40: Trends in emissions from product uses as substitutes for ODS.....	4-93
Figure 4-41: Share of emissions by subcategory	4-93
Figure 4-42: Number of commercial refrigeration assembled units in Portugal	4-99
Figure 4-43: Number of commercial establishments by type	4-100
Figure 4-44: Number of commercial refrigeration equipment	4-101
Figure 4-45: Domestic refrigeration equipment assembled in Portugal by type of fluid.....	4-104
Figure 4-46: Domestic refrigeration equipment in operation in Portugal by type of fluid and share of households with refrigeration equipment	4-105
Figure 4-47: Domestic refrigeration equipment disposed in Portugal by type of fluid	4-107
Figure 4-48: Recalculations in Domestic Refrigeration – assembly and operation phase	4-109
Figure 4-49: Recalculations in Domestic Refrigeration – disposal phase and fluid recovery.....	4-109
Figure 4-50: Recalculations in Domestic Refrigeration – 2.F.1.b and overall 2.F.1.....	4-110
Figure 4-51: Number of equipment assembled in Portugal.....	4-116
Figure 4-52: Number of registered vehicles in circulation in Portugal using HFC.....	4-116
Figure 4-53: Disposal of equipment using HFC.....	4-117
Figure 4-54: Vehicles assembled in Portugal by type of MAC fluid.....	4-122
Figure 4-55: Fleet of vehicles circulating in Portugal by type of MAC fluid	4-123
Figure 4-56: Vehicles at end-of-life by type of MAC fluid	4-125
Figure 4-57: Number of Stationary Air Conditioning equipment assembled in Portugal	4-128
Figure 4-58: Annual Stock of Stationary Air Conditioning equipment in Portugal.....	4-129
Figure 4-59: Disposal of Stationary Air Conditioning equipment in Portugal	4-129
Figure 4-60: HFC consumption in new Fire protection equipment by type of gas	4-136
Figure 4-61: Stocks of HFC in Fire protection equipment by type of gas	4-137
Figure 4-62: Flowchart of the National Electric System	4-143
Figure 4-63: Map of National Network of Electric Energy Transport.....	4-144
Figure 4-64: Total SF6 in stock in electric equipment in Portugal.....	4-147
Figure 4-65: N ₂ O consumption data	4-148
Figure 4-66: Total production of paper pulp	4-151
Figure 4-67: Consumption of carbon electrodes in industry.....	4-153



List of Tables

Table 4-1: Total GHG emissions from IPPU	4-13
Table 4-2: Key categories in IPPU (CRF 2) and methodologies used in emission estimates	4-15
Table 4-3: Uncertainty values related to emissions reported under CRF 2.A.1	4-20
Table 4-4: Emission Factors considered	4-23
Table 4-5: Uncertainty values related to emissions reported under CRF 2.A.2 – dedicated plants	4-25
Table 4-6: Uncertainty values related to emissions reported under CRF 1.A.2.f.....	4-26
Table 4-7: Emission Factors	4-28
Table 4-8: Uncertainty values related to emissions reported under CRF 2.A.2 – Iron and Steel.....	4-30
Table 4-9: Emission Factors	4-31
Table 4-10: Uncertainty values related to emissions reported under CRF 2.A.2 – paper pulp.....	4-32
Table 4-11: Emission Factors	4-33
Table 4-12: Uncertainty values – other sectors.....	4-34
Table 4-13: Emission Factors	4-36
Table 4-14: Uncertainty values related to emissions reported under CRF 2.A.3 – Glass Production	4-38
Table 4-15: Uncertainty values related to emissions reported under CRF 1.A.2.f.....	4-39
Table 4-16: Emission Factors	4-40
Table 4-17: Uncertainty values related to emissions reported under CRF 2.A.3 – Glass Wool Production ..	4-41
Table 4-18: Emission Factors of raw materials.....	4-43
Table 4-19: Uncertainty values.....	4-45
Table 4-20: Emission factors of soda ash	4-47
Table 4-21: Uncertainty values.....	4-48
Table 4-22: Recalculations in CO ₂ emissions for Other uses of soda ash.....	4-49
Table 4-23: Emission factors of carbonate materials	4-52
Table 4-24: Uncertainty values.....	4-53
Table 4-25: Emission Factors	4-54
Table 4-26: Uncertainty values related to emissions reported under CRF 2.A.4.d – Rock Wool Production ..	4-55
Table 4-27: Emission Factors and parameters considered.....	4-59
Table 4-28: Uncertainty values.....	4-60
Table 4-29: Emission Factors considered	4-62
Table 4-30: Uncertainty values.....	4-63
Table 4-31: CO ₂ emission factors related to TiO ₂ production	4-65
Table 4-32: Uncertainty values.....	4-65



Table 4-33: Emission Factors	4-67
Table 4-34: Uncertainty values.....	4-67
Table 4-35: Emission Factors for Carbon Black process emissions	4-70
Table 4-36: Reporting of Other Petrochemical and Carbon Black Production.....	4-71
Table 4-37: Emission streams for iron and steel industry	4-76
Table 4-38: Emission Factors for Iron and Steel Production in the period 1990-2001	4-78
Table 4-39: Carbon bearing materials: carbon content and CO ₂ stoichiometric EF.....	4-79
Table 4-40: Uncertainty values related to emissions reported under CRF 2.C.1	4-81
Table 4-41: CO ₂ emission factor related to Lead production	4-83
Table 4-42: Uncertainty values.....	4-84
Table 4-43: Emission factors for Lubricant Use (2.D.1)	4-86
Table 4-44: Uncertainty values.....	4-87
Table 4-45: Emission factors for Paraffin Waxes Use.....	4-88
Table 4-46: Uncertainty values.....	4-88
Table 4-47: Overall parameters applied for 2.F sub-categories reported.....	4-95
Table 4-48: Emission Factors considered in assemblage	4-97
Table 4-49: Emission Factors for F-gas emissions from commercial refrigeration equipment (hypermarkets not included)	4-98
Table 4-50: Emission Factors for F-gas emissions in hypermarkets.....	4-98
Table 4-51: Use of each Gas/Mixture in the assembled units (%) - HFC _y	4-99
Table 4-52: Number of refrigeration equipment per commercial unit in Portugal	4-100
Table 4-53: Number of refrigeration equipment per commercial unit in Portugal	4-101
Table 4-54: Classification of refrigeration equipment by area.....	4-101
Table 4-55: Stand-alone commercial units (Hypermarkets equipment not included).....	4-102
Table 4-56: Medium & Large commercial units (Hypermarkets equipment)	4-102
Table 4-57: Emission Factors and parameters of F-gases from Domestic Refrigeration equipment.....	4-103
Table 4-58: Domestic Refrigeration – Fridge.....	4-107
Table 4-59: Domestic Refrigeration –Freezers	4-107
Table 4-60: Industrial Refrigeration emission factors	4-112
Table 4-61: Industrial Refrigeration.....	4-113
Table 4-62: Transport Refrigeration emission factors.....	4-115
Table 4-63: Uncertainty parameters for Transport Refrigeration.....	4-117
Table 4-64: Mobile Air Conditioning emission factors and parameters for Road Transportation.....	4-119
Table 4-65: Mobile Air Conditioning emission factors and parameters for Railways.....	4-120



Table 4-66: AC shares considered to characterize the national vehicle fleet, by type of vehicle and EURO-Standard	4-121
Table 4-67: Passenger cars and light duty vehicles	4-125
Table 4-68: Heavy duty vehicles	4-126
Table 4-69: Buses and Coaches	4-126
Table 4-70: Railways	4-126
Table 4-71: Stationary Air Conditioning emission factors	4-127
Table 4-72: Use of each Gas/Mixture in the assembled equipment (%).....	4-128
Table 4-73: Residential AC.....	4-130
Table 4-74: Small Chillers	4-130
Table 4-75: Medium Chillers.....	4-130
Table 4-76: Large Chillers (Shopping Centres).....	4-131
Table 4-77: Large Chillers (Others)	4-131
Table 4-78: Foam losses emission factors	4-133
Table 4-79: Foam Blowing (Closed Cell)	4-133
Table 4-80: Foam Blowing (Open Cell)	4-134
Table 4-81: Fire Protection losses emission factors	4-136
Table 4-82: Fire protection	4-137
Table 4-83: Metered Dose Inhalers	4-139
Table 4-84: Other Aerosols.....	4-141
Table 4-85: Average SF6 charge for each kind of equipment	4-147
Table 4-86: Electric Equipment.....	4-147
Table 4-87: Emission Factors for paper pulp production (non-combustion)	4-151
Table 4-88: Emission factors of carbonate materials	4-153
Table 4-89: Uncertainty values.....	4-153

List of Equations

Equation 4-1: CO ₂ emissions from clinker production – 2005-onwards	4-17
Equation 4-2: CO ₂ emissions from clinker production – 1990-2004	4-18
Equation 4-3: Chemical conversion equations	4-21
Equation 4-4: CO ₂ Emissions from lime production – 2005-onwards	4-22
Equation 4-5: CO ₂ Emissions from lime production – 1990-2004	4-22
Equation 4-6: CO ₂ Emissions from lime production in iron and steel	4-27



Equation 4-7: Lime production estimated for 1990 and 1995-2001.....	4-28
Equation 4-8: Chemical conversion equations.....	4-30
Equation 4-9: CO ₂ Emissions from carbonates consumption in paper pulp	4-30
Equation 4-10: CO ₂ Emissions from lime production in other sectors.....	4-33
Equation 4-11: CO ₂ Emissions from glass production	4-35
Equation 4-12: CO ₂ Emissions from crystal glass production.....	4-35
Equation 4-13: Carbonate consumption – 1990-2004	4-37
Equation 4-14: CO ₂ Emissions from glass production	4-40
Equation 4-15: Annual national carbonate consumption in ceramics – 2015-onwards.....	4-42
Equation 4-16: Annual national CO ₂ emissions from ceramics – 2015-onwards.....	4-42
Equation 4-17: EU-ETS carbonates consumption - 1990-2014	4-42
Equation 4-18: Annual national carbonate consumption – 1990-2014.....	4-43
Equation 4-19: Annual national CO ₂ emissions from ceramics - 1990-2014.....	4-43
Equation 4-20: Soda ash apparent consumption	4-46
Equation 4-21: Soda ash apparent consumption in other sectors.....	4-47
Equation 4-22: CO ₂ Emissions from soda ash consumption (other sectors).....	4-47
Equation 4-23: Chemical conversion equations.....	4-50
Equation 4-24: CO ₂ emissions.....	4-51
Equation 4-25: CO ₂ emissions.....	4-51
Equation 4-26: SO ₂ removals.....	4-51
Equation 4-27: CO ₂ Emissions from rock wool production	4-54
Equation 4-28: Limestone consumption - 1997-2004	4-55
Equation 4-29: Chemical conversion equation.....	4-57
Equation 4-30: Chemical conversion equation.....	4-57
Equation 4-31: Chemical conversion equations.....	4-58
Equation 4-32: CO ₂ emissions from ammonia production.....	4-59
Equation 4-33: CO ₂ recovered for urea production	4-59
Equation 4-34: N ₂ O Emissions from nitric acid production.....	4-62
Equation 4-35: CO ₂ emissions from titanium dioxide production	4-64
Equation 4-36: CO ₂ and CH ₄ emissions from ethylene production	4-66
Equation 4-37: Emissions from black carbon production	4-69
Equation 4-38: Carbon mass balance	4-69
Equation 4-39: Emissions from sinter production.....	4-77
Equation 4-40: Emissions from iron and steel (BOF) production.....	4-77



Equation 4-41: Emissions from steel production (EAF) – 1990-2001.....	4-78
Equation 4-42: Sinter production in the integrated iron and steel facility	4-79
Equation 4-43: EAF steel production in the integrated iron and steel facility – 1990-2001	4-80
Equation 4-44: CO ₂ emissions from lead production	4-83
Equation 4-45: Lubricants accounted for in this category	4-85
Equation 4-46: CO ₂ emissions from lubricants consumption.....	4-86
Equation 4-47: CO ₂ emissions from paraffin wax consumption.....	4-87
Equation 4-48: Emissions when charging new equipment	4-96
Equation 4-49: Emissions during equipment lifetime	4-96
Equation 4-50: Emissions at system end-of-life (Disposal)	4-97
Equation 4-51: Emissions when charging new equipment	4-111
Equation 4-52: Emissions during equipment lifetime	4-111
Equation 4-53: Emissions at system end-of-life (Disposal)	4-112
Equation 4-54: Emissions when charging new equipment	4-114
Equation 4-55: Emissions during equipment lifetime	4-114
Equation 4-56: Emissions at system end-of-life (Disposal)	4-115
Equation 4-57: Emissions when charging new MAC equipment.....	4-118
Equation 4-58: Emissions during MAC equipment lifetime	4-118
Equation 4-59: Emissions at MAC system end-of-life (Disposal).....	4-119
Equation 4-60: Annual stocks	4-127
Equation 4-61: First year losses.....	4-132
Equation 4-62: F-gas in closed-cell	4-132
Equation 4-63: Annual losses	4-132
Equation 4-64: Emissions during equipment lifetime	4-134
Equation 4-65: Bank of F-gas.....	4-135
Equation 4-66: Disposal emissions	4-135
Equation 4-67: Amount of F-gas in equipment at disposal phase	4-135
Equation 4-68: F-gas emissions from metered dose inhalers	4-139
Equation 4-69: 2015 Portuguese activity data for other aerosols	4-140
Equation 4-70: Portuguese activity data for other aerosols for year y.....	4-140
Equation 4-71: F-gas emissions from other aerosols	4-140
Equation 4-72: SF ₆ emissions from manufacture of electrical equipment.....	4-142
Equation 4-73: Correspondent States Principle	4-144
Equation 4-74: SF ₆ emissions.....	4-145



Equation 4-75: Emissions from Pulp and Paper Industry	4-150
Equation 4-76: CO ₂ emissions.....	4-153



4 Industrial Processes and Products Use (CRF Sector 2)

Rita Silva

Updated: March 2023

4.1 Overview of the sector

Industrial Processes and Product Use (IPPU) sector generates GHG emissions resulting from the chemical and physical transformation of raw materials in the industrial transformation processes, excluding emissions that result from combustion processes aiming for energy production¹. GHG emissions also result from the use of greenhouse gases in products and from non-energy uses of fossil fuel carbon. According to UNFCCC reporting guidelines, in this sector are also included emissions of fluorinated compounds (HFC, PFC and SF₆) that are used in different applications - not solely industrial, but also in domestic and services sector - as substitutes to ozone depleting substances (ODS).

Industrial processes, either involving combustion or not, result also in the release of other atmospheric pollutants like acidifying gases and indirect GHG: NO_x, NMVOC and SO_x. Industrial processes are also relevant sources of particulate matter (TSP, PM₁₀, PM_{2.5} and PM₁) and local air pollutants such CO and Heavy Metals. The methodologies and emission factors that are used in the Portuguese air emission inventory for estimating emissions from these sources are discussed in the Inventory Informative Report (IIR)².

The year of 2021 was globally marked by the slow recovery of the negative impact caused by COVID-19 pandemic in 2020 on national economy, which had led to a strong contraction in the vast majority of the economic activity branches, leading in some cases to almost total paralysis. In 2021, industrial production increased approximately 12% compared to 2020. The greatest contributions to the increase of total sales of products and provision of services resulted from the manufacturing of chemical products and synthetic or artificial fibres except pharmaceutical products, followed by the metallurgical industries and refined petroleum products and fuel agglomerates (Source: National Statistics - "Industrial Production Statistics 2021"). The figure below presents the contribution of IPPU's emissions in the country's total GHG emissions in 2021.

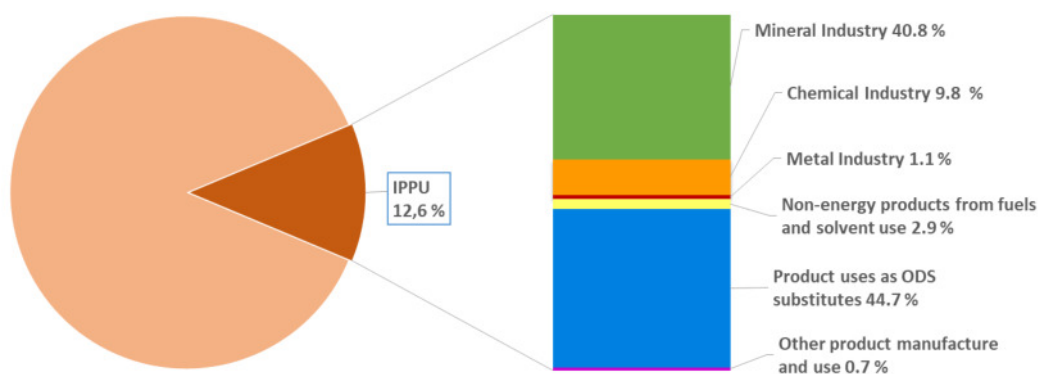

Figure 4-1: IPPU emissions from total GHG emissions in 2021, by source sub-sector

¹ Emissions from combustion are considered in this sector if they are considered a production process and not as a way to obtain energy, even if the energy is used directly in the production process such as in a furnace. Emissions from combustion processes in industry with the sole purpose of obtaining energy (boilers, furnaces, engines) are included in the Energy sector.

² IIR is the report of emissions elaborated under the reporting obligations of the Convention on Long Range Transboundary Air Pollution (CLRTAP) of the UNECE. It will be available also in <https://apambiente.pt/>.



The table below presents total GHG emissions from IPPU, by sector and by gas.

Table 4-1: Total GHG emissions from IPPU

Source /Gas	Base Year ³	2005	2019	2020	2021	Δ	Δ	Δ
						2021-2020	2021-2005	2021-Base Year
						kt CO ₂ e		
						%		
2.A Mineral Industry								
CO ₂	3,671.6	4,920.8	3,071.6	3,067.1	2,910.9	-5.1%	-40.8%	-20.7%
2.B Chemical Industry								
CO ₂	1,408.5	1,523.8	639.6	622.6	637.6	2.4%	-58.2%	-54.7%
CH ₄	28.6	30.0	30.3	29.6	30.2	2.2%	0.7%	5.7%
N ₂ O	460.4	496.4	32.1	30.1	33.2	10.6%	-93.3%	-92.8%
2.C Metal Industry								
CO ₂	446.2	109.2	93.8	96.6	78.0	-19.3%	-28.6%	-82.5%
CH ₄	0.7	-	-	-	-	-	-	-
2.D Non-energy products from fuels and solvent use								
CO ₂	242.4	230.5	185.2	207.2	205.2	-0.9%	-11.0%	-15.3%
2.F Product uses as ODS substitutes								
HFC	54.2	984.7	3,129.9	3,086.3	3,159.0	2.4%	220.8%	5729.2%
PFC	0.1	3.3	21.3	23.8	26.5	11.7%	696.9%	27626.4%
2.G Other product manufacture and use								
N ₂ O	73.7	52.0	42.4	26.3	27.3	3.9%	-47.6%	-63.0%
SF ₆	14.4	27.5	24.8	23.6	24.2	2.5%	-11.8%	68.6%
Total								
CO ₂	5,768.8	6,784.3	3,990.2	3,993.4	3,831.6	-4.1%	-43.5%	-33.6%
CH ₄	29.3	30.0	30.3	29.6	30.2	2.2%	0.7%	3.2%
N ₂ O	534.1	548.4	74.5	56.3	60.5	7.4%	-89.0%	-88.7%
HFC	54.2	984.7	3,129.9	3,086.3	3,159.0	2.4%	220.8%	5729.2%
PFC	-	3.3	21.3	23.8	26.5	11.7%	696.9%	-
SF ₆	14.4	27.5	24.8	23.6	24.2	2.5%	-11.8%	68.6%
Total								
All gases (Base Year 1990)	6,332.2	8,378.2	7,271.1	7,213.0	7,132.1	-1.1%	-14.9%	12.6%

Note: Totals may not sum due to independent rounding. Emissions values are presented in kt CO₂e mass units using IPCC AR5 GWP values (please consult Table 1-1 in Chapter 1).

Total GHG emissions from this source sector have increased from about 6.3 Mt CO₂e in 1990 to 7.1 Mt CO₂e in 2021, as may be seen in the table above, representing an increase of about 13 % when compared to 1990⁴.

The majority of emissions, expressed in CO₂e, are associated with Products Uses as ODS substitutes (2F), responsible for 0.8 % of total emissions from this sector in 1995, and about 45 % of total emissions from this sector in 2021, as may be seen in the figure below. The remaining sub-source sectors (2A, 2B, 2C, 2D, 2E, 2G and 2H) contribute about 55 % of total emissions in 2021.

³ Base Year refers to 1990 for all GHG with the exception of F-gases (HFC, PFC and SF₆), which refers to 1995.

⁴ Base year for F-gases reporting is, however, 1995.

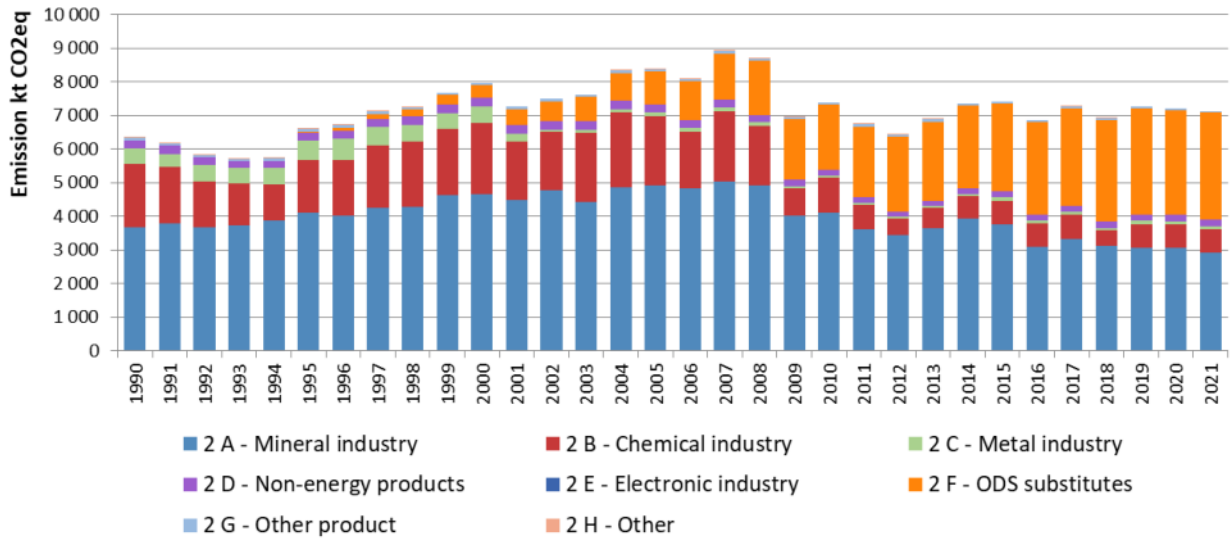

Figure 4-2: Total GHG emissions from IPPU per source sub-sector (kt CO₂e)

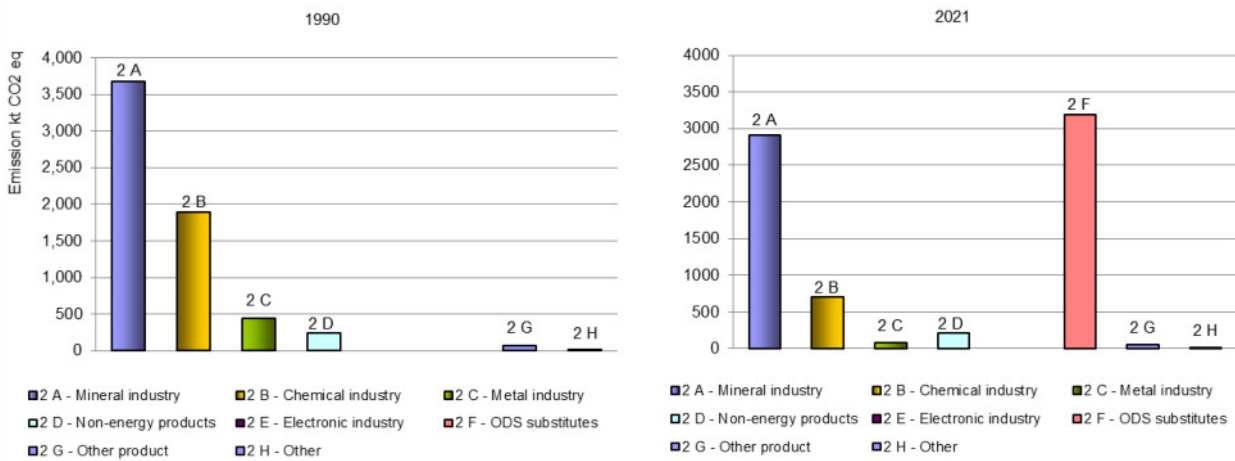

Figure 4-3: Emissions of Industrial processes by sub-source sector in Portugal in year 1990 and 2021 (kt CO₂e)

The majority of GHG emissions in IPPU sector is released directly as CO₂, while N₂O represents a smaller proportion of emissions and CH₄ emissions are a non-relevant part, as may be seen in the figure below. Fluorinated gases have become a relevant source of GHG emissions in IPPU sector.

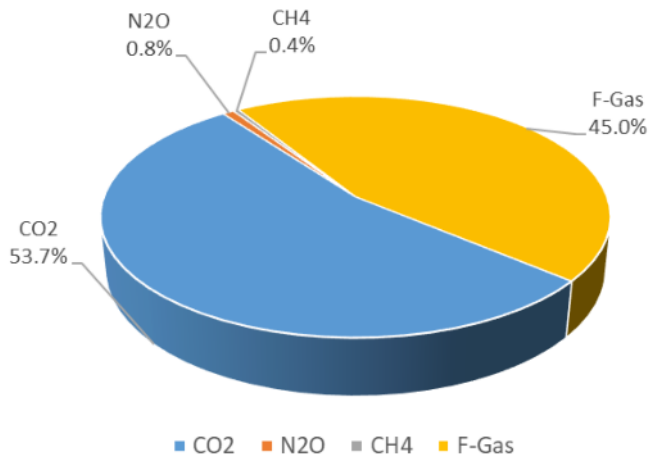

Figure 4-4: GHG Emissions from IPPU per gas in 2021



Recalculations

2.A.3 (Glass Production): correction of allocation errors regarding carbonates consumption time series were for the period 1990-2018;

2.A.4.a (Other Uses of Carbonates in Ceramics): correction of allocation errors regarding carbonates consumption time series for the whole time series;

2.A.4.b (Other Uses of Soda Ash): Consumption activity data was revised for the whole time series; imports data were revised from 2010 onwards; exports data were updated from 2013 onwards;

2.B.8.c (Ethylene Dichloride and Vinyl Chloride Monomer (VCM)): activity not occurring in the country, for the whole time series;

2.B.8.g (Other Petrochemical Production): Activity data update for minor sub-categories (please consult IIR 2023);

2.C.5 (Lead Production): Activity data update in 2020;

2.D.1 (Lubricants use): Two-stroke engines lubricants consumption data were updated for 1994-2020;

2.D.3.a (Domestic Solvent Use): Activity data update for minor sub-categories (please consult IIR 2023);

2.D.3.c (Urea based catalytic converters): Activity data were updated for 2007-2020;

2.E (Electronics Industry): Notation keys updated for all sub-sectors for the whole time series;

2.F.1.b (Domestic Refrigeration): Activity data was updated for the whole time series;

2.F.1.e (Mobile Air Conditioning): Data on vehicle fleet stock was updated for 1994-2020;

2.G.1 (Electrical Equipment): Activity data update for year 2020;

Several minor sub-categories: Update on surrogate data such as Gross Domestic Product (GDP) and Gross Value Added (GVA) for 2020.

Key categories

The key categories in IPPU are summarised in the tables below.

Table 4-2: Key categories in IPPU (CRF 2) and methodologies used in emission estimates

IPCC category	Gas	Criteria	Method
2.F.1 Refrigeration and Air Conditioning	F-gases	L	T2,T1
2.A.1 Cement Production	CO ₂	L,T	T3,T1
2.B.8 Petrochemical and Carbon Black Production	CO ₂	L	T1,T3
2.A.2 Lime Production	CO ₂	L,T	T3,T1
2.A.4 Other Process Uses of Carbonates	CO ₂	L	T3,T1
2.D Non-energy products from fuels and solvent use	CO ₂	L	T2
2.C.1 Iron and Steel	CO ₂	L,T	T3,T1
2.B.2 Nitric Acid Production	N ₂ O	L,T	T1, T3



4.2 Mineral Industry (CRF 2.A)

4.2.1 Overview

This chapter is intended to estimate process-related carbon dioxide (CO₂) emissions resulting from the use of carbonate raw materials in the production and use of a variety of mineral industry products. There are two broad pathways for release of CO₂ from carbonates: calcination and the acid-induced release of CO₂. The primary process resulting in the release of CO₂ is the calcination of carbonate compounds, during which, through heating, a metallic oxide is formed. According to the 2006 IPCC Guidelines, although methane (CH₄) and nitrous oxide (N₂O) may be emitted from some minerals industry source categories, given current scientific knowledge, these emissions are assumed to be negligible and thus are not addressed in this chapter.

4.2.2 Cement Production (CRF 2.A.1)

4.2.2.1 Category description

This sector is identified as key-category for CO₂ emissions.

There are six cement production plants operating in Portugal, mostly dedicated to Portland cement production⁵ and almost all located in the southern half of the country. Five of these clinker producing units use the dry process while the remaining one uses both the dry and the semi-wet process, although the dry process is prevalent in that unit too. All dry process units have short kilns with pre-heaters, and 5 kilns in four units are provided with pre-calciners⁶.

In cement production, CO₂ emissions occur during the production of clinker, specifically from the conversion of CaCO₃ and MgCO₃, the main constituents of limestone, to lime (CaO) and magnesia (MgO), leaving CO₂ as by product to atmosphere (decarbonisation).

Other types of carbonate inputs for Portugal's cement industry are sand, malm, mixed carbonate and dolomite, kaolin, limestone cream, sludge with limestone, however, these are considered to be negligible sources of emissions.

Category 2.A.1 only reports CO₂ emissions from limestone decarbonizing. CO₂ emissions from liberation of carbon in fuel during combustion are addressed in the Energy chapter (3.4 - Manufacturing Industries and Construction) and reported in the Energy sector (CRF 1.A.2). Emissions of other pollutants, although might result from both fuel and raw material, are also addressed in the Energy chapter and reported in the Energy sector, for simplicity sake. However, although combustion emissions and process emissions are estimated separately, they are in fact emitted at same place and are inseparable in concept.

4.2.2.2 Methodology

Since there are different data sources available depending on the years, two different methodologies were used throughout the time series.

Since 2005, when European Union Emissions Trading System (EU ETS) was set up, clinker production process emissions are estimated by the facilities according to Method A (Kiln Input based) from No. 9 of Annex IV of Regulation (EU) No. 2066/2018 (<https://eur-lex.europa.eu/legal-content/pt/TXT/?uri=CELEX%3A32018R2066>). Emissions are estimated with a Tier 3 methodology, based on raw meal consumption and the respective emission factor, which are determined in laboratory and provided by the facilities.

⁵ There is also some production of white Portland cement, which is characterized by a lower iron and manganese constant than grey cement, and it is used mainly for decorative purposes (EPA, 1995). In Portugal, there are also smaller additional cement plants that do not produce clinker.

⁶ One calciner is a false pre-calciner.



From 2005-onwards, the following equation is used:

Equation 4-1: CO₂ emissions from clinker production – 2005-onwards

$$Emi_{CO_2} = M_i \times EF_i \times F_i - M_d \times C_d \times (1 - F_d) \times EF_d + M_k \times X_k \times EF_k$$

Where:

Emi_{CO₂}: Emissions of CO₂ from clinker production (kt)

M_i: Mass of raw meal kiln input (t)

EF_i: Emission factor of raw meal kiln input (kt CO₂/t of raw meal)

F_i: Fraction calcination achieved for raw meal kiln input (0 to 1)

M_d: Mass of CKD (Cement Kiln Dust) not recycled to the kiln (t)

C_d: Fraction of original carbonate in the CKD not recycled to the kiln (0 to 1)

F_d: Fraction calcination achieved for CKD not recycled to the kiln (0 to 1)

EF_d: Emission factor of the uncalcined carbonate in CKD not recycled to the kiln (kt CO₂/t of carbonate)

M_k: Mass of organic carbon-bearing non-fuel raw meal (t)

X_k: Fraction of total organic carbon in specific non-fuel raw meal (0 to 1)

EF_k: Emission factor for organic carbon-bearing non-fuel raw meal (kt CO₂/t of raw meal)

Considering the temperatures achieved and the residence time in the kilns, it is assumed complete carbonates calcination (100%), hence the conversion factor F_i is 1.

During the manufacture of clinker, CKD is generated in various points of the process and captured by dust control technology.

Until 2019, in the Portuguese cement facilities, all CKD captured was recycled to the kilns or raw meal storage silos and, therefore, accounted for in emissions estimation through a correction in raw meal consumption (M_i). This correction is performed by each facility and is based on the raw meal weighted before the kilns and a recirculation factor.

As of 2020, EU-ETS approved the methodology for accounting bypass dust emissions in clinker production facilities, which began being reported as a separate raw material input. This part of the raw meal, which is not fully calcined, upon entering the pre-heater equipment, is dragged along with the exhaust gases and captured by specific dust control technology. Hence, this amount has to be deducted from raw meal consumption and has a significantly lower emission factor. This part of CKD does not return to the storage silos or the kilns (due to excessive alkali content), instead is captured and stored separately for future marketing.

CO₂ emissions from non-carbonate carbon in the non-fuel raw materials are also accounted for in total CO₂ process emissions. However, non-carbonate carbon represents a fraction between 0,15% and 0,35% of raw meal weight, therefore may be ignored in the Energy sector. Plus, these emissions cannot be disaggregated from total CO₂ emissions calculated by each facility.

Given there is no EU-ETS system in the period 1990 to 2004, the splicing technique “overlap” (section 5.3.1.1 of Vol.1 of the 2006 IPCC Guidelines) was used in order to estimate CO₂ emissions from clinker production, according to the following equation:

**Equation 4-2: CO₂ emissions from clinker production – 1990-2004**

$$Emi CO_{2,y} = Clinker Prod_y \times \frac{Emi CO_{2,2005-2009}}{Clinker Prod_{2005-2009}}$$

Where:

Emi_{CO₂,y}: Emissions of CO₂ in year y (kt)

Clinker Prod_y: Clinker production in year y (t)

Emi CO_{2, 2005-2009}: Average CO₂ emissions in period 2005-2009 (kt CO₂)

Clinker Prod₂₀₀₅₋₂₀₀₉: Average Clinker production in period 2005-2009 (t)

From 1990 to 2004, clinker production (Clinker Prod_y) was obtained from the facilities.

In order to ensure time series consistency between the two methodologies, CO₂ emissions for the period 1990-2004 (Emi CO₂y) were based on the ratio between the average EU-ETS CO₂ emissions in the period 2005-2009 and the average clinker production in the period 2005-2009.

EU-ETS CO₂ emissions in the period 2005-2009 were obtained from EU-ETS according to Equation 4-2. Clinker production in the period 2005-2009 was obtained from the facilities.

For the 1994-2004 data overlap, we decided to fix the data used as the average of the period 2005-2009, in order to avoid yearly corrections associated to the introduction of last year ratios and given it is the closest period with available and reliable data.

4.2.2.3 Emission Factors

From 2005 to 2012, we have used plant specific raw meal carbon content characterization to estimate CO₂ emissions based on raw meal consumption in the kilns. This information was obtained from the facilities.

From 2013 onwards, cement facilities in EU-ETS system were obliged to measure CO₂ emission factors in laboratory from representative samples of the raw meal. The method used is based on the direct calculation of the CO₂ emitted through heating process, between 500 and 975 Celsius degrees. The error associated with this determination lies in the fact that the organic carbon present in the raw meal will also be accounted for as CO₂. However, since this content is always very low (approximately 0,1%), the error can be considered to be lower than that of which would result from the calculation of emissions based on the determination of Ca and Mg contents in the form of carbonates.

From 2005 to 2009 we have estimated plant specific average ratio between CO₂ emissions and clinker production for each facility and used this average value to back cast CO₂ emissions in the period 1990-2004, taking also into consideration clinker production for each facility in the period 1990-2004. We decided to fix the data used to the retropolation as the average of the period 2005-2009 in order to avoid yearly corrections associated to the introduction of last year ratios.

The fluctuation in the implied emission factor (IEF) from 2005 onwards is due to changes in raw meal carbon content.

4.2.2.4 Activity Data

From 2005 onwards, EU-ETS data on raw meal consumption is used.

We do not have access to disaggregated data on the types and quantities of carbonates consumed to produce clinker, as well as their emission factors, as recommended in Tier 3 methodology of 2006 IPCC Guidelines.



Due to the existence of Ca and Mg in non-carbonated form in raw meal, CO₂ emission estimates through Ca and Mg analysis would generate several uncertainties due to the need to account for all individual parcels and to carry out on each of them the corresponding analysis.

CO₂ process emissions would thus be overestimated. Hence, since it was not possible to dissociate the carbonates in non-carbonated form, it was decided to use the amount of raw meal.

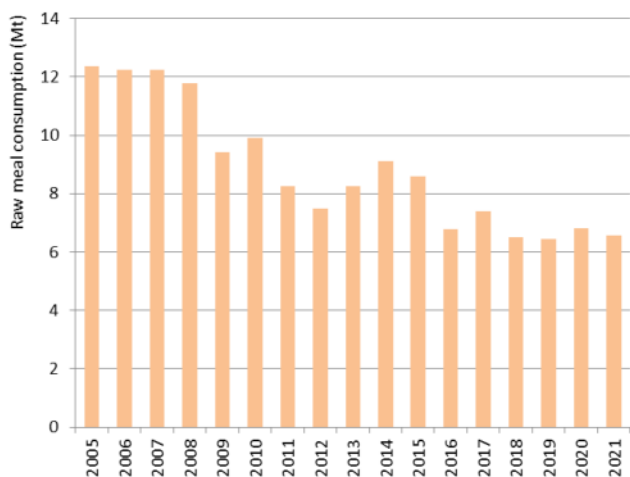

Figure 4-5: Raw meal consumption in Portugal

Clinker production was obtained directly from each facility for the whole time series, and the correspondent time series may be observed in next figure.

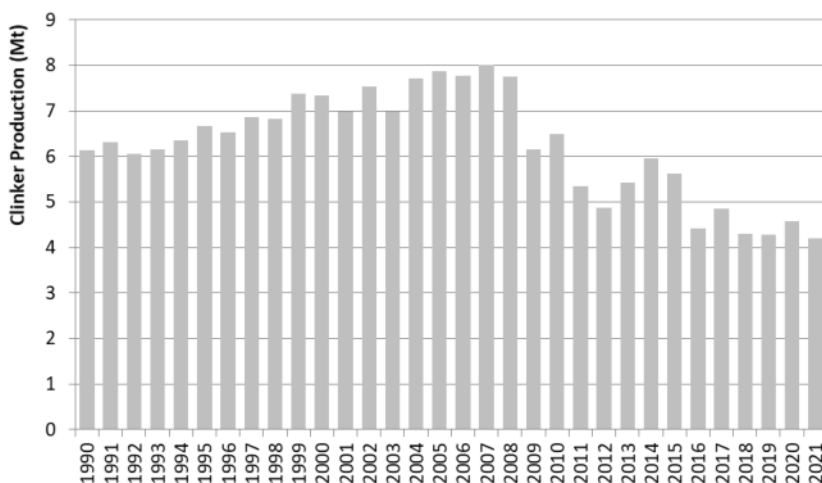

Figure 4-6: Total clinker production in Portugal

The decrease from 2008 to 2012 is due to a demand decrease in Portugal, Spain and North Africa market. From 2013 to 2014 there is an overall increase in clinker production of 0.54 Mt due to exports rise to Africa and South America. In 2015-2016 there is a sharp decrease on clinker production, due to a contraction of external market sales, related both to supply excess in the Mediterranean area and to a consumption decrease in Africa.



4.2.2.5 Uncertainty Assessment

Table 4-3: Uncertainty values related to emissions reported under CRF 2.A.1

Parameter	Type of Uncertainty	Uncertainty	Source
Activity Data	Composition	7.0%	Table 2.3 of "Chapter 2: Mineral Industry Emissions" of "2006 IPCC Guidelines for National Greenhouse Gas Inventories": 2% - Kerogen (or other non-carbonate carbon) determination: 2% - Overall chemical analysis pertaining to carbonate content (mass) & type: 3% - Assumption that carbonate species is 100% CaCO ₃
Activity Data	Uncertainty of plant-level weighing of raw materials	2.0%	Table 2.3 of "Chapter 2: Mineral Industry Emissions" of "2006 IPCC Guidelines for National Greenhouse Gas Inventories".
Activity Data	Uncertainty on CKD	30.0%	Table 2.3 of "Chapter 2: Mineral Industry Emissions" of "2006 IPCC Guidelines for National Greenhouse Gas Inventories":
Activity Data	Combined Uncertainty	30.9%	-
CO ₂ EF	Combined Uncertainty	1.4-5.4%	Uncertainty = [(Highest-Lowest)/Average/2]X100 Data on CO ₂ emissions obtained from ETS.

Uncertainty estimates based on fuel consumption are reported under CRF 1.A.2.f.

4.2.2.6 Category specific QA/QC and verification

Emissions estimates were based on a bottom-up approach with collection of plant specific clinker production data. A comparison was made using a top-down approach based on clinker production data obtained from national production statistics (IAPI) from 1992 onwards. There are slight differences using the two different approaches but, generally, data is consistent.

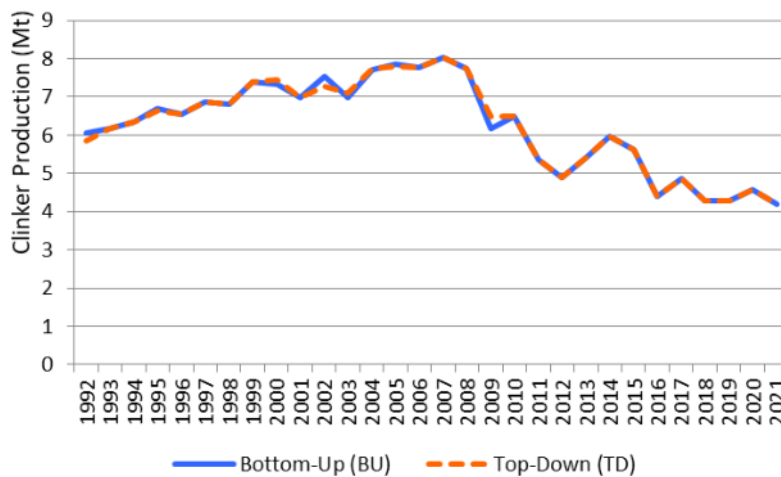

Figure 4-7: Clinker production data – comparison of approaches

When cross-checking 2020 EU-ETS data (process emissions) for cement production with 2020 clinker production data from the facilities, it was noticed a deviation of about 3% from the IEF average value compared to previous years. Following contacts with the Portuguese EU-ETS team, we learned that they had already contacted clinker facilities regarding this issue, providing the following main clarifications:

- . CO₂ emissions from clinker production are estimated based on a Tier 3 approach, where the weights and compositions of all carbonate inputs from all raw material and fuel sources, emission factors for the carbonates, and the fraction of calcination achieved accounted for and reported by the facilities to the EU-



ETS. Overall, in 2020 the majority of facilities consumed raw material with less carbonate content, thus, reducing carbon content in raw meal and limiting CO₂ emissions from calcination;

. Also in 2020, dust control technology was fine-tuned, consequently capturing CKD (cement kiln dust) more efficiently. Therefore, there was an increase in the amount of CKD captured and recycled to the storage silos, thus resulting in an increase in the recirculation factor and a decrease in raw meal consumption correction;

. Finally, in 2020 EU-ETS approved the methodology for accounting of bypass dust emissions in clinker production facilities, which began being reported as a separate raw material input. This material, which is not fully calcined, is generated in the pre-heater equipment, dragged along with the exhaust gases and captured by specific dust control technology. Hence, this amount has to be deducted from raw meal consumption and has a significantly lower emission factor, which contributes to a slight decrease in CO₂ emissions. This dust does not, however, return to the storage silos or the kilns, instead is captured and stored separately for future marketing.

4.2.2.7 Recalculations

No recalculations were made.

4.2.2.8 Further Improvements

No further improvements are planned.

4.2.3 Lime Production in dedicated plants (CRF 2.A.2)

4.2.3.1 Category description

Lime is produced through calcination in a kiln, a process of thermal conversion (at temperatures at about 900-1200 Celsius degrees) of carbonate bearing materials (mostly limestone and dolomite, but aragonite, chalk, marble or sea shells could be also used) releasing carbon dioxide and leaving lime (CaO) or magnesia (MgO) as valuable products. The following chemical conversion equation applies, where for each mol of oxide produced a mol of carbon dioxide is emitted:

Equation 4-3: Chemical conversion equations

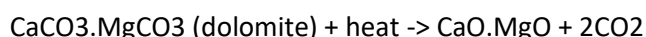
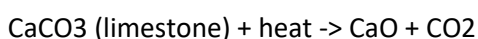

Lime products include several different forms:

- Quicklime or high calcium lime: a material composed of calcium oxide (CaO), it is produced by heating limestone with heavy CaCO₃ content (at least 50 %) to high temperatures. It is used in construction, agriculture and chemical processes (manufacture of Na₂CO₃, NaOH, steel, refractory material, SO₂ absorption, CaC₂, glass, pulp and paper, sugar and ore concentration and refining). It is also used in waste and water treatment;
- Dolomite quicklime: produced in a similar mode to quicklime but from dolomitic limestone or magnesite rocks that contain both calcium carbonate and magnesium carbonate (MgO is usually around 30 to 45 % in content). Dolomite quicklime is a mixture of CaO and MgO;
- Calcium Hydroxide, slaked lime, dead lime, burned lime or hydrated lime: Ca(OH)₂ it is produced from CaO and water. When an equivalent quantity of water is used is called slaked lime, when an excess water is used is milk of lime and a clear solution of Ca(OH)₂ in water is limewater. It is used as an industrial



alkali and in the preparation of mortar (slaked lime plus sand) which sets to solid by reconversion of the hydroxide to CaCO₃ (Sharp, 1981);

- Hydraulic Lime: a mixture of calcium oxide (CaO) and silicates, it is an intermediate product between lime and cement.

There are 5 dedicated lime production plants under ETS in Portugal.

4.2.3.2 Methodology

Since 2005, when European Union Emissions Trading System (EU ETS) was set up, CO₂ process emissions from lime production are Kiln Input based, estimated by the facilities according to No. 10 of Annex IV of Regulation (EU) No. 2066/2018 (<https://eur-lex.europa.eu/legal-content/pt/TXT/?uri=CELEX%3A32018R2066>). Calculation is based on the amount of carbonates in the raw materials consumed (Tier 3), according to the following equation:

Equation 4-4: CO₂ Emissions from lime production – 2005-onwards

$$Emi_{CO_2} = M_i \times EF_i \times F_i - M_d \times C_d \times (1 - F_d) \times EF_d$$

Where:

Emi_{CO₂}: Emissions of CO₂ from lime production (kt)

M_i: Mass of carbonate I consumed (t)

EF_i: Emission factor of carbonate I consumed (kt CO₂/t of raw meal)

F_i: Fraction calcination achieved for carbonate i (0 to 1)

M_d: Mass of LKD (Lime Kiln Dust) not recycled to the kiln (t)

C_d: Fraction of original carbonate in the LKD not recycled to the kiln (0 to 1)

F_d: Fraction calcination achieved for LKD not recycled to the kiln (0 to 1)

EF_d: Emission factor of the uncalcined carbonate in LKD not recycled to the kiln (kt CO₂/t of carbonate)

Considering the temperatures achieved and the residence time in the kilns, it is assumed complete carbonates calcination (100 %), hence the conversion factor F_i is 1.

During lime production, LKD is generated and can be recycled directly to the kilns or captured by dust control technology and returned to the storage silos. Either way, for all 5 dedicated lime production plants, all LKD is recycled and therefore accounted for in emissions estimation, through a correction in carbonate bearing materials (M_i). This correction is performed by each facility and is based on the carbonate bearing materials weighted before the kilns and a recirculation factor of approximately 0.2%.

Given there is no EU-ETS system in the period 1990 to 2004, the splicing technique “overlap” (section 5.3.1.1 of the 2006 IPCC Guidelines) was used in order to estimate CO₂ emissions from lime production, according to the following equation:

Equation 4-5: CO₂ Emissions from lime production – 1990-2004

$$Emi_{CO_2,y} = Lime\ Prod_y \times \frac{Emi_{CO_2,2005-2009}}{Lime\ Prod_{2005-2009}}$$

Where:

Emi_{CO₂,y}: Emissions of CO₂ in year y (kt)

Lime Prod_y: Lime production in year y (t quicklime and hydraulic lime)



Emi CO_{2, 2005-2009}: Average CO₂ emissions in period 2005-2009 (kt CO₂)

Lime Prod₂₀₀₅₋₂₀₀₉: Average Lime production in period 2005-2009 (t quicklime and hydraulic lime)

From 1990 to 2004, lime production (Lime Prod_y) was obtained from National Statistics.

In order to ensure time series consistency between the two methodologies, CO₂ emissions for the period 1990-2004 (Emi CO_{2y}) were based on the ratio between the average EU-ETS CO₂ emissions in the period 2005-2009 and the average lime production in the period 2005-2009.

EU-ETS CO₂ emissions in the period 2005-2009 were obtained from EU-ETS according to Equation 4-4. National lime production in the period 2005-2009 was obtained from National Statistics.

For the 1994-2004 data overlap, we decided to fix the data used as the average of the period 2005-2009, in order to avoid yearly corrections associated to the introduction of last year ratios and given it is the closest period with available and reliable data.

4.2.3.3 Emission Factors

From 2005 to 2012, CO₂ emission factors in EU-ETS were estimated by converting kiln input materials composition data, using the following stoichiometric ratios (Table 1 of Annex VIII of Decision 2007/589/EC).

Table 4-4: Emission Factors considered

Raw Material	Unit	EF
CaCO ₃	t CO ₂ /t CaCO ₃	0.440
MgCO ₃	t CO ₂ /t MgCO ₃	0.522

From 2013 onwards, lime production facilities in EU-ETS system were obliged to measure CO₂ emission factors in laboratory from representative samples of the raw meal. The method used is based on the direct calculation of the CO₂ emitted through heating process, between 500 and 975 Celsius degrees.

From 2005 to 2009 we have estimated the average ratio between total CO₂ emissions and lime production and used this average value to back cast CO₂ emissions in the period 1990-2004, taking also into consideration total lime production in the period 1990-2004. We decided to fix the data used to the retropolation as the average of the period 2005-2009 in order to avoid yearly corrections associated to the introduction of last year ratios.

2020 UNFCCC Review identified that the implied emission factor (t CO₂/t carbonate) of one facility increased from 0.31 in the year 2009 to more than 1 in the period 2010-2013. Further analysis clarified that there were two different sources of information for carbonates consumption (PRTR and EU-ETS) in the period 2009-2013 and this might be the reason for the significant increase in the implied emission factor identified by the ERT. Portugal contacted the facility, confirming that there had been a reporting error. Therefore, in the 2021 submission, carbonates consumption values in the period 2010-2013 were corrected according to new information obtained from the facility, in order to improve time series consistency in that period.

4.2.3.4 Activity Data

From 2005 onwards, information on kiln type and LKD correction was obtained directly from the facilities.

From 2005 onwards, activity data used to estimate EU-ETS CO₂ emissions is the consumption of raw materials, obtained from EU-ETS. From 1990 to 2004 there is no available data on consumption of raw materials.

From 1990 to 2004, activity data used to estimate CO₂ emissions in lime production, obtained from National Statistics (INE) IAPI industrial survey.



Therefore, we have two different sets of activity data (raw materials and lime production) for different periods, but can only report one series in the CRF tables.

In order to ensure time series consistency of the activity data reported in the CRF tables, we collected national lime production from National Statistics for the whole time series and compared it with lime production collected from the E-PRTR (figure below). However, from E-PRTR source, we only have access to lime production data from 2010 onwards. We contacted the facilities in order to provide us lime production data for the missing years (1990-2009), however, quite many of them no longer possess those data due to company restructuration or human resources allocation.



Figure 4-8: Lime production from different sources

Given the relative consistency between the two sets of data, we decided to report in the CRF tables:

- . from 1990 to 2009 - Lime production from National Statistics (INE) IAPI industrial survey;
- . from 2010 onwards - Lime production from E-PRTR.

From 1990 to 2009 we decided to use lime production data by type of lime from INE rather than use an approximate value obtained from a splicing technique. Moreover, there is no consistent plant specific lime production data for that period. For consistency purposes, it was only considered the production of quicklime and hydraulic lime. Slaked lime amounts were not considered, because this type of lime is produced from quicklime and there are no CO₂ emissions related to calcination.

From 2010 onwards, for each lime production plant, it was gathered information on kiln type and lime production by type of lime (quicklime, hydraulic lime and slaked lime), based on annual environmental reports and on additional data provided by the facilities.

Lime production is presented in the figure below for the whole time series.

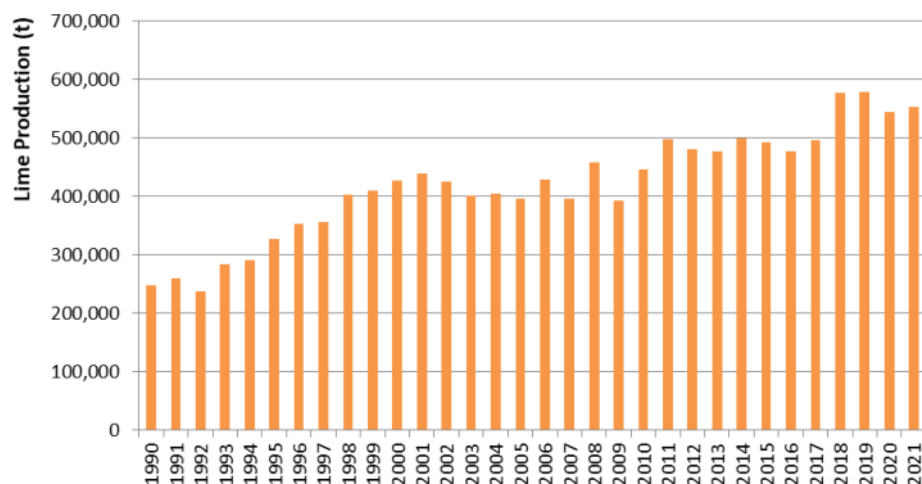

Figure 4-9: Lime production reported in the CRF tables

In the end of the second quarter of 2008, one facility terminated operation and was excluded from EU-ETS, hence the significant decrease in lime production from 2008 to 2009.

In the end of the first quarter of 2017, a new facility began operating and was included in ETS, however, it was on a pilot phase and, therefore, working intermittently. Formally, this facility only started fully operating in early 2018, hence the significant increase in lime production from 2017 to 2018. In 2020 there is a slight decrease in lime production due to COVID19 pandemic.

4.2.3.5 Uncertainty Assessment

Table 4-5: Uncertainty values related to emissions reported under CRF 2.A.2 – dedicated plants

Parameter	Type of Uncertainty	Uncertainty	Source
Activity Data	Lime production data	1.5% (average of 1.0-2.0% range)	Average of the range 1.0-2.0% of Table 2.5 of Chapter 2: Mineral Industry Emissions of 2006 IPCC Guidelines for National Greenhouse Gas Inventories.
Activity Data	Lime Production	35% (highest of 25-35% range)	Highest value of the range (25-35%) of "Default Values" of CKD/LKD in Table 2.3 of Chapter 2: Mineral Industry Emissions of 2006 IPCC Guidelines for National Greenhouse Gas Inventories.
Activity Data	Combined Uncertainty	35.03%	-
CO ₂ EF	CaO in lime	6.0% (average of 4.0-8.0% range)	Average of the range 4.0-8.0% of "Table 2.5" of "Chapter 2: Mineral Industry Emissions" of "2006 IPCC Guidelines for National Greenhouse Gas Inventories".
CO ₂ EF	EF of High Calcium Lime	2.0%	"Emission factor high calcium lime" (2%) of "Table 2.5" of "Chapter 2: Mineral Industry Emissions" of "2006 IPCC Guidelines for National Greenhouse Gas Inventories".
CO ₂ EF	Combined Uncertainty	6.3%	-



Table 4-6: Uncertainty values related to emissions reported under CRF 1.A.2.f

Parameter	Fuel Type	1990-2004	2005-2007	2008 onwards
Activity Data	L	10% ⁽ⁱ⁾	3% ⁽ⁱⁱ⁾	2% ⁽ⁱⁱⁱ⁾
	S	10% ⁽ⁱ⁾	3% ⁽ⁱⁱ⁾	2%
	G	10% ⁽ⁱ⁾	3% ⁽ⁱⁱ⁾	2%
	B	10% ⁽ⁱ⁾	3% ⁽ⁱⁱ⁾	2%
	O	10% ⁽ⁱ⁾	3% ⁽ⁱⁱ⁾	2%
CO ₂ EF	L	3% ^(iv)	3% ^(iv)	3% ^(iv)
	S	7% ^(v)	7% ^(v)	7% ^(v)
	G	7% ^(v)	7% ^(v)	7% ^(v)
	B	7% ^(v)	7% ^(v)	7% ^(v)
	O	7% ^(v)	7% ^(v)	7% ^(v)
CH ₄ EF	L	100% ^(vi)	100% ^(vi)	100% ^(vi)
	S	100% ^(vi)	100% ^(vi)	100% ^(vi)
	G	100% ^(vi)	100% ^(vi)	100% ^(vi)
	B	100% ^(vi)	100% ^(vi)	100% ^(vi)
	O	100% ^(vi)	100% ^(vi)	100% ^(vi)
N ₂ O EF	L	150% ^(vii)	150% ^(vii)	150% ^(vii)
	S	150% ^(vii)	150% ^(vii)	150% ^(vii)
	G	150% ^(vii)	150% ^(vii)	150% ^(vii)
	B	150% ^(vii)	150% ^(vii)	150% ^(vii)
	O	150% ^(vii)	150% ^(vii)	150% ^(vii)
(i)	Chapter 2: Stationary Combustion of 2006 IPCC Guidelines for National Greenhouse Gas Inventories. Highest value of the range 5-10% of "Extrapolation" in "Less developed statistical systems".			
(ii)	Chapter 2: Stationary Combustion of 2006 IPCC Guidelines for National Greenhouse Gas Inventories. Highest value of the range 2-3% of "Surveys" in "Well developed statistical systems".			
(iii)	Chapter 2: Stationary Combustion of 2006 IPCC Guidelines for National Greenhouse Gas Inventories. Lowest value of the range 2-3% of "Surveys" in "Well developed statistical systems".			
(iv)	Chapter 2: Stationary Combustion of 2006 IPCC Guidelines for National Greenhouse Gas Inventories. Highest value for "Oil" in "Table 2.13".			
(v)	Chapter 2: Stationary Combustion of 2006 IPCC Guidelines for National Greenhouse Gas Inventories. Average value for "Coke, oil, gas" in "Table 2.13".			
(vi)	Highest value of Table 2.14 of "Volume 2: Energy" of "2006 IPCC Guidelines for National Greenhouse Gas Inventories".			
(vii)	Average UK value in "Table 2.14" of "Volume 2: Energy" of "2006 IPCC Guidelines for National Greenhouse Gas Inventories".			

4.2.3.6 Category specific QA/QC and verification

Emissions estimates were based on a bottom-up approach with collection of plant specific lime production data. A comparison was made using a top-down approach based on lime production data obtained from national production statistics (IAPI). We only present data from 2010 onwards given the significant lack of plant specific lime production data from 1990 to 2009. Upon contact, several facilities responded that they did not possess such old data due to company restructuration or human resources allocation. As presented in the figure below, from 2010 onwards there are slight differences using the two approaches but, generally, data is consistent.

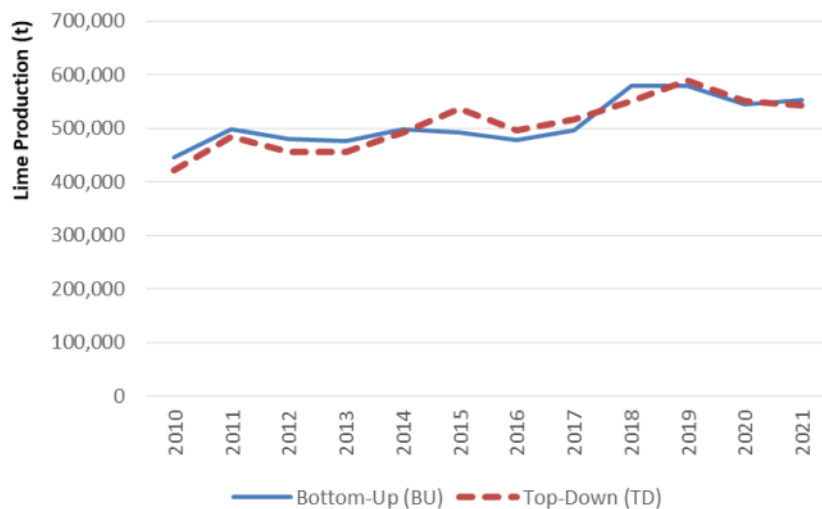

Figure 4-10: Lime production in dedicated plants – comparison of approaches

Following QA/QC procedures to the sector, lime production data series reported in CRF tables from 1990 to 2009 was revised and corrected, due to a compilation error. This correction does not affect CO₂ emissions because these values were already being used, they were just not being correctly reported in the CRF tables.

Further QA/QC procedures to the sector identified a compilation error regarding 2018 and 2019 lime production values for one facility. Again, this correction also does not affect CO₂ emissions because from 2005 onwards, lime production data is not used to estimate CO₂ emissions.

4.2.3.7 Recalculations

No recalculations were made.

4.2.3.8 Further Improvements

In the future, we intend to analyse further the consistency of the entire time series of this category in order to address differences in the IEF in the period 2005-2007. However, for the time being, we considered we have already made progresses towards this issue in the last submissions.

4.2.4 Lime Production in Iron and Steel (CRF 2.A.2)

4.2.4.1 Category description

Besides the production of lime in the lime industry to furnish market requirements, lime is also produced and consumed inside industrial sectors. That is the case of iron and steel production, whereas emissions from this activity are also reported in this source category. There are two iron and steel facilities in Portugal. One of the facilities has always purchased lime from national lime dedicated plants, whose emissions are accounted for in chapter 4.2.3, above. From 1990-2001, only one iron and steel facility produced lime as a non-marketed intermediate product, to consume internally in its kilns. Those emissions are addressed in this chapter. More information is provided in chapter 4.4.2 – Iron and Steel Production (2.C.1).

4.2.4.2 Methodology

Emissions were estimated based on a Tier 1 approach according to chapter 2.3 of the 2006 IPCC Guidelines:

Equation 4-6: CO₂ Emissions from lime production in iron and steel

$$Emi(CO_2) = m(Lime) \times Cont(CaO) \times \frac{m(CO_2)}{m(CaO)} \times 10^{-3}$$

**Where:**

Emi(CO₂): Emissions of CO₂ (kt CO₂)

m(Lime): Lime production in lime kilns (t)

Cont(CaO): CaO content in lime (dimensionless)

m(CO₂)/m(CaO): stoichiometric ratio between CO₂ and CaO in lime kilns (t CO₂/t CaO)

According to the 2006 IPCC Guidelines (Section 2.3.1.1 of Volume 3), in a Tier 1 approach it is not necessary for *good practice* to gather information on country-specific information on lime production by type, nor to account for LKD.

4.2.4.3 Emission Factors

The following parameters were applied in order to estimate CO₂ emissions:

Table 4-7: Emission Factors

Parameter	Unit	EF	Source
CO ₂ /CaO	t CO ₂ /t CaO	0.785	Table 2.4 of Volume 3: Industrial Processes and Product Use of 2006 IPCC Guidelines for National Greenhouse Gas Inventories
CaO content in High-Calcium Lime	t CaO/t Lime	0.950	Table 2.4 of Volume 3: Industrial Processes and Product Use of 2006 IPCC Guidelines for National Greenhouse Gas Inventories

4.2.4.4 Activity Data

Regarding lime production in the integrated iron and steel facility, upon contact, the facility indicated that does not possess information concerning consumption of limestone/dolomite for other purposes than lime production, due to company restructuring in 2001 and consequent loss of old data. During the 2022 UNFCCC review, the ERT also referred that if half of the limestone/dolomite used for lime production were to be used as flux in steel production, it would result in a 0.01% difference in emissions from the use of limestone and dolomite, which is below the significance threshold established in paragraph 37(b) of the UNFCCC Annex I inventory reporting guidelines. Therefore, we will continue to consider that in the period 1990-2001, all limestone/dolomite were used for lime production and that there were no other uses for limestone/dolomite in the iron and steel facility.

Lime production in the iron and steel facility was obtained directly from the facility for the period 1991-1994.

Given there is no available lime production data for 1995-2001, the splicing technique “overlap” (section 5.3.1.1 of the 2006 IPCC Guidelines) was used in order to estimate lime production for the missing years, using as surrogate data total steel production series:

Equation 4-7: Lime production estimated for 1990 and 1995-2001

$$Lime\ Prod_y = Steel\ Prod_y \times \frac{Lime\ Prod_{1991-1994}}{Steel\ Prod_{1991-1994}}$$

Where:

Lime Prod_y: Lime production in year y (t)

Steel Prod_y: Total steel production in year y (t)

Lime Prod₁₉₉₁₋₁₉₉₄: Average lime production in period 1991-1994 (t)

Steel production₁₉₉₁₋₁₉₉₄: Average total steel production in period 1991-1994 (t)



In order to ensure time series consistency between the two data sets, lime production for the period 1995-2001 and 1990 (Lime Prod_y) was based on the ratio between the average steel production in the period 1991-1994 and the average lime production in the period 1991-1994.

Steel production from BOF (Basic Oxygen Furnace) data in the period 1990-2001 was obtained from the facility. The rationale used to choose this dataset was that, as an integrated iron and steel facility, the close relationship between intermediate products and steel produced from BOF is notorious, since their production is intrinsically related to the final amount of steel produced. Therefore, we opted to use steel production as proxy instead of fuel consumption.

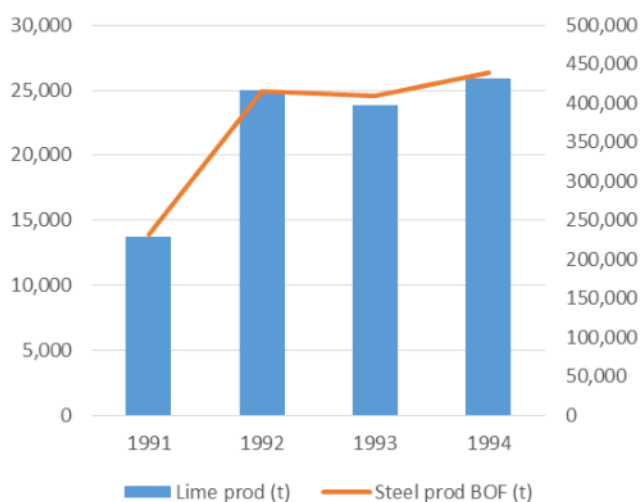

Figure 4-11: Lime production and steel production from BOF in Iron and Steel

For the 1995-2001 and 1990 data overlap, we decided to fix the data used as the average of the period 1991-2004, given it is the only available data.

Lime production data in that iron and steel plant is presented in the figure below.

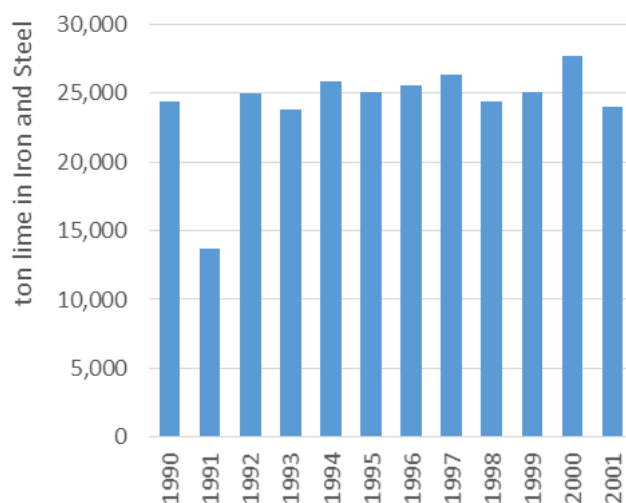

Figure 4-12: Lime production in Iron and Steel

In 2002, the iron and steel facility terminated internal lime production and the lime production line became an independent lime dedicated plant, accounted and reported in chapter 4.2.2.



From 2002 onwards, lime used in iron and steel facilities comes from national lime production, which is accounted for in 2.A.2, chapter 4.2.3 above (Lime production in dedicated plants). Emissions from lime production are estimated based on a Tier 3 approach, where LKD correction is accounted for.

4.2.4.5 Uncertainty Assessment

Table 4-8: Uncertainty values related to emissions reported under CRF 2.A.2 – Iron and Steel

Parameter	Type of Uncertainty	Uncertainty	Source
Activity Data	Lime production data	1.5% (average of 1.0-2.0% range)	Average of the range 1.0-2.0% of Table 2.5 of Chapter 2: Mineral Industry Emissions of 2006 IPCC Guidelines for National Greenhouse Gas Inventories.
CO ₂ EF	CaO in lime	6.0% (average of 4.0-8.0% range)	Average of the range 4.0-8.0% of "Table 2.5" of "Chapter 2: Mineral Industry Emissions" of "2006 IPCC Guidelines for National Greenhouse Gas Inventories".
CO ₂ EF	EF of High Calcium Lime	2.0%	"Emission factor high calcium lime" (2%) of "Table 2.5" of "Chapter 2: Mineral Industry Emissions" of "2006 IPCC Guidelines for National Greenhouse Gas Inventories".
CO ₂ EF	Combined Uncertainty	6.3%	-

4.2.4.6 Category specific QA/QC and verification

QA/QC procedures included a series of checks: calculation, formulas verification, data and parameters verification and the information provided in this report.

4.2.4.7 Recalculations

No recalculations were made.

4.2.4.8 Further Improvements

No further improvements are planned.

4.2.5 Lime Production in Paper Pulp (CRF 2.A.2)

4.2.5.1 Category description

Lime is also produced in Kraft paper pulp plants. In this case, quicklime is produced from carbonates in lime kilns and it is used to regenerate green liquor to white liquor.

4.2.5.2 Methodology

We consider both CaCO₃ used to produce lime in lime kilns and Na₂CO₃ used in causticisers to convert green liquor in white liquor. The CaCO₃ produced in the causticiser from Na₂CO₃ is subsequently transformed in CaO in the lime kilns.

Equation 4-8: Chemical conversion equations

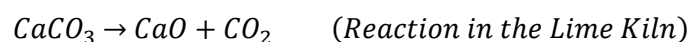

CO₂ emissions are estimated through a mass balance, from the quantification of carbon in CaCO₃ and Na₂CO₃ and the quantities of CO₂ that are liberated in the conversion process. Therefore, emissions are estimated from consumption of carbonate materials, according to the following equation:

Equation 4-9: CO₂ Emissions from carbonates consumption in paper pulp

$$\text{Emi}_{\text{CO}_2} = M_i \times \text{EF}_i \times 10^{-3}$$

**Where:**

Emi_{CO_2} : CO₂ emissions (kt)

M_i : Mass of carbonate i consumed (t)

EF_i : Emission factor of carbonate i consumed (t CO₂/t of carbonate)

According to EU-ETS reporting, in 2019 an amount of CO₂ generated from fossil carbon from one paper pulp facility was captured and combined with sodium hydroxide (NaOH) in order to produce calcium carbonate (CaCO₃). That amount of CO₂ was chemically bound to the carbonate and was not released into the atmosphere, therefore, was discounted from the facility's reported emissions. CO₂ recovered emissions were collected from EU-ETS. However, further analysis and contact with the facility showed that, in fact, these CO₂ recovered emissions are mostly derived from the fuel rather than the carbonate material. Moreover, this CO₂ capture was already made in some years, however, was not reported in the EU-ETS as such. For these reasons, we decided to not include these amounts in category 2.A.2 and assess this issue more thoroughly in the future.

4.2.5.3 Emission Factors*Table 4-9: Emission Factors*

Carbonate	Unit	EF
CaCO ₃	t CO ₂ /t CaCO ₃	0.440
Na ₂ CO ₃	t CO ₂ /t Na ₂ CO ₃	0.415

4.2.5.4 Activity Data

In the period 1990-2004, data on consumption of CaCO₃ (in paper pulp lime kilns) and Na₂CO₃ (in causticisers) was obtained directly from the facilities. From 2005 onwards, these data were obtained from EU-ETS. Time series consistency is guaranteed between the both sets of data, given the report to the EU-ETS is also made by the facilities.

In the estimates of CaO, we only consider additional CaCO₃ that is bought to produce CaO. The amounts of carbonaceous sludge consumed (CaCO₃) are not considered since they correspond to a closed cycle of carbon in the liquors cycle.

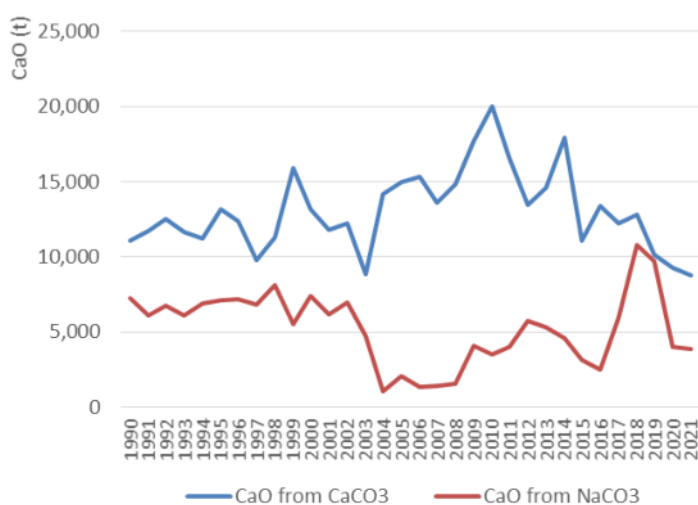
*Figure 4-13: Lime Production in paper pulp*

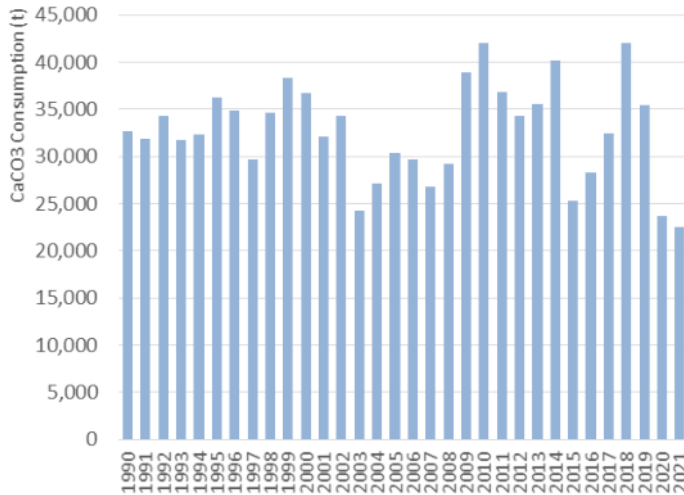

Figure 4-14: CaCO₃ Consumption in paper pulp

4.2.5.5 Uncertainty Assessment

Table 4-10: Uncertainty values related to emissions reported under CRF 2.A.2 – paper pulp

Parameter	Type of Uncertainty	Uncertainty	Source
Activity Data	Lime production data	1.5% (average of 1.0-2.0% range)	Average of the range 1.0-2.0% of Table 2.5 of Chapter 2: Mineral Industry Emissions of 2006 IPCC Guidelines for National Greenhouse Gas Inventories.
CO ₂ EF	CaO in lime	6.0% (average of 4.0-8.0% range)	Average of the range 4.0-8.0% of "Table 2.5" of "Chapter 2: Mineral Industry Emissions" of "2006 IPCC Guidelines for National Greenhouse Gas Inventories".
CO ₂ EF	EF of High Calcium Lime	2.0%	"Emission factor high calcium lime" (2%) of "Table 2.5" of "Chapter 2: Mineral Industry Emissions" of "2006 IPCC Guidelines for National Greenhouse Gas Inventories".
CO ₂ EF	Combined Uncertainty	6.3%	-

4.2.5.6 Category specific QA/QC and verification

QA/QC procedures included a series of checks: calculation formulas verification, data and parameters verification and the information provided in this report.

4.2.5.7 Recalculations

No recalculations were made.

4.2.5.8 Further Improvements

No further improvements are expected.

4.2.6 Lime production in Other Sectors (CRF 2.A.2)

4.2.6.1 Category description

Besides the production of lime in the above mentioned sectors, lime production in sugar mills and artisanal production of lime for sanitation purposes or for whitewash may be also sources of emissions.

Currently, there are 2 operating units in Portugal (RAR and Sidul) that use milk of lime in their carbonatation process. Portugal investigated these potential activities in order to estimate related CO₂ emissions. This milk of lime refers to calcium hydroxide produced outside these units (purchased lime) and consequently do not



result in extra CO₂ emissions, as they are already accounted in lime production dedicated plants (chapter 4.2.3). Therefore, we consider that currently there are no emissions related to these sources.

There was another sugar mill in the past (Sociedade de Desenvolvimento Agro-Industrial/DAI, not operating anymore), which started operating in 1996/97, and produced lime until 2008, according to its Environmental Licence and Environmental Reports. From August 2008 to 2015, lime was purchased and consequently does not result in extra CO₂ emissions, as it is already accounted in lime production dedicated plants (chapter 4.2.3). The facility terminated operations in May 2015.

Following a 2018 ESD review question, we obtained data on lime production from this facility for the period 1997-2008 (when the lime kiln operated) and made conservative CO₂ estimates, which were far below (max. 0.013%) the level of significance. Energy related emissions were not considered as already included in the energy sector.

The artisanal production of lime for sanitation purposes or for whitewash does not exist anymore.

In 1997 there were still 6 or 7 traditional kilns in operation in the south region of the country. They were intermittent ovens (unprofitable). In 2007, only 2 existed, which have since ceased to work. There are no statistics available on this production, as it referred to artisanal and traditional small kilns.

Following further research in order to assess the relevance of the potential underestimation, rough conservative CO₂ estimates were made. Artisanal production of lime was obtained for 1990-2019 from "MARGALHA, Maria Goreti - The use of lime in mortars in Alentejo (in Portuguese). Masters thesis, Évora University, Évora, 1997" and upon contact with some facilities. A Tier 1 CO₂ emission factor was applied according to 2006 IPCC Guidelines, considering high-calcium lime (Table 2.4 of chapter "2 - Mineral Industry Emissions" Volume 3).

These estimates were found to be well below the threshold of significance (below 0.013%), therefore, we consider emissions from artisanal production of lime not relevant/negligible.

4.2.6.2 Methodology

The methodology applied regarding lime production in sugar mills was the same as previous sub-chapter (Lime Production in Paper Pulp Production), i.e. the CO₂ emissions were estimated from the quantification of carbon in CaCO₃, and therefore were estimated from consumption of carbonate materials:

Equation 4-10: CO₂ Emissions from lime production in other sectors

$$Emi_{CO_2} = M_i \times EF_i \times 10^{-3}$$

Where:

Emi_{CO₂}: CO₂emissions (kt)

M_i: mass of carbonate i consumed (t)

EF_i: Emission factor of carbonate i consumed (t CO₂/t of carbonate)

4.2.6.3 Emission Factors

Table 4-11: Emission Factors

Carbonate	Unit	EF
CaCO ₃	t CO ₂ /t CaCO ₃	0.440
Na ₂ CO ₃	t CO ₂ /t Na ₂ CO ₃	0.415



4.2.6.4 Activity Data

At the present, there are two sugar mills operating in Portugal. In their carbonation processes, they use calcium hydroxide produced outside the facilities (purchased lime) and, consequently, do not generate extra CO₂ emissions, as these are already accounted for in lime production dedicated plants (Chapter 4.2.3).

There was another sugar mill (not operating since May 2015), that began operating in 1996/97 and produced lime until 2008. However, from August 2008 to May 2015, lime production was discontinued and lime was purchased during this period. We have estimated conservative CO₂ emissions for the period 1997-2008, when the lime kiln operated, based on data received from the company, that are not presented due to confidentiality constraints.

4.2.6.5 Uncertainty Assessment

Table 4-12: Uncertainty values – other sectors

Parameter	Type of Uncertainty	Uncertainty	Source
Activity Data	Lime production data	1.5% (average of 1.0-2.0% range)	Average of the range 1.0-2.0% of Table 2.5 of Chapter 2: Mineral Industry Emissions of 2006 IPCC Guidelines.
CO ₂ EF	CaO in lime	6.0% (average of 4.0-8.0% range)	Average of the range 4.0-8.0% of Table 2.5 of Chapter 2: Mineral Industry Emissions of 2006 IPCC Guidelines.
CO ₂ EF	EF of High Calcium Lime	2.0%	Emission factor high calcium lime (2%) of Table 2.5 of Chapter 2: Mineral Industry Emissions of 2006 IPCC Guidelines.
CO ₂ EF	Combined Uncertainty	6.3%	-

4.2.6.6 Category specific QA/QC and verification

QA/QC procedures included a series of checks: calculation formulas verification, data and parameters verification and the information provided in this report.

4.2.6.7 Recalculations

No recalculations were made.

4.2.6.8 Further Improvements

No further improvements are planned.



4.2.7 Glass Production (CRF 2.A.3)

4.2.7.1 Category description

Glass is normally made from sand, limestone, soda ash, and possibly recycled broken glass (cullet). It is made submitting these materials to a high temperature which are thereafter made solid without crystallization (semi-solid state).

Glass involves CO₂ emissions from decarbonizing of limestone and carbonate materials under high temperature conditions. Carbonate materials vary with the desired product and comprehend typically limestone, dolomite, soda ash (sodium carbonate) and other carbonate compounds of potassium, barium or strontium.

Combustion emissions from glass production addressed and reported in source sector 1.A.2, estimated from fuel consumption data or production data. Some anthracite coal is used also as additive in glass production. However, because the consumption of this material is already considered in the energy balance, to avoid double counting of emissions from coal use are not considered here⁷

National glass production is essentially made up of the glass segments of packaging, flat glass and domestic glass, differing from the verified in the European Union (EU15) as the production of glass fibers, special glasses and high-tech products for very specific activities (optics, electronics and chemistry).

4.2.7.2 Methodology

For each type of glass except for crystal glass, CO₂ emissions from glass production are Kiln Input based, estimated by the facilities according to No. 11 of Annex IV of Regulation (EU) No. 2066/2018 (<https://eur-lex.europa.eu/legal-content/pt/TXT/?uri=CELEX%3A32018R2066>). Calculation is based on the amount of carbonates in the raw materials consumed (Tier 3), according to the following equation:

Equation 4-11: CO₂ Emissions from glass production

$$\text{Emission}_{\text{CO}_2} = \text{Carbonate}_i \times \text{EF}_{\text{CO}_2(i)} \times F_i$$

Where:

Emission_{CO₂}: CO₂ emissions from consumption of specific carbonate (kt)

Carbonate_i: Mass of carbonate i consumed (t)

EF_{CO₂i}: Emission factor from consumption of carbonate i (t CO₂/t of carbonate)

F_i: fraction calcination achieved for carbonate i (0-1)

Given the fact that there is no calcination factor monitoring in ETS, we assumed complete calcination, therefore, F_i equal to 1 (100%).

There is only one crystal glass plant reporting data under ETS. Thus, in order to estimate national CO₂ emissions related to crystal glass production, the following methodology is applied:

Equation 4-12: CO₂ Emissions from crystal glass production

$$\text{Total}_{\text{CO}_2} = \text{ETS}_{\text{CO}_2} \times \frac{\text{Total}_{\text{prod}}}{\text{ETS}_{\text{prod}}}$$

⁷ They were not used to derive the country specific emission factors for instance.

**Where:**

Total_{CO2}: CO₂ emissions related to national total crystal glass production (t)

ETS_{CO2i}: CO₂ emissions obtained from the only crystal glass plant that reports data under ETS (t)

Total_{prod}: National total crystal glass production (t)

ETS_{prod}: Crystal glass production of the only crystal glass plant that reports data under ETS (t)

4.2.7.3 Emission Factors

The following emission factors from Annex IX of Directive 2003/87/EC were considered:

Table 4-13: Emission Factors

Raw material	EF	Unit EF
CaCO ₃	0.440	t CO ₂ /t carbonate
MgCO ₃	0.477-0.523	t CO ₂ /t carbonate
Na ₂ CO ₃	0.415	t CO ₂ /t carbonate
BaCO ₃	0.223	t CO ₂ /t carbonate
Li ₂ CO ₃	0.596	t CO ₂ /t carbonate
K ₂ CO ₃	0.318	t CO ₂ /t carbonate
NaHCO ₃	0.524	t CO ₂ /t carbonate
XY(CO ₃)Z	var	t CO ₂ /t carbonate
Ca(OH) ₂	0.098-0.114	t CO ₂ /t

4.2.7.4 Activity Data

We don't use data from INE because not all products are reported in weight, but instead are measured in area-units (m²) or number of produced pieces.

Data on container glass production was obtained from AIVCERV/CTCV (Container Glass National Association). Flat Glass production data was obtained from the only industrial unit in Portugal. In 1996 there was no flat glass production due to an interruption in the production lines. From 2009 onwards, there is no Flat Glass production in Portugal. Crystal Glass production data was obtained from AIC (Crystal Glass National Association).

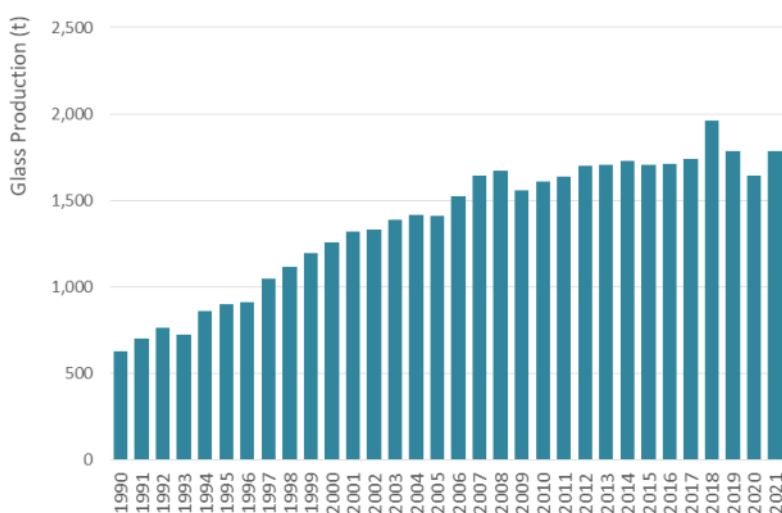

Figure 4-15: Glass production

Due to confidentiality constraints concerning flat glass data (there was only one facility in Portugal until 2009), we don't present glass production data by glass type.



From 2005 onwards Na_2CO_3 , MgCO_3 , CaCO_3 , BaCO_3 , coal and other carbonate raw materials consumption in the kilns are collected from EU-ETS.

Given there is no available carbonates consumption data for 1990-2004, the splicing technique “overlap” (section 5.3.1.1 of the 2006 IPCC Guidelines) was used in order to estimate carbonates consumption for the missing years, using glass production as surrogate data:

Equation 4-13: Carbonate consumption – 1990-2004

$$\text{Carbonate}_y = \text{Glass Prod}_y \times \frac{\text{Carbonate}_{2005-2009}}{\text{Glass Prod}_{2005-2009}}$$

Where:

Carbonate_y : Carbonate consumption in year y (t)

$\text{Glass Production}_y$: Glass production in year y (t)

$\text{Carbonate}_{2005-2009}$: Average carbonate consumption in period 2005-2009 (t)

$\text{Glass Production}_{2005-2009}$: Average glass production in period 2005-2009 (t)

In order to ensure time series consistency between the two data sets, carbonate consumption for the period 1990-2004 (Carbonate_y) was based on the ratio between the average carbonate consumption in the period 2005-2009 and the average glass production in the period 2005-2009.

In the period 1990-2004, glass production data by type of glass (flat, container, crystal) was obtained from national glass associations, since there is no detailed data on carbonate raw material consumption from ETS in that period.

For the 1990-2004 data overlap, we decided to fix the data used as the average of the period 2005-2009, in order to avoid yearly corrections associated to the introduction of last year ratios and given it is the closest period with available and reliable data.

For flat glass and container glass, the facilities that report data under ETS correspond to the national total. Flat glass production terminated in 2009.

For crystal glass it is used the ETS data from the largest facility that reports data under ETS and data is extrapolated for the remaining crystal glass facilities based on crystal glass production.

According to EU-ETS, since 2019 a facility is testing the incorporation of a new raw material $\text{Ca}(\text{OH})_2$ (hydrated lime) in its container glass production process. According to the facility, this raw material aims to improve the quality of glass and reduce energy consumption and CO_2 emissions.

Raw materials consumption is presented in the figure below.

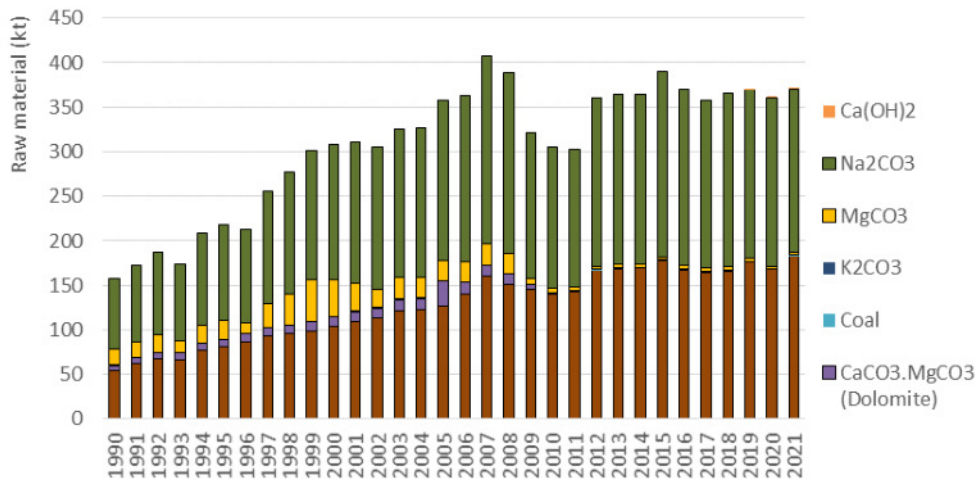

Figure 4-16: Raw materials consumption

Cullet incorporation is not directly included in the estimates. However, the increase of cullet incorporation leads to a decrease in other raw materials consumption, as could be observed in years 2010 and 2011. Cullet incorporation ratio by type of glass can be checked in the figure below.

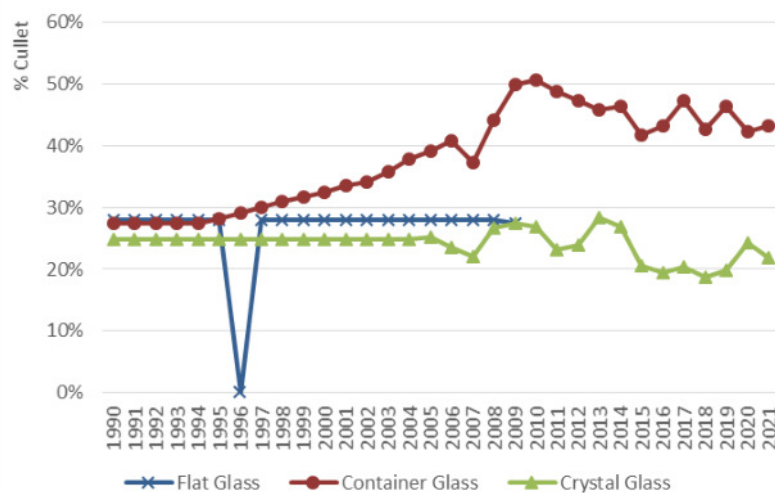

Figure 4-17: Cullet incorporation by type of glass

4.2.7.5 Uncertainty Assessment

Table 4-14: Uncertainty values related to emissions reported under CRF 2.A.3 – Glass Production

Parameter	Type of Uncertainty	Uncertainty	Source
Activity Data	Weighing or proportioning materials	2.0% (average of 1.0-3.0% range)	Subchapter 2.4.2.2 of chapter 2: Mineral Industry Emissions of 2006 IPCC Guidelines.
Activity Data	Glass Production	5.0%	Subchapter 2.4.2.2 of chapter 2: Mineral Industry Emissions of 2006 IPCC Guidelines.
Activity Data	Combined Uncertainty	5.4%	-
CO2 EF	Stoichiometric ratio	2.0% (average of 1.0-3.0% range)	Subchapter 2.4.2.1 of chapter 2: Mineral Industry Emissions of 2006 IPCC Guidelines
CO2 EF	Calcination of the carbon input	1.0%	Subchapter 2.4.2.1 of chapter 2: Mineral Industry Emissions of 2006 IPCC Guidelines.
CO2 EF	Combined Uncertainty	2.2%	-



Table 4-15: Uncertainty values related to emissions reported under CRF 1.A.2.f

Parameter	Fuel Type	1990-2004	2005-2007	2008 onwards
Activity Data	L	10% ⁽ⁱ⁾	3% ⁽ⁱⁱ⁾	2% ⁽ⁱⁱⁱ⁾
	S	10% ⁽ⁱ⁾	3% ⁽ⁱⁱ⁾	2%
	G	10% ⁽ⁱ⁾	3% ⁽ⁱⁱ⁾	2%
	B	10% ⁽ⁱ⁾	3% ⁽ⁱⁱ⁾	2%
	O	10% ⁽ⁱ⁾	3% ⁽ⁱⁱ⁾	2%
CO ₂ EF	L	3% ^(iv)	3% ^(iv)	3% ^(iv)
	S	7% ^(v)	7% ^(v)	7% ^(v)
	G	7% ^(v)	7% ^(v)	7% ^(v)
	B	7% ^(v)	7% ^(v)	7% ^(v)
	O	7% ^(v)	7% ^(v)	7% ^(v)
CH ₄ EF	L	100% ^(vi)	100% ^(vi)	100% ^(vi)
	S	100% ^(vi)	100% ^(vi)	100% ^(vi)
	G	100% ^(vi)	100% ^(vi)	100% ^(vi)
	B	100% ^(vi)	100% ^(vi)	100% ^(vi)
	O	100% ^(vi)	100% ^(vi)	100% ^(vi)
N ₂ O EF	L	150% ^(vii)	150% ^(vii)	150% ^(vii)
	S	150% ^(vii)	150% ^(vii)	150% ^(vii)
	G	150% ^(vii)	150% ^(vii)	150% ^(vii)
	B	150% ^(vii)	150% ^(vii)	150% ^(vii)
	O	150% ^(vii)	150% ^(vii)	150% ^(vii)
(viii)	Chapter 2: Stationary Combustion of 2006 IPCC Guidelines for National Greenhouse Gas Inventories. Highest value of the range 5-10% of "Extrapolation" in "Less developed statistical systems".			
(ix)	Chapter 2: Stationary Combustion of 2006 IPCC Guidelines for National Greenhouse Gas Inventories. Highest value of the range 2-3% of "Surveys" in "Well developed statistical systems".			
(x)	Chapter 2: Stationary Combustion of 2006 IPCC Guidelines for National Greenhouse Gas Inventories. Lowest value of the range 2-3% of "Surveys" in "Well developed statistical systems".			
(xi)	Chapter 2: Stationary Combustion of 2006 IPCC Guidelines for National Greenhouse Gas Inventories. Highest value for "Oil" in "Table 2.13".			
(xii)	Chapter 2: Stationary Combustion of 2006 IPCC Guidelines for National Greenhouse Gas Inventories. Average value for "Coke, oil, gas" in "Table 2.13".			
(xiii)	Highest value of Table 2.14 of "Volume 2: Energy" of "2006 IPCC Guidelines for National Greenhouse Gas Inventories".			
(xiv)	Average UK value in "Table 2.14" of "Volume 2: Energy" of "2006 IPCC Guidelines for National Greenhouse Gas Inventories".			

4.2.7.6 Category specific QA/QC and verification

QA/QC procedures included a series of checks: calculation formulas verification, data and parameters verification and the information provided in this report.

Following QA/QC activities to the sector, some allocation errors regarding carbonates consumption time series were identified and corrected for the period 1990-2018.

4.2.7.7 Recalculations

The correction of the allocation errors above mentioned resulted in variations between -0.2 and 0.3% in CO₂ emissions for the period 1990-2018.

4.2.7.8 Further Improvements

No further improvements are planned.



4.2.8 Glass Wool Production (CRF 2.A.3)

4.2.8.1 Category description

Glass wool is a category of mineral wool, where the production process is similar to glass making, already addressed in the previous chapter.

Glass wool production began being reported in the EU-ETS in 2019, as one facility entered in operation. Glass wool from this facility is produced from sand, sodium carbonate and recycled broken glass (cullet), submitting these materials to a high temperature, causing them to melt and then spun into fibres and mixed with organic resin before curing into products.

Glass wool production generates CO₂ emissions from decarbonizing of carbonate materials under high temperature conditions. There are, also, indirect CO₂ emissions related to NMVOC. The methodology used to estimate NMVOC emissions could be checked in the Portuguese IIR. Indirect CO₂ emissions related to NMVOC emissions from glass wool production are reported in CRF Table 6.

Combustion emissions from glass wool production are reported in source sector 1.A.2, estimated from fuel consumption data.

4.2.8.2 Methodology

CO₂ emissions from glass wool production are reported in EU-ETS, estimated by the facilities according to No. 11 of Annex IV of Regulation (EU) No. 2066/2018 (<https://eur-lex.europa.eu/legal-content/pt/TXT/?uri=CELEX%3A32018R2066>). Estimates are Kiln Input based on the amount of carbonates in the raw materials consumed (Tier 3), according to the following equation:

Equation 4-14: CO₂ Emissions from glass production

$$\text{Emission}_{\text{CO}_2} = \text{Carbonate} \times \text{EF}_{\text{CO}_2} \times \text{FC}$$

Where:

Emission_{CO₂}: CO₂ emissions from consumption of sodium carbonate (kt)

Carbonate: Mass of sodium carbonate consumed (t)

EF_{CO₂}: Emission factor from consumption of sodium carbonate (t CO₂/t of carbonate)

FC: fraction calcination achieved for sodium carbonate (0-1)

Given the fact that there is no calcination factor monitoring in ETS, we assumed complete calcination, therefore, FC equals 1 (100%).

4.2.8.3 Emission Factors

The following emission factor was considered:

Table 4-16: Emission Factors

Carbonate	EF	Unit EF
Na ₂ CO ₃	0.415	t CO ₂ /t carbonate

4.2.8.4 Activity Data

Glass wool production began being reported in the EU-ETS in 2019, as one facility entered in operation that year. Carbonate consumption data for year 2019 was obtained from EU-ETS.



Due to confidentiality constraints (there is only one facility in Portugal), we don't present carbonates consumption.

Therefore, we have two different sets of activity data (raw materials and glass wool production) for the same period, but can only report one series in the CRF tables. In order to ensure time series consistency of the activity data reported in the CRF tables, given that glass production (from chapter 4.2.7) is also reported in CRF 2.A.3, we decided to report glass wool production as activity data in CRF tables.

4.2.8.5 Uncertainty Assessment

Table 4-17: Uncertainty values related to emissions reported under CRF 2.A.3 – Glass Wool Production

Parameter	Type of Uncertainty	Uncertainty	Source
Activity Data	Weighing or proportioning raw materials	2.0% (average of 1.0-3.0% range)	Subchapter 2.4.2.2 of chapter 2: Mineral Industry Emissions of 2006 IPCC Guidelines for National Greenhouse Gas Inventories.
Activity Data	Glass Wool Production	5.0%	Subchapter 2.4.2.2 of chapter 2: Mineral Industry Emissions of 2006 IPCC Guidelines for National Greenhouse Gas Inventories.
Activity Data	Combined Uncertainty	5.4%	-
CO2 EF	Stoichiometric ratio	2.0% (average of 1.0-3.0% range)	Subchapter 2.4.2.1 of chapter 2: Mineral Industry Emissions of 2006 IPCC Guidelines for National Greenhouse Gas Inventories.
CO2 EF	Calcination of the carbon input	1.0%	Subchapter 2.4.2.1 of chapter 2: Mineral Industry Emissions of 2006 IPCC Guidelines for National Greenhouse Gas Inventories.
CO2 EF	Combined Uncertainty	2.2%	-

4.2.8.6 Category specific QA/QC and verification

QA/QC procedures included a series of checks: calculation formulas verification, data and parameters verification and the information provided in this report.

4.2.8.7 Recalculations

No recalculations were made.

4.2.8.8 Further Improvements

No further improvements are planned.

4.2.9 Other Process Uses of Carbonates - Ceramics (CRF 2.A.4.a)

4.2.9.1 Category description

Process-related emissions from ceramics result from the calcination of carbonates in the clay, as well as the additions to the kiln.

In Portugal, part of the ceramics sector is included in the EU-ETS from 2013 onwards. However, we only consider that there is a robust characterization of raw materials consumption in the ceramic plants under ETS from 2015 onwards.

4.2.9.2 Methodology

CO₂ emissions from ceramics reported in EU-ETS are estimated by the facilities according to No. 12 of Annex IV of Regulation (EU) No. 2066/2018 (<https://eur-lex.europa.eu/legal-content/pt/TXT/?uri=CELEX%3A32018R2066>). Estimates are Kiln Input based on the amount of carbonates in the raw materials consumed (Tier 3).



Firstly, and given that only part of the ceramics sector is included in the EU-ETS, we work with the Energy Balance in order to obtain total fuel consumption for the ceramics sector and then infer total raw material consumption. From 2015 onwards, national carbonate consumption in ceramics is estimated according to:

Equation 4-15: Annual national carbonate consumption in ceramics – 2015-onwards

$$Total\ Mat_{Carb(m)} = EU - ETS\ Mat_{Carb(m)} \times \frac{EB\ Fuel\ Cons_{(Ceramics)}}{EU - ETS\ Fuel\ Cons_{(Ceramics)}}$$

Where:

Total $Mat_{Carb(m)}$: Total Raw material m consumption for ceramics sector, EU-ETS and non-EU-ETS plants (t)

EU-ETS $Mat_{Carb(m,y)}$: Raw material m consumption for ceramic plants under EU-ETS (t)

EB Fuel Cons_(Ceramics): Total fuel consumption for ceramics sector (obtained from the Energy Balance), EU-ETS and non-ETS plants (GJ)

EU-ETS Fuel Cons_(Ceramics): Fuel consumption for Ceramic plants under ETS (GJ)

From 2015 onwards, CO₂ emissions are estimated through a mass balance between the quantification of carbon in original raw materials and CO₂ emissions generated in the conversion process, according to the following equation:

Equation 4-16: Annual national CO₂ emissions from ceramics – 2015-onwards

$$Emi_{CO_2} = \sum [Mat_{Carb(m)} \times EF_{(m)}] \times 10^{-3}$$

Where:

Emi_{CO₂}: Total annual CO₂ emissions for ceramics sector (kt CO₂)

Mat_{Carb(m)}: Annual consumption of carbonate containing material m (t)

EF_(m): Emission factor of material m consumed (t CO₂/t material m)

Given there is a lack in ceramics characterization in the period 1990-2014, the splicing technique “overlap” (section 5.3.1.1 of the 2006 IPCC Guidelines) was used in order to estimate EU-ETS carbonates consumption for ceramics production, according to the following equation:

Equation 4-17: EU-ETS carbonates consumption - 1990-2014

$$EU - ETS\ Mat_{Carb(m,y)} = EB\ Fuel\ Cons_{(Ceramics,y)} \times \frac{EU - ETS\ Mat_{Carb(m,2015-2018)}}{EB\ Fuel\ Cons_{(Ceramics,2015-2018)}}$$

Where:

EU-ETS $Mat_{Carb(m,y)}$: Raw material m consumption in year y for ceramic plants under EU-ETS (t)

EB Fuel Cons_(Ceramics,y): Energy Balance Ceramics fuel consumption in year y, EU-ETS and non-ETS plants (GJ)

EU-ETS $Mat_{Carb(m, 2015-2018)}$: Average raw material m consumption in the period 2015-2018 for ceramic plants under ETS (t)

EB Fuel Cons_(Ceramics,2015-2018): Average Energy Balance Ceramics fuel consumption in the period 2015-2018, ETS and non-ETS plants (GJ)

In the period 1990 to 2014, the splicing technique “overlap” (section 5.3.1.1 of the 2006 IPCC Guidelines) was used in order to estimate national carbonates consumption for ceramics production, according to the following equation:

**Equation 4-18: Annual national carbonate consumption – 1990-2014**

$$Total\ Mat_{Carb(m,y)} = EB\ Fuel\ Cons_{(Ceramics,y)} \times \frac{EU - ETS\ Mat_{Carb(m,2015-2018)}}{EU - ETS\ Fuel\ Cons_{(Ceramics,2015-2018)}}$$

Where:

Total $Mat_{Carb(m,y)}$: Raw material m consumption in year y for all national ceramics, both ETS and non-ETS plants (t)

EB Fuel Cons_(Ceramics,y): Energy Balance Ceramics fuel consumption in year y, EU-ETS and non-ETS plants (GJ)

EU-ETS $Mat_{Carb(m,2015-2018)}$: Average raw material m consumption in 2015-2018 for ceramic plants under EU-ETS (t)

EU-ETS Fuel Cons_(Ceramics,2015-2018): Average Energy Balance Ceramics fuel consumption in the period 2015-2018, for EU-ETS Ceramic plants (GJ)

Finally, CO₂ emissions for the period 1990-2014 are estimated according to:

Equation 4-19: Annual national CO₂ emissions from ceramics - 1990-2014

$$Emi_{CO_2(y)} = Mat_{Carb(m,y)} \times EF_{(m)} \times 10^{-3}$$

Where:

Emi_{CO₂(y)}: Emission of CO₂ in year y (kt CO₂)

Mat_{Carb(m,y)}: Consumption of carbonate containing material m in year y (t)

EF_(m): Emission factor of material m consumed in year y (t CO₂/t material m)

4.2.9.3 Emission Factors

The emission factors applied are listed in the following table.

From 2015 onwards, in order to ensure time series consistency, emission factors are obtained from EU-ETS data. From 1990 to 2014, information was backcasted based on the average values of raw material consumption and CO₂ emissions from EU-ETS data from 2015 to 2018.

Table 4-18: Emission Factors of raw materials

Raw material	Unit	Emission Factors			
		1990-2014 (1)	2019 (2)	2020 (2)	2021 (2)
Clay	t CO ₂ /t Clay	0.0227	0.0163	0.0156	0.0168
BaCO ₃	t CO ₂ /t BaCO ₃	0.2230	0.2231	0.2230	0.2230
CaCO ₃	t CO ₂ /t CaCO ₃	0.4399	0.4400	0.4400	0.4401
Kaolin	t CO ₂ /t Kaolin	0.0104	0.0092	0.0153	0.0145
Dolomite	t CO ₂ /t Dolomite	0.4709	0.4658	0.4677	0.4700
MgCO ₃	t CO ₂ /t MgCO ₃	0.5220	0.5218	0.5220	0.5220
Na ₂ CO ₃	t CO ₂ /t Na ₂ CO ₃	0.4150	0.4146	0.4143	0.4150
Other Carbonates	t CO ₂ /t Other Carbonates	0.0384	0.0601	0.0577	0.0635
Ceramic Paste	t CO ₂ /t Ceramic Paste	0.0099	0.0070	0.0076	0.0078
Polystyrene	t CO ₂ /t Polystyrene	3.3850	3.3850	3.3799	3.3850

(1) Backcasted using average value from 2015 to 2018
(2) Source: EU-ETS from 2015 onwards



4.2.9.5 Activity Data

Despite there are data available in the EU-ETS on raw materials in ceramics since 2013, we only consider this data to be reliable from 2015 onwards.

From 2015 onwards, both raw materials consumption and respective emission factors have been obtained from ETS data. Since not all ceramics are covered under ETS, raw materials total national consumption have been extrapolated based on energy consumption in ceramics reported both under ETS (just ETS plants) and in the Energy Balance provided by DGEG (total national - both ETS and non-ETS plants), as described in the methodology section above.

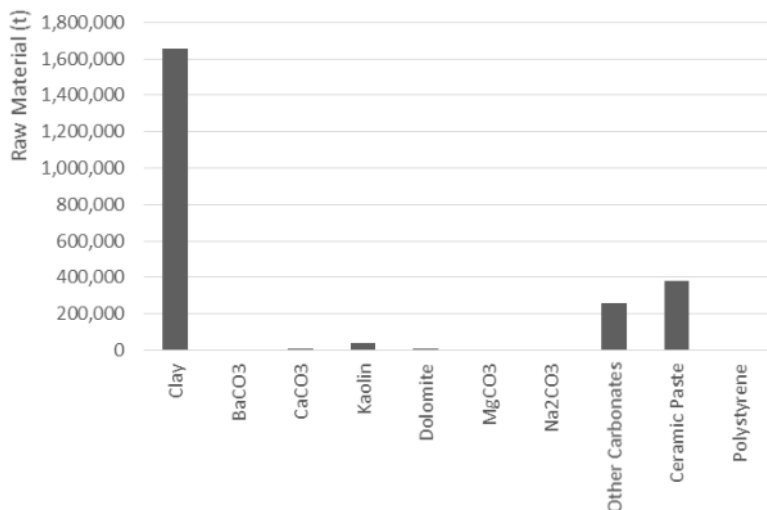

Figure 4-18: Raw materials consumption in EU-ETS plants in 2021

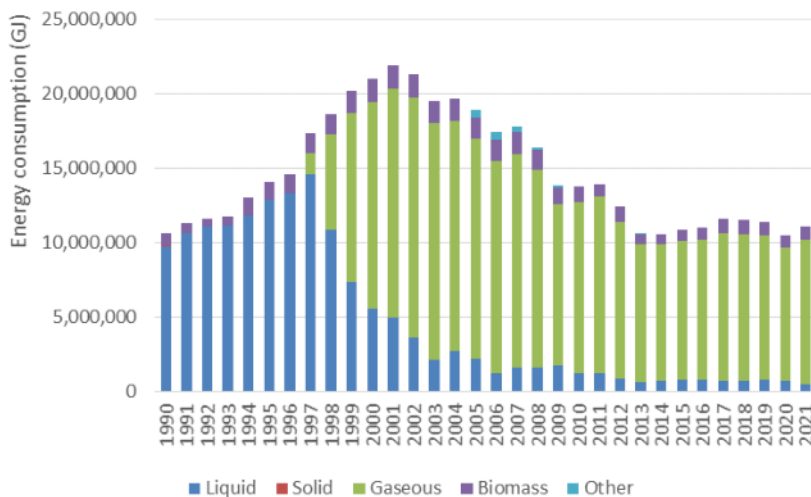

Figure 4-19: Energy consumption in ceramics sector by fuel type (Source: Energy Balance)

In order to estimate the representativeness of the ceramics sector in the EU-ETS we consider Total National Energy Consumption in Ceramics sector from the Energy Balance, obtained from DGEG, and Energy consumption from the ceramic facilities included in EU-ETS and estimate the percentage of ceramic facilities included in EU-ETS.

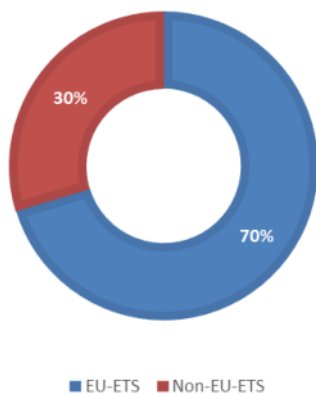

Figure 4-20: % Energy consumption in ceramics sector in 2021

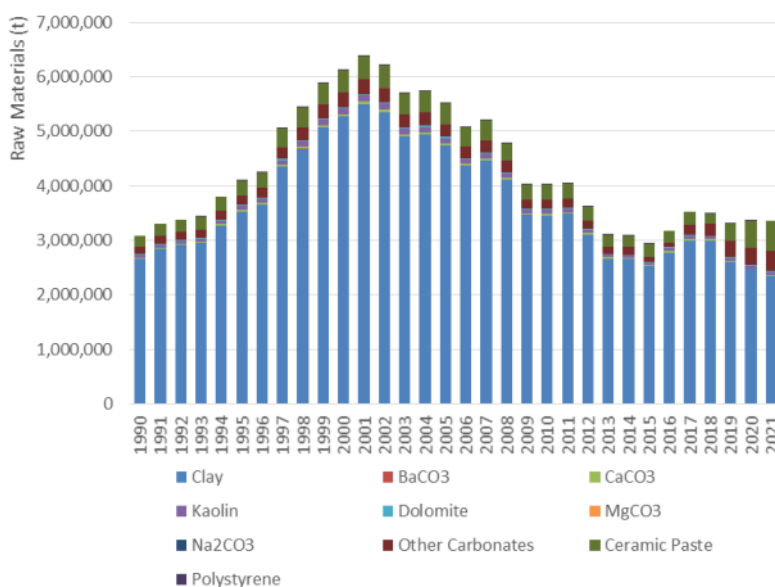

Figure 4-21: Raw materials consumption in ceramics sector

4.2.9.6 Uncertainty Assessment

Table 4-19: Uncertainty values

Parameter	Type of Uncertainty	Uncertainty	Source
Activity Data	Weighing or proportioning raw materials	2.0% (average of 1.0-3.0% range)	Table 2.3 of "Chapter 2: Mineral Industry Emissions" of "2006 IPCC Guidelines for National Greenhouse Gas Inventories"
Activity Data	Carbon content	2.0%	Table 2.3 of "Chapter 2: Mineral Industry Emissions" of "2006 IPCC Guidelines for National Greenhouse Gas Inventories"
Activity Data	Combined Uncertainty	2.8%	-
CO ₂ EF	Fractional purity	3.0% (average of 1.0-5.0% range)	Average value of the range 1-5% of chapter 2.5.2.1 of Volume 3: Industrial Processes and Product Uses of 2006 IPCC Guidelines for National Greenhouse Gas Inventories.

4.2.9.7 Category specific QA/QC and verification

QA/QC procedures included a series of checks: calculation formulas verification, data and parameters verification and the information provided in this report.

Following, QA/QC procedures to the sector, some allocation errors regarding carbonates consumption time series were identified and corrected for the whole time series.



4.2.9.8 Recalculations

The correction of the allocation errors above mentioned resulted in a slight decrease in CO₂ emissions between -2.7 and -0.8% for the period 1990-2020.

4.2.9.9 Further Improvements

Further improvements include pursuing contacts with national ceramics associations in order to gather reliable data on ceramics production for the whole time series and improve information transparency and time series consistency.

4.2.10 Other Process Uses of Carbonates-Other Uses of Soda Ash (CRF 2.A.4.b)

4.2.10.1 Category description

Soda Ash (Na₂CO₃) is consumed as a raw material in the Glass and Glass Wool Production (CRF 2.A.3), in Paper Pulp production (CRF 2.H.1), Ceramics production (CRF 2.A.4.a). Soda ash consumptions from these identified sectors are available in EU-ETS and its emissions are reported in the respective end-use sectors.

Available information from National Statistics indicates that there are other uses for soda ash in Portugal besides the ones above mentioned. These other uses of soda ash include soap and detergents, food and beverages and water treatment. However, Portugal's EU-ETS does not include data from such activities and the inventory team is still not able to quantify and report them in the respective categories. Therefore, for the time being, apparent consumption of soda ash from all other unidentified activities is accounted in category 2.A.4.b. The inventory team considers that the use of soda ash in these sectors may not generate CO₂ emissions, however, is unable to confirm such situation.

Due to confidentiality constraints, emissions from this sector are reported in CRF 2.A.4.d along with "Other Process Uses of Carbonates", hence the notation key IE (Included Elsewhere) in CRF tables.

4.2.10.2 Methodology

In a first step, we estimate soda ash apparent consumption, based on national production, imports and exports data:

Equation 4-20: Soda ash apparent consumption

$$\text{Apparent Consumption} = \text{National Production} + \text{Imports} - \text{Exports}$$

Where:

Apparent Consumption: Total soda ash apparent consumption (t Na₂CO₃)

National Production: Soda ash national production (t Na₂CO₃)

Imports: Total soda ash imports (t Na₂CO₃)

Exports: Total soda ash exports (t Na₂CO₃)



In a second step, we estimate the soda ash apparent consumption in identified sectors for which EU-ETS collects data, such as Paper Pulp, Ceramics, Glass and Glass Wool Production. We subtract these values to national total apparent consumption and ultimately obtain the apparent consumption for the remaining sectors (not addressed under EU-ETS), according to the following equation:

Equation 4-21: Soda ash apparent consumption in other sectors

Apparent Consumption (other sectors) = AC (total) – AC (Glass/Glass Wool) – AC (Paper Pulp) – AC (Ceramics)

Where:

Apparent Consumption (other sectors): Soda ash apparent consumption in sectors other than Glass Production or Paper Pulp Production (t Na₂CO₃)

AC (Total): Soda ash national total apparent consumption (t Na₂CO₃)

AC (Glass): Soda ash consumption in Glass Production (t Na₂CO₃)

AC (Paper and Pulp): Soda ash consumption in Paper and Pulp Production (t Na₂CO₃)

AC (Ceramics): Soda ash consumption in Ceramics (t Na₂CO₃)

Finally, CO₂ emissions related to other unidentified uses of soda ash are estimated based on a Tier 1 approach according to chapter 3.8 of the 2006 IPCC Guidelines:

Equation 4-22: CO₂ Emissions from soda ash consumption (other sectors)

$$\text{Emi (CO}_2\text{)} = \text{AD} \times \text{EF (CO}_2\text{)} \times 10^{-3}$$

Where:

Emi (CO₂): Emissions of CO₂ (kt CO₂)

AD: Soda ash apparent consumption (other sectors) (t)

EF CO₂: CO₂ emissions factor (t CO₂/t soda ash consumed)

4.2.10.3 Emission Factors

Emission factor of soda ash was set from molecular stoichiometry:

Table 4-20: Emission factors of soda ash

Material	EF	Unit
Na ₂ CO ₃ (Soda Ash)	0.415	t CO ₂ /t soda ash

4.2.10.4 Activity Data

According to available information from EU-ETS, soda ash is used in the following end-use sectors: Glass Production, Glass Wool Production, Paper Pulp Production and Ceramics. Soda ash consumptions from these identified sectors were obtained from EU-ETS.

Available information from National Statistics indicates that there are other uses for soda ash in Portugal besides the ones above mentioned, however, these uses are not quantified. Following the 2022 UNFCCC Review, upon contact to our Focal Points as well as National Statistics 'Office, we learned that other uses of soda ash in Portugal include pH correction in water treatment plants (supply water), as a biogas purifier in urban wastewater treatment and soaps and detergents industry. However, Portugal's EU-ETS does not include data from such activities and the inventory team is still not able to identify them and report in the respective categories.



Therefore, for the time being, apparent consumption of soda ash from all other unidentified activities is estimated based on National Production, Imports and Exports. Soda Ash imports and exports data were obtained from INE for the whole time series.

Soda ash production data was obtained from the only soda ash producing facility in Portugal, which operated from 1990 to 2014. Since 2015, there is no soda ash production in Portugal.

Due to confidentiality constraints, activity data for the entire time series is presented as an index value related to 1990 data.

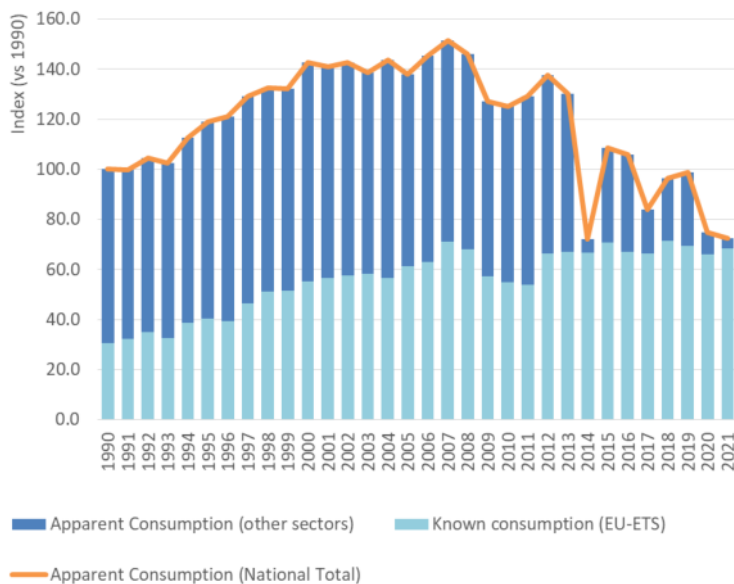

Figure 4-22: Soda ash apparent consumption

4.2.10.5 Uncertainty Assessment

Table 4-21: Uncertainty values

Parameter	Type of Uncertainty	Uncertainty	Source
Activity Data	Weighing or proportioning raw materials	2.0% (average of 1.0-3.0% range)	Table 2.3 of "Chapter 2: Mineral Industry Emissions" of "2006 IPCC Guidelines for National Greenhouse Gas Inventories"
Activity Data	Carbon content	2.0%	Table 2.3 of "Chapter 2: Mineral Industry Emissions" of "2006 IPCC Guidelines for National Greenhouse Gas Inventories"
Activity Data	Combined Uncertainty	2.8%	-
CO2 EF	Fractional purity	3.0% (average of 1.0-5.0% range)	Average value of the range 1-5% of chapter 2.5.2.1 of Volume 3: Industrial Processes and Product Uses of 2006 IPCC Guidelines for National Greenhouse Gas Inventories.

4.2.10.6 Category specific QA/QC and verification

QA/QC procedures included a series of checks: calculation formulas verification, data and parameters verification and the information provided in this report.

Following QA/QC procedures to the sector, as well as a 2022 UNFCCC Review recommendation, given that soda ash is also consumed as a raw material in the ceramics sector, this category was included in the estimates from 1990 onwards.



4.2.10.7 Recalculations

Following QA/QC procedures to the sector, we included soda ash consumption in the ceramics industry from 1990 onwards. Also, imports data were revised from 2010 onwards and exports data were updated from 2013 onwards. Recalculations in CO₂ emissions for this category occurred due to the update of the activity data and are presented in the table and figures below.

No emission factor was updated.

Table 4-22: Recalculations in CO₂ emissions for Other uses of soda ash

Year	Previous submission	Latest submission	Difference	Difference
	kton	kton	kton	%
1990	99.8	86.7	-13.1	-13.2
2000	130.4	109.1	-21.2	-16.3
2010	99.4	87.7	-11.7	-11.8
2018	71.4	31.2	-40.1	-56.2
2019	78.5	36.9	-41.6	-53.0
2020	70.2	11.2	-58.9	-84.0



Figure 4-23: Recalculations in Other uses of soda ash

4.2.10.8 Further Improvements

In the course of the 2022 UNFCCC Review recommendation, we investigated other Portuguese end-use sectors where soda ash is used, by contacting National Statistics as well as our Focal Points on IPPU. We learned that soda ash was used in water treatment plants (supply water) for pH correction.

Also, we learned that soda ash was used in the soaps and detergents industry, as well as in urban wastewater treatment as a biogas purifier, although in not very expressive amounts.

However, Portugal's EU-ETS does not include data from such activities and the inventory team is still not able to identify them and report in the respective categories. Furthermore, we believe that these other uses of soda ash do not result in CO₂ emissions, but cannot confirm such fact.



4.2.11 Other Process Uses of Carbonates-Non Metallurgical Magnesia Production (CRF 2.A.4.c)

There is no non-metallurgical magnesium production in Portugal.

4.2.12 Other Process Uses of Carbonates – Other (CRF 2.A.4.d)

4.2.12.1 Category description

CO₂ liberation to atmosphere occurs from several industrial activities that use limestone (CaCO₃), dolomite rock (CaCO₃.MgCO₃) or other carbonates, but only when original materials are not incorporated as inert components but suffer a chemical removal of carbon, as for example when calcium carbonate is added to nitric acid to form calcium nitrate:

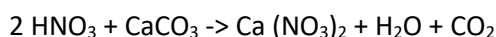

Currently, this category considers Carbonates uses in Fertilizers production and Desulfurization in Large Point Source Energy Plants in Mainland Portugal.

Concerning CRF Tables reporting, this category also reports Other uses of soda ash (not reported in CRF 2.A.4.b due to confidentiality constraints) and Rock wool production (not reported in CRF 2.A.5 given CRF tables do not include such category).

Carbonate materials consumption in glass industry is covered in category 2.A.3 – chapter 4.2.7.

While consumption of carbonate materials is reported in the National Statistics Database (INE) for other industrial activities, some do not correspond to uses where carbon is liberated and no emissions are estimated: paint, soap, pharmaceutical and agrochemical products, cleaning products, perfumeries and hygiene products, glues and adhesives, tire and rubber products, plastic products and synthetic fibres, and all food and beverage industry.

Lime production involves consumption and decarbonizing of carbonate materials as well, limestone or dolomite rock. There are dedicated lime production facilities and there is also lime production in lime kilns in paper pulp industry and in iron and steel industry. CO₂ emissions from lime production are reported in category 2.A.2 – chapters 4.2.3, 4.2.4 and 4.2.5.

Regarding Desulfurization in Large Point Source Energy Plants in Mainland Portugal, from the information gathered, only two plants in Portugal implement this kind of abatement system: Pêgo and Sines. Both plants use hard coal and fuel oil in the combustion processes. Abatement equipment operates since 2008 (for both plants).

In a wet flue gas desulfurization the SO₂ emissions are absorbed by lime, forming CO₂ and plaster (gypsum + H₂O) as by-products.

Equation 4-23: Chemical conversion equations

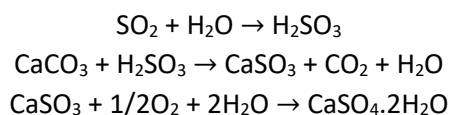

These equations show that the wet flue gas desulfurization reduces the SO₂ emissions but increment CO₂ emissions.

Since there is no specific CRF category for desulfurization, and given it derives from carbonates consumption, total CO₂ emissions from this abatement system were included in category 2.A.4.d.



4.2.12.2 Methodology

Carbonates uses in Fertilizers

CO₂ emissions are estimated from the quantification of carbon in original raw materials, and making a mass balance for the quantities of CO₂ that are liberated in the conversion process. Therefore emissions are estimated from consumption of carbonate materials:

Equation 4-24: CO₂ emissions

$$Emi_{CO_2} = 44/12 \times Mat_{Carb(m)} \times EF_{(m)} \times 10^{-3}$$

Where:

Emi_{CO₂}: CO₂ emissions (kt CO₂)

Mat_{Carb(m,y)}: Consumption of carbonate containing material m (t)

EF_(m): Emission factor of material m consumption (t CO₂/t material m)

Desulfurization in Large Point Source Energy Plants in Mainland Portugal

In the desulfurization processes it is important to determine the emission of CO₂ and the reduction of SO₂. For both determinations the lime consumption was used as activity data:

Equation 4-25: CO₂ emissions

$$CO_2 \text{ Emission}_{(u,y)} = CaCO_{3Cons(u,y)} \times CO_2Ratio \times 10^{-3}$$

Equation 4-26: SO₂ removals

$$SO_2 \text{ Removal}_{(u,y)} = CaCO_{3Cons(u,y)} \times SO_2Ratio \times 10^{-3}$$

Where:

CO₂ Emission_(u,y): Emission of CO₂ estimated from CaCO₃ consumption in power plant u in year y (t)

SO₂ Removal_(u,y): Quantity of SO₂ not emitted estimated from CaCO₃ consumption in power plant u in year y (t)

CaCO_{3Cons(u,y)}: Consumption of CaCO₃ in power plant u in year y (t)

CO₂Ratio: Ratio between CO₂ emitted and CaCO₃ consumption

SO₂Ratio: Ratio between the SO₂ removed and CaCO₃ consumption

Since both energy plants are included in the EU-ETS, the CO₂ ratio reported under this scheme was used in the inventory – 0.44 t CO₂/t Ca. Monitoring data from the two plant was used for determining the SO₂ ratio: estimation based in CaCO₃ consumption and the difference between the expected SO₂ emissions without abatement system (based in the fuel sulphur content) and what was actually emitted. Because of this the SO₂ ration is plant specific and varies over time.

Since the methodology for determining combustion SO₂ does not consider the use of abatement systems, the quantity of SO₂ removed in the desulfurization equipment will be subtracted to the total SO₂ emissions.



4.2.12.1 Emission Factors

Emission factors of materials consumed in Portugal was set from molecular stoichiometry⁸:

Table 4-23: Emission factors of carbonate materials

Material	EF
Limestone (1)	0.44
Dolomite (2)	0.48
(1) assumed pure calcium carbonate	
(2) Ca and Mg carbonate in equal share	

4.2.12.2 Activity Data

Carbonates uses in Fertilisers

Due to the unavailability of statistical information concerning consumption of carbonate materials in the fertilizer industry (for the production of calcium and magnesium nitrates) they had to be estimated from fertilizer production data and considering that, stoichiometrically, two moles of nitrogen require one mole of either CaCO_3 or MgCO_3 . From 1992 onwards, fertilizer production data was also available from INE database. In the period 1990-1991, data has been estimated based on the average 1992-1996 production and on GDP for the 1990-1991 period.

Final total consumption of carbonate materials is presented in the figure below. In the period 2010-2011 there is a strong decrease in limestone and dolomite consumption related to a decrease in calcium nitrate production.

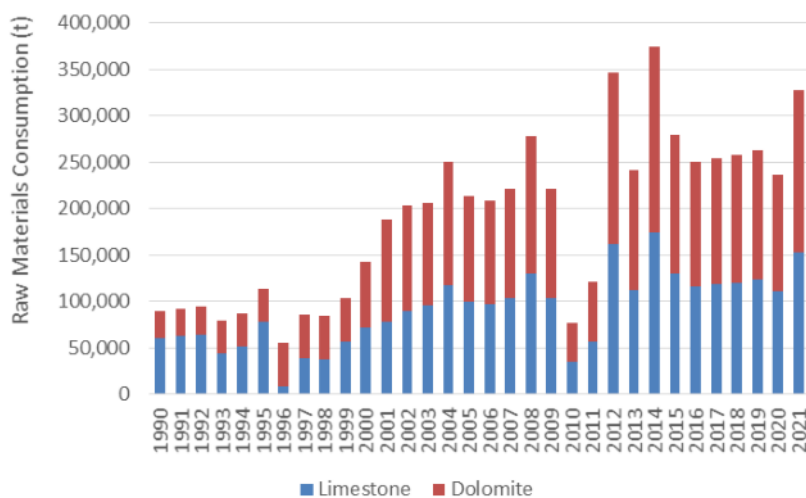

Figure 4-24: Consumption of carbonate materials in fertilizer industry

Desulfurization in Large Point Source Energy Plants in Mainland Portugal

From 2008 (when desulfurization began in both plants) onwards, total limestone consumed for desulfurization in each plant was obtained from the EU-ETS. For confidentiality constraints and since there are only two plants in Portugal that use this kind of abatement system, the CaCO_3 consumption cannot be reported.

⁸ It was assumed that limestone was totally pure, which causes over-estimated emissions.



4.2.12.3 Uncertainty Assessment

Table 4-24: Uncertainty values

Parameter	Type of Uncertainty	Uncertainty	Source
Activity Data	Weighing or proportioning raw materials	2.0% (average of 1.0-3.0% range)	Table 2.3 of "Chapter 2: Mineral Industry Emissions" of "2006 IPCC Guidelines for National Greenhouse Gas Inventories"
Activity Data	Carbon content	2.0%	Table 2.3 of "Chapter 2: Mineral Industry Emissions" of "2006 IPCC Guidelines for National Greenhouse Gas Inventories"
Activity Data	Combined Uncertainty	2.8%	-
CO2 EF	Fractional purity	3.0% (average of 1.0-5.0% range)	Average value of the range 1-5% of chapter 2.5.2.1 of Volume 3: Industrial Processes and Product Uses of 2006 IPCC Guidelines for National Greenhouse Gas Inventories.

4.2.12.4 Category specific QA/QC and verification

QA/QC procedures included a series of checks: calculation formulas verification, data and parameters verification and the information provided in this report.

4.2.12.5 Recalculations

No recalculations were made.

4.2.12.6 Further Improvements

Efforts will be made in order to obtain necessary statistical information or alternative methodologies to estimate emissions from carbonate use in the production of synthetic fertilizers (nitrates of calcium and magnesium and ammonium nitrate with calcium and magnesium).

4.2.13 Other - Rock wool Production (CRF 2.A.5)

4.2.13.1 Category description

Rock wool is a category of mineral wool, where the production process is similar to glass making, already addressed in chapter 2.A.3.

There is rock wool production in Portugal at least since 1974, from one facility. In 1997, that facility was deactivated (and was never included in EU-ETS) and gave place to a new one, which has been working ever since. In 2004, a new facility has begun operating and has been working ever since. There was another facility, which operated from 2009 to 2012, however, had insufficient installed capacity to be included in EU-ETS. All facilities above mentioned are owned by the same company.

In short, currently there are two operating rock wool production plants in Portugal, both included in EU-ETS system since 2008. Rock wool from these facilities is produced from basalt and limestone. It is made submitting these materials to a high temperature, causing them to melt.

According to the 2006 IPCC Guidelines, where the production of rock wool is emissive, these emissions should be reported under IPCC Subcategory 2A5. However, since CRF tables do not include category 2.A.5, CO₂ emissions from rock wool production are reported in category 2.A.4.d.

Combustion emissions from Rock wool production are reported in source sector 1.A.2, estimated from fuel consumption data.



4.2.13.2 Methodology

From 1974 to 1996, rock wool was made entirely from basalt and not from limestone. From 1997 onwards, limestone was added to the process, in order to correct any deviations to basalt's chemical composition. However, basalt is still, by far, the predominant raw material.

In 2006 IPCC guidelines there is no CO₂ emission factor for basalt and no methodology for estimating emissions from rock wool production. Also, EU-ETS only reports limestone consumption data for these facilities and not basalt consumption.

Furthermore, we assume that basalt's composition does not include carbonates, therefore, CO₂ process emissions from rock wool production originate only from limestone as raw material.

Resuming, it is assumed that no CO₂ emissions occur from carbonates when basalt is the only raw material (no CO₂ process emissions from rock wool production in the period 1990-1996).

CO₂ emissions from rock wool production are Kiln Input based, estimated by the facilities according to No. 11 of Annex IV of Regulation (EU) No. 2066/2018 (<https://eur-lex.europa.eu/legal-content/pt/TXT/?uri=CELEX%3A32018R2066>). Calculation is based on the amount of carbonates in the raw materials consumed (Tier 3), according to the following equation:

Equation 4-27: CO₂ Emissions from rock wool production

$$\text{Emission}_{\text{CO}_2} = \text{Carbonate} \times \text{EF}_{\text{CO}_2} \times F$$

Where:

Emission_{CO₂}: CO₂ emissions from consumption of limestone (kt)

Carbonate: Amount of limestone consumed (t)

EF_{CO₂}: Emission factor from consumption of limestone (t CO₂/t of carbonate)

F: fraction of calcination achieved for limestone (0-1)

Given the fact that there is no calcination factor monitoring in EU-ETS, we assumed complete calcination, therefore, F equals 1 (100%).

4.2.13.3 Emission Factors

The following emission factor was considered:

Table 4-25: Emission Factors

Carbonate	EF	Unit EF
CaCO ₃	0.44	t CO ₂ /t carbonate

4.2.13.4 Activity Data

From 1990 to 2004, rock wool production was obtained from national statistics (IAPI/INE). From 2005 onwards, rock wool production was obtained directly from the facilities or from Environmental Annual Reports.

From 2005 onwards, limestone consumption was obtained directly from the facilities or from EU-ETS.

We contacted the company in order to provide us limestone consumption for the missing years (1997-2004), however, they no longer possess those data due to company restructuration or human resources allocation.

Given there is no EU-ETS system in the period 1997 to 2004, the splicing technique "overlap" (section 5.3.1.1 of the 2006 IPCC Guidelines) was used in order to estimate limestone consumption, according to the following equation:



Equation 4-28: Limestone consumption - 1997-2004

$$Limestone\ Cons_y = Rock\ wool\ Prod\ NS_y \times \frac{Limestone\ Cons_{2005-2009}}{Rock\ wool\ Prod\ NS_{2005-2009}}$$

Where:

Limestone Cons_y: Limestone consumption in year y (t)

Rock wool Prod NS_y: Rock wool production from national statistics in year y (t)

Limestone Cons₂₀₀₅₋₂₀₀₉: Average plant specific limestone consumption in period 2005-2009 (t)

Rock wool Prod NS₂₀₀₅₋₂₀₀₉: Average Rock wool production from national statistics in period 2005-2009 (t)

In order to ensure time series consistency, the overlap technique to backcast limestone consumption for the missing years was based on rock wool production from national statistics and the average data from EU-ETS for 2005-2009. We decided to fix the data used to the retropolation as the average on the 2005-2009 in order to avoid yearly corrections associated to the introduction of last year ratios.

Rock wool production and limestone consumption are presented in the figure below for the whole time series.

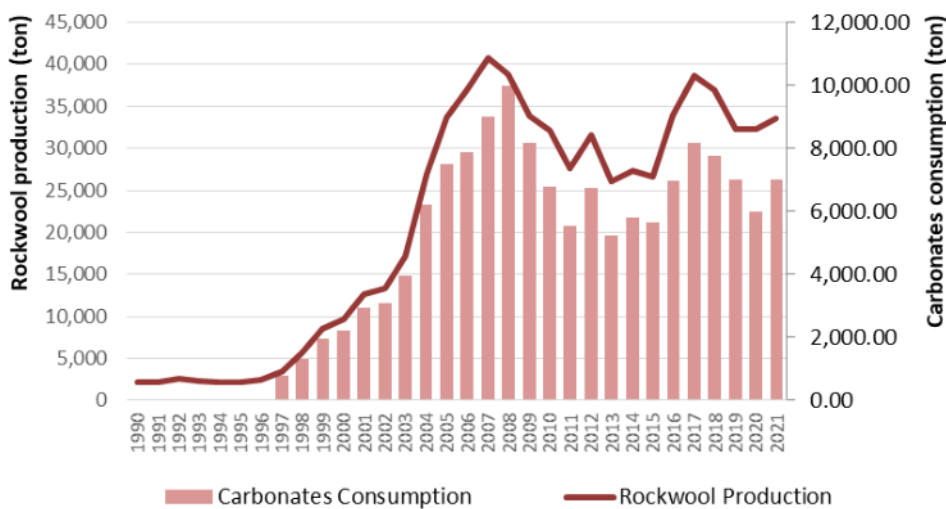

Figure 4-25: Limestone consumption and rock wool production

4.2.13.5 Uncertainty Assessment

Table 4-26: Uncertainty values related to emissions reported under CRF 2.A.4.d – Rock Wool Production

Parameter	Type of Uncertainty	Uncertainty	Source
Activity Data	Weighing or proportioning raw materials	2.0% (average of 1.0-3.0% range)	Subchapter 2.4.2.2 of chapter 2: Mineral Industry Emissions of 2006 IPCC Guidelines for National Greenhouse Gas Inventories.
Activity Data	Rock Wool Production	5.0%	Subchapter 2.4.2.2 of chapter 2: Mineral Industry Emissions of 2006 IPCC Guidelines for National Greenhouse Gas Inventories.
Activity Data	Combined Uncertainty	5.4%	-
CO2 EF	Stoichiometric ratio	2.0% (average of 1.0-3.0% range)	Subchapter 2.4.2.1 of chapter 2: Mineral Industry Emissions of 2006 IPCC Guidelines for National Greenhouse Gas Inventories.
CO2 EF	Calcination of the carbon input	1.0%	Subchapter 2.4.2.1 of chapter 2: Mineral Industry Emissions of 2006 IPCC Guidelines for National Greenhouse Gas Inventories.
CO2 EF	Combined Uncertainty	2.2%	-



4.2.13.6 Category specific QA/QC and verification

QA/QC procedures included a series of checks: calculation formulas verification, data and parameters verification and the information provided in this report.

4.2.13.7 Recalculations

No recalculations were made.

4.2.13.8 Further Improvements

No further improvements are planned.



4.3 Chemical Industry (CRF 2.B)

4.3.1 Overview

This chapter is intended to estimate process-related GHG emissions that result from the production of various inorganic and organic chemicals, which have significant contributions to global or individual national greenhouse gas emission levels.

Most chemical sector companies in Portugal are small and micro companies, mostly operating in the area of consumer products. Larger operators are active in basic chemicals, fertilizers, petrochemicals, polymers, fibers and specialties. There is also a small but very dynamic group of companies in the fine chemicals area, with a significant contribution to value added exports (Source: CEFIC).

There are no significant CO₂, CH₄ and N₂O emissions to report in chemical production in Portugal. However, there are mostly indirect CO₂ emissions related to NMVOC. The methodology used to estimate NMVOC emissions could be checked in the Portuguese IIR. Indirect CO₂ emissions related to NMVOC emissions from chemical industry are reported in CRF Table 6.

4.3.2 Ammonia Production (CRF 2.B.1)

4.3.2.1 Category description

In 1990 there were two facilities producing ammonia in Portugal, but one of them stopped activity already in the beginning of that year. From 1991 to 2008 there was only one facility producing ammonia. In 2009, this facility was restructured and the ammonia production unit was relocated to India.

Ammonia is synthesized from nitrogen and hydrogen, by the following reaction:

Equation 4-29: Chemical conversion equation

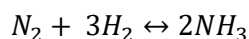

Nitrogen is obtained from atmospheric air.

Depending on the type of fossil fuel, two different methods were applied to produce the hydrogen for ammonia production: steam reforming or partial oxidation. In Portugal, hydrogen was obtained from partial oxidation of a very high viscosity residue RAAV (heavy fraction from petroleum distillation). This process was very flexible in terms of fuel input, allowing the use of the heavier fractions of oil distillation, namely vacuum residues, due to its smaller range of applications and also because they were available on the market at lower prices. Given that no detailed information is available concerning the type of fuel used, it is assumed the fuel was very variable in terms of composition, since it was a residue from petroleum distillation, not subject to refining.

Gasification of heavy hydrocarbons follows the reaction:

Equation 4-30: Chemical conversion equation

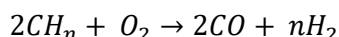

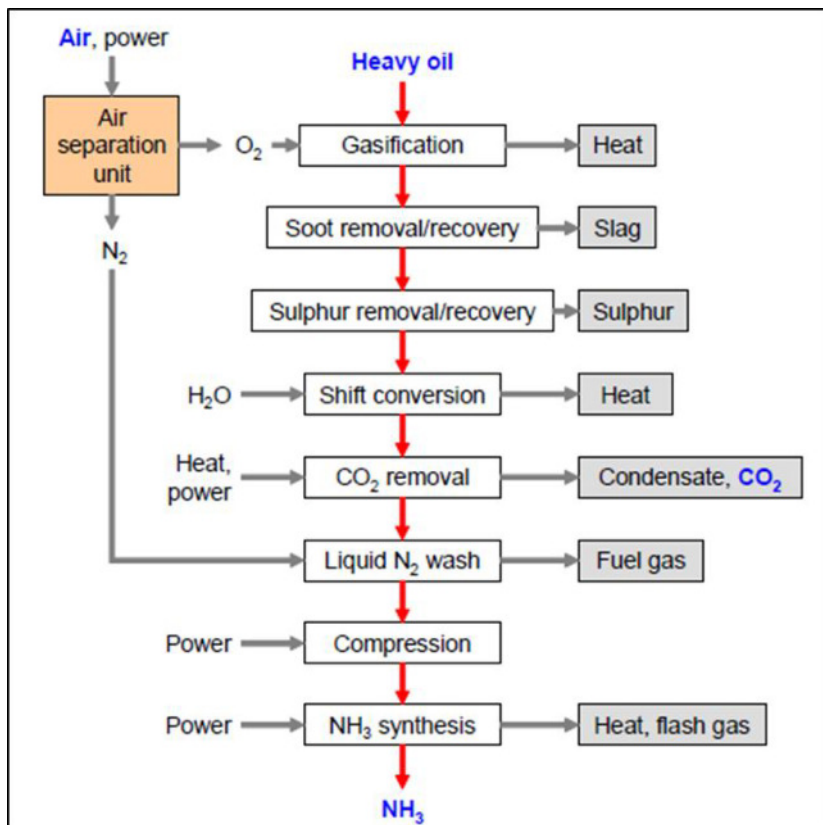

Source: Best available techniques Reference document developed under the IPPC Directive and the IED

Figure 4-26: Ammonia Production by Partial Oxidation

After cooling the exit gas from the shift conversion, the process condensate is separated. The gas is chilled and scrubbed with chilled methanol (imported), which absorbs CO₂ and H₂S. Pure CO₂, may be used for urea production, and these amounts need to be subtracted to CO₂ emissions estimated based on NH₃ production in order to avoid double counting.

Other pollutants that result from the process, either from escape of ammonia (NH₃) or either from release of products from feedstock, like CO. The methodology used to estimate CO emissions could be checked in the Portuguese IIR. Indirect CO₂ emissions related to CO emissions from ammonia production are reported in CRF Table 6.

NM VOC emissions from ammonia production by partial oxidation are reported as Not Estimated.

Urea is synthesized from NH₃ and CO₂, which are fed into the reactor at high pressure and temperature, following the two step reaction below:

Equation 4-31: Chemical conversion equations

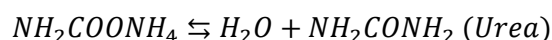

4.3.2.2 Methodology

Information regarding the production process, ammonia production data as well as urea production is available at plant level. However, the facilities were unable to provide information on fuel type, nor its carbon content.

Therefore, CO₂ emissions from ammonia production were estimated using a Tier 1 methodology according to equation 3.1 from chapter 3.2.2.1 of Volume 3 IPPU of the 2006 IPCC Guidelines:

**Equation 4-32: CO₂ emissions from ammonia production**

$$E_{CO_2} = AP \times FR \times CCF \times COF \times \frac{44}{12} - R_{CO_2}$$

Where:

E_{CO_2} : CO₂ emissions from ammonia production (kg)

AP: Ammonia production (t)

FR: Fuel requirement per unit of output (GJ/ton ammonia produced)

CCF: Carbon content factor of the fuel (kg C/GJ)

COF: Carbon oxidation factor of the fuel (%)

R_{CO_2} : CO₂ recovered for downstream use in urea production (kg)

CO₂ recovered for downstream use was estimated based on the quantity of urea produced, according to page 3.12 of chapter 3.2.2.1 of Volume 3 IPPU of the 2006 IPCC Guidelines. CO₂ emissions are estimated by multiplying urea production by 44/60, the stoichiometric ratio of CO₂ to urea, according to the following equation:

Equation 4-33: CO₂ recovered for urea production

$$R_{CO_2} = UP \times \frac{M(CO_2)}{M(Urea)}$$

Where:

R_{CO_2} : CO₂ recovered for urea production (kt)

UP: Urea production (kt)

M(CO₂): Molar mass of CO₂ (44 g/mol)

M(Urea): Molar mass of Urea (60 g/mol)

4.3.2.3 Emission Factors

Default parameters and emissions factor applied were taken from Table 3.1 of chapter 3.2.2.2 of Volume 3 IPPU of the 2006 IPCC Guidelines and are listed in the table below.

According to the guidelines, for the Tier 1 method, if no information on fuel type is available, it is good practice to use the average value shown in Table 3.1 for partial oxidation (production process used in Portugal from 1990 to 2008).

Table 4-27: Emission Factors and parameters considered

Production / Process	Parameter	Unit	Value
Average value- partial oxidation	Total fuel requirement	GJ/ton NH ₃	42.5
	Carbon content	kg/GJ	21.0
	Carbon oxidation factor	fraction	1

4.3.2.4 Activity Data

In 1990 there were two plants producing ammonia in Portugal, but one of the plants stopped activity already in the beginning of that year. From 1991 to 2008 there was only one plant producing ammonia. In 2009, this plant was restructured and the ammonia production unit was relocated to India.



In the period 1990-2008, ammonia and urea production data were obtained from the facilities. From 2009 onwards there is no ammonia production. Data is consistent with national statistics ammonia production data. Concerning fuel requirements, upon several contacts, ammonia production facilities indicated that they have long since terminated ammonia production and do not possess such old data due to company restructuring.

Due to confidentiality constraints, ammonia and urea production are presented in the figure below as an index value related to 1990 data. It is evident the significant inter-annual changes in the period 1991-1996. According to information provided by the facility, the sharp decrease in the period 1992-1994 was due to technical problems that led to several interruptions in the production.

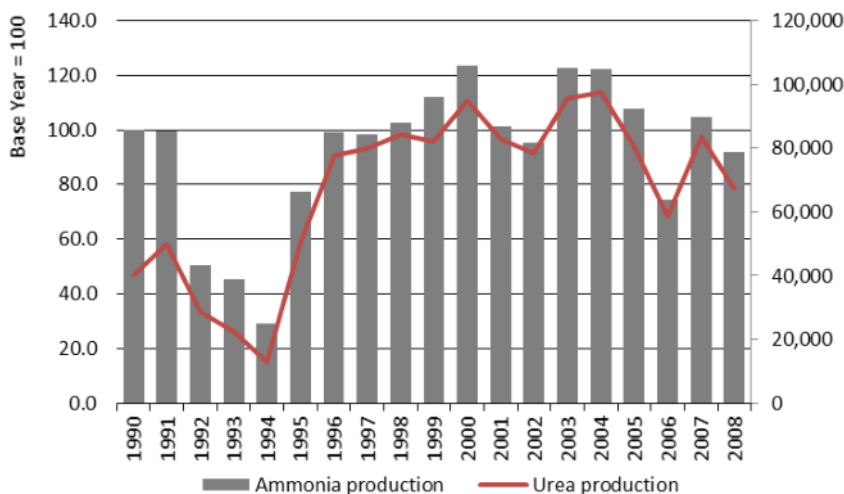

Figure 4-27: Trend in Ammonia and Urea production

4.3.2.5 Uncertainty Assessment

Table 4-28: Uncertainty values

Parameter	Type of Uncertainty	Uncertainty	Source
Activity Data	Ammonia Production	2%	Subchapter 3.2.3.2 of Chapter 3: Chemical Industry Emissions of 2006 IPCC Guidelines for National Greenhouse Gas Inventories.
Activity Data	Urea Production	2%	
CO ₂ EF	Fuel requirement	7%	Table 3.1 of Chapter 3: Chemical Industry Emissions of 2006 IPCC Guidelines for National Greenhouse Gas Inventories.

4.3.2.6 Category specific QA/QC and verification

QA/QC procedures included a series of checks: calculation formulas verification, data and parameters verification and the information provided in this report.

A comparison was made using a top-down approach based on ammonia production data obtained from national production statistics (IAPI) from 1990 to 2009. We intend to further investigate the differences between the two approaches in the period 1994-1998, other than that, data is generally consistent.

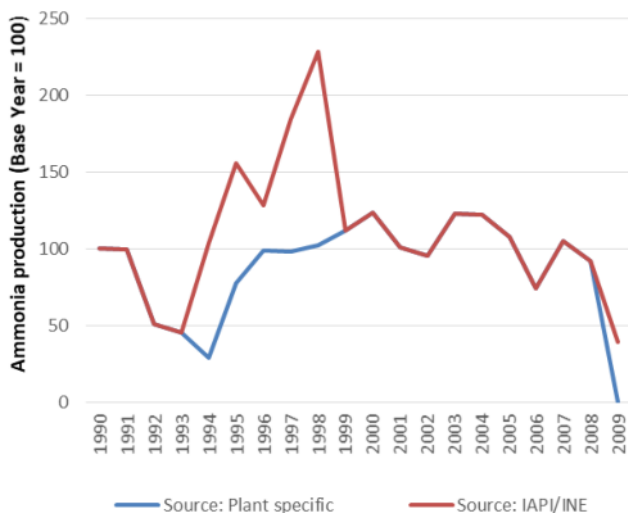

Figure 4-28: Ammonia production data – comparison of approaches

4.3.2.7 Recalculations

No recalculations were made.

4.3.2.8 Further Improvements

As good practice, Portugal acknowledges and pursues the application of Tier 2 methodologies or higher for Key Categories as much as technically possible.

However, in order to do so, it is required specific information from the ammonia production facilities such as fuel requirement and its carbon content and carbon oxidation factor. Portugal does not possess data on fuel input in ammonia production such as the described above. Upon contact in order to obtain these data, the facilities informed that they did not possess such old data due to company restructuration, since they have long since terminated ammonia production.

Therefore, no further improvements are planned, due to lack of data from the facilities.

4.3.3 Nitric Acid Production (CRF 2.B.2)

4.3.3.1 Category description

Currently, three industrial plants produce nitric acid in Portugal. In 2 units, weak nitric acid (60 %) is produced from ammonia, using catalytic (Platinum-rhodium alloy catalysts) oxidation of ammonia with air to NO_2 at medium pressure, and subsequent absorption with water to form nitric acid in a dual-stage process. From 1990 to 2011 there was also another nitric acid facility operating at “dual-pressure” medium/high (M/H). This facility, however, was closed during 2011 and was replaced by a new facility, which began operating in 2010 also at “dual-pressure” medium/high (M/H).

Nitric Acid production results in air emissions of Nitrous Oxide (N_2O), NO_x (NO and NO_2), trace amounts of HNO_3 acid mist and ammonia (NH_3). The great majority of emissions are conveyed in the tail gas from the absorption tower. NO_x and NH_3 emissions from Nitric Acid production are estimated and reported in the Portuguese IIR.

4.3.3.2 Methodology

Since there are different data sources available depending on the years, two different methodologies were used throughout the time series.



From 2013 onwards, N₂O emissions are estimated by facilities according to No. 16 of Annex IV of Regulation (EU) No. 2066/2018 (<https://eur-lex.europa.eu/legal-content/pt/TXT/?uri=CELEX%3A32018R2066>) and reported directly under the EU-ETS.

From 1990 to 2012, N₂O emissions are estimated according to the following equation:

Equation 4-34: N₂O Emissions from nitric acid production

$$E_{N_2O} = NP \times EF_{N_2O} \times 10^{-3}$$

Where:

E_{N₂O}: N₂O emissions from nitric acid production (t)

NP: Nitric Acid production (t)

EF_{N₂O}: N₂O Emission factor (kg/t)

4.3.3.3 Emission Factors

Regarding the nitric acid facility in operation from 1990 to 2011, due to lack of information, N₂O emission factor applied for the whole time series is a default value (Tier 1) from Table 3.7 of the BREF for the Production of Large Volume Organic Chemicals (2007) for medium/high pressure nitric acid facilities - 6.7 kg/ton HNO₃.

Regarding the nitric acid facility in operation from 2010 onwards (which replaced the later above):

- . from 2013 onwards, Tier 3 N₂O emission factors are collected from EU-ETS;
- . from 2010 to 2012, in order to ensure time series consistency, N₂O emission factor is based on the average EU-ETS N₂O emission factors in the period 2013-2017.

Regarding the other 2 nitric acid facilities:

- . from 2013 onwards, Tier 3 N₂O emission factors are collected from EU-ETS;
- . from 1990 to 2012, Tier 3 N₂O emission factors are based on monitoring data obtained from facilities.

Table 4-29: Emission Factors considered

Facility	Period	Parameter	Value	Unit	Source
1	1990-2011	EF	6.7	kg/ton HNO ₃	Table 3.7 of the BREF for the Production of Large Volume Organic Chemicals (2007) for medium/high pressure nitric acid facilities
2	2010-2012	EF	0.112	kg/ton HNO ₃	EU-ETS (average EF from 2013-2017)
	2013-onwards	EF	0.039-0.117	kg/ton HNO ₃	EU-ETS
3 and 4	1990-2012	EF	confidential	kg/ton HNO ₃	Monitoring from facilities
	2013-onwards	EF	0.326-0.972	kg/ton HNO ₃	EU-ETS

Due to confidentiality constraints, it is not possible to publish the emission factors based on monitoring data.

Following contacts with the facilities, it was found that the variation in emissions is a result of the variation in nitric acid production and is expected within the range of operating conditions verified (capacity for heat recovery, state of the catalytic screens, fouling of various exchangers, etc.) and operating conditions of the unit of gas abatement (amount of NO_x and N₂O treated, tail gas temperature, etc.).

In 2010, Facility 3 implemented BAT “catalytic N₂O decomposition” in the reactor chamber, in order to reduce emissions of N₂O and to achieve lower emission factors or emission concentration levels. According to this BAT, N₂O can be decomposed in N₂ and O₂ just after being formed, by a selective De-N₂O catalyst in the high



temperature zone (between 800 and 950 °C). Additional information on this BAT can be consulted in BREF Large Volume Inorganic Chemicals – Ammonia, Acids and Fertilisers, published in 2007. The catalyst was installed in 19/11/2010, hence, as the result of this BAT implementation, a decrease in N₂O emissions from this facility was noted from 2011 onwards.

During 2009, Facility 4 also implemented BAT “catalytic N₂O decomposition” in the reactor chamber, hence a decrease in N₂O emissions from this facility was noted from 2010 onwards. In 2013, the catalyst was replaced by a new one, further decreasing N₂O emissions in this facility.

4.3.3.4 Activity Data

Nitric acid production is obtained directly from the facilities and from Environmental Annual Reports for the whole time series. One of the plants was closed during 2011 and was replaced by a new facility, which began operating in 2010. In 2020 there is a slight decrease in nitric acid production due to COVID19 pandemic.

The activity data that was used to estimate emissions from this sub-source sector is subjected to confidentiality constraints due to the limited number of existing production units and therefore is presented in the figure below in relation to production in 1990 (trends).

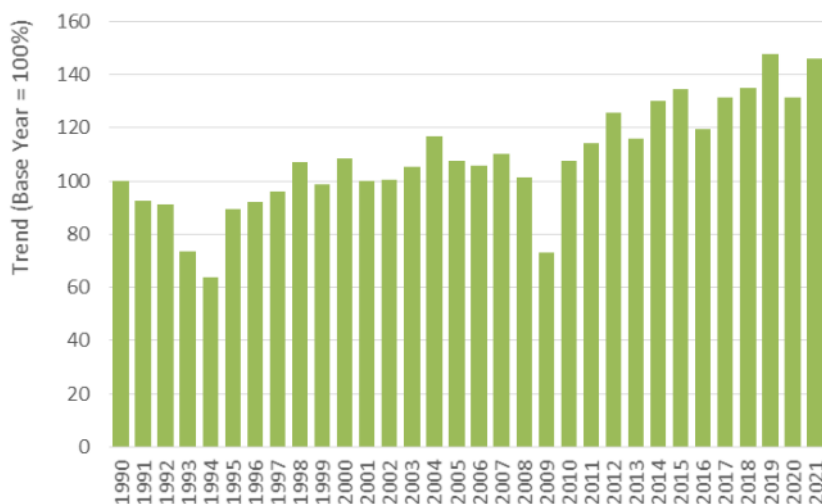

Figure 4-29: Trend in Nitric Acid production

4.3.3.5 Uncertainty Assessment

Table 4-30: Uncertainty values

Parameter	Type of Uncertainty	Uncertainty	Source
Activity Data	Nitric Acid Production	2%	Subchapter 3.3.3.2 of Chapter 3: Chemical Industry of 2006 IPCC Guidelines.
N ₂ O EF	N ₂ O emission factor	20%	Table 3.3 of Chapter 3: Chemical Industry of 2006 IPCC Guidelines.

Nitric Acid production data was obtained directly from the plants (2% uncertainty).

4.3.3.6 Category specific QA/QC and verification

QA/QC procedures included a series of checks: calculation formulas verification, data and parameters verification and the information provided in this report.

4.3.3.7 Recalculations

No recalculations were made.



4.3.3.8 Further Improvements

No further improvements are planned.

4.3.4 Adipic Acid Production (CRF 2.B.3)

There is no adipic acid production in Portugal.

4.3.5 Caprolactam, Glyoxal and Glyoxylic Acid Production (CRF 2.B.4)

There is no caprolactam, glyoxal or glyoxylic acid production in Portugal.

4.3.6 Silicon Carbide and Calcium Carbide Production (CRF 2.B.5)

There is no silicon carbide or calcium carbide production in Portugal.

4.3.7 Titanium Dioxide Production (CRF 2.B.6)

4.3.7.1 Category description

This chapter addresses emissions estimates from the production of Titanium dioxide (TiO₂). TiO₂ pigments are made from one of two chemical processes: the chloride route, which leads to TiO₂ products by reacting titanium ores with chlorine gas; and the sulphate route, which leads to TiO₂ products by reacting titanium ores with sulphuric acid. In both processes, pure TiO₂ powder is extracted from its mineral feedstock after which it is milled and treated to produce a range of products designed to be suitable for efficient incorporation into different substrates.

Titanium dioxide production generates CO₂ emissions, as well as SO_x, NO_x, CO and particulate matter. The methodology used to estimate atmospheric pollutants can be checked in the Portuguese IIR. Indirect CO₂ emissions related to CO emissions from titanium dioxide production are reported in CRF Table 6.

4.3.7.2 Methodology

Emissions are estimated using a Tier 1 approach according to the following equation:

Equation 4-35: CO₂ emissions from titanium dioxide production

$$E_{CO_2} = \frac{(AD_{Chloride} \times EF_{Chloride} + AD_{Sulphate} \times EF_{Sulphate})}{1000}$$

Where:

E_{CO₂}: CO₂ emissions from Titanium Dioxide production (t)

AD_{Chloride}: Titanium Dioxide produced by the Chloride Process (t)

EF_{Chloride}: CO₂ EF related to Titanium Dioxide produced by the Chloride Process (t CO₂/t TiO₂)

AD_{Sulphate}: Titanium Dioxide produced by the Sulphate Process (t)

EF_{Sulphate}: CO₂ EF related to Titanium Dioxide produced by the Sulphate Process (t CO₂/t TiO₂)



4.3.7.3 Emission Factors

Table 4-31: CO₂ emission factors related to TiO₂ production

Pollutant	Process	Unit	EF	Source
CO ₂	Chloride Process	t CO ₂ /t TiO ₂	1.34	Table 3.9 of "Chapter 3: Chemical Industry Emissions" of 2006 IPCC Guidelines for National Greenhouse Gas Inventories.
	Sulphate Process	t CO ₂ /t TiO ₂	1.43	

4.3.7.4 Activity Data

From 2014 onwards, Titanium Dioxide production data was obtained from EUROSTAT.

There is no information on the share of each technology/practice. We considered the share proposed in the BREF document of «Large Volume Inorganic Chemicals – Solids and Others», and assume that 30% of the Titanium Dioxide is produced by the Chloride Process and 70% by the Sulphate Process.

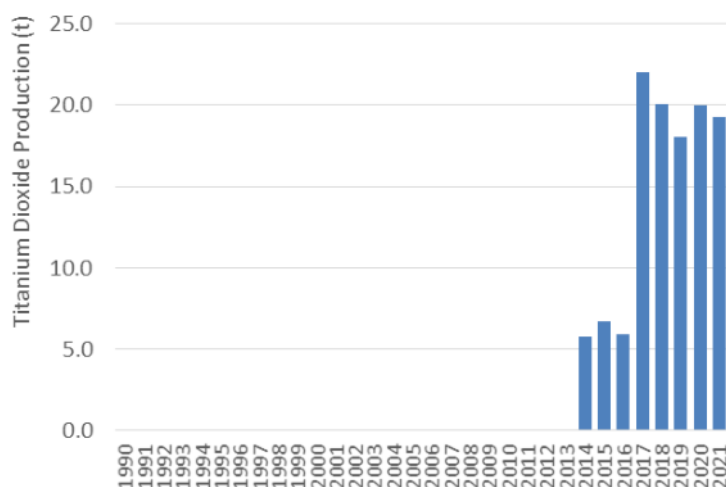

Figure 4-30: Trend in Titanium Dioxide Production

4.3.7.5 Uncertainty Assessment

Table 4-32: Uncertainty values

Parameter	Type of Uncertainty	Uncertainty	Source
Activity Data	Titanium Dioxide Production	2%	Expert Judgement
CO ₂ EF	Chloride Process	15%	Table 3.3 of Chapter 3: Chemical Industry Emissions of 2006 IPCC Guidelines for National Greenhouse Gas Inventories.
	Sulphate Process	10%	

4.3.7.6 Category specific QA/QC and verification

QA/QC procedures included a series of checks: calculation formulas verification, data and parameters verification and the information provided in this report.

4.3.7.7 Recalculations

No recalculations were made.

4.3.7.8 Further Improvements

Efforts will be made in order to check the reason why Titanium Dioxide production data is reported in Eurostat but not in National Statistics, as well as to obtain the share of each Titanium Dioxide technology in Portugal, by collecting plant specific data.



4.3.8 Soda Ash Production (CRF 2.B.7)

In Portugal there was only one plant producing Soda Ash by the Solvay process. CO₂ was generated in two pyrolysis processes, captured, compressed and directed to Solvay precipitating towers for consumption in a mixture of brine (aqueous NaCl) and ammonia. Although CO₂ is generated as a by-product, it is recovered and recycled for use in the carbonation stage and in theory the process is neutral, i.e., generation of CO₂ equals uptake.

Upon a contact with the facility, we were informed that soda ash production terminated in 2014.

4.3.9 Petrochemical and Carbon Black Production – Methanol (CRF 2.B.8.a)

There is no methanol production in Portugal.

4.3.10 Petrochemical and Carbon Black Production – Ethylene (CRF 2.B.8.b)

4.3.10.1 Category description

There is only one ethylene production plant in Portugal, located in the southern part of the country, near Sines. The basic process in this unit is by Thermal Steam Cracking of petroleum feedstock. This unit produces Low Density Poly Ethylene (LDPE) and High Density Poly Ethylene (HDPE) from ethylene. As by product of ethylene production, other organic compounds are produced, such as propylene, butadiene and C4 fraction, aromatics and a residual fuel oil used in the unit as energy source.

Ethylene production results in CO₂, CH₄, as well as NMVOC emissions. The methodology used to estimate NMVOC emissions can be checked in the Portugal IIR. Indirect CO₂ emissions related to NMVOC emissions from ethylene production are reported in CRF Table 6.

4.3.10.2 Methodology

CO₂ and CH₄ emissions estimates were based on a Tier 1 approach according to the following:

Equation 4-36: CO₂ and CH₄ emissions from ethylene production

$$\text{Emission}_p = \text{EF}_p \times \text{AD} \times 10^{-3} \times \text{GAF}/100$$

Where:

Emission_p: Emission of pollutant p (t)

EF_p: Emission factor (kg/t Ethylene)

AD: Ethylene production data (t)

GAF: Geographic Adjustment Factor (%)

Since Portugal is located in Western Europe, according to Table 3.15 of Chapter 3 (Chemical Industry Emissions) of Vol.3 of the 2006 IPCC Guidelines, GAF was considered 100%.



4.3.10.3 Emission Factors

The following emission factors were applied:

Table 4-33: Emission Factors

Pollutant	Unit	EF	Source
CO ₂ EF	t CO ₂ /t ethylene	1.73	Table 3.14 of Chapter 3: Chemical Industry Emissions of 2006 IPCC Guidelines for National Greenhouse Gas Inventories
CH ₄ EF	kg CH ₄ /t ethylene	3.00	Table 3.16 of Chapter 3: Chemical Industry Emissions of 2006 IPCC Guidelines for National Greenhouse Gas Inventories

4.3.10.4 Activity Data

There is only one plant producing ethylene in Portugal. Ethylene production data was obtained from Environmental Annual Reports and cross-checked with national statistics data (QA/QC).

Due to confidentiality constraints, activity data is presented as an index value related to 1990 data for the whole time series. The sharp decrease in ethylene production in 2018 was due to an interruption in the production lines.

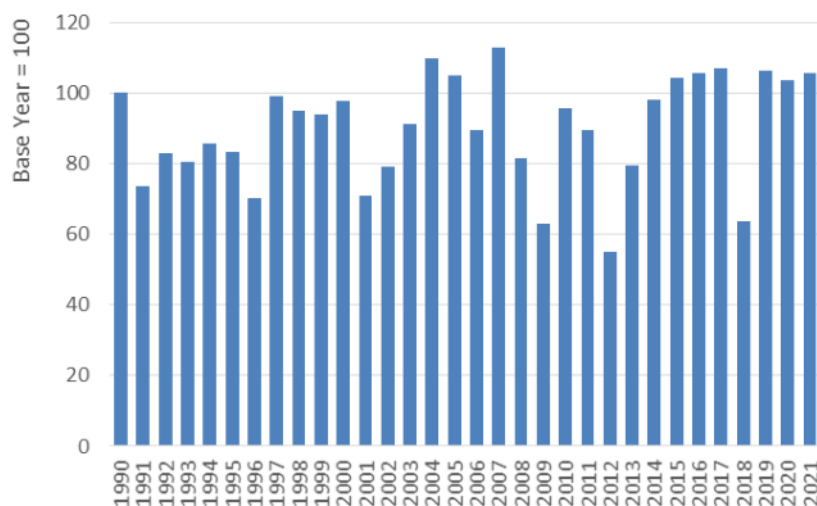

Figure 4-31: Trend in Ethylene production

4.3.10.5 Uncertainty Assessment

Table 4-34: Uncertainty values

Parameter	Type of Uncertainty	Uncertainty	Source
Activity Data	Ethylene Production	10%	Subchapter 3.9.3 of Chapter 3: Chemical Industry Emissions of 2006 IPCC Guidelines for National Greenhouse Gas Inventories
CO ₂ EF	CO ₂ emission factor for ethylene production	10%	
CH ₄ EF	CH ₄ emission factor for ethylene production	10%	

4.3.10.6 Category specific QA/QC and verification

Emissions estimates were based on a bottom-up approach with collection of plant specific ethylene production data. A comparison was made using a top-down approach based on ethylene production data obtained from national production statistics (IAPI). We only present data from 1996 onwards given the lack of national statistics ethylene production data from 1990 to 1995. As presented in the figure below, from 1996 onwards data is consistent using the two approaches.

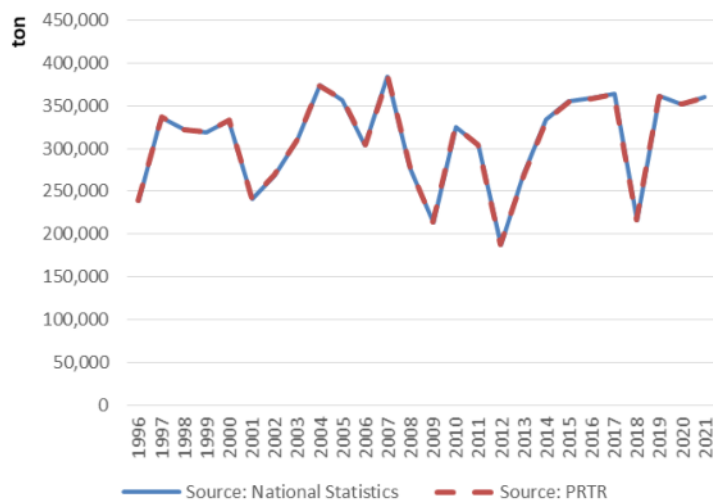

Figure 4-32: Ethylene production data – comparison of approaches

4.3.10.7 Recalculations

No recalculations were made.

4.3.10.8 Further Improvements

In the future, we intend to revise the emission factors based on monitoring data.

4.3.11 Petrochemical and Carbon Black Production – Ethylene Dichloride and Vinyl Chloride Monomer (VCM) (CRF 2.B.8.c)

Following a question regarding VCM production in the 2022 UNFCCC Review, upon investigation, the Party found there is no ethylene dichloride production in Portugal.

Concerning vinyl chloride monomer (VCM) production, following a 2022 review recommendation, further contacts to our Focal Points confirmed that currently there is no such activity in the country.

There is only one company in Portugal using VCM as raw material for the production of polyvinylchloride (PVC). Further contacts to the facility confirmed that they had its own VCM production line from 1963 to 1986. The annual production of VCM in that period varied from 3,200 to 14,000 tons. From 1987 onwards, VCM is imported.

VCM production is reported as NO for the whole time series. Recalculations for this category resulted in decreases between 26-40kt in CO₂ emissions and between 0.34-0.52t in CH₄ emissions for the whole time series.

4.3.12 Petrochemical and Carbon Black Production – Ethylene Oxide (CRF 2.B.8.d)

There is no ethylene oxide production in Portugal.

4.3.13 Petrochemical and Carbon Black Production – Acrylonitrile (CRF 2.B.8.e)

There is no acrylonitrile production in Portugal.



4.3.14 Petrochemical and Carbon Black Production – Carbon Black (CRF 2.B.8.f)

4.3.14.1 Category description

There was only one carbon black facility in Portugal, located in the southern part of the country, near Sines. This facility produced carbon black by the Oil Furnace Process, a partial combustion process where feedstock with a high content of aromatic material was converted by incomplete combustion, thermal cracking and dehydrogenation to carbon black. Emissions resulted from Gas Vent, combined dryer vent and fugitive emission in the vacuum system vent.

Carbon black production resulted in emissions of CO₂, CH₄, as well as other atmospheric pollutants. The methodology used to estimate atmospheric pollutants emissions can be checked in the Portugal IIR. Indirect CO₂ emissions related to NMVOC and CO emissions from carbon black production are reported in CRF Table 6.

Carbon black production ceased in 2013.

4.3.14.2 Methodology

For this sub-sector emissions estimates are extensively based on the use of emission factors multiplied by quantity of material produced:

Equation 4-37: Emissions from black carbon production

$$\text{Emission}_{(p,y)} = \text{EF}_{(p)} \times \text{ActivityRate}_{(y)} \times 10^{-3}$$

Where:

Emission_(p,y): Annual emission of pollutant p in year y (t)

EF_(p): Emission factor (kg/t)

ActivityRate_(y): Indicator of activity in the production process. Quantity of product produced per year is used as a general rule for this emission source sector (t)

Where CO₂ emissions result from liberation of carbon in tail gas to atmosphere, emissions were estimated using a simple mass balance:

Equation 4-38: Carbon mass balance

$$C_{\text{TailGas}} \times 44/12 = C_{\text{Feedstock}} + C_{\text{AuxFuels}} - C_{\text{CarbonBlack}}$$

Where:

C_{TailGas}: Carbon emitted in tail gas (t C)

C_{Feedstock}: Carbon entered in feedstock (t C)

C_{AuxFuels}: Additional carbon entered into system in fuels (t C)

C_{CarbonBlack}: carbon stored in carbon black and not emitted to atmosphere (t C)

4.3.14.3 Emission Factors

In the period 2009-2012, carbon black industrial unit was subjected to a detailed inventory exercise. Consequently, emission factors were established and emission estimates were extended for the rest of the time series using carbon black production as indicator of activity rate. Carbon Gas emissions also include emissions suffering partial combustion.

**Table 4-35: Emission Factors for Carbon Black process emissions**

Pollutant	Emission factor	Unit	EF source
CO ₂	2,379	kg/t carbon black	Carbon Balance Approach
CH ₄	0.060	kg/t carbon black	IPCC 2006 Guidelines

4.3.14.4 Activity Data

Due to confidentiality constraints, carbon black production data is presented as an index value related to year 1990 production. Carbon black production terminated in 2013.

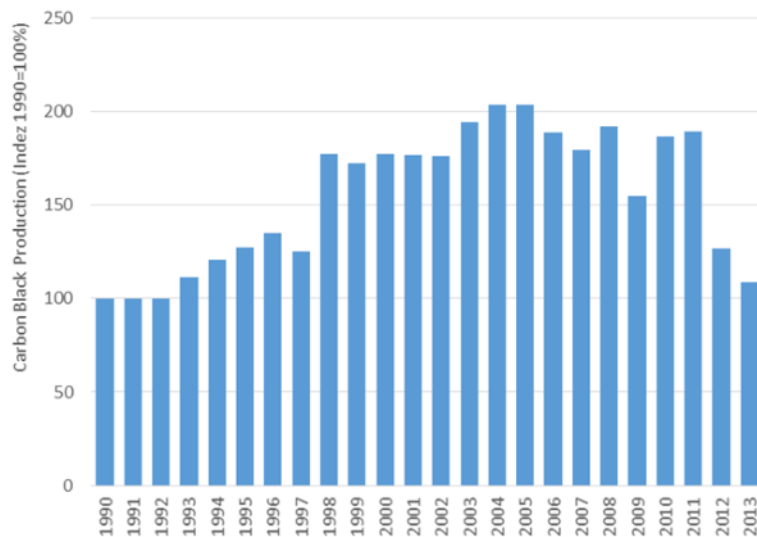
**Figure 4-33: Carbon Black production**

4.3.14.5 Uncertainty Assessment

The uncertainty of activity data received from Large Point Sources was set as 10 %.

4.3.14.6 Category specific QA/QC and verification

QA/QC procedures included a series of checks: calculation formulas verification, data and parameters verification and the information provided in this report.

4.3.14.7 Recalculations

No recalculations were made.

4.3.14.8 Further Improvements

No further improvements are planned.

4.3.15 Petrochemical and Carbon Black Production – Other (CRF 2.B.8.g)

This category includes the production of several chemical products such as: PEBD, PEAD, Polypropylene, Polystyrene, Formaldehyde, Phthalic Anhydride, Polyester, PVC, Polystyrene Foam and Polyurethane Foam.

Information on how emissions from these sub-categories are reported is given in the table below.

There are no direct CO₂, CH₄ and N₂O emissions from PEBD, PEAD, Polypropylene, Polystyrene, Formaldehyde and Phthalic Anhydride production. There are, however, NMVOC and CO emissions. The methodology used to estimate NMVOC and CO emissions can be checked in the Portugal IIR. Indirect CO₂ emissions related to NMVOC and CO emissions from these sub-categories are reported in CRF Table 6.



There are also no direct CO₂, CH₄ and N₂O emissions from the other 2.B.8.g sub-categories. There are, however, NMVOC emissions. The methodology used to estimate NMVOC emissions from the other sub-categories can also be checked in the Portugal IIR. Indirect CO₂ emissions related to NMVOC emissions from these other 2.B.8.g sub-categories are reported in CRF Table2(I).A-Hs1, under 2.B.8.g.

This report was agreed among EU countries with the aim of ensure consistency between KP commitment periods (CP). Countries, like Portugal, reported indirect CO₂ emissions from these other 2.B.8.g sub-categories in inventory submissions before 2015 (CP 1) in previous CRF table 3 (Sectoral report for solvents and other products use). Hence, for the following commitment period and in order to ensure the highest consistency with 2006 IPCC Guidelines and with the previous inventory submissions, countries should continue reporting these emissions in the same manner. Therefore, Portugal continues to report NMVOC emissions from the other 2.B.8.g sub-categories as indirect CO₂ emissions in CRF Table2(I).A-Hs1, for KP consistency purposes. On that matter, the paper “*Guidance related to the reporting of indirect emissions*” from EEA SHAREPOINT is presented in **ANNEX I** and includes further explanation to the approaches taken by Portugal and all other EU MS.

Table 4-36: Reporting of Other Petrochemical and Carbon Black Production

CRF	Category	Emissions	Reporting
2.B.8.gi	PEBD	NMVOC	CRF Table 6 – indirect CO ₂
2.B.8.gii	PEAD	NMVOC	
2.B.8.giii	Polypropylene	NMVOC	
2.B.8.giv	Polystyrene	NMVOC	
2.B.8.gv	Formaldehyde	NMVOC; CO	
2.B.8.gvi	Phthalic Anhydride	NMVOC; CO	
2.B.8.gvii	Polyamide Fiber	NMVOC	CRF Table2(I).A-Hs1 – direct CO ₂ (refer to indirect CO ₂ emissions)
2.B.8.gviii	Polyester	NMVOC	
2.B.8.gix	Polystyrene Foam	NMVOC	
2.B.8.gx	Polypropylene Fiber	NMVOC	
2.B.8.gxi	PVC Fiber	NMVOC	
2.B.8.gxii	Acrylic Fiber	NMVOC	
2.B.8.gxiii	Acrylonitrile Fiber	NMVOC	
2.B.8.gxiv	PVC	NMVOC	
2.B.8.gxv	Polyurethane Foam	NMVOC	

4.3.16 Fluorochemical Production (CRF 2.B.9)

There is no fluorochemical production in Portugal.

4.3.17 Other - Sulphuric Acid Production (CRF 2.B.10.a)

There are no direct CO₂, CH₄ and N₂O emissions to report in this subsector in Portugal.

There are, however, SO_x emissions from sulphuric acid production. The methodology used to estimate SO_x emissions from this category can be checked in Portugal IIR. SO_x emissions from sulphuric acid production are reported in CRF Table 2(I)s1.



4.3.18 Other – Explosives Production (CRF 2.B.10.c)

There are no direct CO₂, CH₄ and N₂O emissions to report in this subsector in Portugal. There are, however, SO_x and NO_x emissions from explosives production. The methodology used to estimate SO_x and NO_x emissions from this category can be checked in Portugal IIR. SO_x and NO_x from explosives production are reported in CRF Table 2(l)s1.

4.3.19 Other – Solvent Use in Plastic Manufacturing (CRF 2.B.10.d)

There are no direct CO₂, CH₄ and N₂O emissions to report in this subsector in Portugal. There are, however, indirect CO₂ emissions related to NMVOC. The methodology used to estimate NMVOC emissions from this category can be checked in the Portugal IIR. Indirect CO₂ emissions related to NMVOC emissions from Solvent Use in Plastic Manufacturing are reported in CRF Table 6.

These emissions are included and reported in sub-category 2.B.8.g.



4.4 Metal Industry (CRF 2.C)

4.4.1 Overview

This chapter is intended to estimate process-related GHG emissions that result from the production of various kinds of metals.

4.4.2 Iron and Steel Production (CRF 2.C.1)

4.4.2.1 Category description

Iron and steel production leads to CO₂, CH₄ and N₂O emissions. According to the 2006 IPCC Guidelines, N₂O emissions from Iron and Steel are likely to be small, hence no methodologies are provided for this GHG.

There are two iron and steel production plants operating in Portugal, dedicated to steel billets production, which are then processed mostly into long-product rolling like wire rod and rebar in straight lengths.

One of the plants started in 1976 and remained ever since as a secondary steel-making facility, producing steel mainly from recycled steel scrap in an Electric Arc Furnace (EAF).

The other plant started in 1961, as a primary facility that produced both iron and steel from iron ore as well as scrap, otherwise known as an integrated iron and steel production facility. Since this process did not consume all the available scrap, the surplus was also used to produce steel, but in an independent EAF. This facility integrated iron and steel production until 2001.

The following units were part of the integrated iron and steel production facility that operated from 1961 to 2001:

- Metallurgical Coke production
- Lime production
- Sinter production
- Cogeneration facility
- Ironmaking in Blast Furnace
- Steelmaking: in Basic Oxygen Furnace (BOF) and EAF
- Rolling mills

In the integrated iron and steel production facility, the main raw materials - national iron ores and limestone as well as imported coal -, were transported to the premises and were stored in silos.

METALLURGICAL COKE PRODUCTION

Metallurgical Coke was produced in the coke plant by destructive distillation of imported coal in coke ovens, where coal was subjected to heat in an oxygen-free atmosphere until all volatile components in the coal evaporate. Process heat came from the combustion of gases between the coke chambers. The material remaining was called coke. Metallurgical coke was then used in the blast furnace to reduce iron ore to iron. Tar and coke oven gas were by-products of metallurgical coke production. Coke oven gas was partly recirculated to be used as fuel in the coke ovens. The remaining coke oven gas was used as fuel as well, in other units of the integrated iron and steel production facility.



According to the 2006 IPCC Guidelines, metallurgical coke production is considered to be an energy use of fossil fuel, hence emissions are addressed and reported under category 1.A.1.c – Manufacture of solid fuels - section 3.3.3 of the Energy chapter. Similarly, all fuel consumed in this source category not allocated as input to the sinter plants and blast furnace is considered fuel combustion and addressed in category 1.A.1.c.

Fugitive emissions from coke production may result from coal preparation, coal charging, oven leakage during the coking period, coke removal and hot coke quenching. Leaks may also occur from poorly sealed doors, charge lids, off take caps, collecting main and from cracks that may develop in oven brickwork (USEPA, 2000). CH₄ fugitive emissions from coke production in the coke plant are estimated and reported under category 1.B.1.b – Solid fuel transformation - section 3.8.2 of the Energy chapter.

LIME PRODUCTION

In iron and steel production, lime is used in the production of sinter, in the production of liquid steel in blast furnace charging and EAF mixtures, for slag formation and to promote steel desulphurization and dephosphorization. There are no emissions from lime use in these kilns. However, production of lime from limestone results in CO₂ emissions from decarbonizing.

From 1990-2001, the integrated iron and steel facility produced lime as a non-marketed intermediate product, to consume internally in its kilns. Those emissions are reported in category 2.A.2 and addressed in chapter 4.2.4 - Lime Production in Iron and Steel. In 2002, one company carried out an extensive investment program to autonomize the lime kiln of the industrial structure and automate the operation, restarting operations as an independent dedicated lime production facility. Lime production emissions from this company are reported in category 2.A.2 and addressed in chapter 4.2.3 - Lime Production in Dedicated Plants.

Note: The other facility has always purchased lime from national lime dedicated plants. Lime production emissions are reported in category 2.A.2 and addressed in section 4.2.3 - Lime Production in Dedicated Plants.

SINTER PRODUCTION

In the sinter production unit, the fines of the iron ores sieved together with other iron bearing materials such as pyrite ash or iron scrap, the lime and the coke breeze, were mixed in the correct proportion and heated under vacuum. High temperatures lead to the melting of iron ore particles, which caused the materials to agglomerate in order to obtain a product called sinter which had excellent reducibility qualities to be sent to the blast furnace.

Part of the coke oven gas produced onsite in the coke plant was used as fuel in the sinter plant.

Operation of the sinter production unit produced CO₂ emissions from oxidation of the coke breeze and other inputs. These emissions are reported and addressed in this chapter. Off gas from sinter production also contained CH₄, NMVOC and other hydrocarbons.

Emissions from combustion process in the sintering unit (namely NO_x, SO_x and CO) are reported under category 1.A.2.a – Manufacture Industries and construction.

COGENERATION UNIT

This unit generated electricity for consumption at the integrated iron and steel production facility. The fuels used were the following:

- Total tar quantity produced onsite in the coke plant;
- Part of the coke oven gas produced onsite in the coke plant;
- Part of the blast furnace gas produced onsite in the blast furnace;
- Fuel oil.



Operation of the cogeneration unit produced combustion emissions which are reported under category 1.A.2.a – Manufacture Industries and construction.

IRONMAKING IN BLAST FURNACE

In the ironmaking facility, coke, lime and sinter were added to the blast furnace, where iron oxides and coke and fluxes reacted with blast air to form molten reduced iron (pig iron), carbon monoxide and slag. Emissions occurred during casting and in the blast furnace top.

Carbon served a dual purpose in the ironmaking process, primarily as a reducing agent to convert iron oxides to iron, but also as an energy source to provide heat when carbon and oxygen react exothermically. According to the 2006 IPCC Guidelines, all carbon used in blast furnaces should be considered process-related IPPU emissions.

In order to achieve a higher combustion temperature, the ironmaking facility included 3 cowpers, discontinuous type heat exchangers where a stack of refractory was alternately heated by the gas from the combustion of blast furnace gas and cooled by the circulation of the insufflated air, thus transferring energy accumulated in it during the heating period. In this way, the gas resulting from process in the blast furnace - blast furnace gas -, with a high CO content, was partly recirculated to be used as fuel in the blast furnace. The remaining blast furnace gas was used as fuel as well in the cogeneration unit. Part of the coke oven gas produced onsite in the coke plant was also used as fuel in the blast furnace.

Emissions from combustion process in the blast furnace (namely NO_x, SO_x and CO) are reported under category 1.A.2.a – Manufacture Industries and construction. CO₂ process emissions resulting from casting operations and seal leaks at top of the furnace are addressed and reported in this chapter.

Pig iron resulting from the blast furnace and scrap were then transformed into steel in subsequent furnaces, namely in a Basic Oxygen Furnace and in an Electric Arc Furnace.

STEELMAKING IN BASIC OXYGEN FURNACE (BOF) AND EAF

In the Basic Oxygen Furnace, molten pig iron from the blast furnace and steel scrap were melted with the injection of a substantial source of oxygen and oxidized part of the carbon associated with iron to produce steel. This carbon was emitted mostly as CO (contributing nevertheless to ultimate CO₂ emissions). Other emissions from BOF were iron oxides, oxides of other metals, sulphur and particulate matter.

Regarding EAF, although located in the integrated iron and steel plant, it consisted of a stand-alone operation because of its fundamental reliance on scrap as a raw material instead of iron. In the EAF, pig iron and steel scrap are subjected to an electric discharge through carbon (graphite) electrodes that reduces its carbon content to produce steel.

Since the EAF process is mainly one of melting scrap and not reducing oxides, carbon's role is not as dominant as it is in the blast furnace/BOF process. In the EAF, CO₂ emissions are mainly associated with carbon additives such as graphite electrodes, anthracite and coke consumption. According to the 2006 IPCC Guidelines, all carbon used in EAFs and other steelmaking processes should be considered process-related IPPU emissions.

Next, the adjustment of the molten steel is carried out in a separate oven, known as a pot oven. In this oven, the homogenization of steel is promoted as well as the introduction of additions and metallic alloys, to adjust its composition.

After adjustment, molten steel from the pot oven is shaped into ingots or billets.

**ROLLING MILLS**

In some cases, ingots or billets are reheated in a kiln and processed in rolling mills, in order to be reshaped into long-product rolling like wire rod and rebar in straight lengths.

Emissions from this finishing process are mostly particulate matter besides combustion pollutants. Combustion emissions from this process are reported in category 1.A.2.a - Manufacture Industries and construction.

--

Ultimate fossil CO₂ emissions are the result of the oxidation of carbon in coke, anodes and electrodes. Part of the carbon is sequestered in the final product – billets - and is not emitted to atmosphere as CO₂. Emissions of carbon may occur as CO and NMVOC but it is assumed that they are subsequently converted in atmosphere in CO₂. The methodology used to estimate NMVOC and CO emissions can be checked in the Portugal IIR. Indirect CO₂ emissions related to NMVOC and CO emissions are reported in CRF Table 6.

Some carbon may remain in pig iron after initial reducing in blast furnace and part may be emitted from oxidation in the BOF. EAF operations also result in carbon emission but mostly from consumption of graphite anodes in the process.

Around 2001, Portuguese economy entered a recession period that culminated with the dismantling of the integrated iron and steel production facility. From 2002 onwards, only the EAF process remained in operation in this facility.

The other plant has a similar steelmaking process through an EAF. From 2002 onwards, there is only secondary steel production through EAF in Portugal.

The table below indicates all emission streams for iron and steel operations and provides information on the categories under which these emissions are reported. However, although combustion emissions and process emissions are estimated separately, they are in fact emitted at same place and are inseparable in concept.

Table 4-37: Emission streams for iron and steel industry

Process/Activity description	Reporting period	GHG coverage	Emission stream	CRF Code Report	NIR Section
Coke production	1990-2001	CO ₂ , CH ₄ , N ₂ O	Combustion	1A1c	3.3.3
		CH ₄	Fugitive emissions	1B1b	3.8.2
Lime production	1990-2001	CO ₂	Process	2A2	4.2.4
Sinter production	1990-2001	CO ₂ , CH ₄	Process	2C1d	4.4.2
Cogeneration	1990-2001	CO ₂ , CH ₄ , N ₂ O	Combustion	1A2a	3.4
Ironmaking	1990-2001	CO ₂	Process	2C1b	4.4.2
Steelmaking: BOF	1990-2001	CO ₂	Process	2C1a	4.4.2
Steelmaking: EAF	1990-onwards	CO ₂	Process	2C1a	4.4.2
Rolling mills, pot ovens and reheating ovens	1990-onwards	CO ₂ , CH ₄ , N ₂ O	Combustion	1A2a	3.4
Other machinery operation (a)	1990-onwards	CO ₂ , CH ₄ , N ₂ O	Combustion	1A2gvii	3.4
(a) Consumption of fuels in other iron and steel related activities such as blowtorches, emergency generators, lift trucks operation, etc.					(b)



4.4.2.2 Methodology

Since there are different processes and different data sources available depending on the years, distinguished methodologies were used throughout the time series.

From 1990-2001, process emissions from the integrated iron and steel production facility were estimated according to two different approaches – product approach and carbon balance.

SINTER PRODUCTION

Operation of sinter plants produces CO₂ emissions from oxidation of the coke breeze and other inputs. Off gas from sinter production also contains methane and other hydrocarbons. CO₂ and CH₄ emissions from sinter production were estimated according to a product approach, as shown in the following equation:

Equation 4-39: Emissions from sinter production

$$E_{mi} = SI \times EF$$

Where:

E_{mi}: CO₂ / CH₄ emissions (t)

SI: Sinter produced (t)

EF: CO₂ / CH₄ emission factor (t/t_{sinter})

Emissions from sintering are reported in source code 2.C.1.d – Metal Industry (sinter).

IRONMAKING IN BLAST FURNACE AND STEELMAKING IN BOF

CO₂ emissions from pig iron production in the blast furnace, as well as from steel production in BOF were estimated according to a carbon balance approach, described in the following equation:

Equation 4-40: Emissions from iron and steel (BOF) production

$$E_{mi} = [\sum (FC_i \times EF_i)] - [\sum (PP_j \times EF_j)]$$

Where:

E_{mi}: CO₂ emissions (t)

FC_i: Annual consumption of feedstock i (t)

EF_i: CO₂ emission factor of feedstock i (t/t_{feedstock i})

PP_j: Annual production of product j (t)

EF_j: CO₂ emission factor of product j (t/t_{product j})

Emissions from ironmaking are reported in source code 2.C.1.b – Metal Industry (pig iron).

Although 2006 IPCC Guidelines provide a Tier 1 methodology for estimating CH₄ emissions from pig iron production, they do not provide a corresponding emission factor. Furthermore, although 1995 IPCC Guidelines provide a Tier 1 methodology and CH₄ emission factor for estimating emissions from pig iron production, it is not appropriate to use because CO₂ emissions were estimated using the Tier 2 mass balance methodology above mentioned. The mass balance methodology makes a basic assumption that all carbon that enters the pig iron production process either exits the process as part of a carbon-containing output or as CO₂ emissions. CH₄ emissions estimation is precluded.

According to the 2006 IPCC Guidelines, CH₄ may be emitted from steelmaking processes as well, however those emissions are assumed to be negligible, hence are reported as Not Estimated (NE).



Emissions from steelmaking in BOF are reported in source code 2.C.1.a – Metal Industry (steel).

STEELMAKING IN EAF

From 2002 onwards, CO₂ emissions from steel production in EAF are estimated according to a carbon balance approach, already described above. From 2005 onwards, when European Union Emissions Trading System (EU ETS) was set up, all Iron and Steel plants are required to prepare carbon balances as part of the monitoring reports.

From 1990-2001, CO₂ emissions from steel production in EAF were estimated according to the following equation:

Equation 4-41: Emissions from steel production (EAF) – 1990-2001

$$Emi = ST \times EF_{(2002-2006)}$$

Where:

Emi: CO₂ / CH₄ emissions (t)

ST: Steel produced (t)

EF: Average CO₂ implied emission factor in 2002-2006 period (t/t_{steel})

As already mentioned, CH₄ emissions are assumed to be negligible, hence are reported as Not Estimated (NE).

Emissions from steelmaking in EAF are reported in source code 2.C.1.a – Metal Industry (steel).

OTHER OPERATIONS AND EMISSIONS RELATED TO IRON AND STEEL SECTOR

Emissions related with Rolling mills, pot ovens and reheating ovens are reported under category 1.A.2.a.

Emissions from lime production are addressed in chapters 4.2.3. and 4.2.4.

Methodology for estimating NO_x, CO, NMVOC and SO₂ emissions is provided in IIR.

4.4.2.3 Emission Factors

Emission factors for Iron and Steel Production in the period 1990-2001 are provided in the table below.

Table 4-38: Emission Factors for Iron and Steel Production in the period 1990-2001

Pollutant	Sinter	Ironmaking	Steel making (BOF)	Steelmaking (EAF)	Unit
CO ₂	0.20 (a)	0.71-1.32 (b)	0.12-0.14 (b)	0.84 (c)	t/t
CH ₄	0.07 (a)	-	-	-	kg/t
NO _x	558 (d)	8 (d)	10 (e)	130 (e)	g/t
CO	18 000 (d)	27 (d)	3500 (e)	1700 (e)	g/t
NMVOC	138 (e)	NE (e)	NE (e)	46 (e)	g/t
SO ₂	463 (d)	38 (d)	NE (e)	60 (e)	g/t

(a) 2006 IPCC Guidelines, Vol. 3, Tables 4.1 and 4.2

(b) Implied emission factor (IEF) obtained from carbon balance approach

(c) Average IEF from 2002-2006

(d) EMEP/EEA guidebook 2019, Vol. 1.A.2, Tables 3-7, 3-8

(e) EMEP/EEA guidebook 2019, Vol. 2.C.1, Tables 3-14, 3-15

From 2002 onwards, CO₂ emission factors for EAF operation used for the two iron and steel plants were determined from consumption of carbon bearing materials in those units. It was assumed that the same carbon content exists in both scrap and final steel produced in EAF furnaces and, consequently, no additional emissions are estimated apart from carbon in additives. The CO₂ stoichiometric emission factors from carbon bearing materials are listed in the table below.



From 2005 onwards, carbon content of raw materials and emission factors are obtained from the EU-ETS for the two facilities.

Table 4-39: Carbon bearing materials: carbon content and CO₂ stoichiometric EF

Material	C Content (t C/t material)	EF (t CO ₂ /t material)
Scrap Iron	0.040	0.147
Steel Scrap	0.010	0.037
Purchased Pig Iron	0.047	0.172
Hot Briquetted Iron (HBI)	0.020	0.073
EAF Carbon Electrodes	0.820	3.007
EAF Coal	0.890	3.263
Coke	0.830	3.043
Petroleum Coke	0.870	3.190
Limestone (CaCO ₃)	0.121	0.444
Dolomite (MgCO ₃ .MgCO ₃)	0.130	0.477
Steel (Billets)	0.010	0.037

From 2016 onwards, EU-ETS iron and steel operators were required to perform carbon content monitoring in scrap iron materials. The emission factors obtained in the monitoring were far lower than the default value that was being applied from 1990 to 2015, which lead to a major decrease in CO₂ emissions from iron and steel. However, given that we find there is not enough reliable EU-ETS monitoring data in order to establish a consistent time series, we decided, for the time being, to maintain the default emission factor for scrap iron for the whole time series, for each facility.

4.4.2.4 Activity Data

Concerning the integrated iron and steel production facility, there are differences in the activity data used in estimates for the period 1990-2001 and from 2002 onwards.

Activity data for emissions estimates related to the integrated iron and steel production facility for the period 1990-2001 comprehend coke consumption, sinter, pig iron and steel production and also scrap consumption. The following sources of information were used to establish activity data time series:

- Annual coke production was obtained from DGEG (Coke plant Balance) from 1990 to 2001. From 2002 onwards, there is no coke production in the iron and steel industry in Portugal;
- Annual production of sinter and pig iron were obtained directly from the facility from 1991 to 1994. For 1990 and from 1995 to 2001, pig iron production was obtained from Worldsteel Association. For 1990 and from 1995 to 2001, sinter production was estimated using pig iron production as surrogate data, given that all sinter produced was consumed in the blast furnace to produce pig iron. Therefore, for the missing years, sinter production was estimated according to the following equation:

Equation 4-42: Sinter production in the integrated iron and steel facility

$$SI_y = PI_y \times \frac{SI_{1991-1994}}{PI_{1991-1994}}$$

Where:

SI_y: Sinter production in year y (t)

PI_y: Pig iron production in year y (t)

SI₁₉₉₁₋₁₉₉₄: Average Sinter production in period 1991-1994 (t)

PI₁₉₉₁₋₁₉₉₄: Average Pig iron production in period 1991-1994 (t)



- From 2002 onwards there is no sinter and pig iron production;
- Annual total steel production from BOF as well as from EAF were obtained from Worldsteel Association from 1990 to 2001, although some years were corrected with existing national data. From 1990 to 2001, annual steel production from EAF for the integrated facility was estimated based on the following equation:

Equation 4-43: EAF steel production in the integrated iron and steel facility – 1990-2001

$$ST_{EAF\ IN\ I\&S} = ST_{EAF\ IN\ WSA} - ST_{EAF\ IN\ OF}$$

Where:

$ST_{EAF\ IN\ I\&S}$: Annual steel production from EAF for the integrated facility (t)

$ST_{EAF\ IN\ WSA}$: Annual total steel production from EAF from Worldsteel Association (t)

$ST_{EAF\ IN\ OF}$: Annual steel production from EAF for the other facility (t) (detail addressed further ahead)

- From 2002 onwards there is no steel production resulting from BOF;
- Annual scrap consumption was obtained directly from the facility from 1990 to 1994. From 1995 to 2001, scrap consumption was estimated using steel production as surrogate data.

Production of total steel and intermediate products in the integrated iron and steel facility is presented in the figure below for the period 1990-2001. As an integrated iron and steel facility, the close relationship between intermediate products and steel produced through BOF is notorious, since their production is intrinsically related to the final amount of steel produced. On the other hand, steel produced from EAF is an independent operation, given that the raw material used is scrap and not iron. From 1990 to 2000, steel produced from EAF represents a minor contribution for total steel production. As we approach the end of this period, steel produced from EAF begins to have more relevance, given the recession effects and the fact that scrap is a cheaper raw material.

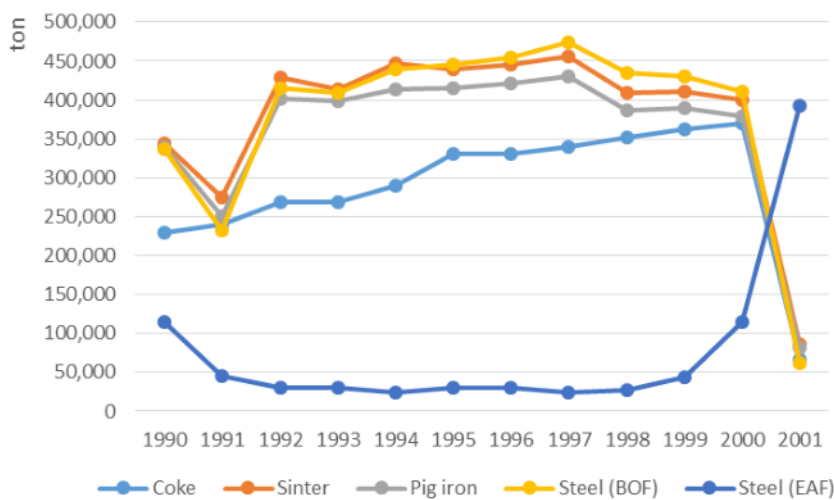

Figure 4-34: Integrated iron and steel facility – production of steel and intermediate products (1990-2001)

Activity data for estimation of CO₂ emissions from iron and steel production from 2002 onwards comprehends fuel consumption (natural gas, gasoil and propane), raw materials consumption. The emissions related to the fuel consumption are reported in source code 1.A.2.a.



From 2002 to 2005:

- Annual steel production from EAF was estimated based on Equation 4-43;
- Annual scrap and pig iron consumption were estimated using steel production as surrogate data.

Concerning the other facility, annual steel production from EAF as well as annual scrap and pig iron consumption from 1990 to 2004 were obtained directly from the facility.

From 2005 onwards, data on consumption of raw materials as well as steel production (as billets) were obtained from EU-ETS for the two facilities.

The figure below presents national steel production by process for the whole time series.

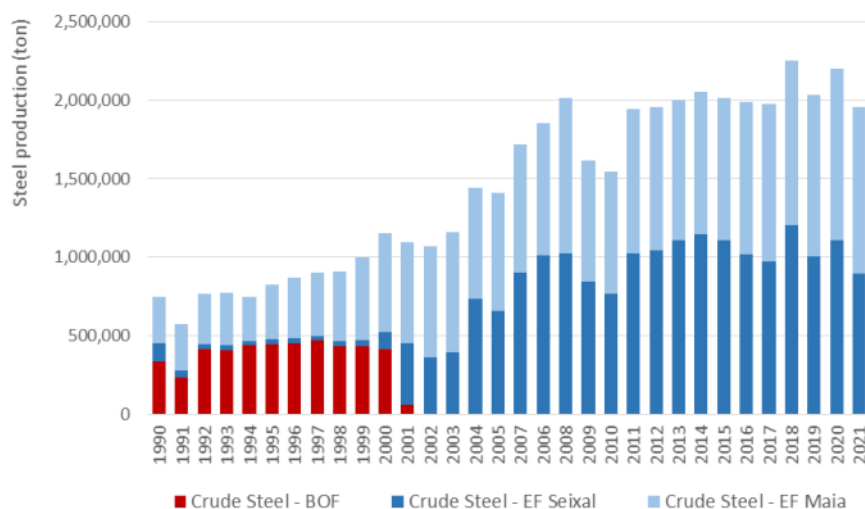

Figure 4-35: Steel production by process

The figure above shows the recession period in the Portuguese economy that culminated in the dismantling of the integrated iron and steel production plant (red), remaining steel production through the EAF (dark blue).

4.4.2.5 Uncertainty Assessment

Uncertainty assessment was based on Chapter 4.2.3 of Volume 4: Metal Industry Emissions of the 2006 IPCC Guidelines for National Greenhouse Gas Inventories.

Table 4-40: Uncertainty values related to emissions reported under CRF 2.C.1

Parameter	Uncertainty	
Activity Data	Sinter production	10%
	Ironmaking	10%
	Steelmaking	10%
CO ₂ EF	Sinter production	25%
	Ironmaking	10%
	Steelmaking	10%
CH ₄ EF	Sinter production	25%

4.4.2.6 Category specific QA/QC and verification

QA/QC procedures included a series of checks: calculation formulas verification, data and parameters verification and the information provided in this report.



Emissions estimates were based on a bottom-up approach with collection of plant specific crude steel production data. A comparison was made using a top-down approach based on crude steel production data obtained from the WorldSteel Association. There are slight differences using the two different approaches but, generally, data is consistent.

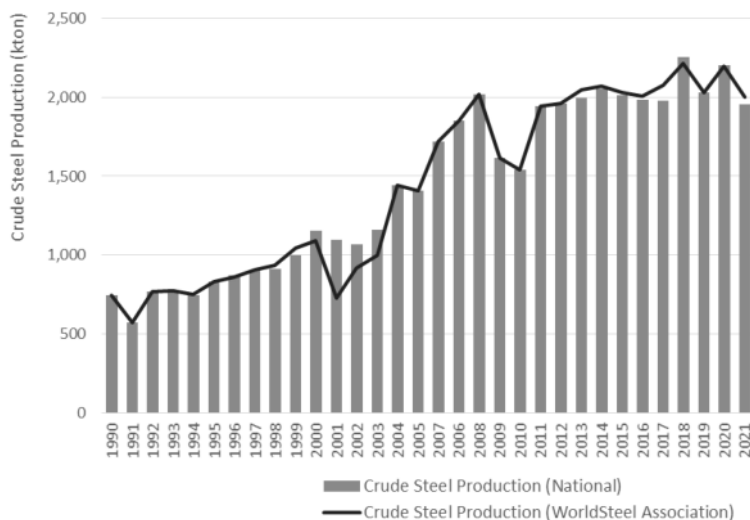

Figure 4-36: Crude steel production in Portugal – comparison of approaches

Data received from the two plants is also cross-checked with data obtained from the energy balance. Part of the differences (fuel consumption data in the national energy balance and in the EU ETS) is considered under source “1.A.2.a”. The differences related to other fuels are reported under source “1.A.2.g.i”, since this could be a misallocation from the energy balance.

4.4.2.7 Recalculations

No recalculations were made.

4.4.2.8 Further Improvements

In the future, we intend to gather information regarding carbon content in raw materials and in steel produced, in order to obtain a more accurate and consistent time series of activity data and CO₂ emissions.

4.4.3 Ferroalloys Production (CRF 2.C.2)

Concerning ferroalloys production, following a 2018 UNFCCC In-Country Review recommendation, a EUROSTAT Sold Production Database research showed production data for ferroalloys in Portugal, specifically “Production of ferro-cerium, pyrophoric alloys, articles of combustibles, n.e.c. (in kg)”, however, there are too many missing years in order to create a consistent time series.

In order to assess the relevance of emissions resulting from the above mentioned activity data, rough conservative CO₂ and CH₄ estimates were made. Available activity data (from 2011-2014, 2017-2021) was obtained from national statistics and EUROSTAT. Tier 1 emission factors were applied according to 2006 IPCC Guidelines (Tables 4.5 and 4.7 of chapter “4 - Metal Industry Emissions” Volume 3).

These estimates were found to be well below the threshold of significance (below 0.002%).

Therefore, and given the scarcity of the activity data in order to assess a timeline, we will report 2.C.2 as Not Estimated.



4.4.4 Aluminium Production (CRF 2.C.3)

Aluminium production will result in CO₂ emissions when it is reduced using carbon electrodes in smelting pots and ultimate CO₂ emissions are the result of consumption of electrodes. This situation occurs when aluminium is manufactured from bauxite ore, using the Soderberg process, for example.

In Portugal, according to information received from the General Directorate of Economic Activities (DGAE), aluminium is produced from ingots and not from bauxite ore. Consequently emissions of CO₂ for this source sector were removed from emission inventory.

4.4.5 Magnesium Production (CRF 2.C.4)

There is no Magnesium Production in Portugal.

4.4.6 Lead Production (CRF 2.C.5)

4.4.6.1 Category description

This chapter addresses emissions CO₂ estimates from the production of lead. There is only secondary Lead production in Portugal.

4.4.6.2 Methodology

CO₂ Emissions from lead production were estimated in accordance with:

Equation 4-44: CO₂ emissions from lead production

$$\text{Emi CO}_2 = \text{EF} \times \text{Lead Production} \times 10^{-3}$$

Where:

Emi CO₂: CO₂ Emissions (kt)

EF: CO₂ emission factor (t CO₂/t Lead)

Lead Production: Lead Production (t Lead)

4.4.6.3 Emission Factors

Table 4-41: CO₂ emission factor related to Lead production

Pollutant	Unit	EF	Source
CO ₂	t CO ₂ /t Lead	0.52	Table 4.21 of Chapter 4: Metal Industry Emissions of 2006 IPCC Guidelines

4.4.6.4 Activity Data

There is only secondary Lead production in Portugal.

In the period 1990-1991, data has been estimated based on 1992 production and on GDP trend.

In the period 1992-2005 and in 2017, data on secondary Lead production was obtained from INE.

Due to lack of information in INE and EUROSTAT, in the period 2006-2007 data has been estimated based on the interpolation of 2005 and 2008 production data.

In the period 2008-2015, data on secondary Lead production was obtained from EUROSTAT.

In 2016, data has been estimated based on 2015 production and on GDP trend.



Due to confidentiality constraints data is presented as an index value related to 1990 production.

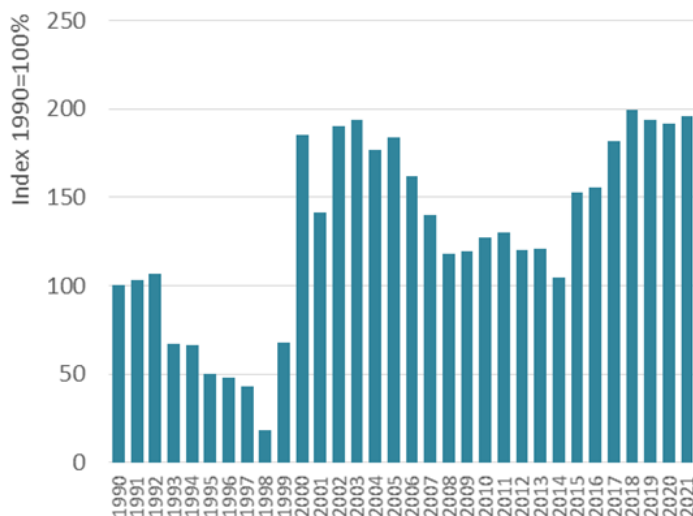

Figure 4-37: Secondary Lead production data (Index 1990=100%)

4.4.6.5 Uncertainty Assessment

Table 4-42: Uncertainty values

Parameter	Type of Uncertainty	Uncertainty	Source
Activity Data	Lead national production data	10%	Table 4.23 of Chapter 4: Metal Industry Emissions of 2006 IPCC Guidelines for National Greenhouse Gas Inventories.
CO ₂ EF	Default Emission Factor	50%	

4.4.6.6 Category specific QA/QC and verification

QA/QC procedures included a series of checks: calculation formulas verification, data and parameters verification and the information provided in this report.

4.4.6.7 Recalculations

2020 activity data was updated.

4.4.6.8 Further Improvements

In order to improve time series consistency, Portugal intends to contact national statistics to obtain secondary lead production for the whole time series and prevent using several sources of AD.

4.4.7 Zinc Production (CRF 2.C.6)

According to INE, there is no Zinc Production in Portugal.

4.4.8 Copper Production (CRF 2.C.7.a)

There are no direct CO₂, CH₄ and N₂O emissions to report in this subsector in Portugal. There are, however, SO_x emissions. The methodology used to estimate SO_x emissions from this category can be checked in Portugal IIR. SO_x emissions from copper production are reported in CRF Table2(l)s1.



4.5 Non-energy Products from Fuels and Solvents Use (CRF 2.D)

4.5.1 Overview

This chapter addresses the estimates of process-related GHG emissions that result from the first use of fossil fuels as a product for primary purposes other than combustion for energy purposes and use as feedstock or reducing agent. Emissions from these exceptions are accounted for in chemical industry (chapter 4.3) and in metal industry (chapter 4.4). The products covered in this chapter comprise lubricants, paraffin waxes, bitumen/asphalt and solvents.

CO₂ emissions reported in CRF Table 2(I)s1 in categories 2.D.3.a - Solvent use and 2.D.3.b - Road paving with asphalt refer to indirect CO₂ emissions. This report was agreed among EU countries with the aim of ensure consistency between KP commitment periods (CP). Countries, like Portugal, reported indirect CO₂ emissions from these categories in inventory submissions before 2015 (CP 1) in previous CRF table 3 (Sectoral report for solvents and other products use). Hence, for the following commitment period and in order to ensure the highest consistency with 2006 IPCC Guidelines and with the previous inventory submissions, countries should continue reporting these emissions in the same manner. Therefore, Portugal continues to report NMVOC emissions from these categories as indirect CO₂ emissions in CRF Table 2(I).A-Hs1, for KP consistency purposes. On that matter, the paper *“Guidance related to the reporting of indirect emissions”* from EEA SHAREPOINT is presented in **ANNEX I** and includes further explanation to the approaches taken by Portugal and all other EU MS.

According to the 2006 IPCC Guidelines, CH₄ emissions from the activities covered in this chapter are expected to be minor or not to occur at all. Although some CH₄ emissions occur from asphalt production and use for road paving, no method to estimate CH₄ emissions is provided by the guidelines, since these emissions are expected to be negligible.

4.5.2 Lubricants Use (CRF 2.D.1)

4.5.2.1 Category description

Lubricants are produced either at refineries through separation from crude oil or at petrochemical facilities. In Portugal, they are used in several sectors, however the most relevant uses are road transportation, transforming industries, agriculture and services.

4.5.2.2 Methodology

Lubricants accounted for in this category can be estimated according to the following:

Equation 4-45: Lubricants accounted for in this category

$$\text{Lubricants}_{\text{Cons}} = \text{Lubricants}_{\text{Cons}} (\text{Total}) - \text{Lubricants}_{\text{Cons}} (\text{Road Transport combustion})$$

Where:

Lubricants_{Cons}: Consumption of Lubricants except in two-stroke engines in Road Transportation (GJ)

Lubricants_{Cons} (Total): Total Consumption of Lubricants (GJ)

Lubricants_{Cons} (Road Transport combustion): Consumption of Lubricants used as energy in two-stroke engines in Road Transportation (GJ)

Lubricant consumption related with combustion that contributes to exhaust emission in Road Transport includes lubricant consumed as energy in two-stroke engines. These emissions are included in Road Transportation (CRF 1.A.3.b) chapter.

CO₂ emissions related to lubricants consumption (reported under CRF 2.D.1) were estimated according to:



Equation 4-46: CO₂ emissions from lubricants consumption

$$\text{CO}_2 \text{ Emissions} = \text{Lubricants}_{\text{Cons}} (2\text{D1}) \times (\text{DCC} \times 44/12 \times 10^{-3}) \times \text{ODU}$$

Where:

CO₂ Emissions: CO₂ emissions (t)

Lubricants_{Cons}(2D1): Consumption of Lubricants except in two-stroke engines in Road Transportation (GJ)

DCC: Default Carbon Content (= 20 kg C/GJ)

ODU: Oxidized During Use factor (dimensionless)

Emissions from 2D1 also include CO₂ emission from lubricants that enter accidentally in the four-stroke engines combustion chambers in road transportation. The methodology used for this estimations is described in Road Transportation (1.A.3.b) chapter.

4.5.2.3 Emission Factors

Both default carbon content and oxidized during used factor were obtained from 2006 IPCC Guidelines (Chapter 5.2.2.2 of IPPU Volume).

Table 4-43: Emission factors for Lubricant Use (2.D.1)

Parameter	Unit	Value	Source
Default Carbon Content	Kg C/GJ	20	2006 IPCC Guidelines
Oxidized During Use Factor	adimensional	0.2	2006 IPCC Guidelines (Table 5.2)

4.5.2.4 Activity Data

The amounts of lubricants used in Portugal were obtained from the national Energy Balance, provided by DGEG.

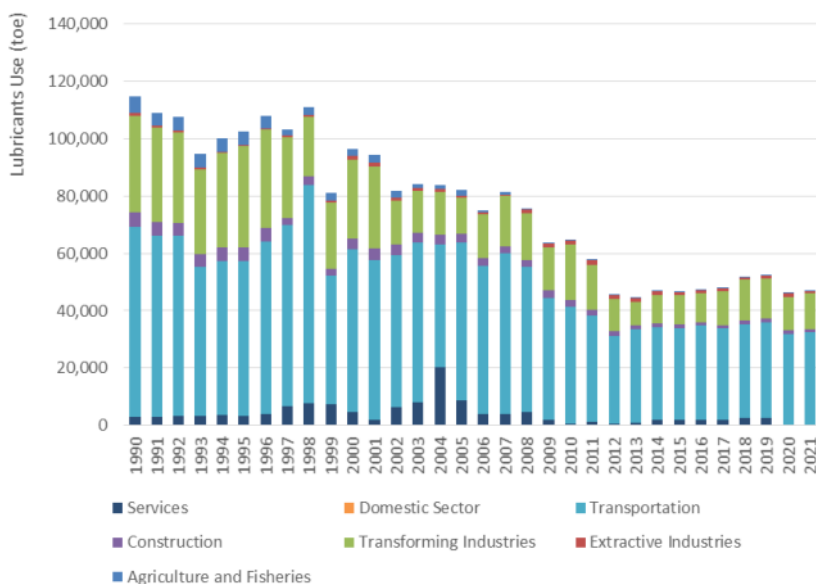

Figure 4-38: Amount of Lubricants used in Portugal



4.5.2.5 Uncertainty Assessment

Table 4-44: Uncertainty values

Parameter	Uncertainty	Source
Activity Data	5.0%	"Well-developed energy statistics" in "subchapter 5.2.3.2" of "Volume 3: Industrial Processes and Product Use" of "2006 IPCC Guidelines for National Greenhouse Gas Inventories".
CO ₂ EF – ODU Factor	50.0%	Subchapter 5.2.3.1 of "Volume 3: Industrial Processes and Product Use" of "2006 IPCC Guidelines for National Greenhouse Gas Inventories".
CO ₂ EF – Carbon Content	3.0%	Subchapter 5.2.3.1 of "Volume 3: Industrial Processes and Product Use" of "2006 IPCC Guidelines for National Greenhouse Gas Inventories".
CO ₂ EF – Combined	50.1%	-

4.5.2.6 Category specific QA/QC and verification

QA/QC procedures included a series of checks: calculation formulas verification, data and parameters verification and the information provided in this report.

4.5.2.7 Recalculations

Two-stroke engines lubricants consumption data were updated for the period 1994 to 2020.

4.5.2.8 Further Improvements

No further improvements are expected.

4.5.3 Paraffin Wax Use (CRF 2.D.2)

4.5.3.1 Category description

Paraffin waxes are separated from crude oil during the production of light lubricating oils and are used in applications such as: candles, corrugated boxes, paper coating, board sizing, food production, wax polishes and surfactants. In Portugal, the most relevant sectors where paraffin waxes are used are chemical/plastics industry, wood products, rubber industry, metalworking industry and paper industry.

4.5.3.2 Methodology

CO₂ emissions are estimated based on:

Equation 4-47: CO₂ emissions from paraffin wax consumption

$$\text{CO}_2 \text{ Emissions} = \text{PW} \times (\text{CC}_{\text{Wax}} \times 44/12 \times 10^{-3}) \times \text{ODU}_{\text{Wax}}$$

Where:

CO₂ Emissions: CO₂ emissions (t)

PW: Consumption of Paraffin Waxes (GJ)

CC_{Wax}: Paraffin Waxes Default Carbon Content (= 20 kg C/GJ)

ODU_{Wax}: Paraffin Waxes Oxidized During Use factor)



4.5.3.3 Emission Factors

Both default carbon content and oxidized during used factor were obtained from 2006 IPCC Guidelines (Chapter 5.3.2.2 of IPPU Volume).

Table 4-45: Emission factors for Paraffin Waxes Use

Parameter	Unit	Value	Source
Default Carbon Content	Kg C/GJ	20	2006 IPCC Guidelines
Oxidized During Use Factor	adimensional	0.2	2006 IPCC Guidelines

4.5.3.4 Activity Data

The amounts of paraffin waxes used in Portugal were obtained from the national Energy Balance provided by DGEG.

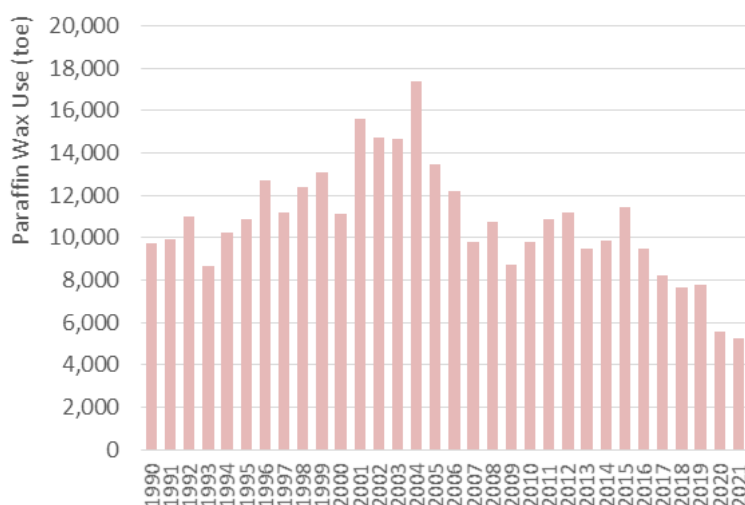

Figure 4-39: Amount of Paraffin Wax used in Portugal

4.5.3.5 Uncertainty Assessment

Table 4-46: Uncertainty values

Parameter	Uncertainty	Source
Activity Data	5.0%	"Well-developed energy statistics" in "subchapter 5.3.3.2" of "Volume 3: Industrial Processes and Product Use" of "2006 IPCC Guidelines for National Greenhouse Gas Inventories".
CO2 EF – ODU Factor	100.0%	Subchapter 5.3.3.1 of "Volume 3: Industrial Processes and Product Use" of "2006 IPCC Guidelines for National Greenhouse Gas Inventories".
CO2 EF – Carbon Content	5.0%	Subchapter 5.3.3.1 of "Volume 3: Industrial Processes and Product Use" of "2006 IPCC Guidelines for National Greenhouse Gas Inventories".
CO2 EF – Combined	100.1%	-

4.5.3.6 Category specific QA/QC and verification

QA/QC procedures included a series of checks: calculation formulas verification, data and parameters verification and the information provided in this report.

4.5.3.7 Recalculations

No recalculations were made.

4.5.3.8 Further Improvements

No further improvements are expected.



4.5.4 Solvent Use – Solvent Use (CRF 2.D.3.a)

There are no direct CO₂, CH₄ and N₂O emissions from solvent use. There are, however, indirect CO₂ emissions related to NMVOC emissions. The methodology used to estimate NMVOC emissions can be checked in the Portugal IIR. Indirect CO₂ emissions related to NMVOC emissions from solvent use are reported in CRF Table2(I).A-Hs2, under 2.D.3. This report was agreed among EU countries with the aim of ensure consistency between KP commitment periods(CP). Countries, like Portugal, reported indirect CO₂ emissions from this category in inventory submissions before 2015 (CP 1) in previous CRF table 3 (Sectoral report for solvents and other products use). Hence, for the following commitment period and in order to ensure the highest consistency with 2006 IPCC Guidelines and with the previous inventory submissions, countries should continue reporting these emissions in the same manner. Therefore, Portugal continues to report NMVOC emissions from solvent use as indirect CO₂ emissions in CRF Table2(I).A-Hs2, for KP consistency purposes.

On that matter, the paper *“Guidance related to the reporting of indirect emissions”* from EEA SHAREPOINT is presented in **ANNEX I** and includes further explanation to the approaches taken by Portugal and all other EU MS.

4.5.5 Solvent Use – Road Paving with Asphalt and Asphalt Blowing in Refineries (CRF 2.D.3.b)

4.5.5.1 Category description

Emission estimates reported in this source category include emissions occurring from paving road surfaces with asphalt materials as well as emissions occurring during operation of hot mix asphalt plants. Emissions from cold asphalt mixtures are not included in the inventory estimates, being assumed that they are negligible.

Road paving with asphalt is done by the application of several layers over road bed. In volume, the majority of pavement is composed of layers of a compact aggregate and an asphalt binder (asphalt concrete). Asphalt concretes are classified either as hot mix or as cold mixes: cutback and emulsified asphalts. Liquefied asphalts – cutbacks and emulsions - are also used directly in seal and priming roadbed operations, sometimes in intermediate layers between applications of asphalt cement layers.

Aggregate materials incorporated in asphalt concrete are usually composed of coarse unconsolidated rock fragments, either obtained from rock crushing, natural alluvial deposits or by products from metal ore refining.

Hot mix asphalts are made by mixing the aggregate material together with the asphalt cement using high temperatures (150^o-160^o)⁹. Cold mix plants also involve mixing aggregate materials with an asphalt binder, but now the binder is an asphalt emulsion or is cutback cement, and this process takes place at much lower temperature (40-60 Celsius degrees).

Asphalt emulsions are mixtures of asphalt cement with water and emulsifiers¹⁰. Cure may result from water evaporation alone or from the formation of chemical ionic bonds between aggregate materials (anionic and cationic emulsions). Asphalt cut-backs are asphalt cements fluidized by mixture with petroleum distillates: heavy fuel oil (Slow Cure), Kerosene (Medium Cure) or Gasoline/naphtha (Rapid Cure).

⁹ That are needed to fluidize the asphalt cement.

¹⁰ And also a solvent in several emulsion types.



Emissions from application of pavement are mostly composed of NMVOC and certain toxic substances as PAH. Cutback asphalts result in the highest emissions due to the evaporation of part of the diluents containing VOC. Emulsified asphalts may also result in NMVOC emissions if they contain solvents in their composition – and they may contain up to 12 % of solvents. Hot mix asphalts in the other hand, result in minimum NMVOC emissions during application, because the organic component has high molecular weight and low vapour pressure (USEPA, 2001 – EIP Volume III Chapter 17).

Asphalt pavements dominate road paving activity in Portugal, whereas rigid cement pavements are only about 5 % of total paved areas (APORBET).

According to the 2006 IPCC Guidelines, direct greenhouse gas emissions, e.g., CO₂ or CH₄, associated with the production and use of asphalt are negligible since the majority of the light hydrocarbon compounds were extracted during the refining process to produce commercial fuels.

Emissions during fabrication of asphalt concretes consist mainly in NMVOC and particulate matter that escape mostly from the drier. The methodology used to estimate these emissions can be checked in the Portugal IIR. Indirect CO₂ emissions related to NMVOC emissions from road paving with asphalt are reported in CRF Table2(I).A-Hs2. Other pollutants are also emitted but they result mostly from combustion of fuels and are considered in the Energy chapter (1.A.2)¹¹.

It was still not possible to distinguish the part of asphalt materials that is used in road pavement and other uses, such as building isolation or asphalt roofing, and therefore all emissions from production of asphalts – except emissions from fuel combustion – are included in this source category.

Emissions related to asphalt blowing were estimated based on the amount of asphalt produced in the asphalt blowing units of each refinery. There are no direct CO₂, CH₄ and N₂O emissions from asphalt blowing. There are, however, NMVOC emissions. The methodology used to estimate NMVOC emissions can be checked in the Portugal IIR. Indirect CO₂ emissions related to NMVOC emissions from this sub-category are reported in CRF Table2(I).A-Hs2.

4.5.6 Solvent Use – Urea based catalytic converters (CRF 2.D.3.c)

The use of urea-based additives in catalytic converters in road transportation generates CO₂ emissions. The methodology used for estimating direct CO₂ emissions from this category is described in Road Transportation (1.A.3.b) chapter, in the Energy sector.

¹¹ To avoid double counting and because from statistical information is not possible to separate fuel use in this particular activity sector.



4.6 Electronics Industry (CRF 2.E)

4.6.1 Overview

This chapter is intended to estimate fluorinated compounds emissions that result from the electronics manufacturing processes. Emissions from this category sector include CF₄, C₂F₆, C₃F₈, c-C₄F₈, c-C₄F₈O, C₄F₆, C₅F₈, CHF₃, CH₂F₂, nitrogen trifluoride (NF₃), and sulfur hexafluoride (SF₆).

4.6.2 Integrated Circuit or Semiconductor (CRF 2.E.1)

Concerning Integrated Circuit or Semiconductor production, upon contact with our Focal Point, we acknowledged a national company which provides wafer-level fan-out (WLFO) semiconductor packaging solutions.

During the 2022 UNFCCC Review, Portugal clarified that this company was only a packaging and assembling facility, regarding semiconductor encapsulation, which did not lead to F-gases emissions. However, upon further contact after the review, we learned this company consumes very small amounts CF₄ in silicon wafer etching processes since 2012.

Upon further research, we learned that a Portuguese university laboratory consumes since 2011 SF₆, CF₄ and C₃F₈ in plasma etching silicon containing materials, in Transmission Electron Microscopes and cleaning chemical vapour deposition (CVD) tool chamber-walls where silicon has deposited.

In order to assess the relevance of emissions resulting from the above mentioned activity data, conservative CO₂ eq estimates were made following the guidance from section 6.2.1.1, chapter 6, Volume 3 of the 2006 IPCC Guidelines. Activity data (average annual consumption of each fluorinated compound from 2011 to 2021) was obtained from both facilities. Default Tier 2a emission factors for FC emissions from semiconductor manufacturing were applied according to 2006 IPCC Guidelines (Tables 6.2 and 6.6 of chapter 6 – Electronics Industry Emissions, Volume 3).

These estimates were found to be well below the threshold of significance (below 0.002%).

Therefore, we report 2.E.1 as Not Occurring from 1995 to 2010 and as Not Estimated from 2011 onwards.

4.6.3 TFT Flat Panel Display (CFR 2.E.2)

Concerning TFT Flat Panel Display production, we have contacted our Focal Point which informed us that are unaware of any TFT flat-panel displays production in Portugal.

After the 2022 UNFCCC Review and upon further investigation, we have also contacted the Portuguese Association of Companies in the Electrical and Electronic Sector, which informed us there never was TFT flat-panel displays production in Portugal. There is only TFT imports.

Therefore, we report 2.E.2 as Not Occurring for the whole time series.



4.6.4 Photovoltaics (CRF 2.E.3)

Concerning photovoltaics production, during the 2022 UNFCCC Review, the Party clarified that a joint-venture facility concerning photovoltaic cell production and distribution was planned to open but it became insolvent before it was fully developed.

Portugal also reported that a solar panel production facility was in operation in the country since 2008 and closed in 2018 due to strong competition from Chinese companies in the renewable energy market. During the 2022 UNFCCC Review, Portugal clarified the annual capacity production of the facility above mentioned - around 90,000 mono and polycrystalline silicon PV modules per year (Source: Thomas Fischer, Publication "Sun&Wind Energy", 7/2009), which corresponds to an area of 270,000 m² of cells, assuming average dimensions of large PV modules. Adopting a conservative approach and based on default data from the 2006 IPCC Guidelines using the PV-cells EFs from table 6.2, the total emissions per operating year were estimated in the order of 10.6 kt CO₂ eq. The level of emissions is below 0.05 per cent of national total emissions so these emissions can be considered as insignificant.

However, upon further contact with the solar panel facility after the review, we learned that fluorinated compounds were not used in cell production. Photovoltaic cells were mounted in vacuum.

After the review and upon further contact with the Portuguese Association of Renewable Energies (APREN), we learned that another Portuguese facility in the manufacturing and design of photovoltaic modules sector is in operation since 1994. Upon contact with the facility, they informed that photovoltaic cells used to assemble photovoltaic modules are imported, and there is no F-gases consumption.

Therefore, given that photovoltaics activities occur in Portugal but do not result in emissions or removals of F-gases in the country, we report 2.E.3 as Not Applicable for the whole time series.

4.6.5 Heat Transfer Fluid (CRF 2.E.4)

Concerning Heat Transfer Fluid, we have contacted our Focal Point which informed us that are unaware of any Heat Transfer Fluid consumption in Portugal.

After the 2022 UNFCCC Review and upon further investigation, we have also contacted the Portuguese Association of Companies in the Electrical and Electronic Sector (ANIMEE), which informed us there never was Heat Transfer Fluid consumption in Portugal.

Therefore, we report 2.E.4 as Not Occurring for the whole time series.



4.7 Products Uses as substitutes for ODS (CRF 2.F)

4.7.1 Overview

This category intends to estimate emissions that result from the following activities:

- Commercial Refrigeration (CRF 2.F.1.a);
- Domestic Refrigeration (CRF 2.F.1.b);
- Industrial Refrigeration (CRF 2.F.1.c);
- Transport Refrigeration (CRF 2.F.1.d);
- Mobile Air Conditioning (CRF 2.F.1.e);
- Stationary Air Conditioning (CRF 2.F.1.f);
- Foam Blowing (CRF 2.F.2);
- Fire Protection (CRF 2.F.3);
- Metered Dose Inhalers (CRF 2.F.4.a);
- Other Aerosols (CRF 2.F.4.b).

As shown in the figure below, there is a strong increase in emissions from product uses as substitutes for ODS (circa 5500 % increase from 1995 to 2021).

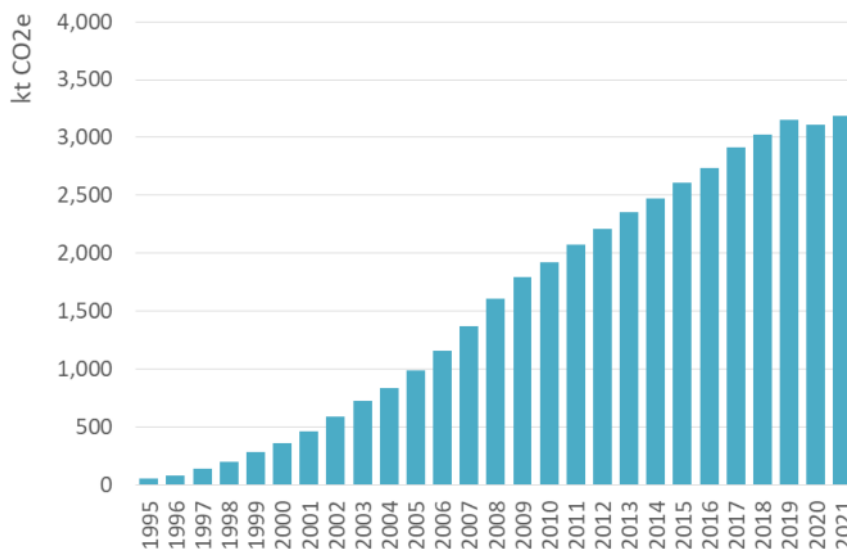

Figure 4-40: Trends in emissions from product uses as substitutes for ODS

In 2021, the most relevant F-gas subcategories were stationary air conditioning (41%), commercial refrigeration (27%) and mobile air conditioning (18%).

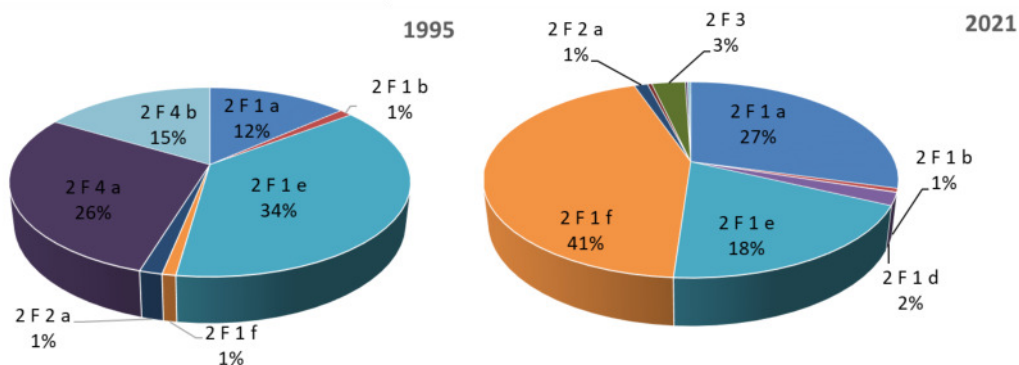

Figure 4-41: Share of emissions by subcategory



Regulation (EC) No 842/2006 proposed obligatory reporting of the use of fluorinated gases. In Portugal, since 2013 there is a national reporting tool (<https://formularios.apambiente.pt/GasesF/>) where about 10,000 national operators report the use of fluorinated greenhouse gases. Until 2014, all operators were obliged to report on the national reporting tool.

In 2014, Regulation (EU) No. 517/2014 (“F-gas Regulation”) regarding F-gases entered into force and required a stepwise reduction of the F-gases placed on the EU market (expressed in CO₂ equivalents) from 1 January 2015 onwards (the so-called HFC phase down). This reduction scheme has triggered technical innovation and the market introduction of numerous alternatives which mostly contain lower shares of HFCs and have lower GWPs than the conventional HFCs used in different applications. The F-gas Regulation also includes a number of bans on the use of F-gases in new products and equipment, where less harmful alternatives are widely available, and F-gas use restrictions. According to this new Regulation, in the first phase, from 01/01/2015 to 31/12/2016, only those operators that fulfilled one of the following two requirements - load equal to or greater than 5 ton and fluid amounts equal to or greater than 3 kg - were required to report in the national reporting tool. More recently, from 01/01/2017 onwards, only those operators that fulfilled the first requirement were required to report in the national reporting tool.

Therefore, from 2014 onwards, information from the national reporting tool is used in the national inventory, but only to establish the share of each gas/blend for each type of equipment. Also, this analysis will assess the status of the implementation of policies for the replacement of fluorinated gases with a high global warming potential by less potent ones or by natural fluids (such as hydrocarbons).

From 2015 onwards, not all national operators report in the national reporting tool, therefore, year 2014 is the more accurate to establish a share of each gas/blend for each type of equipment close to national reality.

The Directive 2006/40/EC (“MAC Directive”) prohibited the use of F-gases with a GWP of over 150 in new passenger cars since 2017. The Directive leads to replacement of HFC-134a as refrigerant in passenger car air conditioning systems by low GWP solutions. HFC-1234yf is the major refrigerant for air conditioning systems in passenger cars and replaced HFC-134a in new vehicles since 2017.

The table below presents overall values of EFs, their data sources, and brief description of data sources of activity data for 2.F sub-categories reported in this inventory.



Table 4.47: Overall parameters applied for 2.F sub-categories reported

CRF Code	Categories	Initial Charge (kg/equip)	Initial Charge Source	Initial Emission (k) - % of Initial Charge/year (1)	Operation Emissions (x) - % of Initial Charge/year (2)	Initial Charge Remaining (p) - % (2)	Recovery Efficiency (nrec,d) - %	Emission Factor Source	IPCC Table
2F1	1. Refrigeration and air conditioning								
2F1 a	Commercial Refrigeration - Stand-alone Commercial Applications	0.87	Manufactures	1.75	0.2	80	60	IPCC 2006 Guidelines	Table 7.9
2F1 a	Commercial Refrigeration - Medium & Large Commercial Applications	var	Survey (4)	1.75	5.5	80	60	IPCC 2006 Guidelines	Table 7.9
2F1 b	Domestic refrigeration - Fridge	0.11	Manufacturers	0.6	0.2	80	60	IPCC 2006 Guidelines	Table 7.9
2F1 b	Domestic refrigeration - Freezer	0.18	Manufacturers	0.6	0.2	80	60	IPCC 2006 Guidelines	Table 7.9
2F1 c	Industrial refrigeration	var	Industrial Companies	1.75	22.5	80	60	IPCC 2006 Guidelines	Table 7.9
2F1 d	Transport refrigeration	5.35	Manufacturers	0.6	32.5	50	60	IPCC 2006 Guidelines	Table 7.9
2F1 e	Mobile air-conditioning - Passengers Cars / Light Duty Vehicles	0.77	Manufacturers	0.35	15	40 (3)	35	IPCC 2006 Guidelines	Table 7.9
2F1 e	Mobile air-conditioning - Heavy Duty Vehicles	1.2	IPCC 2006 Guidelines	0.35	15	40 (3)	35	IPCC 2006 Guidelines	Table 7.9
2F1 e	Mobile air-conditioning - Buses and Coaches	7.5	Manufacturers	0.35	15	40 (3)	35	IPCC 2006 Guidelines	Table 7.9
2F1 e	Mobile air-conditioning - Railways	var	Manufacturers	0.5 (2)	6	40 (3)	35	IPCC 2006 Guidelines	Table 7.9
2F1 f	Stationary air-conditioning - Residential AC	0.3	AC Association	0.6	5.5	75	40	IPCC 2006 Guidelines	Table 7.9
2F1 f	Stationary air-conditioning - Small Chillers	100	AC Association	0.6	5.5	90 (1)	60	IPCC 2006 Guidelines	Table 7.9
2F1 f	Stationary air-conditioning - Medium Chillers	200	AC Association	0.6	5.5	90 (1)	60	IPCC 2006 Guidelines	Table 7.9
2F1 f	Stationary air-conditioning - Large Chillers (Shopping Centers)	441	AC Association	0.6	5.5	90 (1)	60	IPCC 2006 Guidelines	Table 7.9
2F1 f	Stationary air-conditioning - Large Chillers (Other)	600	AC Association	0.6	5.5	90 (1)	60	IPCC 2006 Guidelines	Table 7.9
2F2	2. Foam blowing agents								
2F2 a	Closed cells	F-Gas Consumption in Manufacturing	Manufacturers	10	4.5	-	-	IPCC GP Guidance	Table 3.17
2F2 b	Open cells	F-Gas Consumption in Manufacturing	Manufacturers	100	-	-	-	IPCC GP Guidance	Table 3.17
2F3	3. Fire protection								
2F3	Fire Protection	F-Gas Consumption in Manufacturing	Manufacturers	-	-	100 (7)	0	-	-
2F4	4. Aerosols								
2F4 a	Metered dose inhalers	F-Gas in Pharmaceutical Products	Ass. Pharmaceutical Products	-	100 (6)	-	-	-	-
2F5	5. Solvents								
2F6	6. Other applications								

(1) Average value of the range suggested by the 2006 IPCC Guidelines

(2) Within the range of values proposed by the 2006 IPCC Guidelines (0-70%)

(3) IPCC good Practice Guidance (Table 3.23) Updated default values = 40%

(4) For further information consult Section 4.7.2.3.2 "Activity Data - Operation and Servicing"

(6) It is assumed that the entire HFC contained in the equipment is issued during operation phase

(7) It is assumed that the entire HFC contained in the equipment is issued at the time of disposal



4.7.2 Commercial Refrigeration (CRF 2.F.1.a)

4.7.2.1 Category description

Commercial Refrigeration represented the second largest share of HFC emissions within the Portuguese Refrigeration and Air Conditioning sector in 2021 (27%).

4.7.2.2 Methodology

CFC, HCFC and F-Gases emissions from operation and disposal of Commercial Refrigeration Equipment were estimated using a bottom-up approach Tier 2a.

Emissions when charging new equipment are estimated by the following equation:

Equation 4-48: Emissions when charging new equipment

$$E_{charge(t,y)} = N_t \times m_t \times \frac{HFC_y}{100} \times \frac{k}{100}$$

Where:

$E_{charge(t,y)}$: Emissions of fluid y during system manufacture/assembly in year t (t of fluid)

N_t : Number of equipment charged in year t

m_t : Amount of refrigeration fluid charged into each equipment in year t (t of fluid)

HFC_y : HFC y charged in new equipment (%)

K : Emission factor of assembly losses of the HFC charged into new equipment, per sub-application (%)

Parameter HFC_y refers to the percentage of each Gas/Mixture, regardless of the type of equipment, and can be consulted in Table 4-48.

Emissions during equipment lifetime are estimated by the following equation:

Equation 4-49: Emissions during equipment lifetime

$$E_{lifetime(t,y)} = B_t \times \frac{HFC_y}{100} \times \frac{\chi}{100}$$

Where:

$E_{lifetime(t,y)}$: Emissions of fluid y during system lifetime in year t (t of fluid)

B_t : Amount of fluid banked in existing systems in year t (t of fluid)

HFC_y : HFC y banked in existing equipment (%)

χ : Annual emission rate of HFC of each sub-application bank during operation, accounting for average annual leakage and average annual emissions during servicing (%)



Parameter Bt refers to the total amount of fluid banked in existing systems, regardless of the type of gas/mixture, and is estimated according to the following equation:

$$B_t = n.^{\circ} \text{ Equipment} \times \text{initial charge/equipment} \times 10^{-3}$$

Where:

Bt: Total national amount of fluid banked in equipment (t of fluid)

n.^o equipment: Number of equipment

initial charge/equipment: Amount of fluid charged into each equipment (kg/unit)

Chapter 4.7.2.4.2 *Activity Data – Operation and Servicing* describes the methodology to assess the number and dimension of non-domestic refrigeration equipment used in commerce, industry, tourism, services and institutional activities. Initial charge/equipment (kg/unit) can be consulted in Table 4-45.

Emissions at system end-of-life (Disposal) are estimated by the following equation:

Equation 4-50: Emissions at system end-of-life (Disposal)

$$E_{\text{end-of-life}(t,y)} = B_{t-d} \times \frac{HFC_y}{100} \times \frac{Disp}{100} \times \frac{P}{100} \times \left(1 - \frac{\eta_{rec,d}}{100}\right)$$

Where:

E_{end-of-life (t,y)}: Emissions of fluid y at system disposal in year t (t of fluid)

B_{t-d}: Amount of fluid banked in existing systems in year (t-d) (t)

HFC_y: HFC y banked in existing equipment in year (t-d) (t)

Disp: Annual disposal rate of equipment (%)

P: Residual charge of HFC in equipment being disposed of, expressed in percentage of full charge (%)

H_{rec,d}: Recovery efficiency at disposal (%)

d: Year of charging

4.7.2.3 Emission Factors

4.7.2.3.1 Emission Factors – Assemblage

Table 4-48: Emission Factors considered in assemblage

Description	Unit	Value	Source
First charge (m _t)	kg/unit	0.87	Portuguese manufacturers survey in 2005 (in line with the values proposed in Table 7.9 of the 2006 IPCC Guidelines (0.2-6.0 kg for Stand-alone Commercial Applications))
First charge emissions (k)	%	1.75	Average value taken from Table 7.9 of the 2006 IPCC Guidelines (0.5-3.0 % of initial charge for Medium & Large Commercial Applications)



4.7.2.3.2 Emission Factors – Operation and Servicing

Table 4-49: Emission Factors for F-gas emissions from commercial refrigeration equipment (hypermarkets not included)

Type of Equipment	Charging - kg/unit (1)	Lifetime Emissions - % (2)	Residual Charge of HFC in equipment being disposed (P) -%-(3)	Recovery Efficiency at disposal (ηrec) -%-(4)	Annual disposal rate - %-(5)	Lifetime (6)
Mini-Fridge	0.05	0.20	80	60	8.3	12
Fridge	0.11	0.20	80	60	8.3	12
Horizontal Freezer	0.87	5.50	80	60	8.3	12
Congelation Chamber	1.20	5.50	80	60	8.3	12
Refrigeration Chamber	1.20	5.50	80	60	8.3	12
Supermarket Vertical Freezer Showcase	0.87	5.50	80	60	8.3	12
Vertical Freezer	0.87	5.50	80	60	8.3	12
Under Bench Refrigerator	1.31	5.50	80	60	8.3	12
Supermarket Horizontal Freezer Showcase	1.31	5.50	80	60	8.3	12
Fridge (Bottles)	1.31	5.50	80	60	8.3	12
Wine Fridge Showcase	0.87	5.50	80	60	8.3	12
Ice Machine	0.05	5.50	80	60	8.3	12
Juice Machine	0.05	5.50	80	60	8.3	12
Ice Cream Machine	0.05	5.50	80	60	8.3	12
Chantilly Machine	0.05	5.50	80	60	8.3	12
Tap drink cooler	0.05	5.50	80	60	8.3	12
Can Vendor	0.11	0.20	80	60	8.3	12
Tap beer cooler	0.05	5.50	80	60	8.3	12

(1) Portuguese manufacturers survey in 2005 (in line with the values proposed in Table 7.9 of the 2006 IPCC Guidelines (0.2-6.0 kg of initial charge for Stand-alone Commercial Applications)
 (2) Portuguese manufacturers survey in 2005 (in line with the values proposed in Table 7.9 of the 2006 IPCC Guidelines (1-15 % of initial charge for Stand-alone Commercial Applications)
 (3) In line with the values proposed in Table 7.9 of the 2006 IPCC Guidelines (0-80 % for Stand-alone Commercial Applications)
 (4) In line with the values proposed in Table 7.9 of the 2006 IPCC Guidelines (0-70 % for Stand-alone Commercial Applications)
 (5) Assuming a lifetime of 12 years as stated above, it is assumed that 8.3% (1/12 x 100) of stocks are abated per year, so that at the end of 12 years the stock for a given year has been depleted
 (6) Average value taken from Table 7.9 of the 2006 IPCC Guidelines (10-15 for Stand-alone Commercial Applications)

Table 4-50: Emission Factors for F-gas emissions in hypermarkets

Area (m ²)	Category	Positive Temperature	Negative Temperature	Initial Emission (k	Operation Emissions (x)	p	η (recovery efficiency at disposal)
		Initial Charge (kg) (1)	Initial Charge (kg) (2)	- % of Initial Charge/year (3)	- % of Initial Charge/year (4)	(residual charge at disposal) -% (5)	- % (6)
Area >4500	Big	1800	1250	1.75	22.5	80	60
1000 ≤ Area ≤ 4500	Medium	550	350	1.75	22.5	80	60
Area < 1000	Small	350	250	1.75	22.5	80	60

(1) (2) Portuguese manufacturers survey in 2005
 (3) Average value taken from Table 7.9 of the 2006 IPCC Guidelines (0.5-3.0 % of initial charge for Medium & Large Commercial Applications)
 (4) Average value taken from Table 7.9 of the 2006 IPCC Guidelines (10-35 % of initial charge for Medium & Large Commercial Applications)
 (5) In line with the values proposed in Table 7.9 of the 2006 IPCC Guidelines (0-80 % for Stand-alone Commercial Applications)
 (6) In line with the values proposed in Table 7.9 of the 2006 IPCC Guidelines (0-70 % for Stand-alone Commercial Applications)



4.7.2.4 Activity Data

4.7.2.4.1 Activity Data – Assemblage

Data from 1995 to 2007 was obtained from national statistics Industrial Survey (IAPI) and refers to on the assemblage of commercial and industrial refrigeration units with a viewing monitor. From 2008 onwards, data was estimated based on GDP values. 2020 numbers are slightly lower due to the COVID pandemic.

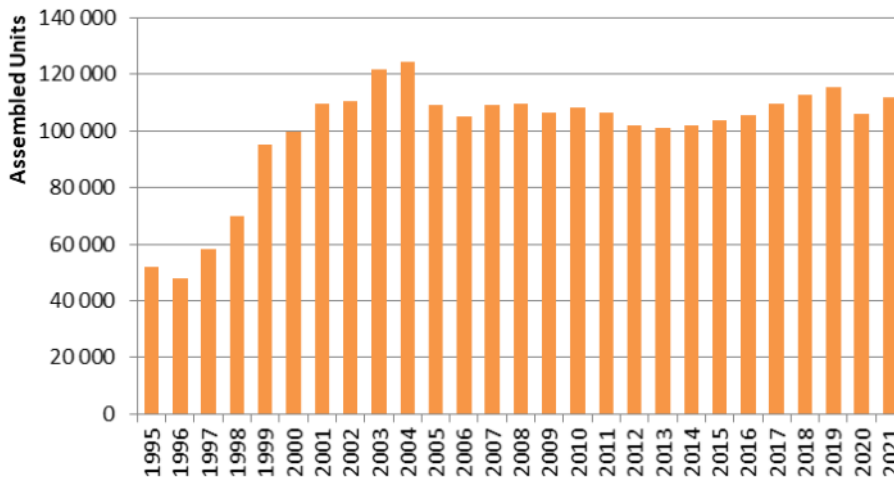

Figure 4-42: Number of commercial refrigeration assembled units in Portugal

The percentage of each Gas/Mixture, regardless of the type of equipment, can be consulted in the table below. The composition and the GWPs of the blends used by the inventory were obtained from the Portuguese Environment Agency and can be consulted in the following link: https://apambiente.pt/sites/default/files/2022-07/BD_FGases_site_07_2022.pdf.

Table 4-51: Use of each Gas/Mixture in the assembled units (%) - HFC_y

% of Fluid	Unit	1995	2005	2019	2020	2021
CFC-12	%	33.6	0.0	0.0	0.0	0.0
HCFC-22	%	66.4	0.0	0.0	0.0	0.0
R-404A	%	0.0	15.2	39.6	39.6	39.6
HFC-134A	%	0.0	84.8	36.2	36.2	36.2
R-407C	%	0.0	0.0	7.9	7.9	7.9
R-410A	%	0.0	0.0	6.2	6.2	6.2
R-422D	%	0.0	0.0	3.9	3.9	3.9
R-417A	%	0.0	0.0	2.5	2.5	2.5
R-422A	%	0.0	0.0	1.9	1.9	1.9
R-507A	%	0.0	0.0	1.8	1.8	1.8

Source:

- . From 1995 to 2004, the sector’s experts association (APIRAC);
- . From 2014 onwards, the F-gas tool;
- . From 2005 to 2013 the information was back casted based on the average of the years 2005 and 2014.

4.7.2.4.2 Activity Data – Operation and Servicing

There are no available national statistics concerning the number and dimension of non-domestic refrigeration equipment used in commerce, industry, tourism, services and institutional activities. A survey to Hotels, Hostels and Camping Parks was conducted with the support of “Turismo de Portugal, I.P.” and “AHP – Associação da Hotelaria de Portugal”, in order to obtain real data concerning the number and dimension of non-domestic refrigeration equipment. Data pertaining to other commerce and services activities was estimated with the technical support of APIRAC, Fluorinated Gases Distributors and DGAE (Economic Activities General Directorate). Calculations for Hypermarkets were made separately.



The number of refrigeration equipment was estimated based on the unit numbers available from INE, for the economic activities indicated in the figure below. 2020 numbers are slightly lower due to the COVID pandemic.

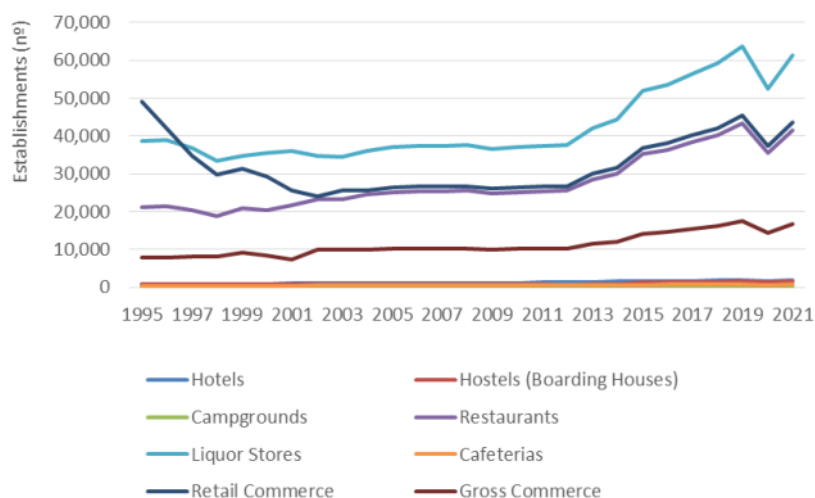

Figure 4-43: Number of commercial establishments by type

The following assumptions were made:

- Retail Commerce and Gross Commerce do not include Hypermarkets (large, medium or small);
- For Hotels, Hostels, Boarding Houses, Other Establishments and Campgrounds, the following data was considered:

Table 4-52: Number of refrigeration equipment per commercial unit in Portugal

Type of refrigeration equipments	Hotels	Hostels and Boarding Houses	Campgrounds
Mini-Fridge	71	14	40
Fridge	5	2	5
Horizontal Freezer	3	2	4
Congelation Chamber	1	1	1
Refrigeration Chamber	3	2	1
Supermarket Vertical Freezer Showcase	2	2	2
Vertical Freezer	1	1	2
Under Bench Refrigerator	4	2	2
Supermarket Horizontal Freezer Showcase	1	1	2
Fridge (Bottles)	1	1	3
Wine Fridge Showcase	1	1	3
Ice Machine	2	1	1
Juice Machine	0	0	1
Ice Cream Machine	0	1	1
Chantilly Machine	0	1	0
Tap drink cooler	1	1	2
Can Vendor	0	1	2
Tap beer cooler	2	1	2

Source: Survey with the support of “Turismo de Portugal, IP” and “AHP – Associação da Hotelaria de Portugal”

When it was not possible to use real data, the number of equipment per activity was set by expert judgement and through visits to some installations, according to the following table:



Table 4-53: Number of refrigeration equipment per commercial unit in Portugal

Type of refrigeration equipment	Equipment			
	Frigerific/Congelation Chamber (unit)	Fridge Showcase (m/unit)	Freezer (unit)	Fridge (unit)
Restaurants	1	4	2	1
Liquor stores	-	4	-	-
Cafeterias	2	4	3	-
Retail Commerce	2	10	-	-
Gross Commerce	2	50	-	-

Source: Expert Judgement based on local survey

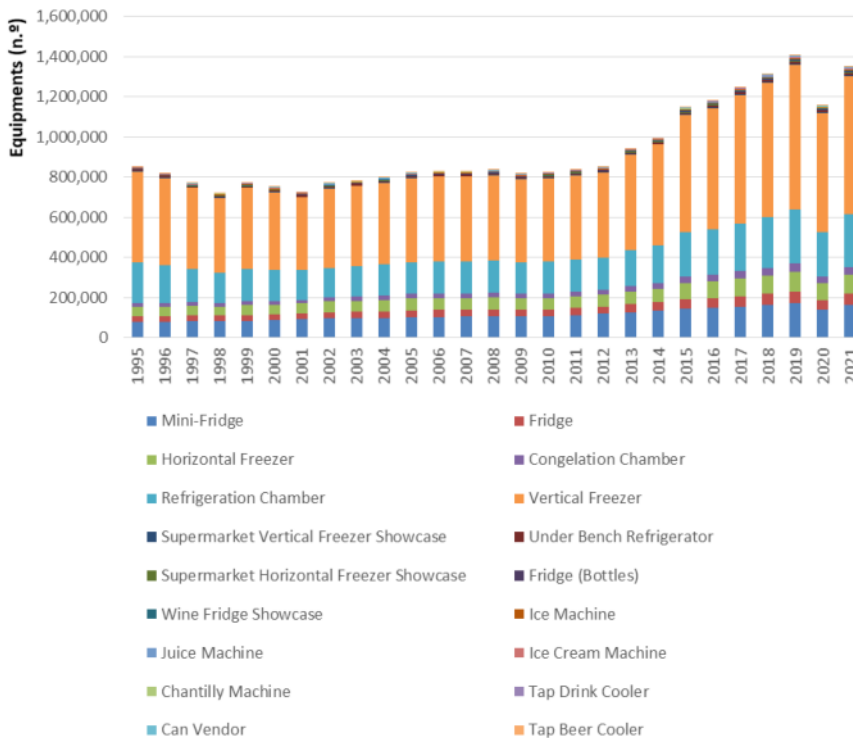

Figure 4-44: Number of commercial refrigeration equipment

2020 numbers are slightly lower due to the COVID pandemic.

For Hypermarkets, calculations were made using data on average numbers of specific equipment (showcase fridges/freezers, frigerific chambers, freezing chambers) for each category (big, medium and small).

Table 4-54: Classification of refrigeration equipment by area

Area (m ²)	Category	Showcase Fridge/Freezer (m)		Refrigeration Chambers (m ²)	Congelation Chambers (m ²)
		Positive Temperature	Negative Temperature		
Area >4500	Big	218	110	550	180
1000 ≤ Area ≤ 4500	Medium	96	48	75	82
Area < 1000	Small	40	38	10	20

Source: Hypermarket Company



The number of disposed equipment in each year was assumed equal to the number of assembled equipment 12 years before. For disposal calculations, it was considered that the F-gas composition equals that of the year when the equipment was assembled, i.e. that of emission year less the lifetime of the equipment¹². It was assumed an average lifetime of 12 years.

4.7.2.5 Uncertainty Assessment

We used a triangular distribution to estimate uncertainty values based on the minimum and maximum of the range proposed by the guidelines and the more probable value (expert judgment).

Table 4-55: Stand-alone commercial units (Hypermarkets equipment not included)

Parameter	Minimum Value	Maximum Value	Selected Value	U(%)
Number of equipment per commercial place	0	391	71.2	112.0%
Initial Charge	0.40	0.46	0.44	2.8%
AD Combined Uncertainty	-	-	-	112.5%
Lifetime	10	15	12	8.5%
Initial Emission	0.5	3	1.75	29.2%
Lifetime Emission	1	15	8	35.7%
Residual charge remaining at disposal	0	80	80	20.4%
Recovery efficiency at disposal	0	70	60	23.8%
EF Combined Uncertainty	-	-	-	56.4%

Table 4-56: Medium & Large commercial units (Hypermarkets equipment)

Parameter	Minimum Value	Maximum Value	Selected Value	U(%)
Number of commercial places	-	-	-	10%
Initial Charge	350	1800	550	53.8%
% HFC	-	-	-	30%
AD Combined Uncertainty	-	-	-	62.4%
Lifetime	10	15	12	8.5%
Initial Emission	0.5	3	1.75	29.2%
Lifetime Emission	10	35	22.5	22.7%
Residual charge remaining at disposal	50	100	80	12.8%
Recovery efficiency at disposal	0	70	60	23.8%
EF Combined Uncertainty	-	-	-	46.6%

4.7.2.6 Category specific QA/QC and verification

QA/QC procedures included a series of checks: calculation formulas verification, data and parameters verification and the information provided in this report.

4.7.2.7 Recalculations

2020 activity data were updated. Also, minor recalculations regarding this sub-sector for the whole time series resulted from the adoption of the latest GWP according to AR5.

4.7.2.8 Further Improvements

We intend to obtain the AD from APED for the period 2011–2014 and present the new emission estimates in the future submissions.

¹² In consequence no emissions of HFC from disposal are estimated for the reported period.



4.7.3 Domestic Refrigeration (CRF 2.F.1.b)

4.7.3.1 Category description

Domestic Refrigeration represented 1% of HFC emissions within the Portuguese Refrigeration and Air Conditioning sector in 2021.

4.7.3.2 Methodology

Regarding domestic refrigeration, we only consider emissions from equipment filled with HFC-134a, given that R-12 is not a GHG (moreover, was already covered by the Montreal Protocol) and CRF tables do not include refrigerant HC-600a.

HFC-134a emissions from Domestic Refrigeration equipment were estimated using a bottom-up approach Tier 2a according to chapter 7.5 of Volume 3 of the 2006 IPCC Guidelines, already described in Commercial Refrigeration (CRF 2.F.1.a). Please check sector 4.7.2.2.

4.7.3.3 Emission Factors

Emission factors and parameters considered for this activity are listed in the table below. The values proposed for domestic refrigeration equipment's initial charge by type are based on national manufacturers and suppliers. Given that there is no national data available regarding the other parameters, 2006 IPCC Guidelines for "Domestic Refrigeration" recommend the use of default emission factors shown in Table 7.9 of chapter 7, Volume 3. The values considered are within the ranges proposed in Table 7.9.

Table 4-57: Emission Factors and parameters of F-gases from Domestic Refrigeration equipment

Description	Unit	Refrigerators	Freezers
Initial Charge (1)	Kg/equipment	0.11	0.18
Initial Emission (k) (2)	%	0.6	0.6
Operation Emission (χ) (3)	%	0.2	0.2
p (initial charge remaining) (4)	%	80	80
η (recovery efficiency at disposal) (5)	%	40	40
Lifetime (6)	years	16	16
(1) Average value based on Portuguese manufacturers survey in 2022 (in line with Table 7.9 of the 2006 IPCC Guidelines) (2) Average value taken from Table 7.9 of the 2006 IPCC Guidelines (0.2-1.0 % of initial charge for Domestic Refrigeration) (3) Average value taken from Table 7.9 of the 2006 IPCC Guidelines (0.1-0.5 % of initial charge for Domestic Refrigeration) (4) In line with the values proposed in Table 7.9 of the 2006 IPCC Guidelines (0-80 % for Domestic Refrigeration) (5) In line with the values proposed in Table 7.9 of the 2006 IPCC Guidelines (0-70 % for Domestic Refrigeration) (6) Average value taken from Table 7.9 of the 2006 IPCC Guidelines (12-20 years for Domestic Refrigeration)			

4.7.3.4 Activity Data

GENERAL ASSUMPTIONS

Regarding domestic refrigeration, we only consider refrigerators and freezers as household refrigeration appliances. The first domestic refrigerators in Portugal date back to the 1950s, and their purchase has become widespread for Portuguese homes since then. In the 1990s and until around 2000, ODS R-12 (GWP of 10,200) was used as refrigerant in domestic fridges and freezers in Portugal.

Following the Montreal Protocol, ODS R-12's phasing-out process led to the globalization of the use of the refrigerant HFC-134a (GWP of 1,300) in new appliances. In the last few years, HFC-134a's phasing-out has already been taking place, due to the EU F-Gas Regulation No. 517/2014.

According to this Regulation, refrigerants exceeding a GWP of 150 are not allowed in new domestic fridges and freezers since 2015. The Regulation does not specify any alternative refrigerant or system, leaving the technical choice to manufacturers. Nevertheless, the domestic refrigeration industry began launching new



equipment using refrigerant R-600a (isobutane), which is why this low GWP (3) hydrocarbon has been adopted globally.

Therefore, we only consider emissions from domestic refrigeration equipment filled with HFC-134a, given that R-12 is not a GHG (moreover, was already covered by the Montreal Protocol) and CRF tables do not include hydrocarbons such as R-600a. We also consider that fluid mixtures/blends are not used in this sector.

ASSEMBLY PHASE

Methodology applied for equipment assembly phase takes into account the number of new equipment assembled in Portugal and the share of refrigeration fluids used. Due to unavailability of national data regarding the penetration of the different refrigeration fluids in new equipment in Portugal, we assumed the following:

- From 1996 onwards, following the Montreal Protocol, no domestic refrigeration equipment assembled in Portugal is filled with ODS R-12;
- From 1996 to 2005, all domestic refrigeration equipment assembled in Portugal were filled with refrigerant HFC-134a;
- From 2015 onwards, following the F-Gas Regulation, all domestic refrigeration equipment assembled in Portugal were filled with refrigerant R-600a;
- According to the refrigeration industry, some equipment brands begun to introduce R-134a and R-600a in new equipment already before the commitment periods established by the legislation (Montreal Protocol and F-Gas Regulation, respectively). However, given there is no available national data on that matter, and assuming that the complete transition to a new refrigerant technology takes place over a 10 year period (according to 2006 IPCC Guidelines), for the time being we assumed a linear transition tendency between the different refrigerant fluids.

The number of assembled domestic refrigeration units (refrigerators and freezers) in Portugal was obtained from the Industrial Production Survey, published by the National Statistics 'Office (INE) from 1992-2011 and from 2018 onwards. Missing years were interpolated based on 1992, 2011 and 2018 existing values. The figure below presents the number of equipment's assembled in Portugal and fluids installed. The significant decrease observed in 2005 in assembled units was due to the closure of a large refrigeration manufacturer in Portugal.

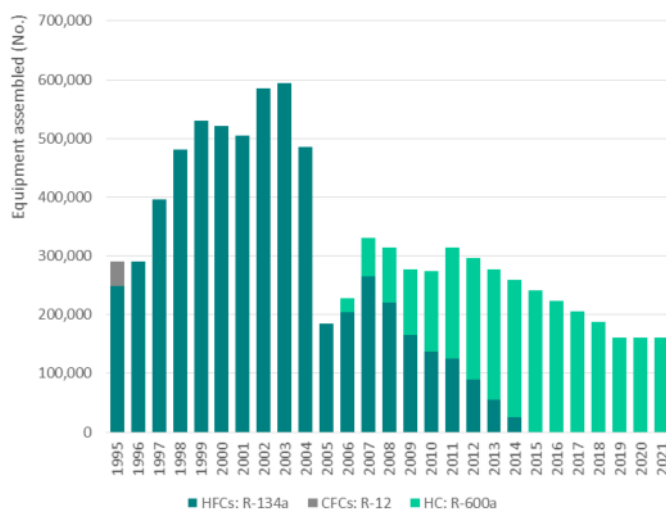

Figure 4-45: Domestic refrigeration equipment assembled in Portugal by type of fluid



4.7.3.4.1 Activity Data– Operation and Servicing

OPERATION PHASE

Methodology applied for equipment operation phase takes into account the number of existing refrigeration appliances in households, assumptions made in relation to fluid introduction in assembly phase, as well as a 16 year lifetime for this equipment. Due to unavailability of national data regarding the penetration of the different refrigeration fluids in existing equipment in Portugal, we assumed the following:

- There was no retrofit of R-12 with R-134a in Portugal. Equipment with R-12 maintained it until the end of its life. All new equipment was already assembled with R-134a;
- There is no retrofit of R-134a with R-600a in Portugal. Equipment with R-134a maintained it until the end of its life. All new equipment was already assembled with R-600a;
- It is possible that R-600a is not the only fluid with GWP <150 in household refrigeration appliances in Portugal, however, we can assume that, for the time being, the existence of fluids with GWP <150 other than R-600a is negligible, according to contacts established with Portuguese manufacturers.

Due to unavailability of national data regarding the number of refrigerators/freezers in operation in Portugal, we considered the percentage of households with refrigeration equipment provided by the *Household Consumption Survey*, published by INE/DGEG in every 10 years. We also considered a common household to be a *classic accommodation as main residence* in Portugal. Total annual classic accommodations as main residence in Portugal were obtained from INE’s annual publication *Construction and Housing Statistics*.

Also, a 16 year lifetime was considered for these equipment, assumption validated with Portuguese manufacturers. Refrigerators/freezers in operation each year were estimated considering the existing stock in the previous year, adding assembled equipment and subtracting abated equipment.

The figure below presents the domestic refrigeration stock in Portugal and fluids installed.

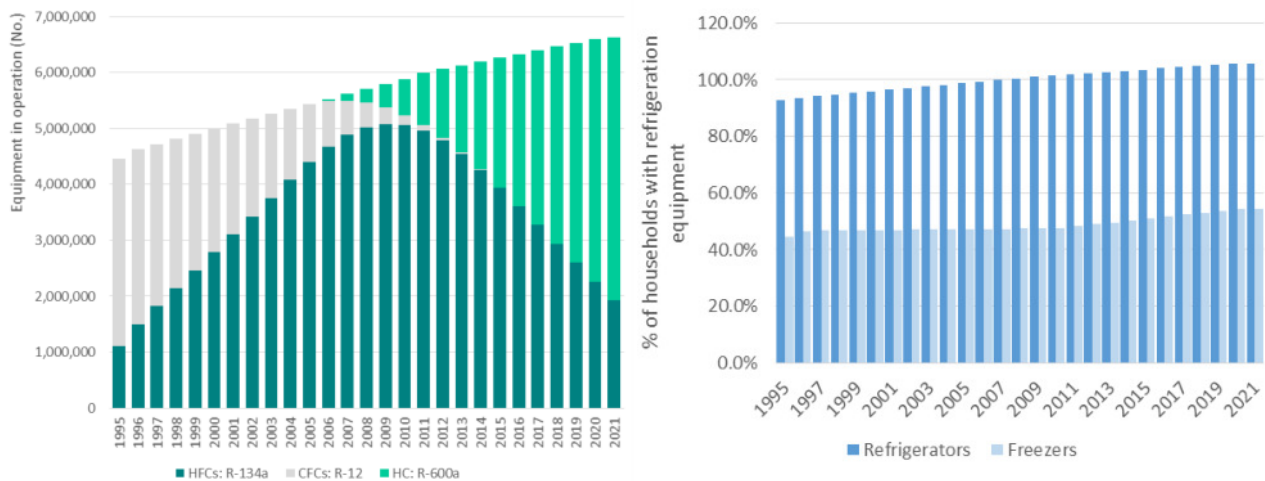

Figure 4-46: Domestic refrigeration equipment in operation in Portugal by type of fluid and share of households with refrigeration equipment



DISPOSAL PHASE

Prohibitions in the use of some HFCs and the phase-down of these compounds only started in the last decade, and therefore little data are available regarding their destruction. Nevertheless, much improvement still needs to be achieved in the recovery and management of F-gases and other refrigerants in Portugal. Despite having legislation that regulates these procedures since around 2006, when waste electrical and electronic equipment (WEEE) management entities were created in Portugal, the country still faces challenges in order to efficiently manage refrigerants, namely:

- . low collection rate of this equipment, most of which continues to be sent to non-certified operators, which are not prepared to collect refrigerant fluids, causing their release to the atmosphere;
- . city councils have great difficulty in combating the theft of economic value domestic refrigeration equipment, such as compressors, which contain the refrigeration fluids;
- . lack of supervision of operators that collect and forward scrap metal for recycling;
- . lack of supervision of operators that crush metal scrap, which are the final destination of most refrigeration equipment diverted from the legal circuit;
- . WEEE management entities face great challenges in creating efficient collection circuits for refrigeration equipment;
- . economic capacity to implement efficient (and sometimes expensive) technologies to improve the collection, recovery, reclaim and destruction of F-gases.

In Portugal, there are no F-gases recovery or destruction facilities; domestic refrigeration equipment is collected and stored in order to be sent abroad (mostly Spain). Emissions of GHGs may occur during the transport of the equipment from the site where they were stored to the recovery/destruction facility and during the destruction process, however, no data is available regarding these issues.

National circumstances over the years have caused an overall growing of the average lifespan of domestic refrigeration equipment. This means that the majority of that equipment currently at end-of-life in Portugal is above 12 years old and is equipped with R-134a fluid. The small (but growing) percentage of end-of-life equipment filled with R-600a is not accounted for in the inventory, for reasons already mentioned.

Upon contact with sectoral authorities, we have learned that illegal dismantling of refrigeration equipment still occurs in Portugal in order to recover metals (mostly compressors, due to its market value) and other material, with no concerns for the potential refrigerant release. However, we have not been able to quantify exactly how much of this illegal activity occurs in Portugal. No national data on initial charge remaining on refrigeration equipment at end-of-life or recovery efficiencies are available, therefore, a default value within the range suggested in Table 7.9 of chapter 7.5.2.2 Volume 3 of the 2006 IPCC Guidelines was used.

There is no available national data regarding the number of disposed refrigerators/freezers in Portugal. Therefore, the number of disposed refrigerators/freezers in Portugal was estimated in parallel with the domestic refrigeration stock estimates, where all equipment purchased annually since 1970 (obtained from INE) is considered, as well as its disposal 16 years later (considering a normal lifetime distribution around 16 years).



The figure below presents the domestic refrigeration at end-of-life in Portugal by type of fluid installed.

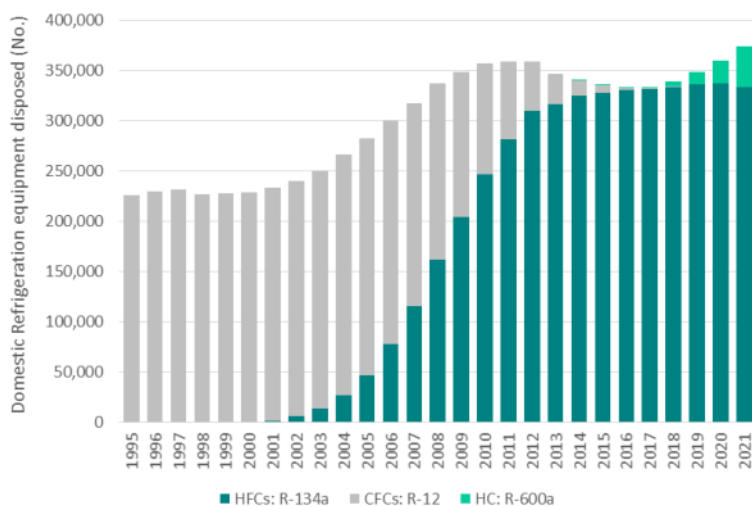

Figure 4-47: Domestic refrigeration equipment disposed in Portugal by type of fluid

4.7.3.5 Uncertainty Assessment

A triangular distribution was used to estimate uncertainty values based on the minimum and maximum of the range proposed by 2006 IPCC Guidelines and the more probable value (expert judgment).

Table 4-58: Domestic Refrigeration – Fridge

Parameter	Minimum Value	Maximum Value	Selected Value	U(%)
Number of equipment	-	-	-	10.0%
Initial Charge	0.10	0.12	0.11	3.8%
% HFC				30.0%
AD Combined Uncertainty	-	-	-	31.8%
Lifetime	12	20	12	13.6%
Initial Emission	0.2	1.0	0.6	27.2%
Lifetime Emission	0.1	0.5	0.2	40.8%
Residual charge remaining at disposal	0	80	80	20.4%
Recovery efficiency at disposal	0	70	60	23.8%
EF Combined Uncertainty	-	-	-	59.8%

Table 4-59: Domestic Refrigeration –Freezers

Parameter	Minimum Value	Maximum Value	Selected Value	U(%)
Number of equipment	-	-	-	10.0%
Initial Charge	0.10	0.26	0.18	18.3%
% HFC				30.0%
AD Combined Uncertainty	-	-	-	36.5%
Lifetime	12	20	12	13.6%
Initial Emission	0.2	1.0	0.6	27.2%
Lifetime Emission	0.1	0.5	0.2	40.8%
Residual charge remaining at disposal	0	80	80	20.4%
Recovery efficiency at disposal	0	70	60	23.8%
EF Combined Uncertainty	-	-	-	59.8%



4.7.3.6 Category specific QA/QC and verification

QA/QC procedures included a series of checks: calculation formulas verification, data and parameters verification and the information provided in this report.

Following a 2022 ESD review recommendation, methodological changes were made to domestic refrigeration's estimates in order to reflect the prohibitions laid down in the Regulation (EU) No 517/2014 in domestic refrigeration equipment in Portugal, and revised estimates were presented and approved by the TERT. However, in order to fully address and update this sector, further investigation after ESD 2022 review led to revised updates and additional assumptions, which led to a new revision of the estimates which are presented in this submission.

4.7.3.7 Recalculations

Following a 2022 ESD review recommendation, methodological changes were made to domestic refrigeration's estimates in order to reflect the prohibitions laid down in the Regulation (EU) No 517/2014 (placing on the market of domestic refrigerators and freezers that contain HFCs with GWP of 150 or more is prohibited since 2015) in domestic refrigeration equipment in Portugal. This legislation had already entered into force in Portugal, however, was not being accounted for in the inventory, due to time and human resources constraints. No emission factors were revised for this submission.

Recalculations occurred are mostly due to activity data update, specifically:

- concerning the revision of the fluids considered in this category. In previous submissions we were considering substances that are not known to be used in domestic refrigeration (even before the placing of the market prohibition of HFCs with GWP of 150 or more in the F-gas Regulation). Upon further research, we learned that HFC-134a was the most common fluid used in domestic refrigeration, which has been progressively replaced by R-600a (isobutene) in recent years;
- concerning the fluid's penetration rate throughout the whole time series, for the 3 emission stages: assembly, operation and disposal. This parameter was updated in order to reflect the market's phasing down of domestic refrigerators and freezers that contain HFCs with GWP of 150 since 2015. As already mentioned, some equipment brands begun to introduce R-134a and R-600a in new equipment already before the commitment periods established by the legislation (Montreal Protocol and F-Gas Regulation, respectively). It was also assumed a 10 year period in order to complete transition to a new refrigerant technology (according to 2006 IPCC Guidelines);
- concerning the revision of the number of domestic refrigeration equipment throughout the whole time series, considered in the 3 emission stages: assembly, operation and disposal. Upon further research, these parameters were revised based on several National Statistics 'Office (INE) publications;
- concerning the lifetime considered for domestic refrigeration equipment used in Portugal. In previous submissions we were considering a 12 year lifetime. Upon further research and contacts with national manufacturers and assemblers, we learned that a 16 year lifetime would be more in line with current national circumstances.

Fluids R-125, R-143a and R-32 are no longer being considered in this category. Recalculations in this category resulted in a significant decrease in emissions for every phase (assembly, operation and disposal) and are presented in the figures below.

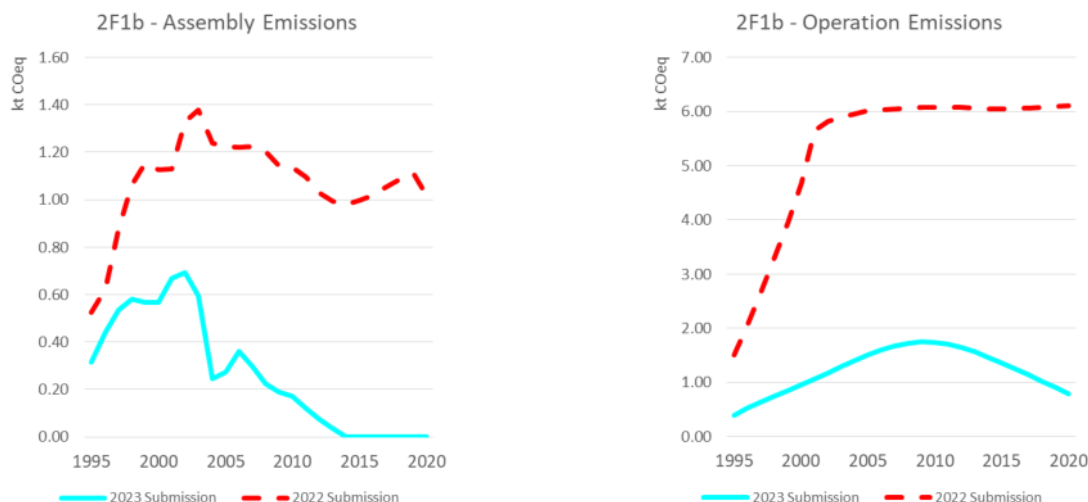

Figure 4-48: Recalculations in Domestic Refrigeration – assembly and operation phase

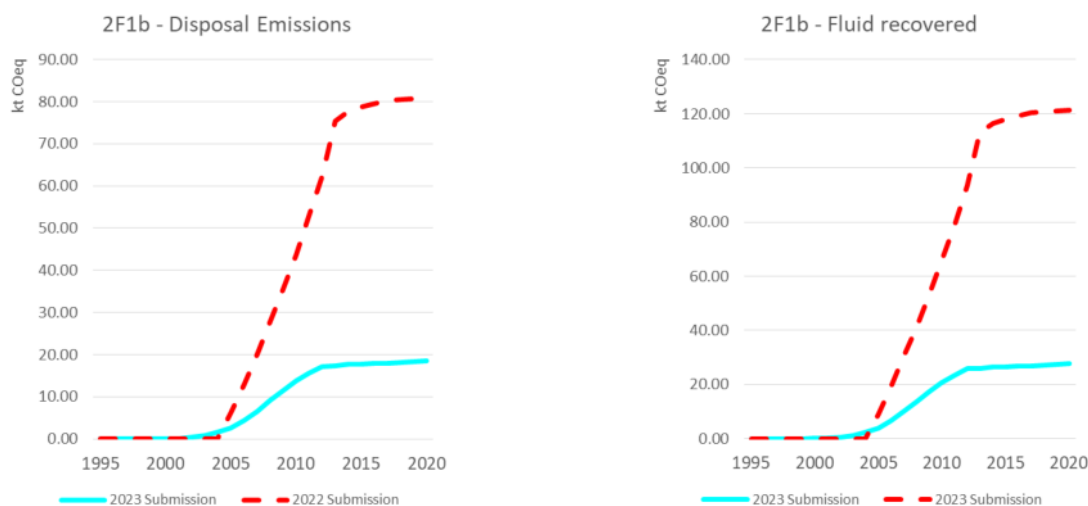

Figure 4-49: Recalculations in Domestic Refrigeration – disposal phase and fluid recovery

Revised estimates to this category taking into account the updates made resulted in overall decrease in emissions. Recalculations occurred in category 2.F.1.b emissions and concerning total category 2.F.1 are presented in the figures below, in ton CO₂eq.

Recalculations concerning category 2.F.1.b emissions represented -65% in 1995 (base year for F-gases), -64% in 2005 and -78% in 2020.

Recalculations concerning category 2.F.1 emissions represented -5% in 1995 (base year for F-gases), -1% in 2005 and -2% in 2020.

Also, minor recalculations regarding this category for the whole time series resulted from the adoption of the latest GWP according to AR5.

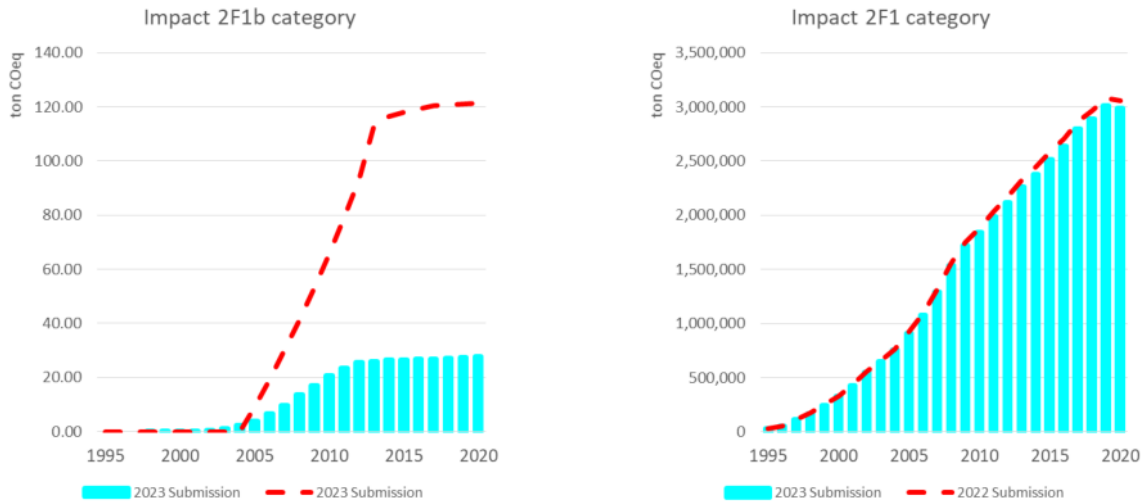

Figure 4-50: Recalculations in Domestic Refrigeration – 2.F.1.b and overall 2.F.1

4.7.3.8 Further Improvements

No further improvements are expected.



4.7.4 Industrial Refrigeration (CRF 2.F.1.c)

4.7.4.1 Category description

Industrial Refrigeration represented less than 1% of HFC emissions within the Portuguese Refrigeration and Air Conditioning sector in 2021.

4.7.4.2 Methodology

Emissions from Industrial Refrigeration equipment were estimated using a bottom-up approach Tier 2a.

Emissions when charging new equipment are estimated by the following equation:

Equation 4-51: Emissions when charging new equipment

$$E_{charge(t,y)} = N_t \times m_t \times \frac{HFC_y}{100} \times \frac{k}{100}$$

Where:

$E_{charge(t,y)}$: Emissions of fluid y during system manufacture/assembly in year t (t of fluid)

N_t : Number of equipment charged in year t

m_t : Amount of refrigeration fluid charged into each equipment in year t (t of fluid)

HFC_y : HFC y charged in new equipment (%)

K : Emission factor of assembly losses of the HFC charged into new equipment, per sub-application (%)

Parameter HFC_y refers to the percentage of each Gas/Mixture, regardless of the type of equipment, can be consulted in Table 4-48.

Emissions during equipment lifetime are estimated by the following equation:

Equation 4-52: Emissions during equipment lifetime

$$E_{lifetime(t,y)} = B_t \times \frac{HFC_y}{100} \times \frac{\chi}{100}$$

Where:

$E_{lifetime(t,y)}$: Emissions of fluid y during system lifetime in year t (t of fluid)

B_t : Amount of fluid banked in existing systems in year t (t of fluid)

HFC_y : HFC y banked in existing equipment (%)

χ : Annual emission rate of HFC of each sub-application bank during operation, accounting for average annual leakage and average annual emissions during servicing (%)

Parameter B_t refers to the total amount of fluid banked in existing systems, regardless of the type of gas/mixture, and is estimated according to the following equation:

$$B_t = n.^{\circ} \text{ Equipment} \times \text{initial charge/equipment} \times 10^{-3}$$

Where:

B_t : Total national amount of fluid banked in equipment (t of fluid)

$n.^{\circ}$ equipment: Number of equipment

initial charge/equipment: Amount of fluid charged into each equipment (kg/unit)



Chapter 4.7.4.4 *Activity Data* describes the methodology to assess the number and dimension of non-domestic refrigeration equipment used in commerce, industry, tourism, services and institutional activities. Initial charge/equipment (kg/unit) can be consulted in Table 4-60.

Emissions at system end-of-life (Disposal) are estimated by the following equation:

Equation 4-53: Emissions at system end-of-life (Disposal)

$$E_{end-of-life(t,y)} = N_{t-d} \times m_{t-d} \times \frac{HFC_y}{100} \times \frac{P}{100} \times \left(1 - \frac{\eta_{rec,d}}{100}\right)$$

Where:

$E_{end-of-life(t,y)}$: Emissions of fluid y at system disposal in year t (t of fluid)

N_{t-d} : Number of equipment charged in year t-d (Nr)

m_{t-d} : Amount of fluid banked in existing systems in year (t-d) (t)

HFC_y : HFC y banked in existing equipment in year (t-d) (t)

Disp: Annual disposal rate of equipment (%)

P: Residual charge of HFC in equipment being disposed of, expressed in percentage of full charge (%)

$\eta_{rec,d}$: Recovery efficiency at disposal (%)

d: Year of charging

4.7.4.3 Emission Factors

The following emission factors and parameters were considered for this activity, usually corresponding to values within the ranges proposed in Table 7.9 of chapter 7 of the 2006 IPCC Guidelines for “Industrial Refrigeration including Food Processing and Cold Storage”. The composition and the GWPs of the blends used by the inventory were obtained from the Portuguese Environment Agency and can be consulted in the following link: https://apambiente.pt/sites/default/files/2022-07/BD_FGases_site_07_2022.pdf.

Table 4-60: Industrial Refrigeration emission factors

Description	Unit	Emission Factor	Source
Initial Emission (k)	%	1.75	Average value taken from Table 7.9 of the 2006 IPCC Guidelines (0.5-3.0 % of initial charge for Industrial Refrigeration)
Lifetime Emission (x)	%	22.5	In line with the values proposed in Table 7.9 of the 2006 IPCC Guidelines (7-25 % of initial charge for Industrial Refrigeration)
Lifetime	Years	12	In line with the values proposed in Table 7.9 of the 2006 IPCC Guidelines (7-15 for Medium & Large Commercial Refrigeration)
p (residual charge at disposal)	%	80	In line with the values proposed in Table 7.9 of the 2006 IPCC Guidelines (50-100 % for Industrial Refrigeration)
η (recovery efficiency at disposal)	%	60	In line with the values proposed in Table 7.9 of the 2006 IPCC Guidelines (0-90 % for Industrial Refrigeration)



4.7.4.5 Activity Data

Activity data was obtained from companies that use industrial refrigeration equipment in their activity. Unavailable data was forecasted by APA based on GDP trend. Due to confidentiality constraints it is not possible to present activity data.

The percentage of each Gas/Mixture, regardless of the type of equipment, can be consulted in the table below. The composition and the GWPs of the blends used by the inventory were obtained from the Portuguese Environment Agency and can be consulted in the following link: https://apambiente.pt/sites/default/files/2022-07/BD_FGases_site_07_2022.pdf.

4.7.4.6 Uncertainty Assessment

We used a triangular distribution to estimate uncertainty values based on the minimum and maximum of the range proposed by the 2006 IPCC Guidelines and the more probable value (expert judgment).

Table 4-61: Industrial Refrigeration

Parameter	Minimum Value	Maximum Value	Selected Value	U(%)
Number of industrial plants	-	-	-	10.0%
Initial Charge	350	1800	550	53.8%
% HFC				30.0%
AD Combined Uncertainty	-	-	-	62.4%
Lifetime	10	15	12	8.5%
Initial Emission	0.5	3	1.75	29.2%
Lifetime Emission	10	35	22.5	22.7%
Residual charge remaining at disposal	50	100	80	12.8%
Recovery efficiency at disposal	0	70	60	23.8%
EF Combined Uncertainty	-	-	-	46.6%

4.7.4.7 Category specific QA/QC and verification

QA/QC procedures included a series of checks: calculation formulas verification, data and parameters verification and the information provided in this report.

4.7.4.8 Recalculations

2020 activity data was updated. Also, minor recalculations regarding this sub-sector for the whole time series resulted from the adoption of the latest GWP according to AR5.

4.7.4.9 Further Improvements

Efforts will be made to collect information from the most relevant industrial refrigeration plants, reported under Regulation (EC) No. 517/2014. This will allow a better characterization of the most relevant fluorinated gases used in this subsector.



4.7.5 Transport Refrigeration (CRF 2.F.1.d)

4.7.5.1 Category description

Transport Refrigeration represented about 2% of HFC emissions within the Portuguese Refrigeration and Air Conditioning sector in 2021.

4.7.5.2 Methodology

Emissions from Transport Refrigeration Equipment were estimated using a bottom-up approach Tier 2a.

Emissions when charging new equipment are estimated by the following equation:

Equation 4-54: Emissions when charging new equipment

$$E_{charge(t,y)} = N_t \times m_t \times \frac{HFC_y}{100} \times \frac{k}{100}$$

Where:

$E_{charge(t,y)}$: Emissions of fluid y during system manufacture/assembly in year t (t of fluid)

N_t : Number of equipment charged in year t (Nr)

m_t : Amount of refrigeration fluid charged into each equipment in year t (t of fluid)

HFC_y : HFC y charged in new equipment (%)

K : Emission factor of assembly losses of the HFC charged into new equipment, per sub-application (%)

Parameter HFC_y refers to the percentage of each Gas/Mixture, regardless of the type of equipment, and can be consulted in Table 4-48.

Emissions during equipment lifetime are estimated by the following equation:

Equation 4-55: Emissions during equipment lifetime

$$E_{lifetime(t,y)} = B_t \times \frac{HFC_y}{100} \times \frac{\chi}{100}$$

Where:

$E_{lifetime(t,y)}$: Emissions of fluid y during system lifetime in year t (t of fluid)

B_t : Amount of fluid banked in existing systems in year t (t of fluid)

HFC_y : HFC y banked in existing equipment (%)

χ : Annual emission rate of HFC of each sub-application bank during operation, accounting for average annual leakage and average annual emissions during servicing (%)

Parameter B_t refers to the total amount of fluid banked in existing systems, regardless of the type of gas/mixture, and is estimated according to the following equation:

$$B_t = n.^{\circ} \text{Equipment} \times \text{initial charge/equipment} \times 10^{-3}$$

Where:

B_t : Total national amount of fluid banked in equipment (t of fluid)

$n.^{\circ}$ equipment: Number of equipment



initial charge/equipment: Amount of fluid charged into each equipment (kg/unit)

Chapter 4.7.5.4.2 *Activity Data – Operation and Servicing* describes the methodology to assess the number and dimension of non-domestic refrigeration equipment used in commerce, industry, tourism, services and institutional activities. Initial charge/equipment (kg/unit) can be consulted in Table 4-62.

Emissions at system end-of-life (Disposal) are estimated by the following equation:

Equation 4-56: Emissions at system end-of-life (Disposal)

$$E_{end-of-life(t,y)} = N_{t-d} \times m_{t-d} \times \frac{HFC_y}{100} \times \frac{P}{100} \times \left(1 - \frac{\eta_{rec,d}}{100}\right)$$

Where:

$E_{end-of-life(t,y)}$: Emissions of fluid y at system disposal in year t (t of fluid)

N_{t-d} : Number of equipment charged in year t-d (Nr)

m_{t-d} : Amount of fluid banked in existing systems in year (t-d) (t)

HFC_y : HFC y banked in existing equipment in year (t-d) (t)

Disp: Annual disposal rate of equipment (%)

P: Residual charge of HFC in equipment being disposed of, expressed in percentage of full charge (%)

$\eta_{rec,d}$: Recovery efficiency at disposal (%)

D: Year of charging

4.7.5.3 Emission Factors

The value for initial charge was assumed to be 5.35 kg/unit (average of the values proposed by national manufacturers and suppliers) which is within the recommended IPCC range (3 to 8 kg/unit). Lifetime was set at 10 years (average of the values proposed by manufacturers and suppliers).

Table 4-62: Transport Refrigeration emission factors

Description	Unit	Emission Factor	Source
Initial Charge	Kg/equipment	5.35	Average value based on Portuguese manufacturers survey in 2005 (in line with the values proposed in Table 7.9 of the 2006 IPCC Guidelines - 3-8 kg for Transport Refrigeration)
Initial Emission (k)	%	0.6	Average value taken from Table 7.9 of the 2006 IPCC Guidelines (0.2-10 % of initial charge for Transport Refrigeration)
Lifetime Emission (x)	%	32.50	Average value taken from Table 7.9 of the 2006 IPCC Guidelines (15-50 % of initial charge for Transport Refrigeration)
Lifetime	Years	10	Average value based on Portuguese manufacturers survey in 2005
p (residual charge at disposal)	%	50.00	In line with the values proposed in Table 7.9 of the 2006 IPCC Guidelines (0-50 % for Transport Refrigeration)
η (recovery efficiency at disposal)	%	60.00	In line with the values proposed in Table 7.9 of the 2006 IPCC Guidelines (0-70 % for Transport Refrigeration)



4.7.5.4 Activity Data

4.7.5.4.1 Activity Data – Assemblage

It was assumed that, before 1996, CFC-12 was used in Portugal as Refrigeration Fluid instead of HFC. From 1996 onwards it is assumed that 50% of the equipment are assembled with HFC-134a and the remaining 50% with R-404A. Data on the number of equipment assembled in Portugal was collected from equipment manufacturers in the period 1996-2010. From 2011 onwards, this number was estimated based on year 2010 value and on GDP trend. 2020 numbers are slightly lower due to the COVID pandemic.

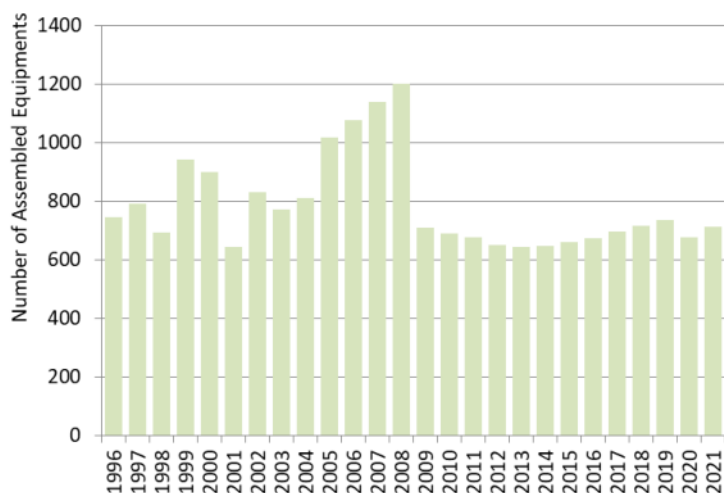

Figure 4-51: Number of equipment assembled in Portugal

4.7.5.4.2 Activity Data – Operation and Servicing

Data on the number of registered vehicles was provided by the Portuguese Authority on Vehicles (ex-DGV) in the period 1996-2005. From 2006 onwards, this value was estimated based on the average number of registered vehicles in the period 2002-2005.

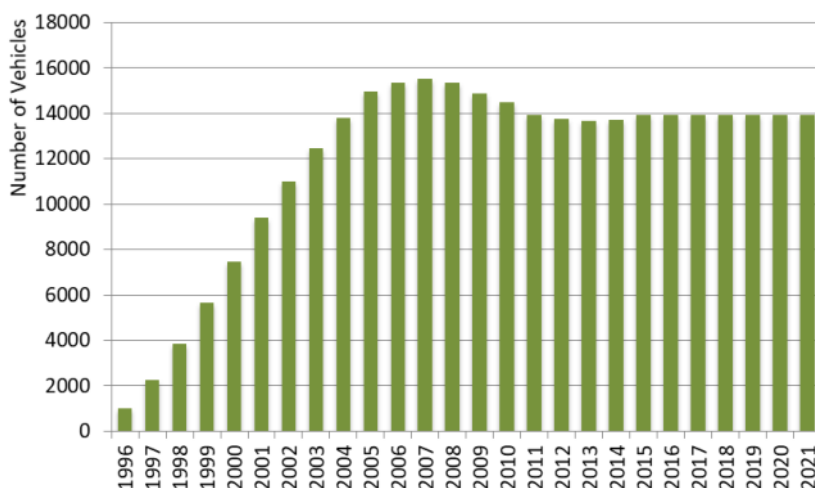

Figure 4-52: Number of registered vehicles in circulation in Portugal using HFC

The percentage of each Gas/Mixture, regardless of the type of equipment, can be consulted in the table below. The composition and the GWPs of the blends used by the inventory were obtained from the Portuguese Environment Agency and can be consulted in the following link: https://apambiente.pt/sites/default/files/2022-07/BD_FGases_site_07_2022.pdf.



Activity Data – Disposal

It was assumed a lifetime of 10 years.

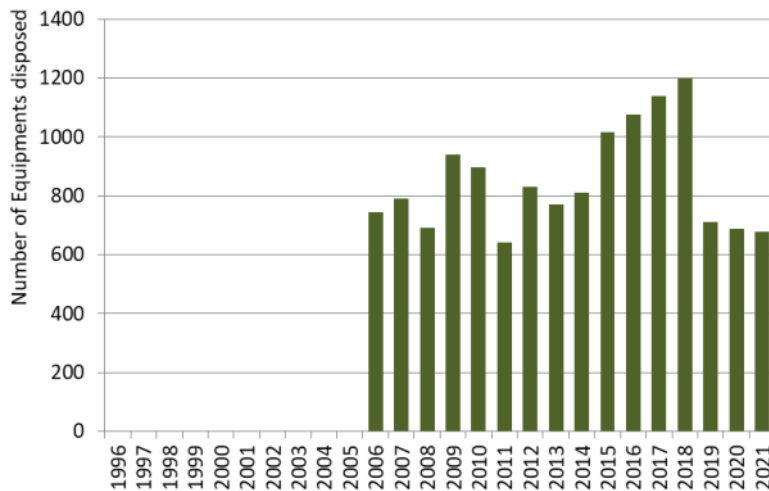

Figure 4-53: Disposal of equipment using HFC

4.7.5.5 Uncertainty Assessment

We used a triangular distribution to estimate uncertainty values based on the minimum and maximum of the range proposed by the 2006 IPCC Guidelines and the more probable value (expert judgment).

Table 4-63: Uncertainty parameters for Transport Refrigeration

Parameter	Minimum Value	Maximum Value	Selected Value	U(%)
Number of equipment	-	-	-	10.0%
Initial Charge	1.57	10.00	5.35	32.2%
% HFC				30.0%
AD Combined Uncertainty	-	-	-	45.1%
Lifetime	6	10	10	8.2%
Initial Emission	0.2	1.0	1.0	16.3%
Lifetime Emission	15	50	32.5	22.0%
Residual charge remaining at disposal	0	50	50	20.4%
Recovery efficiency at disposal	0	70	70	23.8%
EF Combined Uncertainty	-	-	-	42.4%

4.7.5.6 Category specific QA/QC and verification

QA/QC procedures included a series of checks: calculation formulas verification, data and parameters verification and the information provided in this report.

4.7.5.7 Recalculations

2020 activity data was updated. Also, minor recalculations regarding this sub-sector for the whole time series resulted from the adoption of the latest GWP according to AR5.

4.7.5.8 Further Improvements

No further improvements are expected.



4.7.6 Mobile Air Conditioning (CRF 2.F.1.e)

4.7.6.1 Category description

This chapter intends to estimate emissions from Mobile air conditioning systems from road transportation and railways in Portugal.

Mobile air conditioning systems represented the third largest share of HFC emissions within the Portuguese Refrigeration and Air Conditioning sector in 2021 (18%).

4.7.6.2 Methodology

Regarding railways, HFC emissions from MAC systems were estimated using the same methodology as in Transport Refrigeration (2.F.1.d).

As for mobile air conditioning systems from road transportation, we only consider emissions from MACs filled with HFC-134a, given that R-12 is not a GHG (moreover, was already covered by the Montreal Protocol) and CRF tables do not include refrigerant HFO-1234yf.

HFC-134a emissions from Mobile Air Conditioning equipment were estimated using a bottom-up approach Tier 2a according to chapter 7.5 of Volume 3 of the 2006 IPCC Guidelines.

ASSEMBLY PHASE

HFC-134a emissions when charging new MAC equipment into vehicles were estimated by the following equation:

Equation 4-57: Emissions when charging new MAC equipment

$$Emi_{charge} = N_{MAC} \times \frac{m_{MAC}}{1000} \times \frac{k}{100}$$

Where:

Emi_{charge} : Emissions of HFC-134a during vehicle manufacture/assembly, by type of vehicle (t of fluid)

N_{MAC} : Number of vehicles manufactured/assembled in Portugal with MAC filled with HFC-134a, by type of vehicle (nr)

m_{MAC} : Initial charge of HFC-134a into each MAC, by type of vehicle (kg fluid/equipment)

k : Initial emission factor of HFC-134a charged into new MAC, by type of vehicle (%)

OPERATION PHASE

HFC-134a emissions during MAC equipment lifetime were estimated by the following equation:

Equation 4-58: Emissions during MAC equipment lifetime

$$Emi_{lifetime} = V_{MAC} \times \frac{m_{MAC}}{1000} \times \frac{\chi}{100}$$

Where:

$Emi_{lifetime}$: Emissions of HFC-134a during MAC system lifetime, by type of vehicle (t of fluid)

V_{MAC} : Number of vehicles circulating in Portugal with MAC filled with HFC-134a, by type of vehicle (nr)

m_{MAC} : Initial charge of HFC-134a in each MAC, by type of vehicle (kg fluid/equipment)

χ : Operation emission factor of HFC-134a in MAC, by type of vehicle (%)

**DISPOSAL PHASE**

HFC-134a emissions at MAC system end-of-life (Disposal) assumed that a MAC system has the same lifetime as the vehicle and were estimated by the following equation:

Equation 4-59: Emissions at MAC system end-of-life (Disposal)

$$Emi_{end-of-life} = V_{end-of-life} \times \frac{m_{MAC}}{100} \times \frac{p}{100} \times \left(1 - \frac{\eta_{rec}}{100}\right)$$

Where:

$E_{end-of-life}$: Emissions of HFC-134a during MAC system disposal, by type of vehicle (t of fluid)

$V_{end-of-life}$: Number of vehicles at end-of-life in Portugal with MAC filled with HFC-134a, by type of vehicle (nr)

m_{MAC} : Initial charge of HFC-134a in each MAC, by type of vehicle (kg fluid/equipment)

p : Initial charge of HFC-134a remaining in MAC at vehicle disposal (%)

η_{rec} : Recovery efficiency at disposal (%)

4.7.6.3 Emission Factors**4.7.6.3.1 Emission Factors – Road Transportation**

Emission factors and parameters considered for this activity are listed in the table below. The values proposed for MAC's initial charge by type of vehicle are based on national manufacturers and suppliers. Given that there is no national data available regarding the other parameters, 2006 IPCC Guidelines for "Mobile AC" recommend the use of default emission factors shown in Table 7.9 of chapter 7, Volume 3. The values considered are within the ranges proposed in Table 7.9.

Table 4-64: Mobile Air Conditioning emission factors and parameters for Road Transportation

Description	Unit	Passenger Cars	Light Duty Vehicles	Heavy Duty Vehicles	Buses and Coaches
Initial Charge (1)	Kg/equipment	0.77	0.77	1.20	7.50
Initial Emission (k) (2)	%	0.35	0.35	0.35	0.35
Operation Emission (χ) (3)	%	15	15	15	15
p (initial charge remaining) (4)	%	40	40	40	40
η (recovery efficiency at disposal) (5)	%	35	35	35	35

(1) Average value based on Portuguese manufacturers survey in 2005

(2) Average value taken from Table 7.9 of the 2006 IPCC Guidelines (0.2-0.5 % of initial charge for Mobile A/C)

(3) Average value taken from Table 7.9 of the 2006 IPCC Guidelines (10-20 % of initial charge for Mobile A/C)

(4) Default value from Table 3.23 of the IPCC Good Practice Guidance (in line with the values proposed in Table 7.9 of the 2006 IPCC Guidelines - 0-50 % for Mobile A/C)

(5) In line with the values proposed in Table 7.9 of the 2006 IPCC Guidelines (0-50 % for Mobile A/C)

4.7.6.3.2 Emission Factors – Railways

The following emission factors and parameters were considered for this activity, the majority corresponding to values within the ranges proposed in Table 7.9 of chapter 7 of the 2006 IPCC Guidelines for "Mobile AC". MAC's initial charge by crew/passenger room values proposed are based on national manufacturers and suppliers.

**Table 4-65: Mobile Air Conditioning emission factors and parameters for Railways**

Description	Unit	Value	Source
Initial Charge	Kg/equipment	1.05-1.50 (crew room) 4-20 (passenger room)	Average value based on Portuguese manufacturers survey in 2005
Initial Emission (k)	%	0.5	German NIR
Operation Emission (χ)	%	6	German NIR
Lifetime (d)	Years	25	German NIR
p (initial charge remaining)	%	40	Default value from Table 3.23 of the IPCC Good Practice Guidance (in line with the values proposed in Table 7.9 of the 2006 IPCC Guidelines - 0-50 % for Mobile A/C)
η (recovery efficiency at disposal)	%	35	In line with the values proposed in Table 7.9 of the 2006 IPCC Guidelines (0-50 % for Mobile A/C)

4.7.6.4 Activity Data

Estimates for Road Transportation and Railways were made separately.

4.7.6.4.1 Activity Data – Road Transportation

BRIEF CONTEXTUALIZATION

In the 1980s there were practically no cars circulating with Mobile Air Conditioning (MAC) in Portugal.

In the 1990s and until around 2000, ODS R-12 (GWP of 10900) was used in MAC systems, but only for top-of-the-range passenger vehicles circulating in Portugal. All other vehicles in Portugal did not have MAC.

Following the Montreal Protocol, ODS R-12's phasing-out process led to the globalization of the use of the refrigerant HFC-134a (GWP of 1430), specifically in the mobile air conditioning sector. Therefore, in the period 2000-2005, when the use of vehicles became widespread in Portugal, there was a generalized use of MAC systems filled with HFC-134a fluid.

In the last few years, HFC-134a's phasing-out has already been taking place, due to regulations in the European Union such as the MAC Directive¹³ and their implementation, which covers MACs fitted to passenger cars (vehicles of category M1) and light commercial vehicles (category N1, class 1).

According to this Directive, AC-refrigerants exceeding a GWP of 150 are not allowed for new car models since 2011. Since 2017, no new cars with AC-refrigerants exceeding GWP 150 are allowed. MAC directive does not specify any refrigerant or system, leaving the technical choice to car manufacturers. Nevertheless, the automotive industry began launching new vehicle models using refrigerant HFO-1234yf (GWP 4), which is why this low GWP refrigerant gas has been adopted globally. However, due to supply problems with alternative use of HFO-1234yf generally adopted by vehicle industry, the European Commission accepted to refrain from launching infringement procedures in cases where vehicle production would continue to be done with the gas R134a until 31 December 2012. Therefore, there has been a delay in the replacement of HFC-134a, namely in Portugal.

Retrofitting of R-12 / HFC-134a with HFO-1234yf is not possible (incompatible AC systems). Vehicles equipped in MAC filled with R-12 / HFC-134a fluids maintain them until the end of its life. In these cases, any repairs / maintenance carried out to MAC systems are made with the original fluid until equipment / vehicle's end of life or until more restrictive legislation comes out that requires it.

¹³ <https://eur-lex.europa.eu/legal-content/EN/TXT/PDF/?uri=CELEX:32006L0040&from=EN>



OVERVIEW OF THE ACTIVITY DATA

In order to apply the Tier 2a methodology suggested in chapter 7.5.2, Volume 3 of the 2006 IPCC Guidelines, detailed information regarding vehicles assembled, in circulation or at end-of-life was required for the whole time series. However, due to unavailability of such national data, we used information from the automotive industry and vehicle inspection services in circulation and assumptions regarding the penetration of AC technology in the road transport sector.

The following table compiles the assumptions considered to characterize the national vehicle fleet. The values presented in this table are the result of the combination of default information provided by COPERT V (software used to estimate combustion emissions from the road sector)¹⁴ and expert judgment from the automotive sector experts in order to better portray the penetration of MAC systems in Portugal and the fluids used in this equipment.

Table 4-66: AC shares considered to characterize the national vehicle fleet, by type of vehicle and EURO-Standard

Category	Segment	Euro Standard	From	to	Vehicles with AC [%]	Share of R-134a usage on AC [%]
Passenger Cars	All segments	PRE Euro	...	1992	1%	9%
		Euro 1	1993	1996	20%	85%
		Euro 2	1997	2000	60%	100%
		Euro 3	2001	2005	85%	100%
		Euro 4	2006	2010	95%	100%
		Euro 5	2011	2014	95%	94%
		Euro 6 a/b/c	2015	2018	95%	19%
		Euro 6 d-temp	2019	2020	95%	0%
		Euro 6 d	2021	...	95%	0%
Light Commercial Vehicles	All segments	PRE Euro	...	1994	1%	9%
		Euro 1	1995	1998	20%	100%
		Euro 2	1999	2001	60%	100%
		Euro 3	2002	2006	85%	100%
		Euro 4	2007	2011	95%	100%
		Euro 5	2012	2015	95%	92%
		Euro 6 a/b/c	2016	2017	95%	61%
		Euro 6 d-temp	2018	2020	95%	55%
				Euro 6 d	2021	...
Heavy Duty Trucks & Buses and Coaches	All segments	PRE Euro		1993	0%	1.3%
		Euro I	1994	1996	8%	93%
		Euro II	1997	2001	48%	100%
		Euro III	2002	2006	85%	100%
		Euro IV	2007	2009	95%	100%
		Euro V	2010	2013	95%	100%
		Euro VI A/B/C	2014	2018	95%	100%
		Euro VI D/E	2019	...	95%	100%

¹⁴ This software considers the operation of air conditioning systems in estimating fuel consumption. For detailed information regarding this software please consult chapter 3.5.2 of the Energy sector.



ASSEMBLY PHASE

Methodology applied for vehicle assembly phase takes into account the MAC Directive, as well as the number of new vehicles assembled in Portugal, by type of vehicle and EURO-standard.

The total number of vehicles assembled in Portugal, by type of vehicle, was obtained from ACAP for the whole time series. The number of vehicles assembled with AC systems and fluids installed are based on the shares from the table above. This table reflects the following assumptions considered for vehicle assembly in Portugal:

- From 1995 to 2013, all MAC systems in vehicles assembled in Portugal were filled with refrigerant HFC-134a;
- It is possible that some vehicle brands have begun to introduce low-GWP fluids in MAC systems already before the commitment periods established by the MAC directive. However, given there is no available national data on that matter, for the time being we assumed the implementing dates of the Directive;
- According to the MAC directive, from 2011 onwards all new type-approved vehicles (new models) should be equipped with low-GWP fluids. However, according to the above-mentioned European Commission's decision, we assume that this measure only started to take force since 2013, and in a phased manner in Portugal. We considered that from 2013 to 2017 was a period of transition between HFC-134a and HFO-1234yf for passenger cars (vehicles of category M1) and light commercial vehicles (category N1, class 1);
- Also according to the MAC Directive, since 1 January 2017, MAC systems in all new passenger cars (vehicles of category M1) and light commercial vehicles (category N1-I) put on the market are no longer filled HFC-134a;
- Assuming a conservative approach, MAC systems in all new light commercial vehicles from categories N1-II and N1-III, as well as heavy duty trucks, buses and L-Category vehicles, are filled with HFC-134a.

The figure below presents the number of vehicles assembled in Portugal with AC systems and fluids installed.

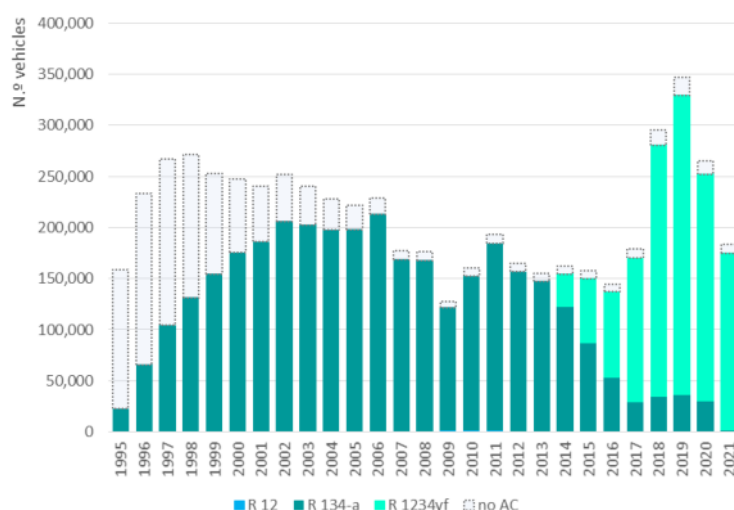

Figure 4-54: Vehicles assembled in Portugal by type of MAC fluid



OPERATION PHASE

Methodology applied for the operation phase takes into account vehicles circulating in Portugal by type of vehicle and EURO-standard.

Sub-chapter 3.5.2.4.5 Vehicle Fleet of the Energy sector details how information regarding the total number of vehicles circulating in Portugal, by type of vehicle, for the whole time series, was obtained. The number of vehicles circulating with AC systems and fluids installed are based on the shares from Table 4-66.

The following assumptions were made regarding the national vehicle fleet circulating in Portugal:

- National circumstances over the years have caused an overall growing of the vehicle fleet, but also of the average lifespan of vehicles. This means that a large percentage of vehicles currently circulating in Portugal are above 13 years old;
- Upon contact with sectoral automobile associations, we consider there was no retrofit of R-12 with R-134a in Portugal. Vehicles with MAC filled with R-12 maintained it until the end of its life. All new vehicles were already assembled with MACs filled with R-134a;
- It is possible that HFO-1234yf is not the only fluid with GWP <150 in MAC systems in vehicles circulating in Portugal, however, we can assume that, for the time being, the existence of fluids with GWP <150 other than HFO-1234yf is negligible.

The figure below presents the number of vehicles circulating in Portugal with AC systems and fluids installed.

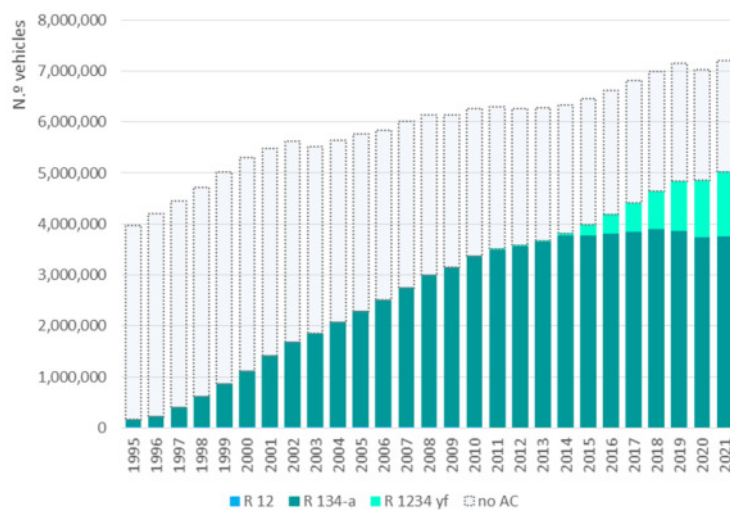

Figure 4-55: Fleet of vehicles circulating in Portugal by type of MAC fluid



DISPOSAL PHASE

Methodology applied for the disposal phase takes into account the national vehicle fleet, by type of vehicle and EURO-standard.

End-of-life vehicle fleet in each year was estimated considering the vehicles that stopped performing periodic inspections in each year and therefore assumed to be removed from circulation. The number of vehicles at end-of-life with AC systems and fluids installed are based on the shares from the Table 4-66.

The following assumptions were made regarding vehicles at end-of-life in Portugal:

- National circumstances over the years have caused an overall growing of the average lifespan of vehicles. This means that the majority of vehicles currently at end-of-life in Portugal is above 20 years old. Therefore, the default lifetime values suggested in Table 7.9 of chapter 7.5.2.2 Volume 3 of the 2006 IPCC Guidelines were not used, as it is understood that they do not reflect the Portuguese reality. This also means that the majority of vehicles currently at end-of-life in Portugal is not equipped with MAC systems;
- The small (but growing) percentage of end-of-life vehicles equipped with MAC systems is still filled with R-12 (not accounted for in the inventory, for reasons already mentioned) or HFC-134a. Upon contact with vehicle abatement association, we considered the percentage of end-of-life vehicles equipped with HFO-1234yf MAC systems negligible;
- Not all vehicles at end-of-life are delivered in licensed abatement operators, however, we considered that percentage negligible;
- Most vehicles at end-of-life that are delivered in licensed abatement operators are of passenger and light commercial type. Upon contact with the vehicle abatement association, we found that up to 2018, statistics relating to end-of-life vehicles abatement only concerned passenger and light commercial vehicle types. Only from 2018 onwards, statistics relating to end-of-life vehicles abatement encompass all vehicle types. Therefore, these statistics were not used for the time being, given that they do not reflect the totality of national circumstances;
- In Portugal, the recovery of the fluid in MAC systems of end-of-life vehicles in licensed abatement operators became mandatory since 2003, however, it only concerns passenger and light commercial vehicle types. Before 2003, no national data on fluid recovery from MAC equipment is available. Therefore, these data were not used for the time being, given that they do not reflect the totality of national circumstances, and a recovery efficiency default value within the range suggested in Table 7.9 of chapter 7.5.2.2 Volume 3 of the 2006 IPCC Guidelines was used;
- No national data on initial charge remaining on MAC equipment at end-of-life is available. Therefore, a default value within the range suggested in Table 7.9 of chapter 7.5.2.2 Volume 3 of the 2006 IPCC Guidelines was used;
- For the time being, the existence of fluid HFO-1234yf in MAC systems of end-of-life vehicles is considered negligible.

The figure below presents the number of vehicles at end-of-life in Portugal with AC systems and fluids installed.

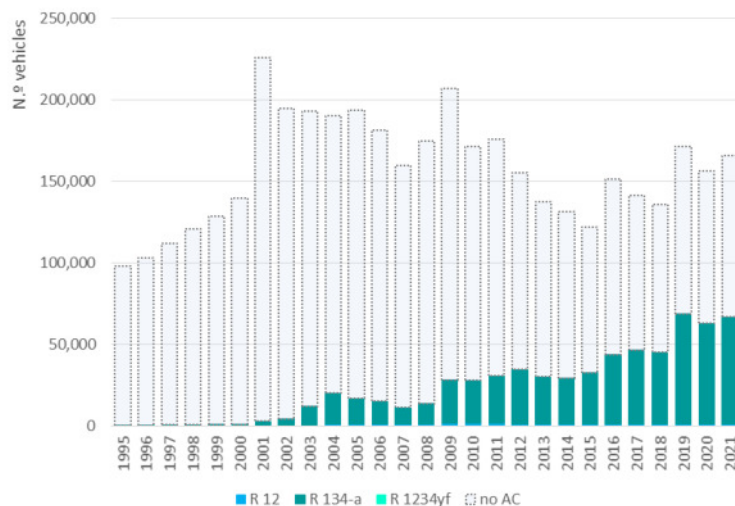

Figure 4-56: Vehicles at end-of-life by type of MAC fluid

4.7.6.4.2 Activity Data – Railways

In MAC equipment associated to Trains and Subway, HFC-134a, R-407C and R-422d fluids are used. The composition of the blends used by the inventory is the one provided by IPCC 2006 Guidelines in Table 7.8 of chapter 7 of Volume 3.

For trains, the initial charge amount was considered 1.05-1.5 kg/MAC equipment (sectoral expert judgment) and 4-20 kg/MAC equipment (sectoral expert judgment), on the crew room and on passenger rooms, respectively. Data on the fleet was obtained from national companies that explore trains and subways.

4.7.6.5 Uncertainty Assessment

We used a triangular distribution to estimate uncertainty values based on the minimum and maximum of the range proposed by the guidelines and the more probable value (expert judgment).

Table 4-67: Passenger cars and light duty vehicles

Parameter	Minimum Value	Maximum Value	Selected Value	U(%)
Number of equipment	-	-	-	10.0%
Initial Charge	0.59	0.90	0.77	8.3%
% HFC				10.0%
AD Combined Uncertainty	-	-	-	16.4%
Lifetime	9	16	16	8.9%
Initial Emission	0.20	0.50	0.35	17.5%
Lifetime Emission	10	20	15	13.6%
Residual charge remaining at disposal	0	50	40	25.5%
Recovery efficiency at disposal	0	50	35	29.2%
EF Combined Uncertainty	-	-	-	45.5%

**Table 4-68: Heavy duty vehicles**

Parameter	Minimum Value	Maximum Value	Selected Value	U(%)
Number of equipment	-	-	-	10.0%
Initial Charge	0.50	1.50	1.20	17.0%
% HFC				10.0%
AD Combined Uncertainty	-	-	-	22.1%
Lifetime	9	16	16	8.9%
Initial Emission	0.20	0.50	0.35	17.5%
Lifetime Emission	10	20	15	13.6%
Residual charge remaining at disposal	0	50	40	25.5%
Recovery efficiency at disposal	0	50	35	29.2%
EF Combined Uncertainty	-	-	-	45.5%

Table 4-69: Buses and Coaches

Parameter	Minimum Value	Maximum Value	Selected Value	U(%)
Number of equipment	-	-	-	10.0%
Initial Charge	4.50	10.00	7.50	15.0%
% HFC				10.0%
AD Combined Uncertainty	-	-	-	20.6%
Lifetime	9	16	16	8.9%
Initial Emission	0.20	0.50	0.35	17.5%
Lifetime Emission	10	20	15	13.6%
Residual charge remaining at disposal	0	50	40	25.5%
Recovery efficiency at disposal	0	50	35	29.2%
EF Combined Uncertainty	-	-	-	45.5%

Table 4-70: Railways

Parameter	Minimum Value	Maximum Value	Selected Value	U(%)
Number of equipment	-	-	-	10.0%
Initial Charge	-	-	-	10.0%
% HFC				10.0%
AD Combined Uncertainty	-	-	-	17.3%
Lifetime	20	30	25	8.2%
Initial Emission	0.2	1.0	0.5	32.7%
Lifetime Emission	1	10	6	30.6%
Residual charge remaining at disposal	-	-	-	45.5%
Recovery efficiency at disposal	-	-	-	10.0%
EF Combined Uncertainty	-	-	-	10.0%

4.7.6.6 Category specific QA/QC and verification

QA/QC procedures included a series of checks: calculation formulas verification, data and parameters verification and the information provided in this report.

4.7.6.7 Recalculations

Vehicle fleet stock for Road Transportation was updated for 1994-2020. Also, minor recalculations regarding this sub-sector for the whole time series resulted from the adoption of the latest GWP according to AR5.

4.7.6.8 Further Improvements

We intend to gather information from regulatory authority in end-of-life vehicles in order to update activity data regarding the disposal phase.



4.7.7 Stationary Air Conditioning (CRF 2.F.1.f)

4.7.7.1 Category description

Stationary Air Conditioning systems represent the largest share of HFC emissions within the Portuguese Refrigeration and Air Conditioning sector in 2021 (41%).

4.7.7.2 Methodology

It was used the same methodology as for Transport Refrigeration (2.F.1.d).

Annual stocks were estimated from assemblage data, using the following equation:

Equation 4-60: Annual stocks

$$\text{Stocks}_y = \text{Stocks}_{y-1} + \text{Assemblage}_y + \text{Disposal}_y$$

Where:

Stocks_y: Stocks of the year y

Stocks_{y-1}: Stocks of the year y-1

Assemblage_y: Equipment assembled in year y

Disposal_y: Disposal of equipment in year y

4.7.7.3 Emission Factors

Table 4-71: Stationary Air Conditioning emission factors

Description	Unit	Residential AC	Small Chillers	Medium Chillers	Large Chillers (Shopping Centers)	Large Chillers (Others)
Initial Charge (1)	Kg/equipment	0.3	100.0	200.0	441.0	600
Initial Emission (k) (2)	%	0.6	0.6	0.6	0.6	0.6
Lifetime Emission (x) (3)	%	5.5	5.5	5.5	5.5	5.5
Lifetime (4)	Years	13	20	20	20	20
p (residual charge at disposal) (5)	%	75	90	90	90	90
η (recovery efficiency at disposal) (6)	%	40	60	60	60	60

(1) Average value based on Portuguese manufacturers survey in 2005
(2) Average value taken from Table 7.9 of the 2006 IPCC Guidelines (0.2-1.0 % of initial charge for Residential and Commercial A/C)
(3) Average value taken from Table 7.9 of the 2006 IPCC Guidelines (1-10 % of initial charge for Residential and Commercial A/C)
(4) In line with the values proposed in Table 7.9 of the 2006 IPCC Guidelines (10-20 for Residential and Commercial A/C and 15-30 for Chillers)
(5) In line with the values proposed in Table 7.9 of the 2006 IPCC Guidelines (0-80 for Residential and Commercial A/C and 80-100 for Chillers)
(6) In line with the values proposed in Table 7.9 of the 2006 IPCC Guidelines (0-80 for Residential and Commercial A/C and 0-95 for Chillers)

4.7.7.4 Activity Data

4.7.7.4.1 Activity Data – Assemblage

From industry statistics it is not possible to have a clear estimate on the number of assembled units over time, as consequence of the change that occurred in the industrial survey in 1992, when IAIT was replaced by IAPI, as the later uses different products categories. IAIT survey categories are not detailed enough to differentiate the production of refrigeration components - from which no emissions occur - from their final assembling.



From 1990 to 2004, the number of assembled stationary air conditioning equipment was available from unpublished information received from IST-UTL (see figure below). From 2005 onwards, data was estimated based on GDP trend. 2020 numbers are slightly lower due to the COVID pandemic.

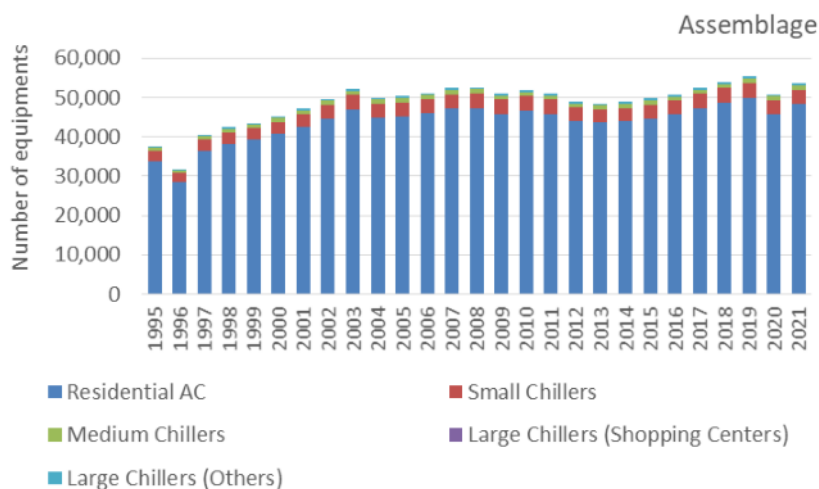

Figure 4-57: Number of Stationary Air Conditioning equipment assembled in Portugal

By expert judgment it was assumed the following share between classes of stationary air conditioning equipment:

- Residential AC: 90%;
- Small Chillers: 7%;
- Medium Chillers: 2%;
- Large Chillers: 1%.

The percentage of each Gas/Mixture, regardless of the type of equipment, can be consulted in the table below. The composition of the blends used by the inventory are those provided by IPCC 2006 Guidelines in Table 7.8 of chapter 7 of Volume 3. The composition and the GWPs of the blends used by the inventory were obtained from the Portuguese Environment Agency and can be consulted in the following link: https://apambiente.pt/sites/default/files/2022-07/BD_FGases_site_07_2022.pdf.

Table 4-72: Use of each Gas/Mixture in the assembled equipment (%)

% of Fluid	Unit	1995	2005	2019	2020	2021
HCFC-22	%	99.0	0.0	0.0	0.0	0.0
R-410A	%	0.3	29.6	58.6	58.6	58.6
R-407C	%	0.3	21.5	25.9	25.9	25.9
HFC-134A	%	0.5	31.4	5.7	5.7	5.7
R-417A	%	0.0	1.3	5.0	5.0	5.0
R-422D	%	0.0	0.7	2.7	2.7	2.7
R-404A	%	0.0	0.5	2.0	2.0	2.0



4.7.7.4.2 Activity Data – Operation and Servicing

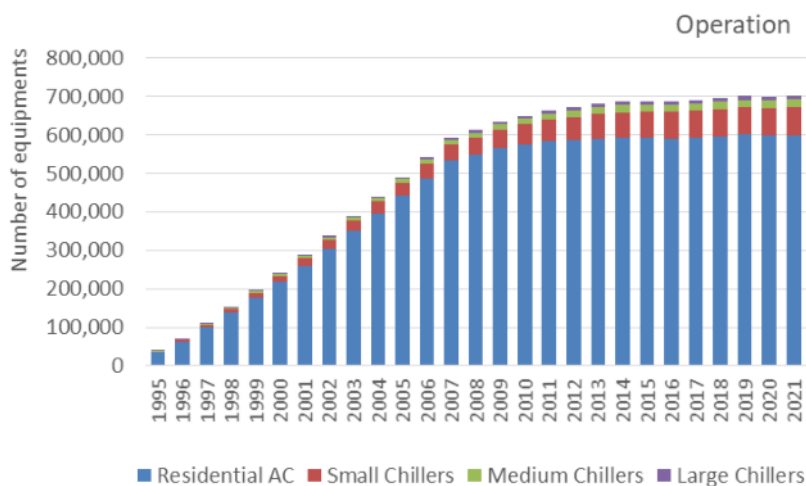

Figure 4-58: Annual Stock of Stationary Air Conditioning equipment in Portugal

4.7.7.4.3 Activity Data – Disposal

Assuming a lifetime of 13 years for residential AC, disposal emissions started in 2008. For chillers we assumed a lifetime of 20 years and disposal emissions started in 2015.

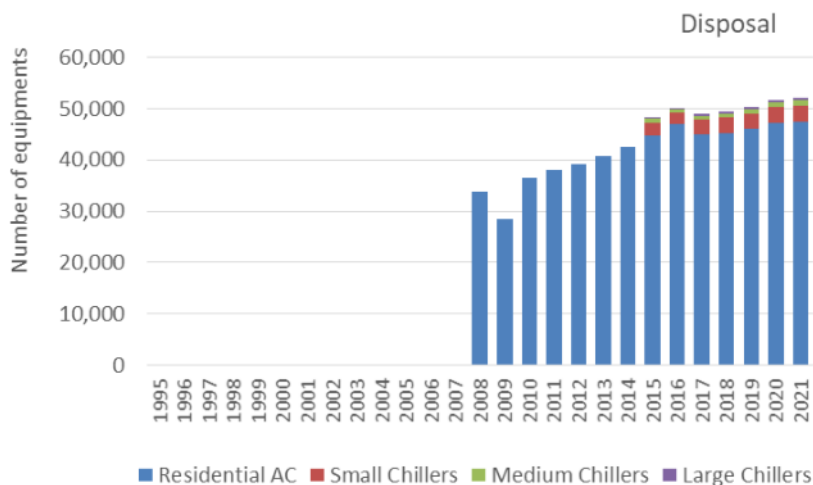

Figure 4-59: Disposal of Stationary Air Conditioning equipment in Portugal

4.7.7.4.4 Activity Data – Air conditioning equipment from shopping centres

When considering shopping centres with centralized air conditioning systems, a different methodology was used, considering specific data from each commercial area.

Data on the opening date and total area of each shopping centre was provided by APCC (Portuguese Association of Shopping Centres) until 2011. From 2012 onwards it was assumed the same annual trend verified in 2011.

Some Shopping Centres provided data on the amount of gas used to charge the air conditioning equipment. Based on the available information, the ratio between the shopping centre area and the amount of initial charge of gas was determined. This ratio was used to estimate the initial amount of gas used to fill air conditioning equipment in the Shopping Centres for which such information was not available.



4.7.7.5 Uncertainty Assessment

We used a triangular distribution to estimate uncertainty values based on the minimum and maximum of the range proposed by the guidelines and the more probable value (expert judgment).

Table 4-73: Residential AC

Parameter	Minimum Value	Maximum Value	Selected Value	U(%)
Number of equipment	-	-	-	10.0%
Initial Charge	0.2	1.0	0.3	54.4%
% HFC				30.0%
AD Combined Uncertainty	-	-	-	63.0%
Lifetime	10	20	13	15.7%
Initial Emission	0.2	1.0	0.6	27.2%
Lifetime Emission	1.0	10.0	5.5	33.4%
Residual charge remaining at disposal	0	80	75	21.8%
Recovery efficiency at disposal	0	80	40	40.8%
EF Combined Uncertainty	-	-	-	65.1%

Table 4-74: Small Chillers

Parameter	Minimum Value	Maximum Value	Selected Value	U(%)
Number of equipment	-	-	-	30.0%
Initial Charge	50	100	100	10.2%
% HFC				30.0%
AD Combined Uncertainty	-	-	-	43.6%
Lifetime	15	30	20	15.3%
Initial Emission	0.2	1.0	0.6	27.2%
Lifetime Emission	2.0	15.0	5.5	48.2%
Residual charge remaining at disposal	80	100	90	4.5%
Recovery efficiency at disposal	0	95	60	32.3%
EF Combined Uncertainty	-	-	-	66.1%

Table 4-75: Medium Chillers

Parameter	Minimum Value	Maximum Value	Selected Value	U(%)
Number of equipment	-	-	-	30.0%
Initial Charge	150	250	200	10.2%
% HFC				30.0%
AD Combined Uncertainty	-	-	-	43.6%
Lifetime	15	30	20	15.3%
Initial Emission	0.2	1.0	0.6	27.2%
Lifetime Emission	2.0	15.0	5.5	48.2%
Residual charge remaining at disposal	80	100	90	4.5%
Recovery efficiency at disposal	0	95	60	32.3%
EF Combined Uncertainty	-	-	-	66.1%

**Table 4-76: Large Chillers (Shopping Centres)**

Parameter	Minimum Value	Maximum Value	Selected Value	U(%)
Number of equipment	-	-	-	10.0%
Initial Charge	210	791	441	26.9%
% HFC				30.0%
AD Combined Uncertainty	-	-	-	41.5%
Lifetime	15	30	20	15.3%
Initial Emission	0.2	1.0	0.6	27.2%
Lifetime Emission	2.0	15.0	5.5	48.2%
Residual charge remaining at disposal	80	100	90	4.5%
Recovery efficiency at disposal	0	95	60	32.3%
EF Combined Uncertainty	-	-	-	66.1%

Table 4-77: Large Chillers (Others)

Parameter	Minimum Value	Maximum Value	Selected Value	U(%)
Number of equipment	-	-	-	30.0%
Initial Charge	250	1000	300	51.0%
% HFC				30.0%
AD Combined Uncertainty	-	-	-	66.4%
Lifetime	15	30	20	15.3%
Initial Emission	0.2	1.0	0.6	27.2%
Lifetime Emission	2.0	15.0	5.5	48.2%
Residual charge remaining at disposal	80	100	90	4.5%
Recovery efficiency at disposal	0	95	60	32.3%
EF Combined Uncertainty	-	-	-	66.1%

4.7.7.6 Category specific QA/QC and verification

QA/QC procedures included a series of checks: calculation formulas verification, data and parameters verification and the information provided in this report.

4.7.7.7 Recalculations

2020 assemblage activity data was updated. Also, minor recalculations regarding this sub-sector for the whole time series resulted from the adoption of the latest GWP according to AR5.

4.7.7.8 Further Improvements

No further improvements are planned.



4.7.8 Foam Blowing (CRF 2.F.2)

4.7.8.1 Category description

Fluorinated gases are nowadays used as blowing agents in the manufacture of foams that are used as insulating, cushioning and packaging materials.

The foam blowing agent is eventually ventilated to the atmosphere, but at a rate dependent on the type of foam and its structure. Open cell foams emit virtually all blowing agent at the time of manufacture. Closed-cell foams emit the HFC blowing agent during their lifetime at three distinct phases:

- Foam Manufacturing: emissions occur during the first year at the location where the foam is manufactured;
- Annual losses: occur where the foam is applied, resulting from the slow release of the blowing agent trapped inside the foam;
- Disposal: emissions occur when foam is removed and destroyed. The remaining gas in cells is emitted to atmosphere.

Activity data on the use of HFC in foam manufacturing in Portugal is available, allowing the estimation of manufacturing emissions. Annual losses are, however, harder to estimate because it is not known neither the quantity of closed-cells imported that were manufactured with F-gases, nor the quantities of foams that were exported with HFC. Nonetheless, assumptions are based on expert judgement.

In Portugal, there is production of Polystyrene closed-cell foams and Polyurethane open-cell foams, associated to the use of HFC-134a and HFC-152a as blowing agents.

4.7.8.2 Methodology

Methodology is classified as Tier 2a, using national data, but considering default emission factors.

First year losses from Foam Manufacture and Installation were estimated using the following equation:

Equation 4-61: First year losses

$$FGas_{Emi(t,j)} = FGas_{Consumption(t)} \times HFC_{\%(j,t)} \times (k/100)$$

Annual losses were estimated using the following equations:

Equation 4-62: F-gas in closed-cell

$$FGas_{inFoam(t,j)} = \sum_{y=t}^{t-Lifetime} [FGas_{Consumption(y)} \times HFC_{\%(j,y)}]$$

Equation 4-63: Annual losses

$$FGas_{Emi(t,j)} = FGas_{inFoam(t)} \times HFC_{\%(j,t)} \times (x/100)$$

Where:

$FGas_{Emi(t,j)}$: Emission at year t of F-gas j (t)

$FGas_{Consumption(t)}$: Total F gas consumption at year t used in closed-cell manufacturing (t)

$HFC_{\%(j,t)}$: Percentage of Fluorine gas j used at year t in closed-cell manufacturing (%)

$FGas_{inFoam(t,j)}$: Amount of F gas j in closed-cell existing in the country at year t¹⁵ (t)

¹⁵ For the time being the stock is restricted to foam filled in Portugal.



K: First year loss emission factor (%)

X: Annual loss emission factor (%)

Emissions due to decommissioning of foams were not included in estimates due to the lack of necessary information about foam stock and the expected lifetime of foams.

4.7.8.3 Emission Factors

Due to unavailability of country-specific information, default emission factors from the 2006 IPCC Guidelines were used and are listed in the table below.

Table 4-78: Foam losses emission factors

Type of Foam	Parameter	Emission Factor (% Original Charge)	Source
Open Cell	First Year Losses (k)	100	Section 7.4.2.1, Chapter 7, Volume 3, 2006 IPCC Guidelines
Closed Cell	First Year Losses (k)	10	Table 7.5, Chapter 7, Volume 3, 2006 IPCC Guidelines
Closed Cell	Annual Losses (x)	4.5	Table 7.5, Chapter 7, Volume 3, 2006 IPCC Guidelines

4.7.8.4 Activity Data

From 1995 to 2010, data on amounts of imported and exported foams by type of product were obtained from DGAE (Economic Activities General Directorate) and data on produced amounts of foam were provided by DGAE and manufacturers. From 2011 onwards, data was estimated based on the average of the period 2008-2010 and on the GDP trend.

It was considered that the use of F-gases as foam blowing agents in foams produced in Portugal was introduced in 2003. For foams imported and applied in Portugal it was considered the use of F-gases from 1995 onwards. Foam industry is shifting to the use of non-HFC agents.

The composition of the blends used by the inventory are those provided by IPCC 2006 Guidelines in Table 7.8 of chapter 7 of Volume 3. The composition and the GWPs of the blends used by the inventory were obtained from the Portuguese Environment Agency and can be consulted in the following link: https://apambiente.pt/sites/default/files/2022-07/BD_FGases_site_07_2022.pdf.

4.7.8.5 Uncertainty Assessment

We used a triangular distribution to estimate uncertainty values based on the minimum and maximum of the range proposed by the guidelines and the more probable value (expert judgment).

Table 4-79: Foam Blowing (Closed Cell)

Parameter	Minimum Value	Maximum Value	Selected Value	U(%)
Amount of foam produced	-	-	-	50.0%
% HFC	-	-	-	30.0%
AD Combined Uncertainty	-	-	-	58.3%
Lifetime	12	50	20	38.8%
Emission in first year	7.5	12.5	10.0	10.2%
Emission in subsequent years	0.5	4.5	4.5	18.1%
EF Combined Uncertainty	-	-	-	44.0%

**Table 4-80: Foam Blowing (Open Cell)**

Parameter	Minimum Value	Maximum Value	Selected Value	U(%)
Amount of foam produced	-	-	-	50.0%
% HFC	-	-	-	30.0%
AD Combined Uncertainty	-	-	-	58.3%
Emission in first year	100	100	100	0.0%
EF Combined Uncertainty	-	-	-	0.0%

4.7.8.6 Category specific QA/QC and verification

QA/QC procedures included a series of checks: calculation formulas verification, data and parameters verification and the information provided in this report.

4.7.8.7 Recalculations

2020 activity data was updated. Also, minor recalculations regarding this sub-sector for the whole time series resulted from the adoption of the latest GWP according to AR5.

4.7.8.8 Further Improvements

No further improvements are planned.

4.7.9 Fire Protection (CRF 2.F.3)

4.7.9.1 Category description

The consumption of HFC in fire protection systems in Portugal started in 1999. The fire protection equipment used in Portugal contain HFC-227ea and HFC-236fa.

4.7.9.2 Methodology

We assume there are no emissions from the assembly of the fire protection equipment.

Emissions during equipment lifetime are estimated considering the stock of fluid present in all fire protection equipment in Portugal in a given year and applying a lifetime emission factor of 4% per year, according to the following equation:

Equation 4-64: Emissions during equipment lifetime

$$\text{Emissions}_{Op} = \text{Bank}_y \times \text{EF}/100$$

Where:

Emissions_{Op} : Total emissions from operation of fire protection equipment (t)

Bank_y : bank of F-Gas in fire protection equipment in year y (t)

EF: fraction of F-Gas in equipment emitted each year (%)

The bank of F-gas in each year is estimated considering the Stock Existing in the Previous Year, Fluid in new equipment and the Fluid in Disposed Equipment, according to the following equation:



Equation 4-65: Bank of F-gas

$$\text{Bank}_y = \text{Bank}_{y-1} + \text{FGas}_{\text{NE } y} - \text{FGas}_{\text{DE } y}$$

Where:

Bank_y : bank of F-Gas in fire protection equipment in year y (t)

Bank_{y-1} : bank of F-Gas in fire protection equipment in previous year (t)

$\text{FGas}_{\text{NE } y}$: amount of F-Gas in new equipment in year y (t)

$\text{FGas}_{\text{DE } y}$: amount of F-Gas in Disposed Equipment in year y (t)

In order to estimate disposal emissions from fire protection equipment we assume the following:

- . at the time of equipment disposal, the equipment is 100% charged;
- . 100% of HFC contained in the equipment is emitted at the time of equipment disposal;
- . a conservative approach of 0% gas recovery at the end of life of the fire protection equipment.

Assuming an average lifetime of 18 years for a fire protection equipment, since Portugal only started using fluorinated gases in fire protection equipment in 1999, the first equipment disposal occurred in 2017. From 1999 to 2016 emissions from disposal were not occurring.

From 2017 onwards, disposal emissions are estimated considering the amount of fluid present in the equipment at the time of disposal and the amount of fluid that is recovered, based on the following equation:

Equation 4-66: Disposal emissions

$$\text{Emissions}_{\text{Disp}} = \text{FGas}_{\text{DE } y} \times \% \text{ charge}_{\text{DE } y} \times (1 - \text{Recovery})$$

Where:

$\text{Emissions}_{\text{Disp}}$: Total emissions from disposal of fire protection equipment (t)

$\text{FGas}_{\text{DE } y}$: amount of F-Gas in Disposed Equipment in year y (t)

$\% \text{ charge}_{\text{DE } y}$: charge of F-Gas at the time of disposal (%)

Recovery: fraction of F-Gas recovered at the time of disposal (0-1)

The amount of fluid in equipment disposed each year is estimated considering an average lifetime of the fire protection equipment. Thus, it is considered that at the end of 18 years the equipment introduced in Portugal is dismantled, according to the following equation:

Equation 4-67: Amount of F-gas in equipment at disposal phase

$$\text{FGas}_{\text{DE } y} = \text{FGas}_{\text{Assembled in year } t-18}$$

Where:

$\text{FGas}_{\text{DE } y}$: amount of F-Gas in Disposed Equipment in year y (t)

$\text{F-Gas}_{\text{Assembled in year } t-18}$: F-Gas charged in fire protection equipment in year t-18 (t)



4.7.9.3 Emission Factors

Due to unavailability of country-specific information, default parameter assumptions from the 2006 IPCC Guidelines (Section 7.6.2.2, Chapter 7, Volume 3) were used and are listed in the following table:

Table 4-81: Fire Protection losses emission factors

Parameter	Unit	Emission Factor	Source
Lifetime Emission (x)	%	4	Average annual emission rate (2-6%) for
Lifetime	Years	18	Average typical lifetime for flooding systems (15-20 years)
p (residual charge at disposal)	%	100	Expert Judgement
η (recovery efficiency at disposal)	%	0	Good practice for countries without a national Industry Code of Practice

4.7.9.4 Activity Data

For the period 1999-2010, data on amounts of used gases in fire extinguishing equipment was provided by sellers and responsible enterprises for equipment filling.

From 2011 onwards, these values were forecasted based on the average of the period 2005-2010. It was made a streamline with the national enquiry on fluorinated gases consumption. These equipment contain HFC-227ea and HFC-236fa gases (see figure below). The replacement of halons by HFC during 2000-2004 period in order to fulfil Regulation (EC) No. 2037/2000 is reflected in the consumption increase. In the period 2005-2009 there is a decrease in consumption values associated to market saturation.

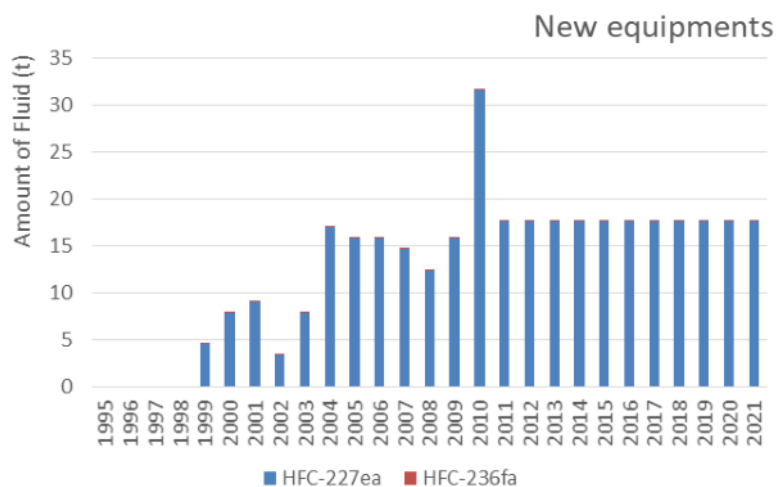

Figure 4-60: HFC consumption in new Fire protection equipment by type of gas

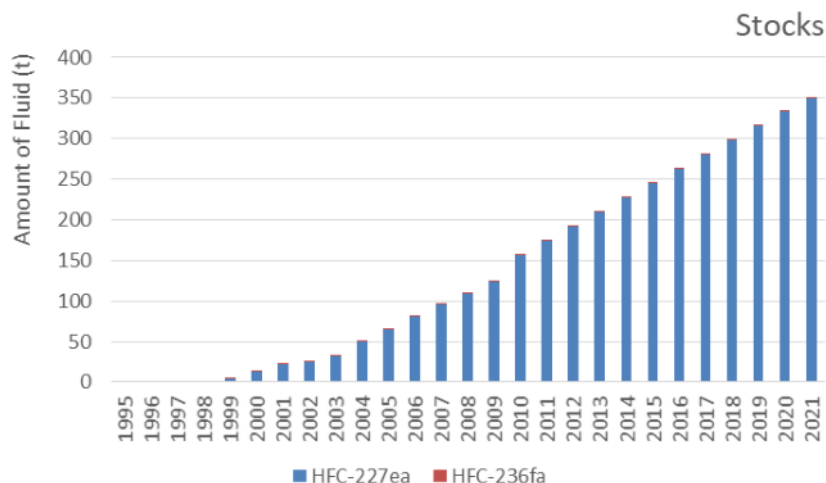

Figure 4-61: Stocks of HFC in Fire protection equipment by type of gas

4.7.9.5 Uncertainty Assessment

We used a triangular distribution to estimate uncertainty values based on the minimum and maximum of the range proposed by the guidelines and the more probable value (expert judgment).

Table 4-82: Fire protection

Parameter	Minimum Value	Maximum Value	Selected Value	U(%)
Charge amount	-	-	-	30.0
% HFC	-	-	-	30.0
AD Combined Uncertainty	-	-	-	42.4
Lifetime	15	20	18	5.7
Lifetime emissions (%)	2	6	4	20.4
EF Combined Uncertainty	-	-	-	21.2

4.7.9.6 Category specific QA/QC and verification

QA/QC procedures included a series of checks: calculation formulas verification, data and parameters verification and the information provided in this report.

4.7.9.7 Recalculations

2020 activity data was updated. Also, minor recalculations regarding this sub-sector for the whole time series resulted from the adoption of the latest GWP according to AR5.

4.7.9.8 Further Improvements

Following a 2018 UNFCCC review, we received a recommendation relating to the revision of the assumptions on recovery and disposal losses for this category.

Under Regulation (EC) No 842/2006, and later, Regulation (EU) No. 517/2014, a national reporting tool was created, where national operators report the use of fluorinated greenhouse gases.

However, according to that same regulation, only those operators that fulfil the following requirement - load equal to or greater than 5 ton - are obliged to report. Therefore, we don't have access to data of all national operators (which include the report of fire protection systems), so we don't work with those data.

Upon a contact with the Waste Management Department at our premises, we found that we only have access to the total national amounts of HFC and CFC which are recovered for destruction or for recycling. However, these amounts are not disaggregated per type of equipment – they correspond to national totals of F-gases.



Concerning enforcement measures taken under that regulation, article 20 of Decree-law No. 144/2017, regarding fluorinated greenhouse gases, states the following:

“1 - Whenever a fire extinguisher or a fire protection system, containing fluorinated gas with greenhouse effect, reaches the end of its life, the operator must resort to a certified technician in accordance with this decree-law, which ensures proper dismantling and forwarding to the adequate gas container manufacturer.

2 - The manufacturer must carry out, at his premises, the recovery of the fluorinated greenhouse gases contained in the equipment, in order to ensure their recycling, regeneration or destruction.”

Presently, the estimation of HFC emissions in fire protection systems is based on a conservative approach of 0 % gas recovery, following the guidance of chapter 7.6.2.2 of Volume 3 of the 2006 IPCC guidelines. However, in the light of the above mentioned information, we consider that such approach is not the most adequate. Due to other priority issues in our Methodological Plan (PDM), we have not yet collected further data in order to revise the assumptions on recovery and disposal losses for this category, however, we intend to gather information in order to address this issue in the future.



4.7.10 Aerosols – Metered Dose Inhalers (CRF 2.F.4.a)

4.7.10.1 Category description

Fluorinated gases are used as propellants in pressurized solutions (metered dose inhalers) in the treatment of asthma.

4.7.10.2 Methodology

It is assumed that the gas is partly emitted during the same year the inhaler is sold and in the subsequent year, according to the following equation:

Equation 4-68: F-gas emissions from metered dose inhalers

$$Emi_{HFC,t} = [\sum(\text{Sold MDI}_{t-1} \times K_{t-1}) + \sum(\text{Sold MDI}_t \times K_t)] / 2 \times 1 \times 10^{-6}$$

Where:

$Emi_{HFC,t}$: F-Gas emissions from metered dose inhalers in year t (t)

Sold MDI_{t-1} : Number of sold units of each MDI in year t-1

K_{t-1} : Charge of gas of each equipment sold in year t-1

Sold MDI_t : Number of sold units of each MDI in year t

K_t : Charge of gas of each equipment sold in year t

4.7.10.3 Emission Factors

Each manufacturer provided charge values for each type of inhaler. However, the yearly average emission factor lies in the range [12.05-14.75] g/inhaler.

4.7.10.4 Activity Data

Information was gathered on the amounts of sold inhalers charged with F-gases in the period 1990-2010. From 2011 onwards, data was estimated based on gross domestic trend. Information on the % of propellant (F-gas) for each type of inhaler was also provided. The two F-gases in inhalers are HFC-134a and HFC-227ea.

4.7.10.5 Uncertainty Assessment

Table 4-83: Metered Dose Inhalers

Parameter	U(%)
AD Combined Uncertainty	30
EF Combined Uncertainty	50

4.7.10.6 Category specific QA/QC and verification

QA/QC procedures included a series of checks: calculation formulas verification, data and parameters verification and the information provided in this report.

4.7.10.7 Recalculations

2020 activity Data was updated. Also, minor recalculations regarding this sub-sector for the whole time series resulted from the adoption of the latest GWP according to AR5.

4.7.10.8 Further Improvements

MDI charge values will be further analysed with the Portuguese Association for Pharmaceutical Products.



4.7.11 Aerosols – Other Aerosols (CRF 2.F.4.b)

4.7.11.1 Category description

Emissions from fluorinated gases used as other aerosols were estimates based on Spain data.

4.7.11.2 Methodology

Emissions from other aerosols were estimated according to the following equations:

Equation 4-69: 2015 Portuguese activity data for other aerosols

$$AD_{Portugal,2015} = AD_{Spain,2015} \times \frac{Population_{Portugal,2015}}{Population_{Spain,2015}}$$

Where:

$AD_{Portugal,2015}$: Activity data in Portugal in year 2015 (t HFC-134a)

$AD_{Spain,2015}$: Activity data in Spain in year 2015 (t HFC-134a)

$Population_{Portugal,2015}$: Population in Portugal in year 2015 (Number of persons)

$Population_{Spain,2015}$: Population in Spain in year 2015 (Number of persons)

Equation 4-70: Portuguese activity data for other aerosols for year y

$$AD_{Portugal,y} = AD_{Portugal,2015} \times \frac{Population_{Portugal,y}}{Population_{Portugal,2015}}$$

Where:

$AD_{Portugal,y}$: Activity data in Portugal in year “y” (t HFC-134a)

$AD_{Portugal,2015}$: Activity data in Portugal in year 2015 (t HFC-134a)

$Population_{Portugal,y}$: Population in Portugal in year “y” (Number of persons)

$Population_{Portugal,2015}$: Population in Portugal in year 2015 (Number of persons)

Equation 4-71: F-gas emissions from other aerosols

$$Emis_{Portugal,y} = AD_{Portugal,y} \times EF$$

Where:

$Emis_{Portugal,y}$: Emissions in Portugal in year “y” (t HFC-134a)

$AD_{Portugal,y}$: Activity data in Portugal in year “y” (t HFC-134a)

EF: Emission Factor (%)

4.7.11.3 Emission Factors

We have considered a product manufacturing factor of 1.5% and a product life factor of 100%.

4.7.11.4 Activity Data

We have assumed the Spanish activity data (136.32 t of R-134a filled into new manufactured products in 2015 and 29.57 in operating systems) and did a correction to the Portuguese reality based on the difference between Spain and Portugal population.



4.7.11.5 Uncertainty Assessment

Table 4-84: Other Aerosols

Parameter	U(%)
AD Combined Uncertainty	10
EF Combined Uncertainty	2

4.7.11.6 Category specific QA/QC and verification

QA/QC procedures included a series of checks: calculation formulas verification, data and parameters verification and the information provided in this report.

4.7.11.7 Recalculations

2020 activity data was updated. Also, minor recalculations regarding this sub-sector for the whole time series resulted from the adoption of the latest GWP according to AR5.

4.7.11.8 Further Improvements

Efforts will be made in order to obtain national data on other aerosols applications in Portugal.



4.8 Other Product Manufacture and Use (CRF 2.G)

4.8.1 Overview

This chapter is intended to estimate SF₆ and PFCs that result from the manufacture and use of electrical equipment and a number of other products. It also provides methods for estimating emissions of nitrous oxide from several products. In most of these applications, the SF₆, PFC, or N₂O is deliberately incorporated into the product to exploit one or more of the physical properties of the chemical.

4.8.2 Manufacture of Electrical Equipment (CRF 2.G.1.a)

4.8.2.1 Category description

In Portugal, sulphur hexafluoride (SF₆) is used in the electrical equipment manufacturing sector, as current interruption media in switch-gears and circuit breakers. Due to the scarce number of national electrical equipment manufacturers, activity data and emission factors are reported as “C” (confidential) and we only present emissions values.

For 2013 and 2014, it was assumed the same trend verified for each subsector between 2011 and 2012 emissions.

4.8.2.2 Methodology

It is used a Tier 1 methodology based on SF₆ consumption by manufacturers and on emission factors in line with the 2006 IPCC Guidelines.

Emissions are estimated using the following equation:

Equation 4-72: SF₆ emissions from manufacture of electrical equipment

$$\text{Emissions} = \text{EF} \times \text{SF}_6 \text{ consumption}$$

Where:

Emissions: SF₆ emissions (t)

EF: Fraction of SF₆ emitted during electrical equipment manufacturing (%)

SF₆ consumption: Annual SF₆ consumption (t)

4.8.2.3 Emission Factors

Due to confidentiality constraints it was not possible to publish the chosen emission factors, however they are in line with the 2006 IPCC Guidelines. We assumed that 50% of the manufactured equipment are sealed pressure and the other 50% are closed pressure.

4.8.2.4 Activity Data

From 1995 onwards, activity data on SF₆ consumption in electric equipment manufacturing was obtained from national equipment producers via the F-gas Tool, however, due to confidentiality constraints, it was not possible to publish the chosen activity data. We assumed that 50% of the manufactured equipment are sealed pressure and the other 50% are closed pressure.

4.8.2.5 Uncertainty Assessment

The uncertainty in activity data was set at 10 %, since SF₆ consumption in electrical equipment manufacturing was obtained directly from manufacturers. It was used a 20% uncertainty for sealed-pressure equipment emission factor and a 30% uncertainty for closed-pressure equipment as advised in Table 8.5 of 2006 IPCC Guidelines for National Greenhouse Gas Inventories.



4.8.2.6 Category specific QA/QC and verification

QA/QC procedures included a series of checks: calculation formulas verification, data and parameters verification and the information provided in this report.

4.8.2.7 Recalculations

Minor recalculations regarding this sub-sector for the whole time series resulted from the adoption of the latest SF₆ GWP according to AR5.

4.8.2.8 Further Improvements

No further improvements are expected.

4.8.3 Use of Electrical Equipment (CRF 2.G.1.b)

4.8.3.1 Category description

In Portugal, sulphur hexafluoride (SF₆) is used in the electrical sector, both as insulation gas in substations and as current interruption media, mostly in switch-gear and in circuit breakers. While most gas is recovered at equipment disposal, emissions occur annually as consequence of leaks and equipment failure.

The Portuguese National Electric System (SEN) is comprised by the Public Service Electric System (SEP) and by the Independent Electric System (SEI). In the second semester of 2000 the separation between the network for electricity transport at very high voltage (concession to REN – National Electric Net) and the network for electricity distribution at low, medium and high voltage (EDP Distribuição) took place.

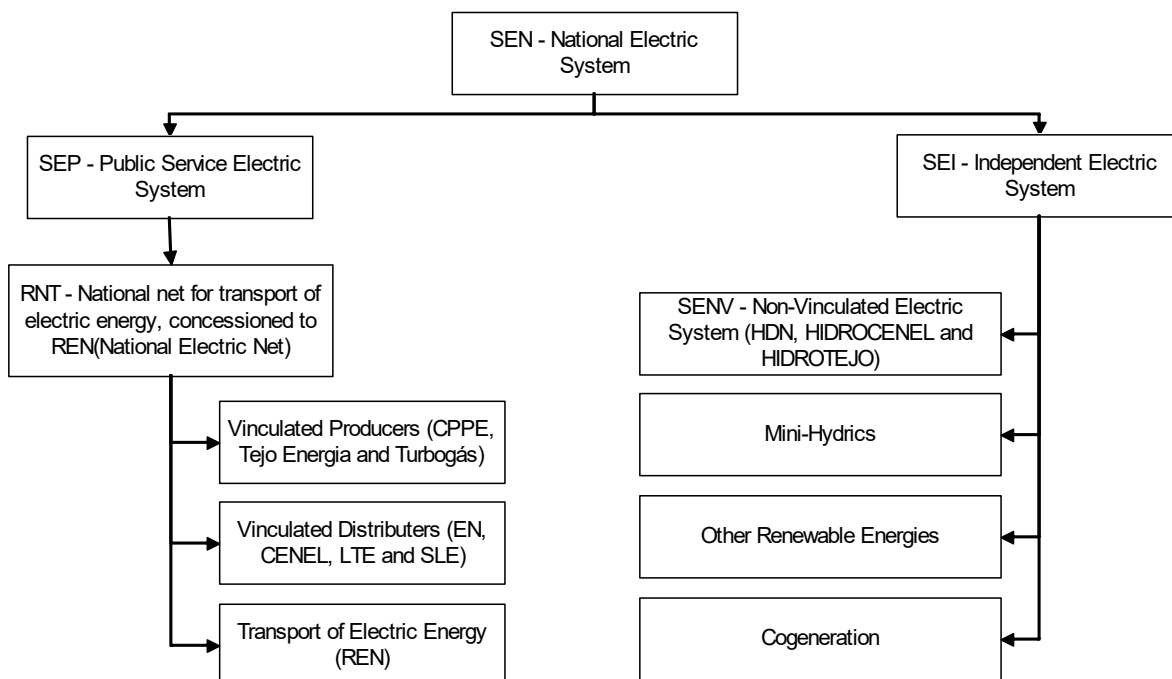

Figure 4-62: Flowchart of the National Electric System

In SEP (Public Service Electric System), “REN (National Electric Net)” is responsible for electricity distribution at Very High Voltage (>110 kV), “EDP Distribuição” is responsible for distribution at Low (≤1 kV), Medium (>1 kV and ≤45 kV) and High Voltage (>45 kV and ≤110 kV) and includes vinculated distributors. “EDP Produção” includes vinculated producers “CPPE” units and great part of SEI (Independent Electric System). “Tejoenergia” and “Turbogás” are SEP (Public Service Electric System) vinculated producers.

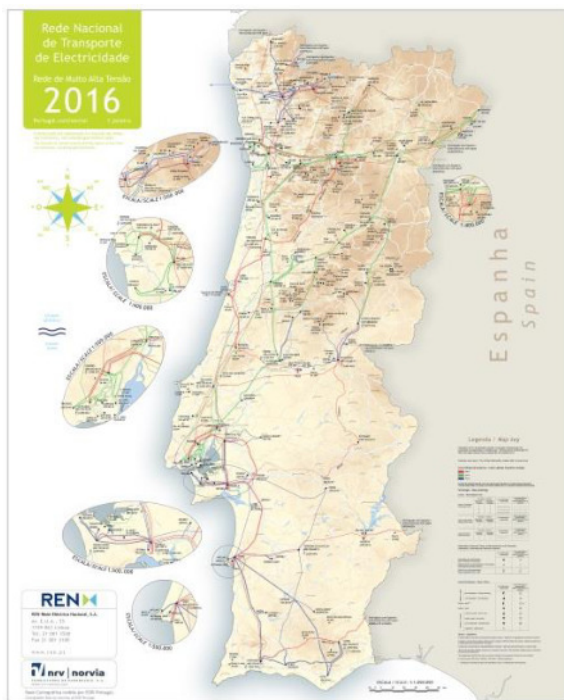

Figure 4-63: Map of National Network of Electric Energy Transport

4.8.3.2 Methodology

There are different estimates methodologies for:

- REN;
- EDP Distribuição, EDP Produção, Tejoenergia and Turbogás;
- Other Companies.

4.8.3.2.1 REN

In this case, a methodology based on “Correspondent States Principle” was used:

Equation 4-73: Correspondent States Principle

$$P \times V = Z \times n \times R \times T$$

$$n_i = \frac{P_i \cdot V}{R \cdot T_i} \cdot \frac{1}{Z_i}$$

$$n_f = \frac{P_f \cdot V}{R \cdot T_f} \cdot \frac{1}{Z_f}$$

$$m = (n_f - n_i) \cdot M$$

Where:

P: Pressure

V: Compartment volume filled with SF₆ inside the equipment

Z: Compressibility factor (obtained from tabled values for Reduced Pressure and Temperature)

n: Mole number of SF₆



R: Gases Constant

T: Temperature

Ti and Pi: Measured Temperature and Pressure at the beginning of reposition of lost SF₆

Tf and Pf: Measured Temperature and Pressure at the end of reposition of lost SF₆

Zi: Compressibility Factor at Pressure Pi and Temperature Ti

Zf: Compressibility Factor at Pressure Pf and Temperature Tf

ni: Mole number of SF₆ at pressure Pi and Tf before the reposition of gas

nf: Mole number of SF₆ at pressure Pf and Tf after the reposition of gas

M: SF₆ molecular mass

m: SF₆ mass emitted

There are two alarm situations that require an intervention and reposition of SF₆:

- Loss of SF₆ slightly above Service Pressure (≈70 % of Maximum Pressure);
- Loss of SF₆ below Service Pressure (<70 % of Maximum Pressure) - in this situation the equipment doesn't work at all.

Besides these two situations there is a team that does regular gas repositions (each 15 days) after temperature and pressure measurements on containers. Each intervention is registered in a database and the equipment used is identified.

4.8.3.2.2 EDP Distribuição

In EDP Distribuição separate estimates were made for:

- Gas Circuit Breakers;
- Outdoor Gas Insulated Switchgears;
- Gas Insulated Switchgears;
- High and Medium Voltage Sectioning Posts.

Actual emissions of SF₆ from electrical equipment were estimated with a Tier 3b, based on data provided by "EDP Distribuição", excluding the details in life-cycle and using a country-specific emission factor.

Emissions were determined using the following equation:

Equation 4-74: SF₆ emissions

$$Em_{SF_6} = Stock_{SF_6} \times (EF/100)$$

Where:

Em_{SF₆}: Equipment use emissions, including leakage emissions, servicing and maintenance (t)

Stock_{SF₆}: Total SF₆ gas in existence at year t in all electrical equipment

EF: Emission Factor, corresponding to the percentage of SF₆ in stock at year t that is emitted to atmosphere



4.8.3.2.3 EDP Produção, Tejoenergia and Turbo gás

The used methodology was identical to the one described for “EDP Distribuição”.

Disposal or retiring units were not included in the inventory as emission sources because, according to industry experts, the collection of gas at end of lifetime is done in a systematic and efficient way. Manufacturing and installation emissions were assumed to be included in emissions from equipment usage.

4.8.3.3 Emission Factors

There are different emission factors for the methodologies described above.

4.8.3.3.1 REN

The database on SF₆ repositions by equipment was available for the period 2003-2010. For the period 1995-2002 and from 2011 onwards, an average of the estimated loss (0.38 %) for the period 2003-2010 was considered.

4.8.3.3.2 EDP Distribuição

In EDP Distribuição different emission factors were considered for:

- Gas Circuit Breakers: all circuit breakers are “Closed Pressure” equipment and the emission factor is 2.6 %/year as proposed on table 8.3 of “2006 IPCC Guidelines for National Greenhouse Gas Inventories” for “Closed Pressure Electrical Equipment”;
- Outdoor Gas Insulated Switchgears: all outdoor gas insulated switchgears are “Sealed Pressure” equipment and the emission factor is 0.2 %/year as proposed on table 8.2 of “2006 IPCC Guidelines for National Greenhouse Gas Inventories” for “Sealed Pressure Electrical Equipment”;
- Gas Insulated Switchgears: it is assumed by EDP expert judgment that 27 % of equipment are “Sealed Pressure” and 73 % are “Closed Pressure”; the emission factors are 0.2 %/year to “Sealed Pressure” as proposed on table 8.2 of “2006 IPCC Guidelines for National Greenhouse Gas Inventories” for “Sealed Pressure Electrical Equipment” and 2.6 %/year to “Closed Pressure” as proposed on table 8.3 of “2006 IPCC Guidelines for National Greenhouse Gas Inventories” for “Closed Pressure Electrical Equipment”;
- High and Medium Voltage Sectioning Posts: all high and medium voltage sectioning posts are “Sealed Pressure” equipment and the emission factor is 0.2 %/year as proposed on table 8.2 of “2006 IPCC Guidelines for National Greenhouse Gas Inventories” for “Sealed Pressure Electrical Equipment”.

4.8.3.3.3 EDP Produção

Different emission factors are used for:

- Sealed Pressure Equipment: emission factor is 0.2 %/year as proposed on table 8.2 of “2006 IPCC Guidelines for National Greenhouse Gas Inventories” for “Sealed Pressure Electrical Equipment”;
- Closed Pressure Equipments: EDP Produção has a database on SF₆ stock amounts in “Closed Pressure” equipments from 2000 onwards. There is no data related to SF₆ stock in the period 1995-1999 and it is used an average emission factor of 0.93 % based on 2000-2006 data period.

4.8.3.3.4 Tejoenergia and Turbo gás

It is assumed by “Tejoenergia” and “Turbogás” expert judgment that all equipment are “Closed Pressure” and that the emission factor is 2.6 %/year as proposed on table 8.3 of “2006 IPCC Guidelines for National Greenhouse Gas Inventories” for “Closed Pressure Electrical Equipment”.



4.8.3.3.5 Other Companies

It is assumed that 50% of the equipment are “Closed Pressure” and 50% are “Sealed Pressure. We use the emission factors proposed on table 8.3 of “2006 IPCC Guidelines for National Greenhouse Gas Inventories” for “Closed Pressure Electrical Equipment” and “Sealed Pressure Equipment”.

4.8.3.4 Activity Data

Although it is not possible to differentiate activity data in this report, the information on the yearly total amount of SF₆ in Electric Equipment is available (see the figure below). From 2013 onwards we started using data reported by companies under the F-Gas Tool (<https://formularios.apambiente.pt/GasesF/>).

Table 4-85: Average SF₆ charge for each kind of equipment

Equipment	SF ₆ (kg)
Gas Circuit Breaker	1.200
Outdoor Gas Insulated Switchgear	0.720
Gas Insulated Switchgear	0.484

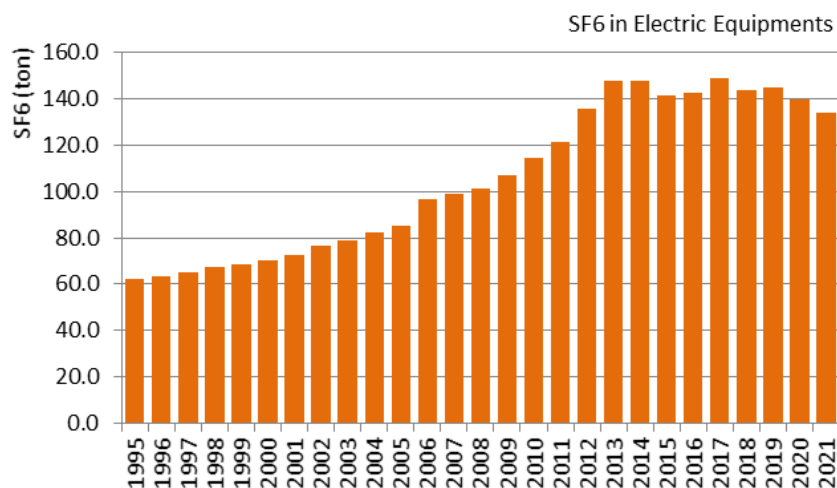

Figure 4-64: Total SF₆ in stock in electric equipment in Portugal

4.8.3.5 Uncertainty Assessment

Table 4-86: Electric Equipment

Parameter	U (%)
AD Combined Uncertainty	10.0%
Manufacture	30.0%
Use (Includes leakage, major failures/arc faults and maintenance losses)	30.0%
Lifetime EF	40.0%
EF Combined Uncertainty	58.3%

4.8.3.6 Category specific QA/QC and verification

QA/QC procedures included a series of checks: calculation formulas verification, data and parameters verification and the information provided in this report.

4.8.3.7 Recalculations

2019 activity data was revised upon contact with an operator. Also, minor recalculations regarding this sub-sector for the whole time series resulted from the adoption of the latest SF₆ GWP according to AR5.



4.8.3.8 Further Improvements

No further improvements are expected.

4.8.4 SF₆ and PFCs from Other Product Use (CRF 2.G.2)

There are no other product uses of SF₆ and PFCs in Portugal.

4.8.5 N₂O from Product Use – Medical Application (CRF 2.G.3.a)

4.8.5.1 Category description

Evaporative emissions of nitrous oxide (N₂O) can arise from various types of product use. In general, medical applications (anaesthesia use, analgesic use and veterinary use) and use as a propellant in aerosol products are likely to be larger sources among others.

4.8.5.2 Methodology

The N₂O consumed in Portugal is primarily for medical use as anaesthesia. According to Chapter 8.4.2.1 of Volume 3 of 2006 IPCC Guidelines, it is good practice to estimate N₂O emissions from data of quantity of N₂O supplied that are obtained from manufacturers and distributors of N₂O products: “There will be a time delay between manufacture, delivery and use but this is probably small in the case of medical applications because hospitals normally receive frequent deliveries to avoid maintaining large stocks. Therefore, it is reasonable to assume that the N₂O products supplied will be used in one year.”

4.8.5.3 Emission Factors

According to Chapter 8.4.2.2 of Volume 3 of 2006 IPCC Guidelines, it is assumed that none of the administered N₂O is chemically changed by the body, and all is returned to the atmosphere. It is reasonable to assume an emission factor of 1.0.

4.8.5.4 Activity Data

Currently, there are 5 companies that commercialize N₂O for medical use as anaesthesia. Consumption of N₂O is provided directly by the companies. This set of activity data includes estimates due to lack of data.

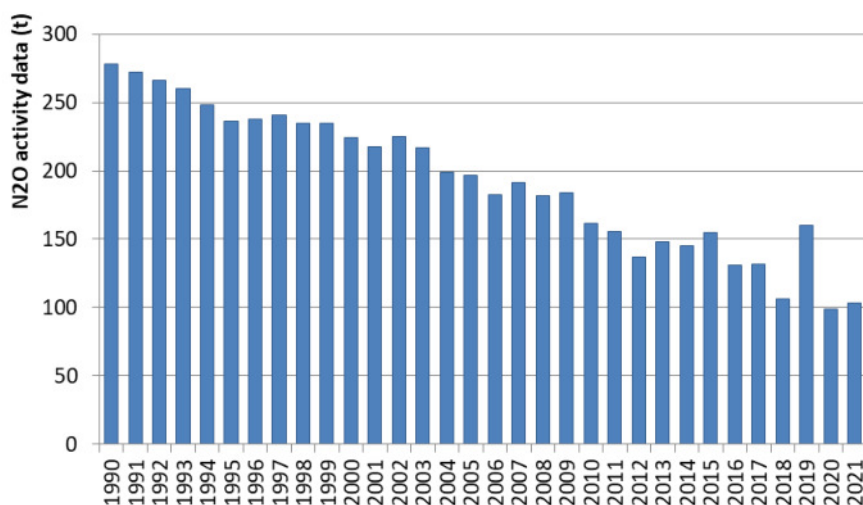

Figure 4-65: N₂O consumption data



4.8.5.5 Uncertainty Assessment

The uncertainty is associated with the activity data which refers to information collected from the 5 producers/importers that commercialize N₂O for medical use as anaesthesia and includes estimates for the previous years. Values considered are: 1990-2000: 25 %; 2001-2007: 10 %; from 2008 onwards: 1 %.

Regarding emission factors, it is assumed that none of the administered N₂O is chemically changed by the body, and that all is returned to the atmosphere (EF = 1.0). For this reason a zero value was considered for the EF uncertainty.

4.8.5.6 Category specific QA/QC and verification

QA/QC procedures included a series of checks: calculation formulas verification, data and parameters verification and the information provided in this report.

4.8.5.7 Recalculations

Minor recalculations regarding this sub-sector for the whole time series resulted from the adoption of the latest N₂O GWP according to AR5.

4.8.5.8 Further Improvements

No further improvements are expected.

4.8.6 N₂O from Product Use – Propellant for pressure and aerosol products (CRF 2.G.3.b)

N₂O is also used as a propellant in aerosol products primarily in food (pressure-packaged whipped cream, etc.).

Portugal considers these emissions as negligible and reports this category as not estimated (NE).

In order to evaluate the order of magnitude of the potential underestimation, the average per capita emissions for several countries (Italy-Spain-France-Austria-Netherlands-Denmark) has been considered as a conservative approach: 1.860 kg/inh/year. Considering the Portuguese population, the estimated emissions for this category are: 1990: 14.9 kt CO₂ eq. 2020: 19.2 kt CO₂ eq. Despite the fact that these estimates are considered to be highly conservative, they are far below (0.028 %) the level of significance (0.05 % of national total emissions). Therefore and for the time being, Portugal considers these emissions as negligible and currently has no plans to estimate these emissions.



4.9 Other (CRF 2.H)

4.9.1 Overview

This chapter is intended to estimate GHG emissions that result from other industrial processes not included in the above addressed categories. In this category, the following activities are reported: pulp and paper production, food and drink manufacturing, wood chipboard production and carbon electrodes consumption.

There are direct CO₂ process emissions from carbon electrodes consumption. There are no direct CO₂, CH₄ and N₂O process emissions from the other activities. There are, however, emissions related to SO_x, NO_x and indirect CO₂ emissions related to NMVOC.

4.9.2 Pulp and Paper Industry (CRF 2.H.1)

4.9.2.1 Category description

In Portugal there were in 1990 six paper pulp plants using the kraft process and two units using the acid sulphide process. Later, in 1993, one of the smaller of the acid sulphide plants was decommissioned and nowadays only 6 plants remain in operation.

Kraft pulping is essentially a digestion process of wood by a solution of sodium sulphide (Na₂S) and sodium hydroxide (NaOH) (white liquor) at elevated temperature and pressure that dissolves lignin and leaves cellulose fibers unbind. Apart from digestion other relevant industrial processes include pulp washing, pulp drying, chemical recovery of reactants (sulphur and quicklime) and possibly bleaching. Recovery of sulphur from the spend cooking liquor and washing water (black liquor) includes combustion in the recovery furnace, after concentration in evaporators, and reaction with water and quicklime of the green liquor in a causticizing tank generating white liquor and lime mud. Quicklime is recovered by combustion in a lime kiln.

Emissions of sulphur compounds, including mercaptans, dimethyl sulphide, dimethyl disulphide and H₂S, occur in digester and blow tank relieves, in evaporators, and in the lime kiln. In the recovery furnace sulphur compounds are oxidized to SO_x, but these are emissions already included in combustion in manufacturing industries (1.A.2 source sector).

Acid sulphide involves also chemical digestion of wood but using SO₂ absorbed in a base solution. Washing, drying and recovery of chemicals are also part of this production process.

Emissions of CO₂, CH₄ and N₂O from combustion equipment of this industry sector were estimated using energy consumption as activity data (energy approach) and were included in combustion in manufacturing industries (1.A.2 source sector).

4.9.2.2 Methodology

SO_x, NO_x and NMVOC process emissions are estimated according to:

Equation 4-75: Emissions from Pulp and Paper Industry

$$Emi_p = EF_{(p)} \times Pulp_{PROD} \times 10^{-3}$$

Where:

Emi_p: Annual emission of pollutant p (t)

EF_(p): Emission factor for pollutant p (kg/t)

Pulp_{PROD}: Annual Paper pulp production (t)



4.9.2.3 Emission Factors

The following emissions factors were used to estimate process emissions, respectively for the Kraft and sulphide process plants. They were set from US-EPA AP42 and other sources and include emissions from:

- Kraft process: Digester, Brown Stock Washers, Black Liquor Evaporators, Non condensable gases, Smelt dissolving tank, Fluid Bed Calciner and Bleaching;
- Acid sulphide: Digester and Blow Pit.

Table 4-87: Emission Factors for paper pulp production (non-combustion)

Process	SO _x	NO _x	NM VOC
Kraft	0.31	1.95	2.74
Sulphide	35.5	NA	NA

4.9.2.4 Activity Data

In the period 1990-2009, production of paper pulp expressed in air dried weight was obtained directly from CELPA (the Portuguese Paper Industry Association). From 2010 onwards, activity data is obtained from EU-ETS. Acid Sulphide production is only a minor component of total production¹⁶ but may not be published individualised due to confidentiality constraints. However, sulphide production¹⁶ is about 5 to 8 % of total paper pulp produced in Portugal, according to years. Paper pulp production has been increasing during the reporting period.

The following figure presents total national production of paper pulp.

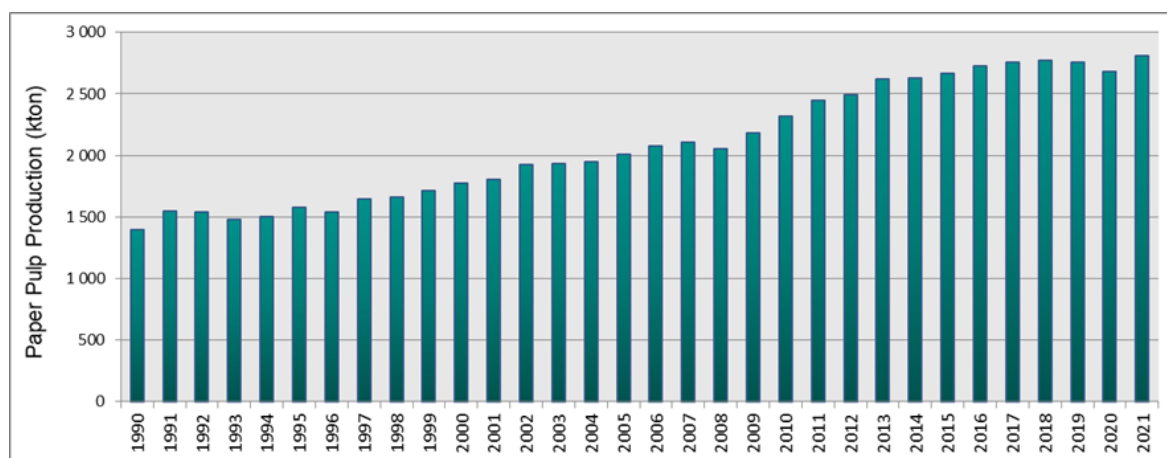

Figure 4-66: Total production of paper pulp

4.9.2.5 Uncertainty Assessment

This information will be provided in future submissions.

4.9.2.6 Category specific QA/QC and verification

QA/QC procedures included a series of checks: calculation formulas verification, data and parameters verification and the information provided in this report.

¹⁶ Specific information for sulphide pulping cannot be delivered because presently there is only one plant operating which raised confidential constraints.



4.9.2.7 Recalculations

No recalculations were made.

4.9.2.8 Further Improvements

No further improvements are planned.

4.9.3 Food Manufacturing (CRF 2.H.2)

There are no direct CO₂, CH₄ and N₂O emissions to report in this subsector in Portugal. There are, however, NMVOC emissions. The methodology used to estimate NMVOC emissions can be checked in the Portugal IIR. Indirect CO₂ emissions related to NMVOC emissions are reported in CRF Table 6.

4.9.4 Drink Manufacturing (CRF 2.H.2)

There are no direct CO₂, CH₄ and N₂O emissions to report in this subsector in Portugal. There are, however, NMVOC emissions. The methodology used to estimate NMVOC emissions can be checked in the Portugal IIR. Indirect CO₂ emissions related to NMVOC emissions are reported in CRF Table 6.

4.9.5 Wood Chipboard Production (CRF 2.H.3.a)

There are no direct CO₂, CH₄ and N₂O emissions to report in this subsector in Portugal. There are, however, NMVOC emissions. The methodology used to estimate NMVOC emissions can be checked in the Portugal IIR. Indirect CO₂ emissions related to NMVOC emissions are reported in CRF Table 6.

4.9.6 Carbon electrodes consumption (CRF 2.H.3.b)

4.9.6.1 Category description

According to national statistics, there is national consumption of carbon electrodes in four distinct activities in Portugal: electric arc furnaces in iron and steel industry, manufacture and repair of rolling stock for railways, manufacture of machinery for the extractive and construction industries and in the repair and maintenance of other transport equipment.

CO₂ emissions from consumption of carbon electrodes in electric arc furnaces in iron and steel industry are estimated and reported in sector 2.C.1, based on a mass balance, in which the carbon contained in the raw materials is accounted for and the carbon contained in the billets is subtracted. In 2.C.1 sector there is a wide range of materials that contain carbon (not just coal electrodes).

Therefore, this category reports CO₂ emissions from the other activities listed above.

4.9.6.2 Methodology

CO₂ emissions are estimated from the quantification of carbon in carbon electrodes, through a mass balance for the quantities of CO₂ that are liberated in the conversion process. Therefore emissions are estimated from consumption of carbon materials according to the following equation:



Equation 4-76: CO₂ emissions

$$Emi_{CO_2} = 44/12 \times Carb_{Elect} \times EF \times 10^{-3}$$

Where:

Emi_{CO₂}: CO₂ emissions (kt CO₂)

Carb_{Elect}: Consumption of carbon electrodes (t)

EF: Emission factor (t CO₂/t carbon electrode)

4.9.6.3 Emission Factors

Emission factors of materials consumed in Portugal was set from molecular stoichiometry:

Table 4-88: Emission factors of carbonate materials

Material	EF
Carbon (Electrodes)	3.67

4.9.6.4 Activity Data

From 1996 to 2010, carbon electrodes consumption data was available from national statistics (IAPI/INE). For the period 1990-1995, data has been estimated based on 1996 production data and on GDP for the 1990-1995 period. From 2011 onwards, data has been estimated based on 2010 production data and on GDP for the 2011 onwards.

Final total consumption of carbon electrodes is presented in the figure below.

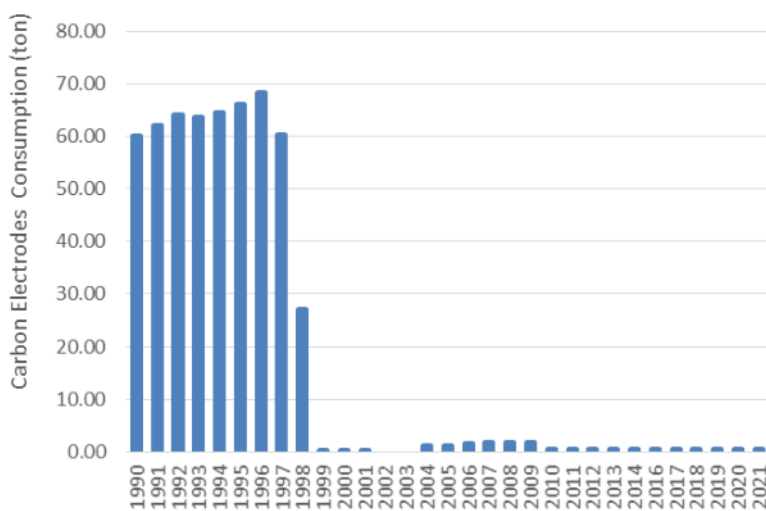

Figure 4-67: Consumption of carbon electrodes in industry

4.9.6.5 Uncertainty Assessment

Table 4-89: Uncertainty values

Parameter	Type of Uncertainty	Uncertainty	Source
Activity Data	Weighing or proportioning materials	2.0% (average of 1.0-3.0% range)	Table 2.3 of "Chapter 2: Mineral Industry Emissions" of "2006 IPCC Guidelines for National Greenhouse Gas Inventories"
Activity Data	Carbon content	2.0%	Table 2.3 of "Chapter 2: Mineral Industry Emissions" of "2006 IPCC Guidelines for National Greenhouse Gas Inventories"
Activity Data	Combined Uncertainty	2.8%	-
CO ₂ EF	Fractional purity	3.0% (average of 1.0-5.0% range)	Average value of the range 1-5% of chapter 2.5.2.1 of Volume 3: Industrial Processes and Product Uses of 2006 IPCC Guidelines for National Greenhouse Gas Inventories.



4.9.6.6 Category specific QA/QC and verification

QA/QC procedures included a series of checks: calculation formulas verification, data and parameters verification and the information provided in this report.

4.9.6.7 Recalculations

No recalculation were made.

4.9.6.8 Further Improvements

Efforts will be made in order to obtain necessary statistical information for the missing years from carbon electrodes consumption.

5 Agriculture (CRF Sector 3)

Table of Contents

5	Agriculture (CRF Sector 3)	5-1
5.1	Overview of the sector	5-9
5.2	CH ₄ Emissions from Enteric Fermentation (CRF 3.A)	5-15
5.2.1	Category description	5-15
5.2.2	Methodological issues	5-16
5.2.3	Emission Factors	5-16
5.2.4	Activity Data	5-27
5.2.5	Uncertainty Assessment	5-31
5.2.6	Category specific QA/QC and verification	5-32
5.2.7	Category specific recalculations	5-33
5.2.8	Category specific planned improvements	5-35
5.3	CH ₄ Emissions from Manure Management (CRF 3.B.a)	5-36
5.3.1	Category description	5-36
5.3.2	Methodological issues	5-37
5.3.3	Emission Factors	5-37
5.3.4	Activity Data	5-44
5.3.5	Uncertainty Assessment	5-44
5.3.6	Category specific QA/QC and verification	5-45
5.3.7	Category specific recalculations	5-45
5.3.8	Category specific planned improvements	5-46
5.4	CH ₄ Emissions from Rice Cultivation (CRF 3.C)	5-46
5.4.1	Category description	5-46
5.4.2	Methodological issues	5-46
5.4.3	Emission Factors	5-47
5.4.4	Activity Data	5-50



5.4.5	Uncertainty Assessment	5-50
5.4.6	Category specific QA/QC and verification	5-50
5.4.7	Category specific recalculations	5-50
5.4.8	Category specific planned improvements	5-51
5.5	N ₂ O Emissions from Manure Management (CRF 3.B.b)	5-51
5.5.1	Direct N ₂ O Emissions from Manure Management	5-52
5.5.2	Indirect N ₂ O Emissions from Manure Management	5-59
5.5.3	Category specific QA/QC and verification	5-60
5.5.4	Category specific recalculations	5-61
5.5.5	Category specific planned improvements	5-61
5.6	N ₂ O Emissions from Managed Soils (CRF 3.D)	5-61
5.6.1	Direct N ₂ O Emissions from Managed Soils	5-62
5.6.2	Indirect N ₂ O Emissions from Managed Soils	5-72
5.6.3	Category specific QA/QC and verification	5-76
5.6.4	Category specific recalculations	5-77
5.6.5	Category specific planned improvements	5-83
5.7	Field Burning of Agriculture Residues (CRF 3.F and CRF 5.C.2)	5-84
5.7.1	Category description	5-84
5.7.2	Methodological issues	5-85
5.7.3	Emission Factors	5-85
5.7.4	Activity Data	5-86
5.7.5	Uncertainty Assessment	5-88
5.7.6	Category specific QA/QC and verification	5-88
5.7.7	Category specific recalculations	5-88
5.7.8	Category specific planned improvements	5-88
5.8	CO ₂ Emissions from Liming (CRF 3.G)	5-89
5.8.1	Category description	5-89
5.8.2	Methodological issues	5-89
5.8.3	Emission Factors	5-89
5.8.4	Activity Data	5-89
5.8.5	Uncertainty Assessment	5-90
5.8.6	Category specific QA/QC and verification	5-90
5.8.7	Category specific recalculations	5-91
5.8.8	Category specific planned improvements	5-91



5.9	CO ₂ Emissions from Urea application (CRF 3.H)	5-91
5.9.1	Category description	5-91
5.9.2	Methodological issues	5-91
5.9.3	Emission Factors	5-91
5.9.4	Activity Data	5-92
5.9.5	Uncertainty Assessment	5-92
5.9.6	Category specific QA/QC and verification	5-92
5.9.7	Category specific recalculations	5-92
5.9.8	Category specific planned improvements	5-93
5.10	CO ₂ Emissions from Other Carbon-containing fertilizers (CRF 3.I)	5-93
5.10.1	Category description	5-93
5.10.2	Methodological issues	5-93
5.10.3	Emission factors	5-96
5.10.4	Activity Data	5-96
5.10.5	Uncertainty Assessment	5-96
5.10.6	Category specific QA/QC and verification	5-97
5.10.7	Category specific recalculations	5-97
5.10.8	Category specific planned improvements	5-97

List of Figures

Figure 5-1: Agricultural emissions from the total greenhouse gas emissions in 2021	5-9
Figure 5-2: Importance of agriculture sub sectors greenhouse gas emissions in 1990 and 2021	5-11
Figure 5-3: Methane emissions from agriculture- trend by source	5-11
Figure 5-4: Nitrous Oxide emissions from agriculture- trend by source	5-12
Figure 5-5: Overview of Methodology	5-13
Figure 5-6: CH ₄ and N ₂ O emissions from agriculture sector, differences between submissions 2022 and 2023	5-14
Figure 5-7: Relative importance of CH ₄ emissions from enteric fermentation per each animal species, in 2021	5-16
Figure 5-8: Evolution pattern growth for sheep (a) and goats (b)	5-28
Figure 5-9: Lambs and Kids: average carcass weight at slaughtering	5-29
Figure 5-10: Livestock numbers: comparison between National Statistics and FAO database	5-33
Figure 5-11: Total enteric fermentation emissions (t CH ₄). Differences between 2022 and 2023 submissions	5-33



Figure 5-12: Differences in Mules & asses livestock numbers between submissions	5-34
Figure 5-13: Differences in Horses livestock numbers between submissions	5-34
Figure 5-14: Differences in Goats livestock numbers between submissions	5-35
Figure 5-15: Differences in Sheep livestock numbers between submissions	5-35
Figure 5-16: Relative importance of CH ₄ emissions from Manure Management per each animal species in 2021	5-36
Figure 5-17: Climate regions presentation	5-41
Figure 5-18: Manure management emissions (t CH ₄), differences between submissions (2022 and 2023)	5-46
Figure 5-19: Rice cultivation relevant practices for EF calculation	5-48
Figure 5-20: Rice area cultivated in Portugal, ha	5-49
Figure 5-21: Rice cultivation emissions (t CH ₄), differences between submissions 2022 and 2023	5-51
Figure 5-22: Rice area with burning restrictions (ha), differences between submissions 2022 and 2023 ..	5-51
Figure 5-23: Direct N ₂ O emissions from manure management, per system, 2021	5-53
Figure 5-24: Direct N ₂ O emissions from manure management by livestock category, 2021	5-53
Figure 5-25: Distribution of total nitrogen in manure produced in 2021 (%)	5-57
Figure 5-26: Origin of total nitrogen in manure produced in 2021, per animal type	5-57
Figure 5-27: Share of nitrogen in manure stored and treated per MMS, in 2021	5-58
Figure 5-28: Origin, by livestock category, of nitrogen in manure stored and treated in 2021	5-58
Figure 5-29: Relative importance of the losses of volatile nitrogen and of leached nitrogen from manure management systems, in 2021	5-59
Figure 5-30: N ₂ O emissions (direct and indirect) from manure management (t N ₂ O). Differences between 2022 and 2023 submissions	5-61
Figure 5-31: Contribution of the various subsources to direct N ₂ O emissions from managed soils, 2021 .	5-63
Figure 5-32: Relevance of the sources of direct input of Nitrogen to agricultural soils in 2021	5-65
Figure 5-33: Use of inorganic N fertilizers (t N.yr ⁻¹)	5-66
Figure 5-34: Application of sewage sludge (t dm) and quantities of N (t N) in agriculture soils	5-68
Figure 5-35: Application of Municipal Solid Waste (MSW) compost (t) and quantities of N (t N) in agriculture soils	5-69
Figure 5-36: Share of indirect N ₂ O emissions from managed soils by pathway: volatilization and leaching/runoff, 2021	5-72
Figure 5-37: Share of indirect N ₂ O emissions from managed soils by source, 2021	5-72
Figure 5-38: Databases comparison of inorganic N fertilizers (t N.yr ⁻¹)	5-77
Figure 5-39: Differences between submissions (2022 and 2023) for total N ₂ O emissions (direct and indirect) from managed soils (t N ₂ O)	5-78
Figure 5-40: Differences in Mules & asses livestock numbers between submissions	5-78
Figure 5-41: Differences in Horses livestock numbers between submissions	5-79



Figure 5-42: Differences in Goats livestock numbers between submissions	5-79
Figure 5-43: Differences in Sheep livestock numbers between submissions	5-80
Figure 5-44: Ammonium Nitrate (AN) consumption (t N)	5-80
Figure 5-45: Ammonium Phosphate consumption (t N)	5-81
Figure 5-46: Ammonium Sulphate consumption (t N)	5-81
Figure 5-47: Calcium Ammonium Nitrate (CAN) consumption (t N)	5-82
Figure 5-48: Urea consumption (t N).....	5-82
Figure 5-49: Other NP & NPK fertilizers consumption (t N)	5-83
Figure 5-50: Other N fertilizers consumption (t N)	5-83
Figure 5-51: Share of GHG emissions from field burning agriculture residues, by crop, 2021	5-85
Figure 5-52: Annual biomass burnt (t dm .yr ⁻¹) for the time series.....	5-87
Figure 5-53: Amount of biomass burnt (kt dm). Differences between 2022 and 2023 submissions.....	5-88
Figure 5-54: CaCO ₃ used on agriculture land (t.yr ⁻¹).....	5-89
Figure 5-55: CaMg(CO ₃) ₂ used on agriculture land (t.yr ⁻¹).....	5-90
Figure 5-56: MgCO ₃ used on agriculture land (t.yr ⁻¹)	5-90
Figure 5-57: CO ₂ emissions differences between 2022 and 2023 submissions (%)	5-91
Figure 5-58: Urea fertilizer application on agriculture land (t. yr ⁻¹)	5-92
Figure 5-59: CO ₂ emissions differences between 2022 and 2023 submissions (%)	5-93
Figure 5-60: Calcium Ammonium Nitrate (CAN) applied to soils and corresponding CaCO ₃ amount	5-96
Figure 5-61: CO ₂ emissions differences between 2022 and 2023 submissions (%)	5-97

List of Tables

Table 5-1: Total Greenhouse Gas Emissions from Agriculture (kt CO ₂ eq)	5-10
Table 5-2: Key categories in Agriculture (CRF 3) and methodologies used in emission estimates.....	5-14
Table 5-3: CH ₄ emissions from enteric fermentation (kt)	5-15
Table 5-4: Country parameters relevant to methane emission factor of dairy cows enteric fermentation	5-18
Table 5-5: Methane emission factor from enteric fermentation – dairy cows	5-18
Table 5-6: Livestock population by age – Non-dairy cattle	5-20
Table 5-7: Parameters used in the determination of Net Energies for non-dairy cattle	5-21
Table 5-8: Parameters used in the determination of Net Energies (non – dairy mother cows)	5-21
Table 5-9: Non-dairy cattle estimated Gross Energy (GE) and CH ₄ Emission Factor (EF) from enteric fermentation	5-21
Table 5-10: Methane implied emission factor (IEF) for non-dairy cattle category in the time series	5-22



Table 5-11: Parameters used in determination of Net Energies for sheep and goats from 1990 to 1998..	5-24
Table 5-12: Parameters used in determination of Net Energies for sheep and goats from 2013 onwards	5-24
Table 5-13: Sheep and goats estimated Gross Energy (GE) and CH ₄ Emission Factor (EF) from enteric fermentation – from 1990 to 1998	5-25
Table 5-14: Sheep and goats estimated Gross Energy (GE) and CH ₄ Emission Factor (EF) from enteric fermentation – from 2013 onwards.....	5-25
Table 5-15: Methane implied emission factor (IEF) for sheep category in the time series	5-25
Table 5-16: Methane implied emission factor (IEF) for goat category in the time series.....	5-25
Table 5-17: Parameters used in determination of Gross Energy (GE) and enteric fermentation methane emission factor for swine and rabbits	5-26
Table 5-18: Parameters used in determination of Gross Energy (GE) – Poultry	5-27
Table 5-19: Livestock population (thousands)	5-30
Table 5-20: Livestock population uncertainty assessment	5-31
Table 5-21: CH ₄ emissions from Manure Management (kt).....	5-36
Table 5-22: Parameters used in the estimates of volatile solids and EF per animal category.....	5-38
Table 5-23: Share (%) of each Manure Management System per animal type in 1990 and 2021.....	5-40
Table 5-24: Share (%) of livestock population in climate cool region (1990 and 2021).....	5-42
Table 5-25: Methane Conversion Factors (MCF), %, for determination of CH ₄ emissions from manure management	5-43
Table 5-26: Manure management CH ₄ Implied Emission Factors (IEF) and comparison with IPCC 2006 default emission factors (kg CH ₄ .hd ⁻¹ .yr ⁻¹)	5-44
Table 5-27: Uncertainty values, in %, of the CH ₄ Emission Factors of the manure management	5-45
Table 5-28: CH ₄ emissions from Rice cultivation.....	5-46
Table 5-29: Parameters and Emission Factors used to calculate CH ₄ emissions from rice paddies in Portugal	5-49
Table 5-30: Uncertainty values (in %) of the Emission Factor of CH ₄ emissions from rice cultivation	5-50
Table 5-31: N ₂ O emissions from manure management (kt)	5-52
Table 5-32: N ₂ O emission factors per manure management system.....	5-54
Table 5-33: Nitrogen excretion rates (N _{ex}) of dairy cows in the time series.....	5-55
Table 5-34: Nitrogen excretion rates (N _{ex}) of non-dairy cattle in the time series	5-55
Table 5-35: Nitrogen excretion rates (N _{ex}) of all livestock other than cattle.....	5-56
Table 5-36: Uncertainty values (in %) of the activity data for N ₂ O emissions from manure management.	5-59
Table 5-37: Amount of N lost due to volatilization (NH ₃ +NO _x) and leaching, during animal housing and manure storage (t N.yr ⁻¹)	5-60
Table 5-38: N ₂ O emissions from managed soils (kt).....	5-61
Table 5-39: Emission factors used to estimate direct N ₂ O emissions from managed soils	5-64



Table 5-40: Total amounts of Nitrogen (t N/yr) added to managed soils. Activity data for direct N ₂ O emissions	5-64
Table 5-41: Rice cultivation- Nitrogen amount applied on flooded rice fields (t N/yr).....	5-66
Table 5-42: Average amount of straw used in animal bedding-solid manure management systems and N content of straw	5-67
Table 5-43: Estimates of manure management nitrogen available for application to soils (t N.yr ⁻¹)	5-67
Table 5-44: Estimates of annual amounts of nitrogen sewage sludge in agriculture soils	5-68
Table 5-45: Parameters used to estimate nitrogen from crop residues to soil	5-70
Table 5-46: Crop Yield Fresh (kg.ha ⁻¹).....	5-71
Table 5-47: Annual N amounts (t) that volatilized as NH ₃ and NO _x , disaggregated by source input	5-74
Table 5-48: Fra _{C_{GAS}F} and Fra _{C_{GAS}M} annual values.....	5-74
Table 5-49: Emission factor used for calculation of indirect N ₂ O emissions from managed soils	5-76
Table 5-50: Uncertainty values (%) of the fractions of N volatilized and N leached/runoff and of the emission factors.....	5-76
Table 5-51: CH ₄ and N ₂ O emissions estimates from field burning of agriculture residues (kt)	5-84
Table 5-52: Emission factors for field burning agriculture residues, g. kg dm burnt ⁻¹	5-86
Table 5-53: Activity data and parameters used to estimate emissions from field burning of crop residues, 2021	5-87
Table 5-54: Uncertainty values (in %) of the activity data for on field burning crop residues.....	5-88
Table 5-55: Uncertainty values (in %) of the emission factors, CH ₄ and N ₂ O, for on field burning crop residues	5-88
Table 5-56: Molar Mass of Ca, C, O, CaCO ₃ and CO ₂	5-96

List of Equations

Equation 5-1: Enteric fermentation emissions from a livestock category and sub categories	5-16
Equation 5-2: CH ₄ emission factor for enteric fermentation from a livestock category	5-17
Equation 5-3: Swines estimated Gross Energy (GE)	5-26
Equation 5-4: Poultry estimated Gross Energy (GE).....	5-27
Equation 5-5: CH ₄ emissions from Manure Management	5-37
Equation 5-6: CH ₄ emission factor from Manure Management	5-37
Equation 5-7: Volatile solid excretion rates	5-38
Equation 5-8: CH ₄ emissions from Rice cultivation	5-47
Equation 5-9: Emission factor, seasonally integrated and adjusted, for rice cultivation.....	5-47
Equation 5-10: N ₂ O direct emissions from manure management, per system	5-53
Equation 5-11: Direct N ₂ O emissions from managed soils	5-63



Equation 5-12: Annual Consumption of inorganic N fertilizers.....	5-65
Equation 5-13: N ₂ O from atmospheric deposition of N volatilized from managed soils	5-73
Equation 5-14: N ₂ O emissions from leaching/runoff from managed soils.....	5-75
Equation 5-15: Estimation of GHG emissions from field burning of crop residues.....	5-85



5 Agriculture (CRF Sector 3)

Tiago Seabra

Updated: March 2023

5.1 Overview of the sector

Agriculture activities generate emissions of greenhouse gas from a variety of sources. This chapter refers to the quantification of: CH₄ emissions from enteric fermentation (3.A); CH₄ and N₂O emissions from manure management (3.B); N₂O emissions from agriculture soils (3.D); CH₄ from rice cultivation (3.C); CH₄ and N₂O emissions from field burning of agriculture residues (3.F) and CO₂ from liming, urea application and other carbon containing fertilizers (3.G-H-I). There are no ecosystems in Portugal that could be considered natural savannahs and no greenhouse gas emissions exist therefore for this sub-category (3.E). GHG emissions from combustion processes in agriculture are discussed in sector Energy: Other sectors (1A4). Estimates of CO₂ release and uptake resulting from conversion of agriculture land and grazing land to other uses, conversion of other uses to agriculture land and grazing land, conversion of agriculture land to grazing land and vice versa, and substantial changes in agriculture practices, such as conversion of annual crops to perennial crops and the opposite, are estimated in the inventory but included in chapter Land Use, Land Use Change and Forestry (LULUCF).

The importance of agriculture greenhouse gas emissions to total national emissions (excluding LULUCF and international bunkers) has increased from 12.5% in 1990 to 13.0% in 2021.

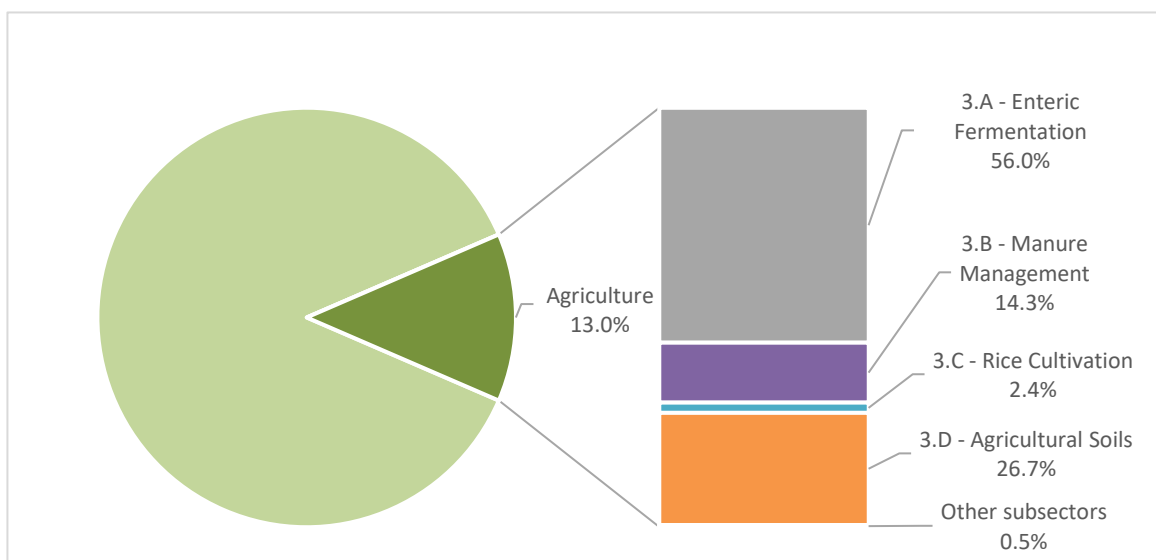

Figure 5-1: Agricultural emissions from the total greenhouse gas emissions in 2021

Total greenhouse gas emissions from agriculture sector have decreased by about 1.1% over the period 1990 to 2021, but have an increase from 2005 to 2021 by about 4.7% (Table 5-1). The decrease of 0.2% in the total agriculture emissions between 2020 and 2021 is mainly due to:

- a decrease in the application of synthetic fertilizers (CRF 3D);
- a decrease in the application of sewage sludge (CRF 3D);
- a decrease in the application of Municipal Solid Waste compost (CRF 3D);
- a decrease in the application of Limestone and Dolomite (CRF 3G);
- a decrease in the application of Urea (CRF 3H);
- a decrease in the application of other carbon containing fertilizers (CRF 3I).



Table 5-1: Total Greenhouse Gas Emissions from Agriculture (kt CO₂eq)

Source /Gas	1990	2005	2019	2020	2021	Δ	Δ	Δ
	kt CO ₂ eq.					2021-2020	2021-2005	2021-1990
						%		
3.A Enteric Fermentation								
CH ₄	3 942.6	3 968.4	4 030.0	4 054.8	4 063.9	0.2	2.4	3.1
3.B Manure Management								
CH ₄	907.4	781.4	826.4	836.7	838.3	0.2	7.3	-7.6
N ₂ O	238.8	183.3	189.6	197.7	201.3	1.8	9.8	-15.7
3.C Rice Cultivation								
CH ₄	150.0	131.0	160.6	133.4	175.8	31.8	34.2	17.2
3.D Agricultural Soils Management								
N ₂ O	2 039.2	1 817.8	1 991.6	1 997.9	1 939.0	-3.0	6.7	-4.9
3.F Field Burning of crop residues								
CH ₄	10.3	7.3	7.2	6.6	7.1	7.2	-2.0	-30.6
N ₂ O	2.5	1.8	1.8	1.6	1.7	7.2	-2.0	-30.6
3.G Liming								
CO ₂	6.5	6.2	10.5	11.8	9.2	-22.2	47.3	41.0
3.H Urea Application								
CO ₂	21.3	18.9	22.1	22.1	16.3	-26.5	-13.9	-23.5
3.I Other Carbon containing fertilizers								
CO ₂	20.7	13.2	8.9	9.2	5.6	-38.7	-57.6	-72.9
Total CH ₄	5 010.2	4 888.0	5 024.2	5 031.6	5 085.1	1.1	4.0	1.5
Total N ₂ O	2 280.5	2 002.9	2 183.0	2 197.2	2 142.0	-2.5	6.9	-6.1
Total CO ₂	48.4	38.3	41.5	43.0	31.0	-27.9	-19.0	-35.9
Total All gases	7 339.2	6 929.3	7 248.6	7 271.9	7 258.2	-0.2	4.7	-1.1

Note: Totals may not sum due to independent rounding. Emissions values are presented in CO₂eq mass units using IPCC AR4 GWP values (CH₄ - 25; NO - 298).

In 2021, the contribution of each greenhouse gas emissions in the total emissions from agriculture, expressed in CO₂eq, is: CH₄ emissions 70.1% (68.3% in 1990); N₂O emissions 29.5% (31.1% in 1990) and CO₂ emissions 0.4% (0.7% in 1990).

The majority of emissions from agriculture in 1990 and 2021 are the result of three main 3 subsources (Figure 5-2): Enteric Fermentation (3.A), Agriculture Soils (3.D) and Manure Management (3.B), hierarchically listed in order of the most prevalent. Rice cultivation (3.C), Field burning of crop residues (3.F) and Liming (3.G), Urea application (3.H) and Other carbon-containing fertilizers (3.I) are minor subsources.

Rounded values are often used in this inventory report, the accurate figures used in the calculation are in the CRF tables.

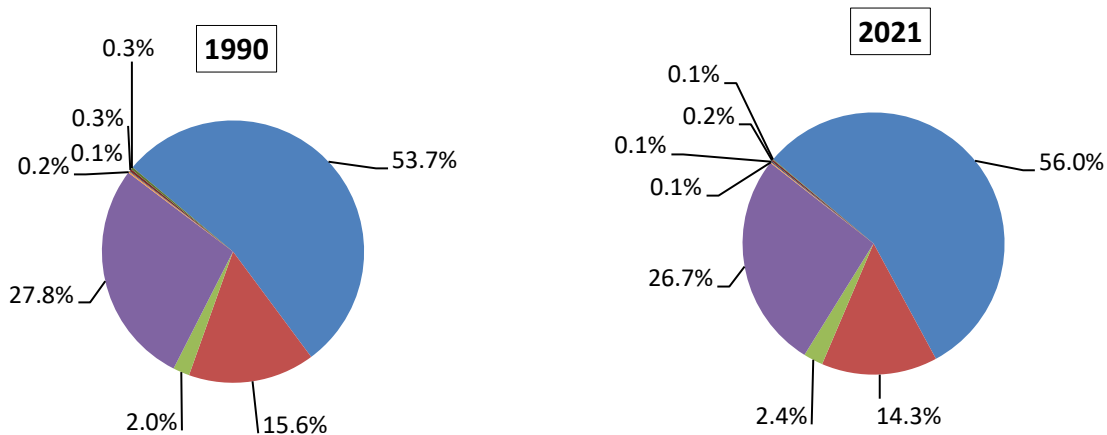

- 3.A - Enteric Fermentation
- 3.B - Manure Management
- 3.C - Rice Cultivation
- 3.D - Agricultural Soils
- 3.E - Prescribed Burning of Savannas
- 3.F - Field Burning of Agricultural Residues
- 3.G - Liming
- 3.H - Urea application
- 3.I - Other carbon-containing fertilizers
- 3.J - Other

Figure 5-2: Importance of agriculture sub sectors greenhouse gas emissions in 1990 and 2021

Annual emissions of CH₄ from agriculture have increased (0.43 %) from 1990 to 2021 (Figure 5-3). The Enteric Fermentation (3.A) was responsible, in 2021, for 79.9% of the sectoral methane emissions and Manure Management (3.B) accounted for 16.5% of the sectoral emissions in the same year. The remaining 3.5% of emissions result mainly from Rice Cultivation (3.C), with only a very small contribution from Field Burning of Crop Residues (3.F), 0.1%.

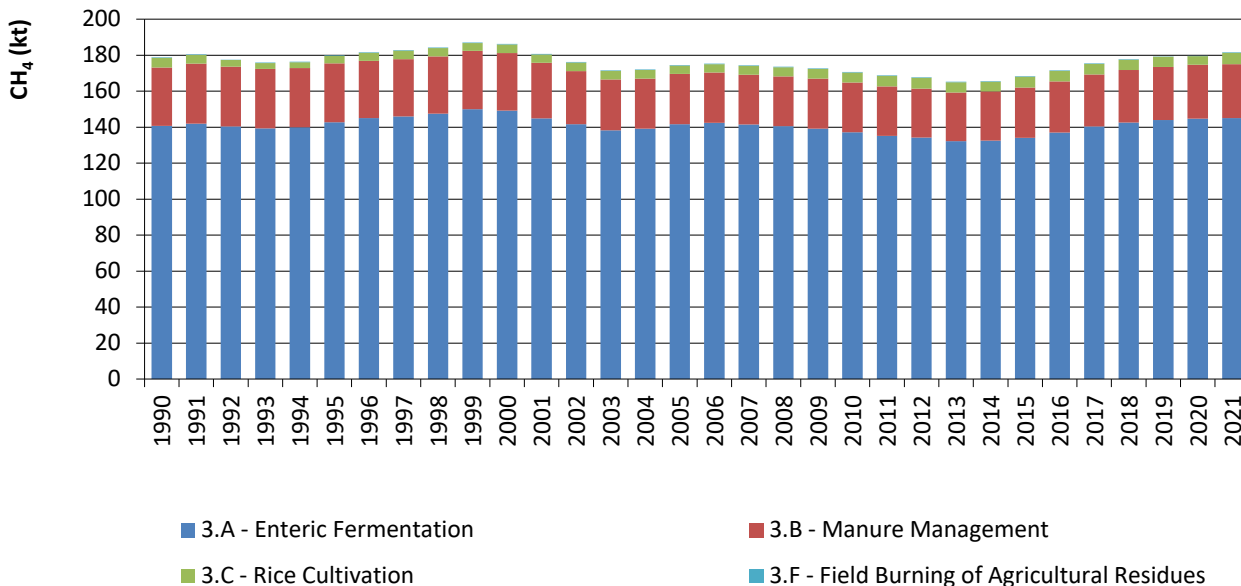

Figure 5-3: Methane emissions from agriculture - trend by source

N₂O emissions have decreased (-3.7%) from 1990 to 2021 (Figure 5-4). The great majority of emissions in 2021 were associated with direct and indirect emissions from Agricultural Soils (3.D), 90.5%, Manure Management (3.B) is responsible for 9.4% of emissions, while the small remaining fraction results from Field Burning of agricultural crop residues (3.F), 0.1%.

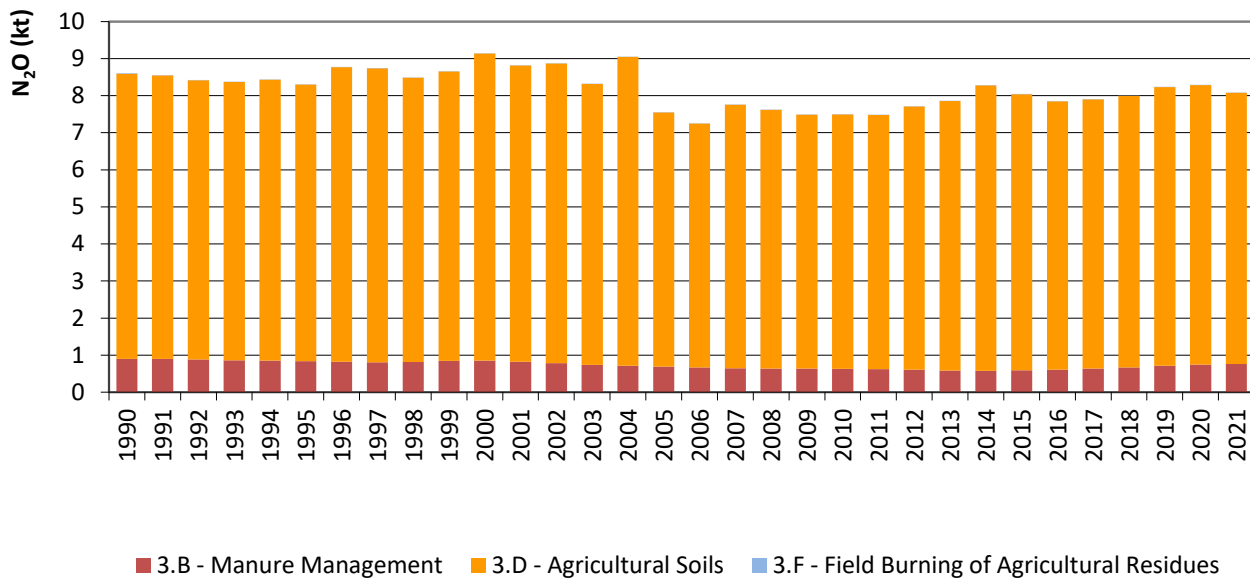

Figure 5-4: Nitrous Oxide emissions from agriculture- trend by source

CO₂ emissions from Liming, Urea application and Other carbon-containing fertilizers are minor sources on total agricultural emissions. Nevertheless, over the period 1990 to 2021, emissions from these source categories have decreased about 35.9%. Urea application is the main source with a share of about 52.4% in 2021.

Some inter annual variation in the time series are mainly caused by fluctuations in activity data due to changes in animal numbers and in the areas/yields of cultivated/harvested crops. Changes in animal numbers are normally linked to agricultural policy and subsidies. Depending on animal species, variations of livestock population affect the enteric fermentation (CH₄) and the manure management (CH₄ and N₂O) emissions, as well as the managed soils (N₂O) emissions subsources urine and dung deposited by grazing animals. Changes in the areas and yields of cultivated crops depends on many factors, for example the climatic conditions occurring during the year, especially in the sowing period and/or the harvest time, the fluctuation of internal and world market prices, among others. The amount of synthetic fertilizers annually used is closely related to the cultivated crops variation. Synthetic fertilizers applied to soils is one of the main subsources of N₂O emissions from managed soils.

Emissions were estimated following as far as possible the methodology recommended by IPCC 2006 Guidelines for National Greenhouse Gas Inventories (IPCC 2006) and were done in a consistent way: the same activity data is used and balanced for all source categories. A general overview of methodology is presented in the next Figure.

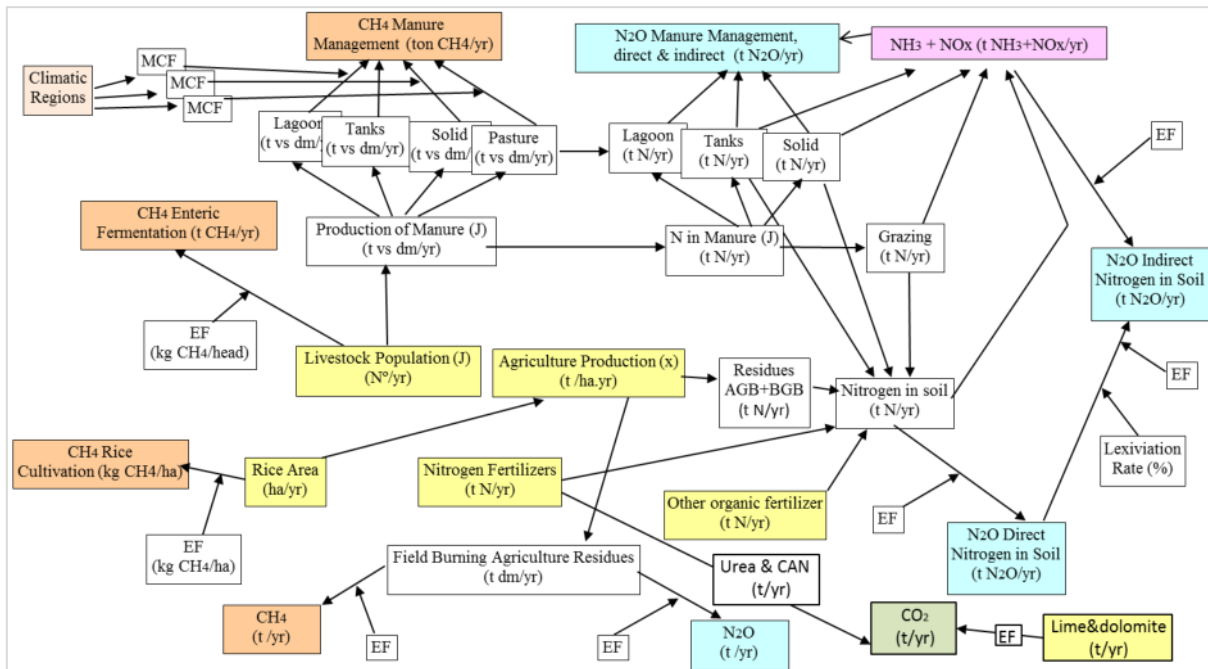

Figure 5-5: Overview of Methodology

This integration of calculus means that changes in methodology are done also in a consistent and coherent way among the several source sectors. Improvements in methodology in each source sector are reflected in changes in other related sources.

Recalculations

Changes from previous submission (2022) and this year submission (2023) are due to the:

- Revision of National Statistics on Mules and Asses livestock numbers from 2002 onwards (increase in the period 2002-2010 and a decrease in the period 2011-2020);
- Revision of National Statistics on Horses livestock numbers from 2003 onwards (increase);
- Revision of National Statistics on Goats livestock numbers from 2016 onwards (increase);
- Revision of National Statistics on Sheep livestock numbers from 2017 onwards (increase);
- Update in Ammonium Nitrate consumption National Statistics from 2019 onwards (increase of 4499% in 2019 and a decrease of 0.5% in 2020);
- Decrease of 52.9% in Ammonium Phosphate National Statistics in 2020;
- Increase of 58.3% in Ammonium Sulphate National Statistics in 2020;
- Decrease of 0.36% in “Other NP & NPK” fertilizers consumption National Statistics in 2020;
- Decrease of 0.34% in “Other N” fertilizers consumption National Statistics in 2020;
- National statistics updates on Biomass Burnt (increase in the period 2003-2008 and decrease in the period 2015-2020);
- Revision of liming subsector activity data (lime production, imports and exports);
- Decrease of 8.5% in Urea consumption National Statistics in 2020;
- Update in Calcium Ammonium Nitrate (CAN) fertilizers consumption National Statistics from 1995 onwards;
- Other minor corrections were done as a result of internal QA/QC procedures which had no significant impact.



The differences between submissions are graphically represented in the next two figures for the total methane emissions and for the total nitrous oxide emissions from agriculture sector.

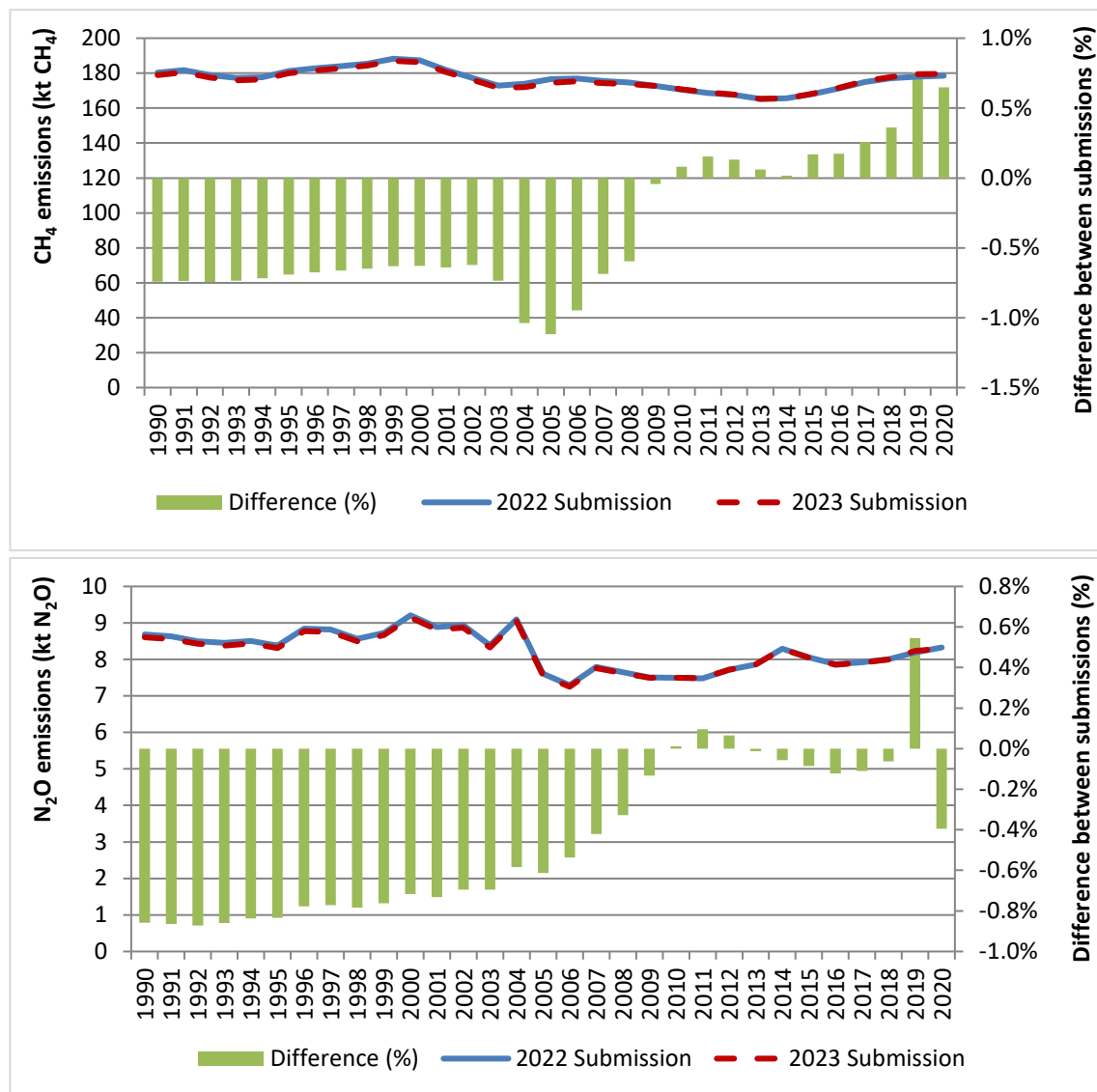

Figure 5-6: CH₄ and N₂O emissions from agriculture sector, differences between submissions 2022 and 2023

Key categories

The key categories in agriculture are summarised in Table 5-2.

Table 5-2: Key categories in Agriculture (CRF 3) and methodologies used in emission estimates

IPCC category	Gas	Criteria	Method
3.A Enteric Fermentation	CH ₄	Level 1, Trend 1	T2
3.D.1 Direct N ₂ O emissions from Managed Soils	N ₂ O	Level 1, Level 2	T1"
3.B Manure Management	CH ₄	Level 1	T2
3.D.2 Indirect N ₂ O emissions from Managed Soils	N ₂ O	Level 1	T1"
3.C Rice Cultivation	CH ₄	Level 2	T1"
"Default EFs but country specific AD & parameters			



5.2 CH₄ Emissions from Enteric Fermentation (CRF 3.A)

5.2.1 Category description

Methane emissions from enteric fermentation in animals result from this gas being produced as a by-product during the digestive process of carbohydrates by micro-organisms in the digestive system. This process occurs specially in ruminant animals (cattle, sheep, goats), due to the activity of specific micro-organisms in their upper digestive tracts, but also in smaller quantities in monogastric animals (swine, equines, poultry and rabbits). The estimates in this inventory include only emissions in domestic animals. Emissions from wild animals and semi-domesticated game are not quantified neither there is quantification of emissions from humans or pet animals.

In Table 5-3 are presented the estimates of CH₄ emission from enteric fermentation.

Table 5-3: CH₄ emissions from enteric fermentation (kt)

Livestock type	1990	1995	2000	2005	2010	2015	2019	2020	2021
Dairy cattle	38.19	37.34	39.95	35.57	32.71	31.05	31.61	31.58	31.45
Non-dairy cattle	60.19	61.39	66.30	71.14	73.36	75.23	82.50	83.17	83.41
Sheep	31.75	34.05	33.86	27.23	23.21	20.40	22.17	22.45	22.73
Swine	5.69	4.93	4.51	3.71	3.62	3.43	3.50	3.39	3.30
Goats	0.59	0.86	1.05	1.08	1.66	1.40	1.48	1.52	1.57
Horses	1.18	1.03	0.69	0.60	0.24	0.11	0.09	0.09	0.09
Mules and asses	3.09	3.07	2.79	2.32	2.31	2.47	2.54	2.57	2.56
Rabbits	0.13	0.11	0.09	0.08	0.07	0.04	0.04	0.04	0.04
Total	140.81	142.78	149.22	141.73	137.18	134.13	143.93	144.81	145.14

Note: Totals may not sum due to independent rounding

CH₄ emissions from enteric fermentation are a key source, both by level and trend assessment. The share of each animal type is observable in Figure 5-7. Dairy cattle and non-dairy cattle are significant sources: dairy cattle represent, according to different years, 21.7% to 27.1% of total CH₄ emissions from Enteric Fermentation, while non-dairy cattle represent about 42.7% to 57.5% of total CH₄ from enteric fermentation. Together, in 2021, cattle were responsible for about 79.1% of total CH₄ emissions from enteric fermentation.

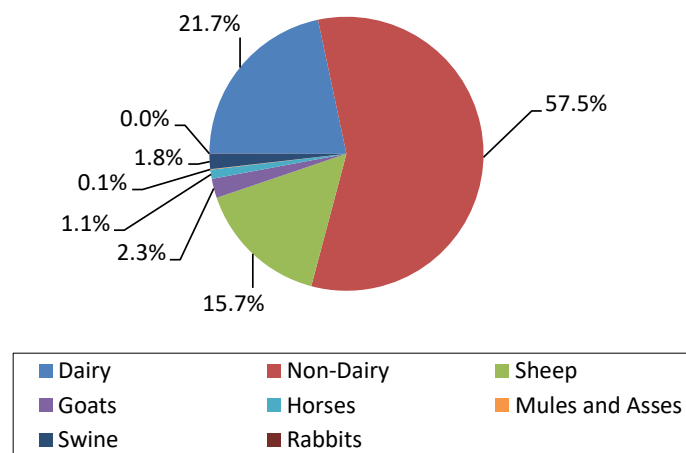

Figure 5-7: Relative importance of CH₄ emissions from enteric fermentation per each animal species, in 2021

Sheep category is also an important source of methane which emissions oscillating in the time series from 15.2% to 24.0% of the total CH₄ emissions from enteric fermentation. Emissions associated to goats have a variation from 2.3% to 4.0 % and the variation of the emissions associated to swine was from 1.6% to 2.3% of the total enteric fermentation emissions. All other animal categories are minor source of methane emissions from enteric fermentation representing in the time series between 1.0% and 1.5%.

5.2.2 Methodological issues

Emissions were estimated for each animal type¹ by multiplication of the number of animals by the respective emission factor, in accordance to equation 10.19 and 10.20² of the IPCC 2006.

Equation 5-1: Enteric fermentation emissions from a livestock category and sub categories

$$Emi_{CH_4(y)} = \sum_t [EF_{(i,y)} * N_{(i,y)}]$$

Where:

$Emi_{CH_4(y)}$ - methane emissions from enteric fermentation in year y, kg CH₄.year⁻¹

$EF_{(i,y)}$ - emission factor for the specific population of animal type i in year y, kg.head⁻¹.year⁻¹

$N_{(i,y)}$ - number of animals of type i in year y

5.2.3 Emission Factors

For cattle (dairy and non-dairy), sheep, goats and swine categories the emission factors used, by animal type and subcategory, were calculated using a methodology level Tier 2. Methodological approach will be further discussed ahead for each one.

The default emission factors proposed by IPCC 2006 in table 10.10³ were maintained for horses, mules and asses, due to the unavailability of a more detailed livestock characterization.

¹ For most animal types an enhanced characterization of livestock, with subdivision per age, sex and management conditions was used. This is discussed in more detail under activity data chapter.

² Volume 4, chapter 10, page 10.28

³ Volume 4, chapter 10, page 10.28



There are no emissions factors in IPCC 2006 for broilers, laying hens, turkeys, ducks, geese and other poultry, thus the emissions from these livestock categories were not estimated and were assumed as negligible. In Portugal, there are no livestock populations of Buffalo, Camels or Lamas.

Determination of Tier 2 emission factors

For the most significant animal types, a tier 2 analysis was implemented to establish the respective emission factors for the enteric fermentation.

According to the IPCC 2006, at Tier 2 level, the emission factors for enteric fermentation are developed following the equation 10.21⁴, described below:

Equation 5-2: CH₄ emission factor for enteric fermentation from a livestock category

$$EF_{CH_4} = \{[GE * (Y_m/100) * 365 \text{ days}] / 55.65\}$$

Where:

EF_{CH₄} – emission factor, kg CH₄ .head⁻¹ year⁻¹

GE – gross energy intake, MJ.head⁻¹.day⁻¹

Y_m – methane conversion factor (% of gross energy in feed that is converted to methane)

The factor 55.65 (MJ.kg⁻¹CH₄) is the energy content of methane

5.2.3.1 Dairy Cattle

For dairy cattle and to the Gross Energy (GE) estimation, two country regions were considered separate, due to differences on feed situation, diet characteristics and milk production. In Portugal Mainland, dairy cows are predominantly stalled with a feed diet based on maize silage (40%) and hay/straw (10%) as raw feed and compound feed (50%). In Azores archipelago dairy cows diet are based on pasture, maize or grass silage and compound feed, being the ratio pasture and, or silage/compound feed about 65/35. Feed digestibility (DE%) of these two different dairy cows feed diets was estimated by experts⁵ of the National Institute for Agriculture and Veterinary Research (INIAV) based on available feed tables data: 74% for mainland region and 71% for Azores.

Milk production (kg.hd⁻¹.d⁻¹) was estimated dividing the annual production over the number of cows in production⁶ and 365 days. Therefore, lactating and non-lactating periods are included in the estimation of the CH₄ dairy cattle emission factor.

Livestock numbers, annual milk production and fat content of milk are published by National Statistical Institute (INE) disaggregated by region.

The majority of cows used for milk production in Portugal belong to the Frisians race. The average weight of 600 kg for mature Frisian cows was supplied by experts⁷ of the General Directorate for Food and Veterinary (DGAV) of Ministry of Agriculture (MA), based on the analysis of the available national information and international studies.

The fraction of cows giving birth annually, disaggregated by region, was estimated from available data (1999–2021) of National Animal Registration (SNIRA)⁸. For the period 1990–1998 data were completed through a linear regression developed by the Statistics Unit (DSE) of GPP (MAM).

⁴ Volume 4, chapter 10, page 10.31

⁵ Dr^a Olga Moreira e Eng^a Teresa Dentinho - Unit of Animal Production and Health, 2014

⁶ The same time series used in the inventory but not averaged over 3 years.

⁷ Dr Vicente de Almeida - Animal Genetic Resources Department ; Dr José Neves – Unit of Animal Identification, Registration and Movement, 2014

⁸ Provided by Funding Institute for Agriculture and Fisheries (IFAP)



Table 5-4 presents the time series (1990-2021) for the relevant country specific parameters used to estimated CH₄ dairy cow emissions from enteric fermentation.

Table 5-4: Country parameters⁹ relevant to methane emission factor of dairy cows enteric fermentation

Year	Average weight (kg hd ⁻¹)	Average milk production (kg hd ⁻¹ d ⁻¹)	Fat content in milk (%)	Cows giving birth in the year (%)	Cows with predominance of pasture on diet (%)
1990	600	12.23	3.96	75.03	22.87
1995	600	12.48	3.91	74.80	23.90
2000	600	17.16	3.86	75.16	27.95
2005	600	19.82	3.84	74.94	30.92
2010	600	21.61	3.78	74.16	34.32
2015	600	22.70	3.76	76.68	37.25
2019	600	23.13	3.80	75.71	37.88
2020	600	23.48	3.77	78.79	38.18
2021	600	23.68	3.77	81.97	37.87

The improvement in breeding conditions and of the technological development of dairy farms led to a general increase in milk yield in the overall period.

Table 5-5 shows the time series for the different Net Energies required for maintenance, animal activity, lactation, pregnancy, growth and work (NE_m, NE_a, NE_l, NE_p, NE_g, NE_{work}), the results for Gross Energy (Mj d⁻¹) and the estimated CH₄ Emission Factor (kg CH₄ hd⁻¹ yr⁻¹) from dairy cows enteric fermentation, which were calculated based on the equations described in IPCC 2006¹⁰ (Net energies equations 10.3, 10.4, 10.8, 10.13, 10.6, 10.11 and Gross energy equation 10.16 which includes equation 10.14 for REM fraction calculation).

A constant methane conversion factor of 6.5% (IPCC 2006 value from table 10.12) of gross energy intake was applied.

Table 5-5: Methane emission factor from enteric fermentation – dairy cows

Year	NE _m	NE _a	NE _g ¹	NE _l	NE _w	NE _p	REM	GE (Mj hd ⁻¹ d ⁻¹)	EF (kg CH ₄ hd ⁻¹ yr ⁻¹)
1990	46.80	1.82	0.00	37.35	0.00	3.53	0.54	227.17	96.99
1995	46.80	1.90	0.00	37.89	0.00	3.51	0.54	228.67	97.73
2000	46.80	2.22	0.00	51.80	0.00	3.52	0.54	265.49	113.34
2005	46.80	2.46	0.00	60.37	0.00	3.49	0.54	288.06	122.89
2010	46.80	2.73	0.00	65.33	0.00	3.46	0.54	300.87	128.77
2015	46.80	2.96	0.00	67.49	0.00	3.59	0.54	309.45	131.80
2019	46.80	3.01	0.00	69.62	0.00	3.56	0.54	315.11	134.20
2020	46.80	3.04	0.00	70.21	0.00	3.70	0.54	317.43	135.02
2021	46.80	3.01	0.00	70.10	0.00	3.81	0.54	317.96	135.06

¹ assumed no gain weight as definition of dairy cows category are mature cows

For the year 2021 the estimated EF is 135.06 kg CH₄ hd⁻¹ yr⁻¹ which is higher than the default value¹¹ (128 kg CH₄ hd⁻¹ yr⁻¹) but not so different. Milk production in Portugal (more than 8000 kg/head/year) exceeds the value indicated for Western Europe and is much higher than the one indicated for Eastern Europe (2550 kg/head/year), but is closer to that of North America (8400 kg/head/year). Therefore, Portugal Inventory Team used for the comparison the default IPCC EF for North America (128 kg CH₄/head/year) instead of the value for Western Europe (117 kg CH₄/head/year) or Eastern Europe (99 kg CH₄/head/year) (2006 IPCC Guidelines, vol. 4, chap. 10, table 10.11).

⁹ Weighted average

¹⁰ Volume 4, Chapter 10

¹¹ The average dairy cow's milk production in Portugal (8600 kg.hd-1 yr-1) is closer to the average milk production in North America (8400 kg.hd-1 yr-1) than to the average milk production in Western Europe (6000 kg.hd-1 yr-1). The default IPCC value for North America is 128 kg CH₄ hd⁻¹ yr⁻¹ and that is the reason to indicate this value instead of the 117 kg CH₄ hd⁻¹ yr⁻¹ for Western Europe.



5.2.3.2 Non - dairy Cattle

The Ministry of Agriculture (MA¹²) compiled in 1998, information from the existing breeder associations in Portugal. This database comprehending: number of registered producers, number of animals, main productive function (milk, meat), weaning age, slaughtering, use as working animal, territorial range and biometric parameters such as weight at the birth, at 7 months and at adult age. The majority of breeds in the 1998 database are indigenous breeds, with two being exotic breeds¹³.

The updating of the 1998 database information, was carried out from 2017 to the middle of 2019, through a work developed with the involvement of the Breeders Associations of the most representative breeds used in Portugal and of the experts on Nutrition and Animal Production and on Chemical and Nutritive Evaluation of Animal Feed, from the National Institute for Agriculture and Veterinary Research (INIAV)¹⁴ and from the University of Évora (UEvora)¹⁵. Of the work developed¹⁶ we highlighted the following updates and sources:

- Through the National Animal Registration database (SNIRA) it was possible to obtain the latest information about the composition of the non-dairy cattle population from 2013¹⁷ to 2017, i.e: the most representative purebreds (10 indigenous and 3 exotics)¹⁸ and, also, the proportion and the territorial distribution of pure and of crossbred animals;
- For each purebred, an update of animal characteristics was collected from the breeder Associations through a specific survey, providing relevant information, such as: live-weights of males and females at different stages of growth (birth, 4 months, 7 months, 12 months, 24 months and adult age), average weight gains per day, feeding practises and type of animal management;
- The characterization of crossbred animals, in the same way as the purebred animals, i. e, average live weights at different stages of growth, average weight gains per day, feed situation and type of animal management, was done in joint collaboration with the breeders Associations and the experts on Animal Production and Animal Genetic Improvement;
- Representative diets compositions, such as the type and proportion of food ingested (milk, grass pasture, forage supplement and compound feed) were established based on the collected information from the specific surveys responded by the breeder Associations and the experts collaborations of INIAV and UEvora on Nutrition and Animal Production;
- Digestible energy (DE%) of the representative diets were estimated by the expert of INIAV on Chemical and Nutritive evaluation of Animal Feed, considering the proportion and the data of the different feed constituents of each diet.

With the updated information the calculations of the non-dairy cattle, emission factors from enteric fermentation were reviewed.

¹² General Directorate for Food and Veterinary.

¹³ Indigenous breeds: Alentejana, Arouquesa Barrosã, Marinhova, Maronesa, Mertolenga, Minhota, Mirandesa, Preta; Exotic breeds: Charolesa, Limousine

¹⁴ Eng^o Nuno Carolino – Animal Production and Conservation and Animal Genetic Improvement, 2018; Eng^a Teresa Dentinho – Chemical and Nutritive evaluation of animal feed, 2018.

¹⁵ Prof. Manuel Cancela d'Abreu - Nutrition, Animal Feed and Animal Production

¹⁶ Documento nº 2/2019/ GT SNIERPA Agricultura of 8.04.2019.

¹⁷ First year where the detailed information needed became available

¹⁸ Indigenous breeds: Alentejana, Arouquesa Barrosã, Brava de lide, Cachena, Maronesa, Mertolenga, Minhota, Mirandesa e Preta; Exotic breeds: Abardeen-Angus, Charolesa e Limousine



The calculation was made individually for each subcategory, determined from the available statistical information as presented in Table 5-6.

Table 5-6: Livestock population by age – Non-dairy cattle

<1 yr	Beef Calves
	Calves, Males for Replacements
	Calves, Females for Replacements
1-2 yr	Males
	Beef Females
	Females for Replacement
>2 yr	Steers
	Heifers for Beef
	Heifers for Replacements
	Non-dairy cows

Gross Energy estimates for each cattle subcategory were determined using the energy model of the IPCC 2006¹⁹. First, Net Energies required for maintenance, animal activity, lactation, pregnancy, growth and work (NE_m , NE_a , NE_l , NE_p , NE_g , NE_{work}) were calculated using equations 10.3, 10.4, 10.8, 10.13, 10.6 and 10.11, respectively.

The ratios of the net energy available for maintenance and for growth in a diet to digestible energy consumed, REM and REG, were calculated using equations 10.14 and 10.15 (IPCC 2006).

Finally Gross Energy intake (GE), expressed in energy, was calculated using equation 10.16 (IPCC 2006).

For each cattle breed, purebred or crossbreed, the values used for parameters, such as weight, weight gain, feeding situation, diets and digestible energy, were those resulting from the updating data work, as explained above. Considering the average characteristics of the different breeds, the management systems and their territorial distribution, four non-dairy cattle groups were constituted: (1) Exotic breeds²⁰; (2) Traditional indigenous breeds on pasture²¹; (3) Traditional indigenous breeds on range²² (4) Crossbreed cattle. The difference between traditional animals “on pasture” and “on range” depends on the topography conditions, being assumed: the range situation is applied to breeds mostly existing in the south plains (“Montados”); the pasture situation occurs when in small grazing plots (“Prados” and “Lameiros”), as the existing in the north and centre regions. The majority of Crossbreed cattle, over 70 %, are mostly on the south plains.

For each cattle group were established the representative diets composition, type and proportion of food ingested (milk, pasture, forage and compound feed), considering three animal subcategories: less than 1 year, between 1 and 2 years and more than 2 years.

Depending on the cattle group and the subcategory the proportion of pasture on diet have a variation of 20% to 80%, forage supplemental a variation of 10% to 20% and compound feed a variation from 10% to 70%. Milk is only relevant for subcategory less than 1 year and the portion variation between cattle groups goes from 20% to 60%.

Digestible energy (DE %) of the different representative diets were calculated considering the proportion and the data of the different feed constituents of each diet. For the northern grass pasture, the calculated DE value is 55.4% while for the grass pasture in the south the calculated DE value is 65.2%. For both type of pasture, the respective DE values are an average of estimated seasonal DE values.

¹⁹ Volume 4, Chapter 10, pages 10.15 to 10.21

²⁰ Aberdeen-Angus, Charolesa and Limousine

²¹ Arouquesa, Barrosã, Cachena, Maronesa, Mertolenga, Minhota and Mirandesa

²² Alentejana, Brava de Lide, Mertolenga and Preta.



Also, supplemental forage components to north and south part are different and therefore the calculated DE values are 51.0% and 46.4% respectively. For compound feed it is considered a DE value of 82%. Considering the DE value of each food component and its proportion in the respective diet, the DE value of the total diet is obtained by weighting.

The calculations for each Cattle group and subcategories were done separately. The country weighted average values of the parameters and of the weighted average values of the calculated Net Energies, Gross Energy and Emission Factors are presented in Table 5-7 through Table 5-9.

Table 5-7: Parameters used in the determination of Net Energies for non-dairy cattle

Sub - categories	W (kg)	WG (kg.d ⁻¹)	Cfi	NEm (Mj.d ⁻¹)	Ca	NEa (Mj.d ⁻¹)	C	NEg (Mj.d ⁻¹)
Beef Calves (<1 yr)	244	0.905	0.322	19.873	0.171	3.413	0.9	9.451
Calves, Males Rep.(<1yr)	261	0.973	0.322	20.865	0.176	3.679	1.0	8.652
Calves, Fem.Rep.<1yr)	228	0.837	0.322	18.863	0.176	3.326	0.8	10.646
Males (1-2 yrs)	536	0.733	0.322	35.831	0.140	4.957	1.0	10.876
Beef Females(1-2 yrs)	428	0.479	0.322	30.263	0.140	4.174	0.8	9.306
Females Rep. (1-2yrs)	428	0.479	0.322	30.263	0.176	5.336	0.8	9.306
Steers (>2yrs)	772	0.188	0.370	54.116	0.265	14.341	1.2	2.802
Heifers for Beef (>2yrs)	548	0.062	0.322	36.435	0.265	9.655	0.8	1.177
Heifers Rep. (>2yrs)	548	0.062	0.322	36.435	0.265	9.655	0.8	1.177
Non-dairy cows	581	0.000	0.346	40.848	0.265	10.825	0.8	0.000

Table 5-8: Parameters used in the determination of Net Energies (non – dairy mother cows)

Parameter	Value
Percent pregnant	0.67
Milking period (days. yr ⁻¹)	201
Milk yield during milking period (kg. d ⁻¹)	6.49
Fat content of milk (%)	4.00
NE _i (Mj.d ⁻¹)	10.98
C _{pregnancy}	0.10
NE _p (Mj.d ⁻¹)	2.74

Table 5-9: Non-dairy cattle estimated Gross Energy (GE) and CH₄ Emission Factor (EF) from enteric fermentation

Sub - categories	∑ NE (Mj.d ⁻¹)	REM (ratio)	REG (ratio)	DE (%)	GE (Mj.d ⁻¹)	Ym (%)	EF (kg CH ₄ .hd ⁻¹ .yr ⁻¹)
Beef Calves (<1 yr)	32.74	0.55	0.37	81.77	82.49	0.055	16.47
Calves, Males Rep.(<1yr)	33.20	0.55	0.37	81.77	82.65	0.055	29.81
Calves, Fem.Rep.<1yr)	32.83	0.55	0.37	81.77	83.99	0.055	30.30
Males (1-2 yrs)	51.66	0.53	0.34	71.95	150.80	0.042	41.85
Beef Females(1-2 yrs)	43.74	0.53	0.34	71.95	127.52	0.042	35.21
Females Rep. (1-2yrs)	44.91	0.53	0.34	71.95	130.47	0.065	55.62
Steers (>2yrs)	71.30	0.51	0.30	62.73	230.96	0.065	98.46
Heifers for Beef (>2yrs)	47.27	0.51	0.30	62.73	151.53	0.065	64.60
Heifers Rep. (>2yrs)	47.27	0.51	0.30	62.73	151.53	0.065	64.60
Non-dairy cows	65.39	0.51	0.30	62.73	206.04	0.065	87.84

The updated emission factors presented in Table 5-9 are applicable from 2013 onwards. For the period 1990 to 1998 the previous emission factors, calculated with the information of 1998 database, were kept. Emission factors for the intermediate period, 1999 to 2012, were estimated by linear interpolation of 1998 and 2013 values.

Methane implied emission factors for non-dairy cattle category in the time series are presented in Table 5-10.

**Table 5-10: Methane implied emission factor (IEF) for non-dairy cattle category in the time series**

Year	IEF (kg CH ₄ .hd ⁻¹ .yr ⁻¹)
1990	61.52
1995	62.45
2000	62.80
2005	60.27
2010	59.75
2015	57.74
2019	58.14
2020	58.22
2021	58.18

In 2021, the non-dairy cattle implied emission factor (IEF) was 58.18 kg CH₄ hd⁻¹ yr⁻¹, which is slightly above the default IPCC 2006 values of 57/58 kg CH₄hd⁻¹ yr⁻¹.

5.2.3.3 Sheep and Goats

The same 1998 database from MA that was referenced previously for non-dairy cattle includes also information for the twelve indigenous breeds of sheep²³ and the five indigenous breeds of goats²⁴. Three exotic breeds of sheep²⁵ are also referenced, but no characterization data was available for them. The database includes information such as the number of registered animals, the number of producers, the main productive functions (milk, meat or wool), the dominant reproductive period, the weaning age and slaughtering, the weights (at birth, at 90 days and at adult age, for males and females separately), the milk and wool productions and the territorial distribution.

In 2019, the work of updating the 1998 database information was started, following the same methodology used on the non-dairy cattle update information, i.e. with the involvement of the Breeders Associations of the current most representative sheep and goats breeds used in Portugal and the experts on Nutrition and Animal Production and on Chemical and Nutritive Evaluation of Animal Feed, from the National Institute for Agriculture and Veterinary Research (INIAV)²⁶ and from the University of Évora (UEvora)²⁷. The work was finished in the middle of 2021²⁸, and we highlighted the following updates and sources:

- Through the system for the identification and registration of ovine and caprine animals²⁹ database it was possible to obtain the latest information about the composition of the sheep and goats populations from 2013³⁰ to 2018, i.e: the most representative sheep and goats breeds (7 indigenous and 2 exotics for sheep³¹ and 5 indigenous and 2 exotics for goats³²) and also the proportion and the territorial distribution of purebred and of crossbred animals;

²³ Campaniça, Churra Algarvia, Churra Badana, Churra da Terra Quente, Churra Galega Bragançana, Churra Galega Mirandesa, Merina Branca, Merina Preta, Merina da Beira Baixa, Mondegueira, Saloia and Serra da Estrela.

²⁴ Algarvia, Bravia, Charnequeira, Serpentina and Serrana.

²⁵ Assaf, Ile de France and Merino Precoce.

²⁶ Eng^o Nuno Carolino – Animal Production and Conservation and Animal Genetic Improvement; Eng^a Teresa Dentinho – Chemical and Nutritive evaluation of animal feed.

²⁷ Prof. Manuel Cancela d'Abreu - Nutrition, Animal Feed and Animal Production

²⁸ Documento nº 3/2021/ GT SNIERPA Agricultura,6.07.2021

²⁹Council Regulation (EU) 2016/429 of 9 March 2016 ([consolidated version](#)), Decreto-Lei nº 142/2006 de 27 de julho ([consolidated version](#))

³⁰ First year where the detailed information needed became available

³¹ Indigenous breeds: Campaniça, Bordaleira de Entre Douro e Minho, Churra Galega Bragançana, Churra da Terra Quente, Churra Galega Mirandesa, Merino and Serra da Estrela; Exotic breeds: Assaf e Lacaune

³² Indigenous breeds: Algarvia, Bravia, Charnequeira, Serpentina and Serrana; Exotic breeds: Murciano-Granadino and Saanen



- For each purebred, an update of animal characteristics was collected from the breeders Associations through a specific survey, providing relevant information, such as: live-weights of males and females at different stages of growth (from birth to adult age, including weights at weaning and at slaughtering age of lambs and kids), average weight their gains per day, wool production per year, feeding practises and type of animal management. For ewes and does it was also collected information about average milk production per year and the number of lambs/kids per birth (single, double or triple births);
- The characterization of crossbred animals, in the same way as the purebred animals, i. e, average live weights at different stages of growth, average weight gains per day, wool production per year, feed situation and type of animal management and the specific female characteristics milk production and lambs/kids per birth, was done in joint collaboration with the breeders Associations and the experts on Animal Production and Animal Genetic Improvement;
- Representative diets compositions, such as the type and proportion of food ingested (milk, grass pasture, forage supplement, compound feed and also tree and shrub vegetation in the case of the goats), were established based on the collected information from the specific surveys responded by the Breeders Associations and the experts collaborations of INIAV and UEvora on Nutrition and Animal Production;
- Digestible energy (DE%) of the representative diets were estimated by the expert of INIAV on Chemical and Nutritive evaluation of Animal Feed, considering the proportion and the data of the different feed constituents of each diet.

With the updated information the calculations of the sheep and goats emission factors from enteric fermentation were reviewed and are presented in this year submission.

In a similar mode to that used for cattle, the energy model proposed in the IPCC 2006³³ for sheep and in the IPCC Refinement 2019³⁴ for goats, was used.

Net Energies required for maintenance, animal activity, lactation, pregnancy and wool production (NE_m , NE_a , NE_l , NE_p , NE_g , NE_{wool}) were calculated using equations 10.3, 10.5, 10.9, 10.13, 10.7 and 10.12 (IPCC 2006 and Refinement 2019³⁵).

The ratios of the net energy available for maintenance and for growth in a diet to digestible energy consumed, REM and REG, were calculated using equations 10.14 and 10.15 (IPCC 2006).

Finally Gross Energy Intake (GE), expressed in energy, was calculated using equation 10.16 (IPCC 2006 and Refinement 2019).

Estimates was done individually for each breed, purebred or crossbred, and distinctly for females (ewes and does), males (rams and bucks) and lambs and kids (for slaughtering). Parameters and final energy values were averaged using the number of registered animals as weighting factor and are presented in the next set of Tables.

³³ Volume 4, Chapter 10, pages 10.15 to 10.21

³⁴ Volume 4, Chapter 10, pages 10.22 to 10.29

³⁵ In the Refinement 2019 to IPCC Guidelines the same equations are updated to be used also for goats.



Table 5-11: Parameters used in determination of Net Energies for sheep and goats from 1990 to 1998

Parameters	Sheep			Goats		
	Ram	Ewe	Lambs	Buck	Doe	Kids
Lifetime (days.yr ⁻¹)	365	365	80	365	365	53
W (kg)	79.9	53.8	19.1	37.5	28.5	10.0
Cfi ¹	0.250	0.217	0.254	0.250	0.217	0.254
NEm (Mj.day ⁻¹)	6.58	4.30	2.28	3.79	2.68	1.43
Ca ²	0.017	0.017	0.017	0.024	0.024	0.024
NEa (Mj.day ⁻¹)	1.39	0.93	0.33	0.90	0.68	0.24
WG (kg.day ⁻¹)	-	-	0.064	-	-	0.160
NEg (Mj.day ⁻¹)	-	-	0.90	-	-	1.08
Wool (kg.yr ⁻¹)	6.5	3.6	-	-	-	-
NEwool (Mj.day ⁻¹)	0.43	0.23	-	-	-	-
Milk production (kg.day ⁻¹)	-	0.183	-	-	1.238	-
Energy value milk (Mj.kg ⁻¹)	-	4.60	-	-	2.80	-
NEi (Mj.day ⁻¹)	-	0.84	-	-	3.47	-
Cpregnancy ³	-	0.08	-	-	0.08	-
NEp (Mj.day ⁻¹)	-	0.33	-	-	0.21	-

¹Ram and Bucks Cfi value was increased 15% for intact males
² Sheep – average for different feed situations: grazing flat and hilly pasture rams, grazing flat and housed ewes, grazing flat and housed fattening lambs; Goats – lowland and grazing hilly pasture
³ Sheep – average single and double births; Goats – single, double and triple births

Table 5-12: Parameters used in determination of Net Energies for sheep and goats from 2013 onwards

Parameters	Sheep			Goats		
	Ram	Ewe	Lambs	Buck	Doe	Kids
Lifetime (days.yr ⁻¹)	365	365	80	365	365	53
W (kg)	79.9	53.8	19.1	49.0	65.0	11.4
Cfi ¹	0.250	0.217	0.236	0.315	0.315	0.315
NEm (Mj.day ⁻¹)	5.00	5.29	2.90	7.18	5.81	1.95
Ca ²	0.017	0.010	0.009	0.017	0.010	0.009
NEa (Mj.day ⁻¹)	1.53	0.72	0.25	1.13	0.50	0.10
WG (kg.day ⁻¹)	-	-	0.184	-	-	0.126
NEg (Mj.day ⁻¹)	-	-	2.35	-	-	1.12
Wool (kg.yr ⁻¹)	2.5	1.8	-	-	-	-
NEwool (Mj.day ⁻¹)	0.16	0.12	-	-	-	-
Milk production (kg.day ⁻¹)	-	0.334	-	-	0.539	-
Energy value milk (Mj.kg ⁻¹)	-	4.60	-	-	3.00	-
NEi (Mj.day ⁻¹)	-	1.54	-	-	1.62	-
Cpregnancy ³	-	0.10	-	-	0.13	-
NEp (Mj.day ⁻¹)	-	0.45	-	-	0.69	-

¹Ram and Bucks Cfi value was increased 15% for intact males
² Sheep – average for different feed situations: grazing flat and hilly pasture rams, grazing flat and housed ewes, grazing flat and housed fattening lambs; Goats – lowland and grazing hilly pasture
³ Sheep – average single and double births; Goats – single, double and triple births

**Table 5-13: Sheep and goats estimated Gross Energy (GE) and CH₄ Emission Factor (EF) from enteric fermentation – from 1990 to 1998**

Parameters	Sheep			Goats		
	Ram	Ewe	Lambs	Buck	Doe	Kids
REM	0.495	0.495	0.529	0.495	0.495	0.529
REG	0.278	0.278	0.333	0.278	0.278	0.333
DE (%)	60	60	70	60	60	70
GE (Mj.day ⁻¹)	29.38	22.98	10.94	15.80	23.71	9.14
Ym (%)	6.5	6.5	4.5	5.0	5.0	5.0
EF(kg CH ₄ .hd ⁻¹ .yr ⁻¹)	12.53	9.80	3.23	5.18	7.78	3.00

Table 5-14: Sheep and goats estimated Gross Energy (GE) and CH₄ Emission Factor (EF) from enteric fermentation – from 2013 onwards

Parameters	Sheep			Goats		
	Ram	Ewe	Lambs	Buck	Doe	Kids
REM	0.505	0.509	0.562	0.490	0.496	0.568
REG	0.295	0.300	0.388	0.270	0.280	0.397
DE (%)	62.89	63.65	88.96	59.46	61.00	94.32
GE (Mj.day ⁻¹)	21.46	25.31	13.25	28.98	28.45	6.83
Ym (%)	6.50	6.50	4.50	5.00	5.00	4.00
EF(kg CH ₄ .hd ⁻¹ .yr ⁻¹)	9.15	10.79	3.91	9.50	9.33	1.79

The updated emission factors presented in Table 5-14 are applicable from 2013 onwards. For the period 1990 to 1998 the previous emission factors, calculated with the information of 1998 database, were kept. Emission factors for the intermediate period, 1999 to 2012, were estimated by linear interpolation of 1998 and 2013 values.

Methane implied emission factors for sheep and goats categories in the complete time series are presented in the next two Tables.

Table 5-15: Methane implied emission factor (IEF) for sheep category in the time series

Year	IEF (kg CH ₄ .hd ⁻¹ .yr ⁻¹)
1990	9.74
1995	9.92
2000	9.77
2005	9.28
2010	9.25
2015	9.49
2019	9.70
2020	9.75
2021	9.78

Table 5-16: Methane implied emission factor (IEF) for goat category in the time series

Year	IEF (kg CH ₄ .hd ⁻¹ .yr ⁻¹)
1990	7.02
1995	6.94
2000	6.98
2005	7.19
2010	7.20
2015	7.26
2019	7.30
2020	7.29
2021	7.28



In 2021, the implied emission factors (IEF) for sheep enteric fermentation was 9.78 (kg CH₄.hd⁻¹.yr⁻¹) and the IEF for goats enteric fermentation was 7.28 (kg CH₄.hd⁻¹.yr⁻¹). Both IEFs are higher than the respective default values IPCC 2006, but similar with the values of other countries that used a Tier 2 approach to estimate emission factors from enteric fermentation of sheep and goats.

5.2.3.4 Swines and Rabbits

The methodology used by the French I.N.R.A. (INRA, 1984) was used to estimate feed intake for each swine sub-class, according to the following equation:

Equation 5-3: Swines estimated Gross Energy (GE)

$$GE = \text{Feed}_{ED} / (DE / 100)$$

Where:

GE – gross energy intake, Mj . hd⁻¹. day⁻¹

Feed_{ED} – recommended feed ingestion, expressed in digestible energy, MJ_{ED}.day⁻¹

DE – digestible energy, expressed as a percentage of gross energy, %

The characteristics of each animal class as they were used to derive final emission factors for CH₄ emissions from enteric fermentation were obtained from INRA (1984) for each animal sub-class and are presented in Table 5-17.

Table 5-17: Parameters used in determination of Gross Energy (GE) and enteric fermentation methane emission factor for swine and rabbits

	W (kg)	ED (Mj.d ⁻¹)	DE (%)	EF (kg CH ₄ .hd ⁻¹ .yr)	Ym (%)	Notes
Swine						
Piglets (<20 kg)	10.0	6.2	88.2	0.28	0.6	Avg. 22 to 42 d.
Fattening Swines (20-50 kg)	35.0	23.4	83.4	1.11		Regression
Fattening Swines (50-80 kg)	65.0	34.5	83.4	1.63		ED = 17.93*Ln(W)-40.13
Fattening Swines (80-110 kg)	95.0	41.3	83.4	1.95		
Fattening Swines (> 110 kg)	120.0	45.5	83.4	2.15		
Boars (>50 kg)	250.0	32.4	78.2	1.63		
Sows, pregnant	170.0	31.4	78.2	1.58		Sow in gestation
Sows, non-pregnant	195.00	64.9	78.2	3.26		Sow in lactation
Rabbits						
Reproductive Female	-	4.0	59.0	0.27	0.6 ¹	Per female cage

¹From Italian NIR

In 2021, the IEF from enteric fermentation by swines was 1.15 (kg CH₄.hd⁻¹.yr⁻¹) which is lower than the default IPCC 2006 but not so different.



5.2.3.5 Poultry³⁶

The methodology that was used to derive Gross Energy ingestion is similar to that used for swines and rabbits, albeit Metabolic Energy (ME) is used as indicator of feed ingestion, and digestibility is replaced by Metabolisability (McDonald et al, 2002; INRA, 1985):

Equation 5-4: Poultry estimated Gross Energy (GE)

$$GE = \text{Feed}_{ME} / [(EM/GE) / 100]$$

Where:

GE – gross energy, Mj.hd⁻¹.day⁻¹

Feed_{ED} – recommended metabolic energy, MJ.day⁻¹

EM/GE – Metabolisability, metabolic energy expressed as a percentage of gross energy, %

Table 5-18: Parameters used in determination of Gross Energy (GE) – Poultry

	Energy intake (Mj.d ⁻¹)	Metabolizability (Mj.d ⁻¹)	GE (Mj.d ⁻¹)	Ym (%)
Broiler	1.06	68.3	1.56	NA
Laying hens (eggs)	1.39	63.5	2.20	NA
Laying hens (reproduction)	1.36	63.5	2.15	NA
Turkeys	3.23	68.0	4.75	NA
Ducks¹	1.46	65.8	2.22	NA

¹used as reference for other poultry

It is important to point out that for poultry there is no methane conversion rate and thus no enteric fermentation emissions. The choice to include the GE methodology for poultry in this chapter was made to maintain coherence between animal types.

5.2.4 Activity Data

General census on agriculture³⁷ and animal husbandry activities are made every 10 years by the National Statistical Institute (INE) in accordance with UE requirements. The first census was made in 1952/54, followed by exercises in 1968, 1979, 1989, 1999, 2009 and 2019. Last census (RA, 2019), considered the survey of all national territory at the same time. Inquiries were done at each individual production unit by direct interview.

The general agriculture census is subjected to several Quality Control measures by INE. The complete National Methodological Report is available at Eurostat website³⁸.

Also, through Farm Structure Survey (FSS) about 40 000 farms (production units) were surveyed, every two years. From 2010 the interval between surveys has been extended³⁹ to 3 years. The complete National Methodological Report of 2013 and 2016 FSS is also available at Eurostat website⁴⁰.

Annually livestock numbers⁴¹ for cattle, swine, sheep and goats are estimated through the National Animal Registration database (SNIRA).

³⁶ CH₄ emissions from Enteric Fermentation are not estimated for Poultry. Nevertheless GE is estimated for these animal types for the estimate of CH₄ emissions from Manure Management. GE is reported here for better comparison to the GE values for other animal types

³⁷ In portuguese Recenseamento Geral Agrícola (RGA 1989 and RGA 1999), Recenseamento Agrícola (RA 2009, RA 2019)

³⁸ [Methodology - Agriculture - Eurostat \(europa.eu\)](https://ec.europa.eu/eurostat/tgm/table.do?tab=table&init=1&language=en&plugin=1) > Structure of agricultural holdings - metadata > National metadata > Portugal

³⁹ Regulation (EU) n° 2018/1091, on integrated farm statistics and repealing Regulations (EC) n° 1166/2008 and (EU) n° 1337/2011 (See [consolidated version](#)).

⁴⁰ [Methodology - Agriculture - Eurostat \(europa.eu\)](https://ec.europa.eu/eurostat/tgm/table.do?tab=table&init=1&language=en&plugin=1) Structure of agricultural holdings - metadata > National quality reports>Portugal.

⁴¹ Regulation (EC) n° 1165/2008, concerning livestock and meat statistics and repealing Council Directives 93/23/EEC, 93/24/EEC and 93/25/EEC (See [consolidated version](#))



Using these data sources, INE built consistent time series of annual livestock numbers from 1987 to 2021 for cattle, swine, sheep and goats, disaggregated per region⁴², age and sex.

All original figures in statistical database represent the annual average population.

Statistical data from the INE for the sheep and the goats does not distinguish the category "lambs" or "kids". The annual sheep and goat population is disaggregated between two broad categories: "ewes" and "other ovine", for sheep, and "does" and "other caprine", for goats. Thus, the annual number of lambs and kids was set from the number of registered slaughtered animals, as published by the National Statistics Institute (INE). The number of lambs and kids reported as activity data represents the equivalent annual average of animals, i.e.:

$$\text{Lambs/Kids (hd)} = \text{Annual Slaughter (hd/yr)} * \text{Age_Slaughter (days)} / 365$$

The age at which slaughter occurs (Age_Slaughter) was determined from the inverse function of the growth models⁴³ for both species, Figure 5-8, using the weight at slaughter as published by INE, which values are presented in Figure 5-9. Resultant average ages vary from 107 to 134 days for lambs and 69 to 104 days for kids.

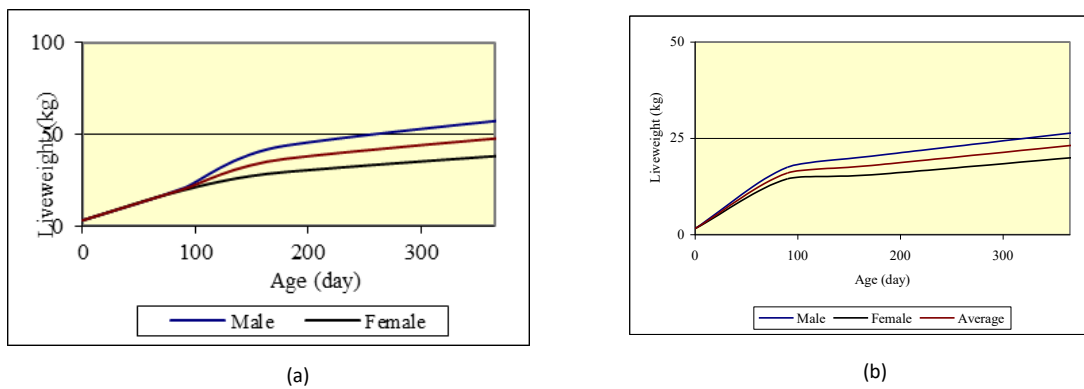

Figure 5-8: Evolution pattern growth for sheep (a) and goats (b)

⁴² A total of 7 regions were available: the 5 regions in mainland Portugal (NUT II level), Norte, Centro, Lisboa e Vale do Tejo, Alentejo and Algarve and the two Autonomous regions of Azores and Madeira.

⁴³ Set up from the information on existing breeds in Portugal, complemented by information of Jarrige (1988) related with growth patterns.

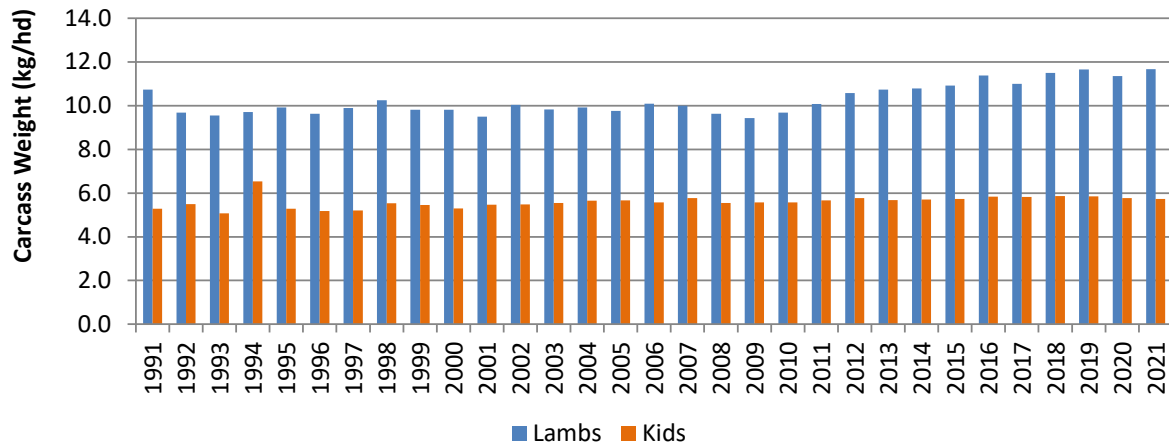

Figure 5-9: Lambs and Kids: average carcass weight at slaughtering

The number of animals remaining from the total Sheep and Goats populations after subtraction of number of females (ewes and does) and the number of youngsters (lambs and kids) is reported as “Other Ovine” and “Other Caprine”. These animals are mostly adult males, but also young animals that are kept to reproductive functions and are not slaughtered.

The population of horses, mules and asses, poultry and rabbits (reproductive females) is established from the results of the Agricultural Census and the Farm Structure Survey. The disaggregation of hens for industrial egg production and hens for production of chicks was obtained from the Annual Survey of eggs production and the Annual Survey of Industrial Poultry, published by INE.

Gaps in the livestock time series were corrected with linear interpolation.

For all animal types the value that was considered as activity data is the average of the last three years, i.e., the activity data reported for year n (1990 given as example) is the average of livestock numbers for n-2, n-1 and n (1988, 1989 and 1990).

In Table 5-19 is presented the annual livestock numbers (1990, 1995, 2000, 2005, 2010, 2015 and the three last years) that are activity data for CH₄ emission estimates from enteric fermentation (CRF 3A). In a consistent way same activity data are used to estimate CH₄ emissions and N₂O emissions from manure management systems (CRF 3B) and N₂O emissions from animal manure applied to soil and from urine and dung deposited by grazing animals (CRF 3D). The complete time series data is included in the ANNEX C: Agriculture.



Table 5-19: Livestock population (thousands)

Animal class	Sub-class	1990	1995	2000	2005	2010	2015	2019	2020	2021
Dairy cattle	Dairy cows	394	383	353	290	255	235	235	233	232
Non-dairy cattle	Beef calves (<1 yr)	46	60	67	104	114	112	109	107	103
	Calves M.Rep. (<1 yr)	186	162	144	136	123	152	172	175	182
	Calves F Rep. (<1 yr)	177	158	174	183	171	209	232	236	244
	Males 1-2 yrs	112	103	82	81	66	58	70	70	65
	Beef Fem. 1-2 yrs	18	22	17	17	20	15	15	16	16
	Females rep. 1-2 yrs	111	109	127	135	137	148	158	157	155
	Steers (>2 yrs)	38	33	26	25	38	37	60	62	60
	Heifers Beef (>2 yrs)	4	10	6	9	12	15	14	12	11
	Heifers rep. (>2 yrs)	45	52	67	94	110	96	98	98	94
	Non-dairy cows	242	273	345	397	438	461	492	497	504
Swine	Piglets (<20 kg)	727	726	663	574	597	713	771	797	815
	Fatt. Swines (20-50 kg)	662	660	585	467	448	485	469	453	440
	Fatt. Swines (50-80 kg)	525	525	483	368	360	380	381	387	394
	Fatt. Swines (80-110 kg)	218	198	174	214	244	285	312	319	309
	Fatt. Swines (>110 kg)	44	44	38	41	36	30	34	45	51
	Boars (>50 kg)	26	26	20	12	7	6	5	5	5
	Sows, pregnant	210	211	195	191	179	162	163	163	160
	Sows, non-pregnant	124	132	124	68	66	71	73	72	72
Sheep	Ewes	2 292	2 339	2 410	2 293	1 915	1 620	1 664	1 668	1 678
	Other Ovine	663	817	734	234	192	237	378	406	426
	Lambs	307	278	319	322	277	194	191	186	185
Goats	Does	614	517	460	380	356	324	333	322	312
	Other Caprine	149	151	129	57	40	39	38	38	37
	kids	47	41	33	26	29	20	19	18	18
Equidae	Horses	33	48	58	60	92	78	82	85	87
	Asses & Mules	118	103	69	60	24	11	9	9	9
Poultry	Hens, reproductive	3 421	3 271	2 644	3 056	3 453	2 920	3 767	4 109	4 260
	Hens eggs	7 539	7 745	9 060	7 349	7 867	6 710	9 556	10 533	11 041
	Broilers	18 524	18 813	24 374	18 686	19 207	19 395	30 702	32 904	34 006
	Turkeys	1 149	945	1 208	798	1 445	785	1 505	1 735	1 849
	Other poultry	1 571	1 551	1 622	1 376	1 522	1 284	2 823	3 172	3 346
Other	Rabbits ¹	475	401	336	289	255	148	148	162	169

¹Female reproductive



5.2.5 Uncertainty Assessment

Uncertainties estimates of livestock numbers are based on the information provided by the National Statistical Institute (INE) and are presented in Table 5-20.

Table 5-20: Livestock population uncertainty assessment

Animal type	U (%)
Dairy Cattle	1.19
Non-dairy cattle	3.47
Sheep	0.59
Goats	6.0
Swines	7.5
Equidae	7.8
Poultry	15.0
Rabbits	20.0

The calculated uncertainty of diet digestibility estimates for dairy cows has a value of 6.5%. It was determined using the error propagation equation considering the standards deviations associated to the digestibility value of each food component included in dairy cows diets in use on the milk productions regions of Azores and Mainland.

The calculated uncertainty of diet digestibility estimates for non-dairy cattle has a value of 9.7%. In the same way of the dairy cows calculations, it was determined using the error propagation equation considering the standards deviations associated to the digestibility value each food component included in the diets of each non–dairy cattle group and subcategories.

Uncertainty calculation of DE% diets for dairy cattle and non-dairy cattle, was derived from the results of chemical and nutritional analysis of each food component of the diet, carried out by the experts on Chemical and Nutritive evaluation of animal feed of the National Institute for Agriculture and Veterinary Research (INIAV) and from the expert judgement on Nutrition and Animal Production of the experts from INIAV and University of Évora for the proportion of the food components on each diets, dairy and non-dairy cattle.

For the uncertainties calculations the error propagation equation of IPCC's Approach 1 analysis was used. Equation 3.1 and 3.2 were used to combine the uncertainties of food components and of its proportion in each diet. This procedure was repeated for each of the different diets established. In the case of dairy cows two diets were considered: one for the mainland region and another for the Azores region. The overall uncertainty of DE% at a national level was derived from the combination of the DE uncertainty calculated for each milk production region (Mainland and Azores) with the uncertainties of the number of dairy cows in each of those regions. The uncertainties of dairy cows per region are derived from the National Statistics Authority data.

In the case of non-dairy cattle, the same procedure was used considering the different diets established (food components and proportion on diet) for each cattle group and subcategories (Groups: exotics, traditional on pasture, traditional on range and crossbreed cattle; subcategories: less than 1 year, 1 to 2 years, more than two years)

The uncertainty of digestibility for all animals' categories other than cattle, where tier 2 was used, was assumed 20% in line with the IPCC 2006 (section 10.2.3, chapter 10, Volume 4).



The uncertainty of the emission factor was assumed to be 20% for all animals where tier 2 was used and 50% when tier 1 emission factors were used, in accordance with the IPCC 2006 (section 10.3.4, chapter 10, Volume 4).

5.2.6 Category specific QA/QC and verification

For this source category QA/QC procedures were focused in the livestock data obtained from INE. Two quality assessments of the livestock numbers were produced:

- Comparison between data from Agricultural General Census (every 10 year) and data from Farm Structure Survey (every two or three years) concerning horses, mules & asses, poultry and rabbits to check any outliers;
- Comparison between livestock data obtained from INE and FAO numbers for cattle, sheep, goats and swine population.

Livestock numbers used in the inventory, as collected from National Statistics, were compared to FAO livestock numbers for years 1990-2020 (2021 not available) and the results are presented in the Figure 5-10 for cattle, swine and sheep.

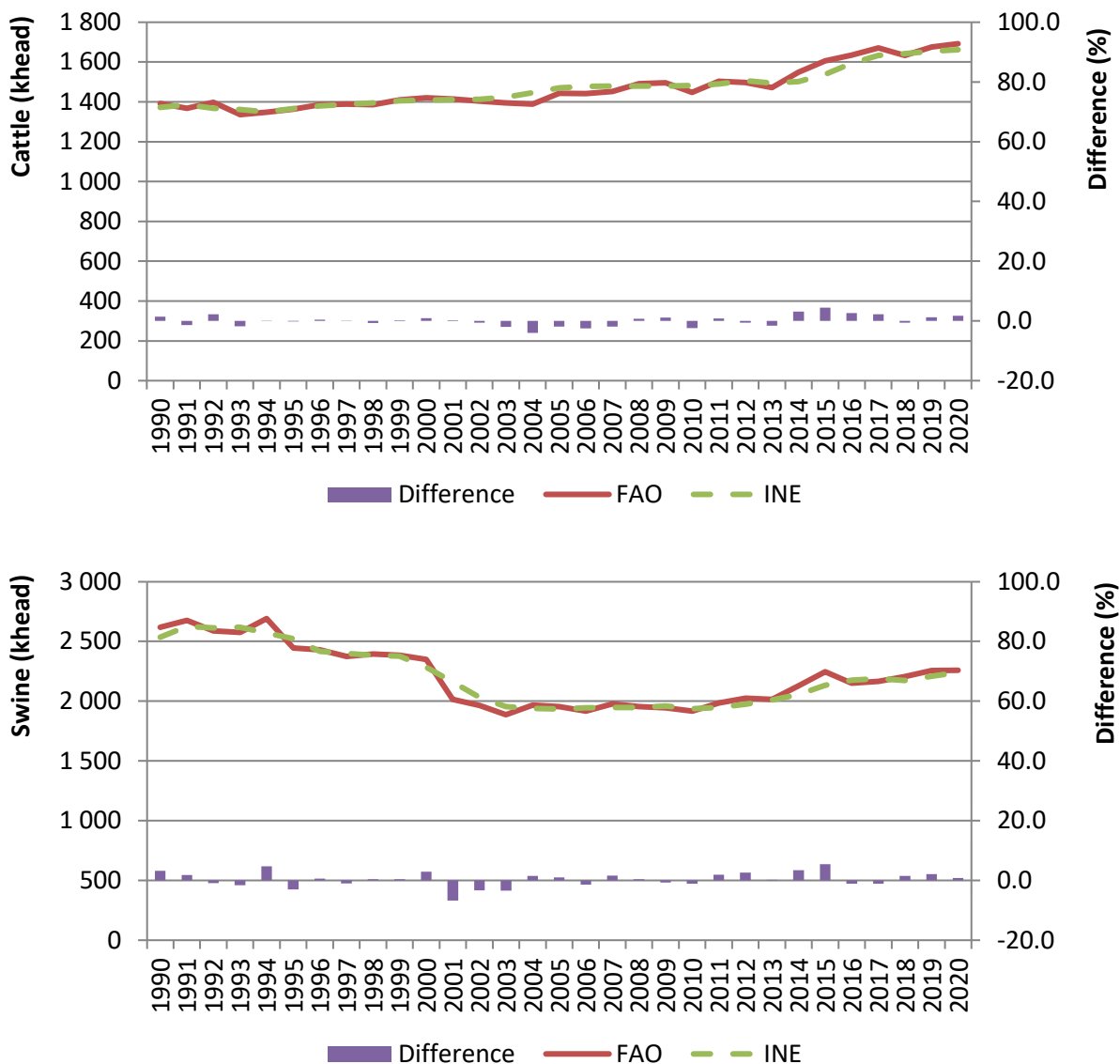

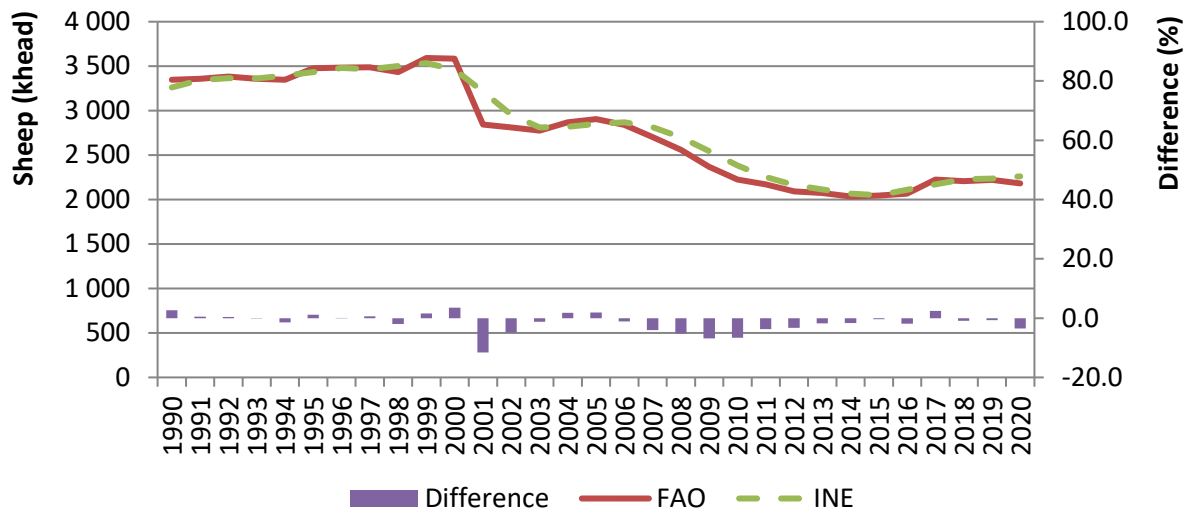

Figure 5-10: Livestock numbers: comparison between National Statistics and FAO database

FAO and INE livestock numbers have a good adhesion for all species.

QA/QC also included a series of checks: calculation formulas verification, data and parameters verification and the information provided in this report.

5.2.7 Category specific recalculations

The differences between submissions are graphically represented in the next figure.

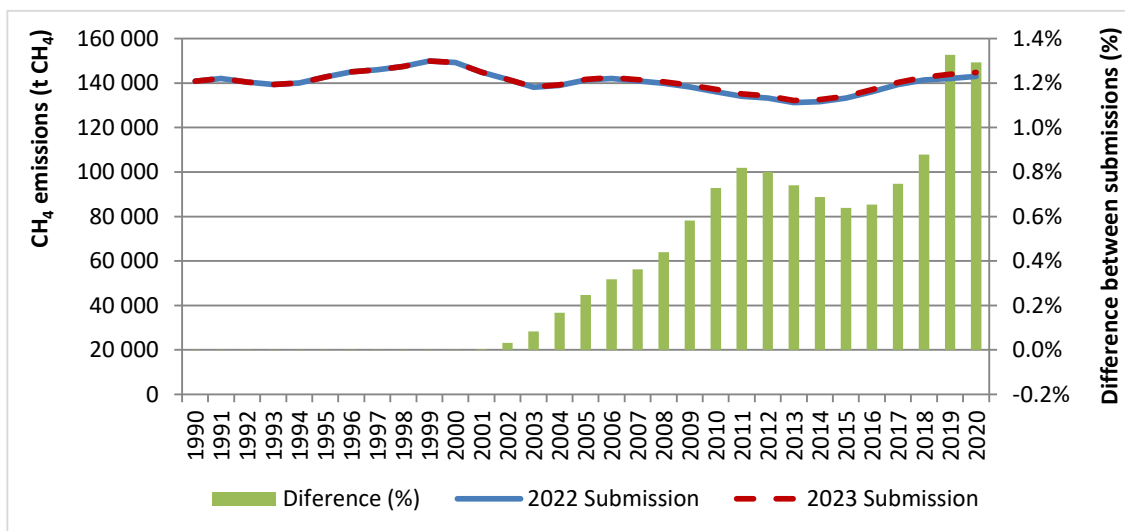

Figure 5-11: Total enteric fermentation emissions (t CH₄). Differences between 2022 and 2023 submissions



Differences in CH₄ emissions between 2022 and 2023 submissions are mainly due to:

- the revision of National Statistics on Mules and Asses livestock numbers from 2002 onwards;

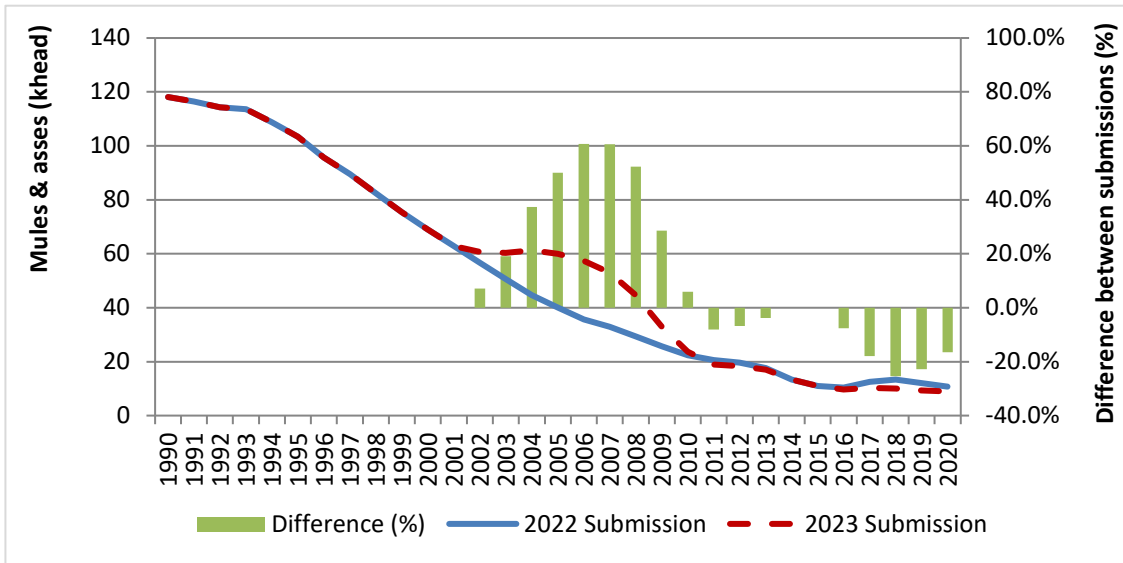

Figure 5-12: Differences in Mules & asses livestock numbers between submissions

- the revision of National Statistics on Horses livestock numbers from 2003 onwards;

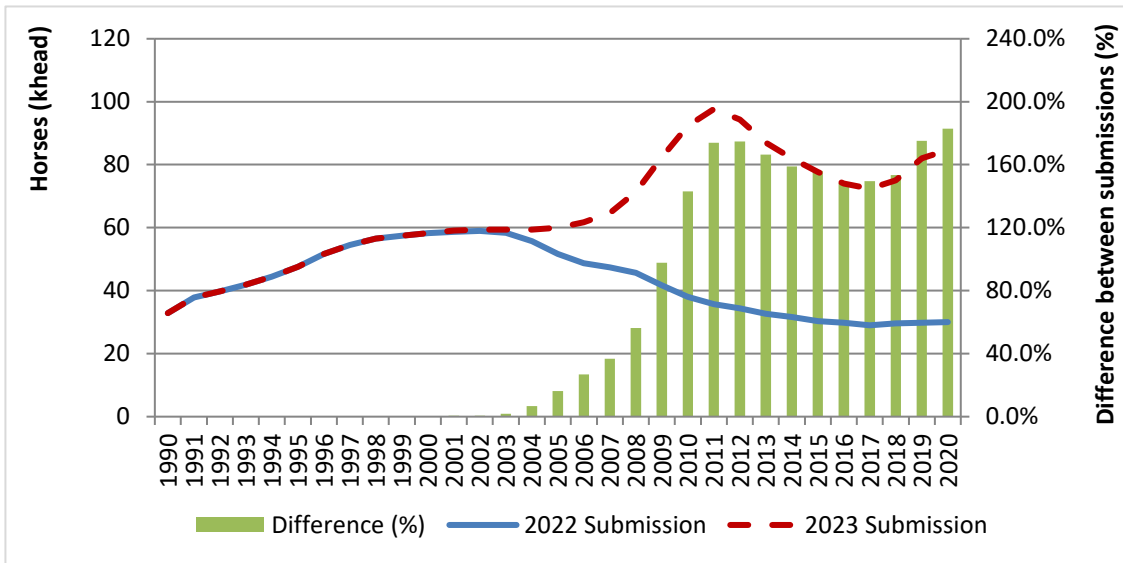

Figure 5-13: Differences in Horses livestock numbers between submissions



- the revision of National Statistics on Goats livestock numbers from 2016 onwards;

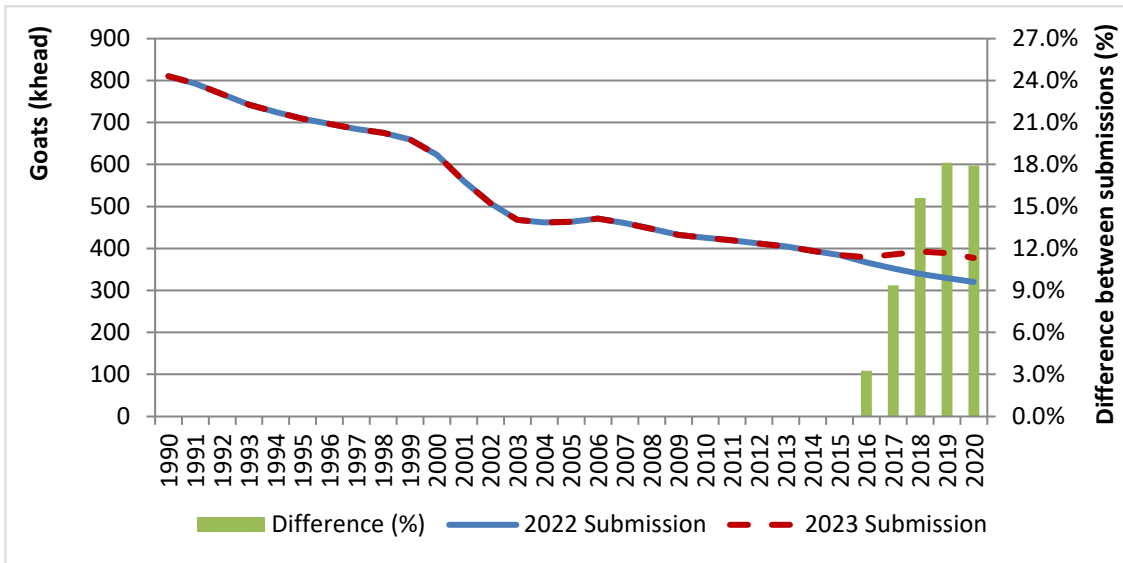

Figure 5-14: Differences in Goats livestock numbers between submissions

- the revision of National Statistics on Sheep livestock numbers from 2016 onwards;

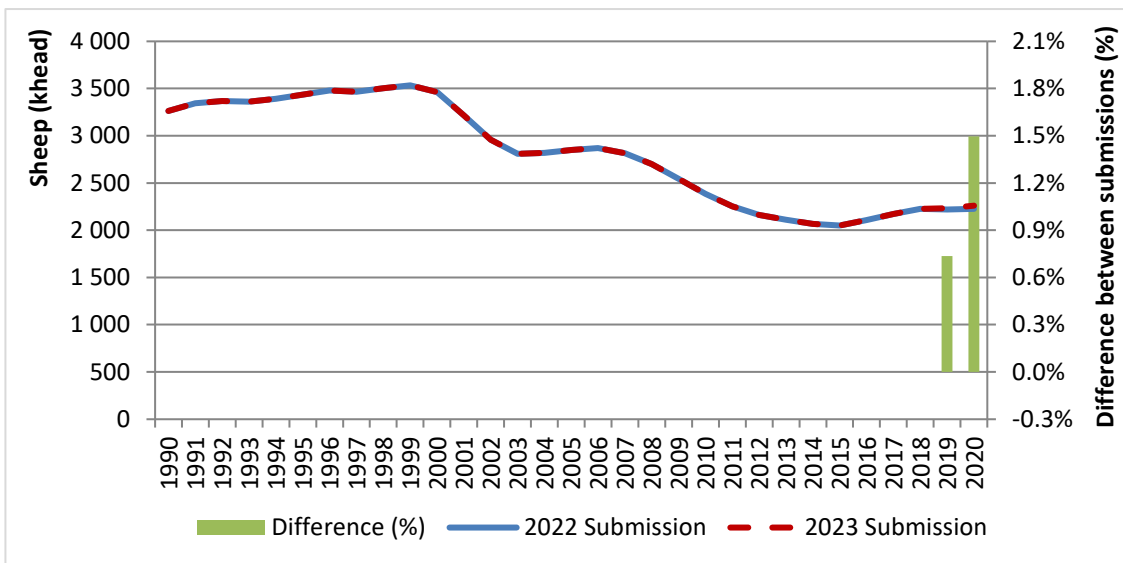

Figure 5-15: Differences in Sheep livestock numbers between submissions

5.2.8 Category specific planned improvements

No category specific further improvements planned.



5.3 CH₄ Emissions from Manure Management (CRF 3.B.a)

5.3.1 Category description

Methane emissions from manure occur when the organic material it contains, either solid or dung or liquid as urine, decomposes during storage or treatment, in anaerobic environments by the action of methanogenic bacteria. The quantity that is emitted depends mostly of the existence of anaerobic conditions during storage of manure that promotes the activity of methanogenic microorganisms. Methane emissions resulting from manure deposited directly in soil during grazing and pasture are also included in this source category⁴⁴.

In Table 5-21 are presented the estimates of CH₄ emission from manure management.

Table 5-21: CH₄ emissions from Manure Management (kt)

Livestock type	1990	1995	2000	2005	2010	2015	2019	2020	2021
Dairy cattle	5.76	5.91	6.77	6.45	6.29	6.03	6.16	6.16	6.14
Non- dairy cattle	2.17	2.25	2.38	2.50	2.48	2.45	2.72	2.75	2.75
Sheep	1.34	1.38	1.31	0.98	0.77	0.67	0.74	0.75	0.76
Goats	0.26	0.22	0.19	0.14	0.12	0.11	0.11	0.10	0.10
Horses	0.12	0.16	0.18	0.16	0.21	0.18	0.19	0.20	0.21
Mules and Asses	0.18	0.15	0.09	0.07	0.02	0.01	0.01	0.01	0.01
Swine	20.24	20.30	18.50	15.46	15.41	16.45	16.60	16.69	16.63
Poultry	2.20	2.20	2.56	2.08	2.34	1.99	2.95	3.19	3.30
Rabbits	0.13	0.11	0.09	0.07	0.06	0.04	0.04	0.04	0.04
Total	32.41	32.67	32.07	27.91	27.71	27.92	29.51	29.88	29.94

Note: Totals may not sum due to independent rounding

Methane emission from Manure Management in Portugal is a key source. According to origin of manure by specie, most emissions in 2021 result from swine manure, with 55.56%, and from cattle manure, with 29.70% (20.51% dairy and 9.19% non-dairy cattle), as may be seen in Figure 5-16.

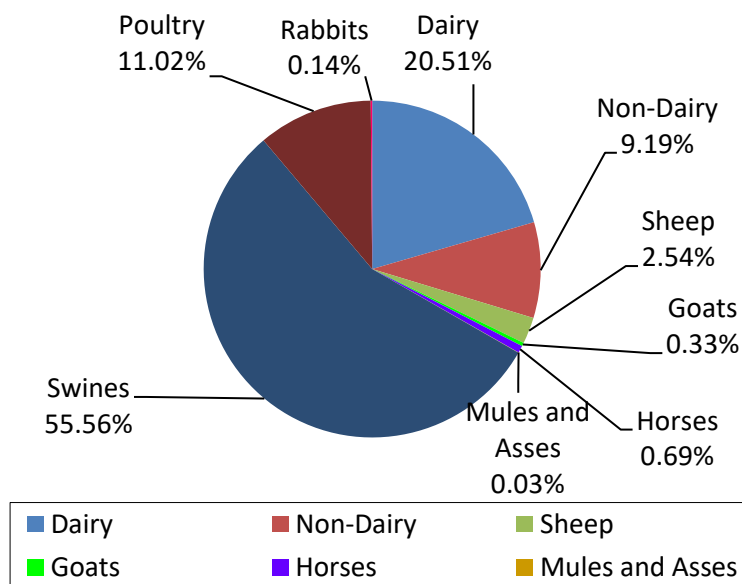

Figure 5-16: Relative importance of CH₄ emissions from Manure Management per each animal species in 2021

⁴⁴ Nitrous oxide emissions from manure deposited in soil during grazing and pasture are nevertheless included in source category N₂O from agricultural soil: Animal production, in accordance with UNFCCC reporting guidelines.



5.3.2 Methodological issues

Following the IPCC 2006, emission estimates are calculated based on the equation 10.22⁴⁵, applied for each animal type and considering emission factors dependent on animal type and climatic conditions. By this procedure both the quantity of manure produced per animal and the storage conditions are included in the determination of the emission factor, and will be discussed thereafter.

Equation 5-5: CH₄ emissions from Manure Management

$$Emi_{CH_4} = \sum_t \sum_c. [EF_{(i,k)} * N_{(i,k)}]$$

Where:

Emi_{CH₄}: methane emissions from manure management, for the animal type population, kg CH₄.yr⁻¹

EF_(i,k): emission factor for the animal type population i, living in climate region k, kg.head⁻¹.yr⁻¹

N_(i,k): total number of the animals of type i, living in climate region k, head

5.3.3 Emission Factors

Emissions Factors for each animal type were established according to the tier 2 methodology proposed in IPCC 2006 (equation 10.23), which considers the use of country specific information concerning the quantity of manure produce per animal and the share of each Manure Management System (MMS) that is used for each animal type. The equation used for the calculation of the EF for each animal species is therefore:

Equation 5-6: CH₄ emission factor from Manure Management

$$EF_{(i)} = (VS_{(i)} * 365) * [Bo_{(i)} * 0.67 * \sum_{jk} MCF_{(jk)}/100 * MMS_{(ijk)}]$$

Where:

EF_(i): annual emission factor for a defined animal species i, kg CH₄ hd⁻¹ yr⁻¹

VS_(i): daily volatile solids excreted for animal species i, living in climate region k, kg dm.day⁻¹

Bo_(i): maximum CH₄ production capacity from manure for animal species i, m³ CH₄.kg⁻¹ VS excreted

0.67 : conversion factor of m³ CH₄ to kg CH₄

MCF_(jk): methane conversion factor for each MMS j and for each climate region k, %

MMS_(ijk): fraction of total manure from animal species i handled with MMS j and for each climate region k

Bo values were set according to IPCC 2006. The amount of volatile solids (VS) excreted per animal was estimated using the same data that were used to calculate Gross Energy (GE) intake for the determination of the emission factors of CH₄ from enteric fermentation, and using equation 10.24 of the IPCC 2006:

⁴⁵ Volume 4, chapter 10

**Equation 5-7: Volatile solid excretion rates**

$$VS = \{GE * [1 - (DE\%/100)] + (UE*GE)\} * [(1 - ASH) / 18.45]$$

Where:

VS: volatile solids excreted per day on a dry matter basis, kg VS.day⁻¹

GE: daily gross energy intake, Mj.day⁻¹

DE%: digestibility of the feed in percent

(UE*GE): urinary energy expressed as fraction of GE

ASH: the ash content of manure calculated as fraction of the dry matter feed intake

18.45: conversion factor for dietary DE per kg of dry matter, Mj.kg⁻¹

The Table 5-22 presents the values that were used for ash content in manure (ASH) and for the maximum methane production capacity from manure (Bo) for each animal type. VS values change along years as consequence of the change in Gross Energy estimates. For cattle, sheep and goats categories the urinary energy considered was 0.04 of GE.

For equidae (horses, mules and asses) no estimates were done to calculate GE for the determination of the emission factors of CH₄ from enteric fermentation. It was used the default emission factors (Tier1) and so the values of VS in use are also the default ones of table 10A-9 of IPCC2006, 2.13 and 0.94 kg VS.day⁻¹ respectively.

Table 5-22: Parameters used in the estimates of volatile solids and EF per animal category

Animal class	ASH	Bo (m ³ .kg ⁻¹ VS)
Dairy cattle	0.080	0.24
Non-dairy cattle	0.080	0.17
Swine	0.045	0.45*
Sheep	0.080	0.19
Goats	0.080	0.18
Hens	0.048"	0.39
Broilers	0.020"	0.36
Turkeys	0.026"	0.36
Other poultry	0.020"	0.36
Rabbits (per female cage)	0.034"	0.32

All values IPCC default, except: * INIAV, " INRA

Expert guess⁴⁶, based on survey data and field knowledge of technical personnel of the Ministry of Agriculture was used to establish the % of each Manure Management System (MMS) in 1990. The same expertise was used to establish a prevailing trend in the period 1990-2010, considering the practices that are becoming more common and some results of legislation and institutional control.

The 2009 General Agriculture Census (RA09) included in the inquiry to the farmers, for the first time, a question related with the type of manure management system in use on the farm. Based on that information collected from the RA09 and on the information resident in the National Animal Registration database (SNIRA) about the number of livestock produced in extensive mode (pasture), the trend 1990-2010 was

⁴⁶ Information received from Eng. Carlos Pereira, from the Ministry of Agriculture in 3, March 2005, and in 7, October 2009, following update.



updated in September 2017⁴⁷ for cattle (dairy cows, non-dairy cows, other cattle), sheep (ewes, other ovine), goats (does, other caprine) and equidae (horses, mules and asses).

Although the exact year at which the situation changes is unknown, a linear evolution between year 1990 and the target year of 2010 was assumed.

For 2021 we assume the 2010 distribution. In the next submission data between 2011 and 2022 will be updated based on 2019 Agriculture Census information.

The values for the fraction of manure handled in each MMS in 1990 and in 2021 are presented in Table 5-23.

⁴⁷ Information treated, discussed and validated on the Working group involving national experts from the relevant national entities (GPP, INIAV, DGAV, DGADR and IFAP) of the Portuguese Agriculture Ministry, September 2017 (Documento n.º 1/2017/GT SNIERPA Agricultura). The working group is coordinated by GPP which is the inventory National Focal Point for agriculture sector as explained in chapter 1.2 - Institutional arrangements for inventory preparation.



Table 5-23: Share (%) of each Manure Management System per animal type in 1990 and 2021

Animal Type	1990					2021				
	Lagoon system	Tanks/ Earthen pond	Solid storage	Pasture/ range/ paddock	Total	Lagoon system	Tanks/ Earthen pond	Solid storage	Pasture/ range/ paddock	Total
Dairy cows	-	35.0	35.0	30.0	100.0	12.0	25.0	24.0	39.0	100.0
Non-dairy cows	-	-	-	100.0	100.0	-	1.0	6.0	93.0	100.0
Other cattle	-	-	70.0	30.0	100.0	-	2.0	12.0	86.0	100.0
Ewes	-	-	20.0	80.0	100.0	-	-	9.0	91.0	100.0
Other ovine	-	-	20.0	80.0	100.0	-	-	9.0	91.0	100.0
Does	-	-	20.0	80.0	100.0	-	-	11.0	89.0	100.0
Other caprine	-	-	20.0	80.0	100.0	-	-	11.0	89.0	100.0
Sows	80.0	15.0	3.0	2.0	100.0	85.0	6.0	1.0	8.0	100.0
Other swine	80.0	15.0	3.0	2.0	100.0	85.0	8.0	2.0	5.0	100.0
Hens	-	-	100.0	-	100.0	-	-	100.0	-	100.0
Broilers	-	-	99.9	0.1	100.0	-	-	96.0	4.0	100.0
Turkeys	-	-	100.0	-	100.0	-	-	99.9	0.1	100.0
Other poultry	-	-	100.0	-	100.0	-	10.0	90.0	-	100.0
Rabbits	-	-	100.0	-	100.0	-	-	100.0	-	100.0
Equidae	-	-	60.0	40.0	100.0	-	-	11.0	89.0	100.0



Two climate regions occur in Portugal, in accordance with reporting table⁴⁸ classification: temperate (annual average temperature between 15°C and 25°C) and cool (annual average temperature below 15°C). In next Figure is presented the map with the representation of the two climate regions in the mainland territory. Both Archipelagos, Azores and Madeira, are only in one climate region, temperate.

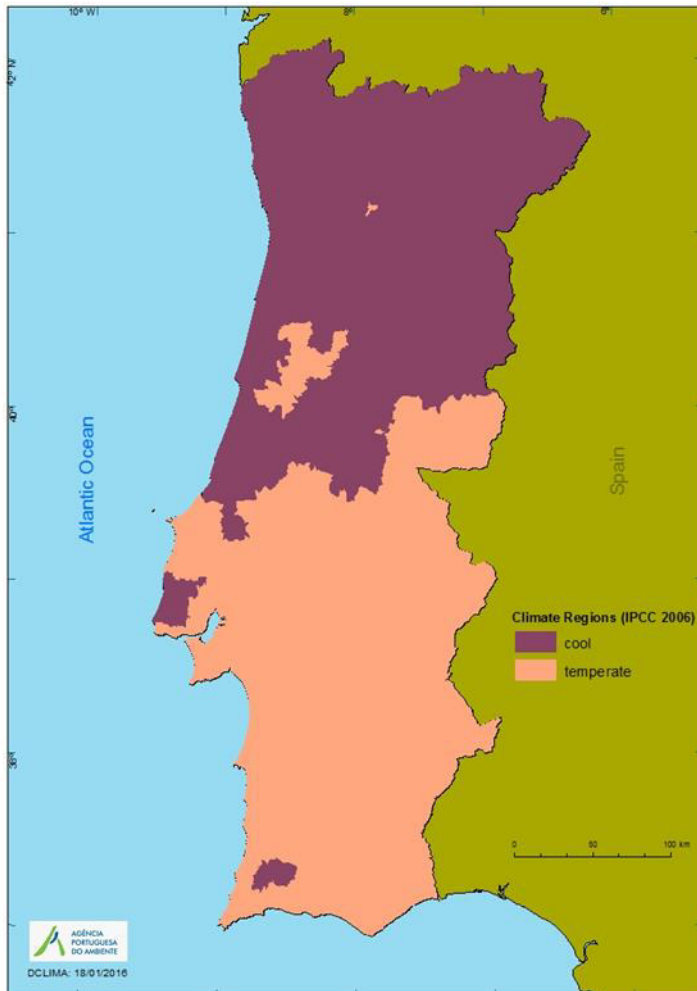

Figure 5-17: Climate regions presentation

Livestock populations living in each climate region were determined according to the following mode:

- the percentage of livestock numbers at each climate region was determined for each *concelho* territorial unit⁴⁹ and for each animal subtype;
- livestock numbers per animal type were available at *concelho* level from three Agriculture General Census (1989, 1999, 2009 and 2019)⁵⁰. Data for 1999, 2009 and 2019 were available for all animal types and subtypes and for 1989 only for dairy cattle, other cattle, ewes, other sheep, female goats and other goats, sows and other swine;

⁴⁸ CRF 3B classification of climate regions is different than IPCC 2006 Guidelines (page 3.39 of volume 4, chapter 3 and page G.11 of the Glossary).

⁴⁹ Concelho territorial unit in Portugal is the designation to land areas associated with one municipal administrative authority. There are 308 *concelhos* in Portugal with an average area of 289 km².

⁵⁰ Recenseamento Geral da Agricultura 1989, Recenseamento Geral da Agricultura 1999 and Recenseamento Agrícola 2009, extensive agriculture census made by INE every 10 years.



- the average annual temperature of each *concelho* area was provided by the national authority in the fields of meteorology and climate, IPMA⁵¹, based on the results of 30 years observations, climatological normal 1971–2000. The classification of each *concelho* in climate region cool or temperate was done according to the respective mean annual temperature provided by IPMA. The same source was used to produce the map above;
- livestock numbers in each *concelho* area were allocated to each climate region, for the years 1999, 2009 and 2019, according to IPMA data and to the Census data for the same territorial unit. For 1989 it was assumed the livestock distribution of each subtype animal equal to 1999 given the unavailability of disaggregated animal information in the 1989 Agriculture Census;
- the information at *concelho* level, number of animals allocated at each climate region, was then grouped at a higher territorial unit level corresponding to NUT II⁵² region. For each NUT II region, based on the data of the set of *concelhos* included in that NUT, was established the share (in %) of animals (by subtype) allocated at each climate region for the years 1989, 1999, 2009 and 2019;
- for the intermediate years, 1990 to 1998, 2000 to 2008 and 2010 to 2018 the animal share (by subtype) allocated to each climate region, result from the interpolation of the values of 1989 and 1999, the values of 1999 and 2009 and the values of 2009 and 2019 respectively;
- livestock population in each climate region and by NUT II was estimated annually from total livestock population in NUT, considering the share values established for the NUT.

For the complete timeseries the percentage of livestock population (by animal subtype) living in cool climate regions, calculated in accordance with the above explained procedure, is presented in ANNEX C: Agriculture.

In Table 5-24, is presented the percentage of national livestock population living in cool climate regions, for major animal types, in 1990 and in 2021.

Table 5-24: Share (%) of livestock population in climate cool region (1990 and 2021)

Animal Type	1990	2021
Dairy Cows	64.4	45.8
Other Cattle	52.9	24.8
Sheep	30.8	29.1
Goats	57.1	56.0
Horses	41.7	39.9
Mules and Asses	68.0	87.9
Swine	46.9	43.4
Poultry	72.8	85.6
Rabbits	80.6	91.4

Methane Conversion Factors (MCF) for each MMS are the default⁵³ ones from IPCC 2006, shown in Table 5-25, considering a mean annual temperature of 17°C for temperate climate region and a mean annual temperature of 14°C for the cool climate region.

⁵¹ IPMA, Instituto Português do Mar e da Atmosfera

⁵² NUT – Nomenclature of territorial units for statistics. There are 7 NUT II regions in Portugal, 5 in mainland Portugal, 1 for whole Archipelago of Azores and 1 for whole Archipelago of Madeira

⁵³ Table 10.17, Volume 4, chapter 10

**Table 5-25: Methane Conversion Factors (MCF), %, for determination of CH₄ emissions from manure management**

MMS Country designation	MCF		Table 10.17* Designation	CRF 3Ba Classification
	Temperate	Cool		
Lagoon system	32	25	Liquid/slurry without natural crust	Liquid system
Tanks/Earthen pond	20	15	Liquid/slurry with natural crust	Liquid system
Solid Storage	4	2	Solid Storage	Solid storage and dry lot
Pasture/range/paddock	1.5	1	Pasture/range/paddock	Pasture/range/paddock

*IPCC 2006, Vol.4, chapter 10

In Table 5-25, it was considered the IPCC equivalent to the national MMS classification. However, there was no additional information or description of the Lagoon system and tanks/earthen ponds that could establish their correspondence with categories liquid/slurry with and without natural crust cover as described in the 2006 IPCC Guidelines. The definition considered for lagoon system in Portugal National Inventory is the one from table 3.13 of Volume 3.B Manure Management of EMEP/EEA air pollutant emission inventory Guidebook 2019 that says “storage with large surface area to depth ratio: normally shallow excavations in the soil”. The terms lagoon, tank/earth ponds are commonly used in Portugal for liquid/slurry manure storage, i.e. manure that is stored as excreta or with a minimal addition of water outside the animal housing, usually for periods less than 1 year (IPCC definition). There are no country-specific manure management systems, but only national classifications aligned, by expert judgment, with the terms and definitions of both Guidelines (2006 IPCC Guidelines and EMEP), in order to ensure coherence, accuracy and completeness of national emission estimates in both inventories.

The emission factors (EF) estimates for all livestock categories and subcategories are presented in the ANNEX C: Agriculture, for the full time series.

In Table 5-26 are shown the implied emission factors (IEF) of methane emissions from Manure Management for each livestock category, expressed in kg CH₄.hd⁻¹.yr⁻¹. The comparison with the default emission factors was done considering the description of the manure management situations that better corresponded to the characteristics of the country manure management, with special focus on the following aspects:

- dairy cows on pasture has a significant expression in Portugal;
- most of non-dairy cattle is kept on pasture (extensive production);
- some traditional swine are kept outdoors and foraging in pasture range;
- daily spread and usage as fuel are practically unknown in Portugal;
- some poultry is kept outside, either in small farms or industrial production of country poultry;
- there are no substantial seasonal variations in the share of management system.



Table 5-26: Manure management CH₄ Implied Emission Factors (IEF) and comparison with IPCC 2006 default emission factors (kg CH₄.hd⁻¹.yr⁻¹)

Animal type	1990	1995	2000	2005	2010	2015	2019	2020	2021	Default*
										(cool-temperate)
Dairy cattle	14.62	15.44	19.19	22.25	24.68	0.00	26.16	26.39	26.47	29-40 (Liquid/slurry and pit storage systems (WE). Portugal also has a significant % of manure directly deposited on pasture. See Table 5-23 of this report)
Non-dairy cattle	2.22	2.29	2.25	2.12	2.02	0.00	1.92	1.92	1.92	1-2 (Non-dairy manure is usually managed as solid and deposited on pastures (NAm). Portugal has the same situation. See Table 5-23 of this report)
Swine	0.41	0.40	0.38	0.34	0.32	0.00	0.33	0.33	0.33	8-15 (Liquid/slurry and pit storage systems are commonly used (WE). Portugal has also 5 to 8 % of swine manure deposited on pasture. See Table 5-23 of this report)
Sheep	0.32	0.31	0.30	0.29	0.27	0.00	0.27	0.27	0.27	0.19-0.28
Goats	3.77	3.42	3.03	2.69	2.30	0.00	2.32	2.34	2.36	0.13-0.20
Horses	1.55	1.41	1.24	1.10	0.93	0.00	0.92	0.90	0.90	1.56-2.34
Mules & Asses	7.98	8.05	8.10	7.99	7.95	0.00	7.52	7.45	7.41	0.76-1.10
Poultry	0.07	0.07	0.07	0.07	0.07	0.00	0.06	0.06	0.06	0.02-0.09
Rabbits ¹	0.27	0.27	0.26	0.26	0.25	0.00	0.25	0.25	0.25	0.08 (The default value is per animal. Emission estimates in Portugal are calculated per female cage. See Table 5-19 and Table 5-23 of this report)

*Table 10.14, page 10.38 (Cattle and Swine); Table 10.15, page 10.40 (Other animal species) and Table 10.16, page 10.41; WE – Western Europe; NA - North America; ¹Per female cage

5.3.4 Activity Data

In a consistent manner livestock numbers are the same that were used in previous source category (CH₄ from enteric fermentation) although for this source category more species are considered in the emissions estimates, namely poultry.

5.3.5 Uncertainty Assessment

Livestock numbers are considered to be the activity data of this source category and the uncertainty values were equal to uncertainty values discussed for CH₄ emissions from Enteric Fermentation, as explained in the previous chapter.

Concerning the uncertainty levels associated with emission factors they were set in the following mode:

- total uncertainty in the emission factor was determined calculating the propagation of error in accordance with the equation that was used for the determination of the Emission Factors and incorporating an additional factor for the uncertainty for the average annual mean temperature of each *concelho* estimated by IPMA;
- uncertainty for the quantity excreted, VS parameter, was set at 20%, considering the use of an enhanced livestock characterization, similar to that used in the derivation of the emission factor of CH₄ from Enteric Fermentation;



- the uncertainty of the allocation of manure for each Manure Management System (MMS) was determined comparing the share patterns that were previously used with the latest revised patterns⁵⁴. This error was combined with the error associated with the MCF parameter: the uncertainty was assumed to be 80 % for Lagoons, given the possible range in the IPCC defaults (IPCC 2006), for Liquid and solid storage and pasture, the uncertainty values of 50% reflect the variation of this parameter;
- the error associated with the parameter B_0 is specie dependent and was establish from the range of possible values in the IPCC 2006, for developed and developing nations. Uncertainty values vary from 10.61% for horses, mules and asses up to 26.74% for non-dairy cattle. The uncertainty of the biogas density was assumed not to be determinant of the overall uncertainty value;
- the evaluation of the errors associated with the territorial distribution of the annual mean temperature was done by IPMA. The values of the standard errors calculated for each *concelho* territorial unit shows that 17.6% of them a change in climate region classification could occur in either direction, cool or temperate, nevertheless the maximum error is always lower than 1°C (0.52°C) Considering the modification that could exert in the percentage of livestock numbers allocated as either in cool or temperate region was assumed 20% as a representative value of uncertainty for this factor.

The individual uncertainty values are presented in Table 5-27.

Table 5-27: Uncertainty values, in %, of the CH₄ Emission Factors of the manure management

Anima Type	Σ MMS*MCF	VS	B_0	Region	EF
Dairy Cows	43.95	20.00	22.92	20.00	57.07
Non-dairy cows	52.33	20.00	26.47	20.00	65.11
Other cattle	58.93	20.00	26.47	20.00	70.52
Sheep	51.75	20.00	15.79	20.00	61.05
Goats	50.59	20.00	21.11	20.00	86.67
Swine	79.16	20.00	13.89	20.00	59.60
Poultry	60.09	20.00	20.83	20.00	69.61
Rabbits	60.99	20.00	20.83	20.00	69.61
Equidae	60.99	20.00	10.61	20.00	68.06

5.3.6 Category specific QA/QC and verification

QA/QC procedures included a series of checks: calculation formulas verification, data and parameters verification, and the information provided in this report.

5.3.7 Category specific recalculations

Differences between submissions are graphically represented in the next figure.

⁵⁴ Although these two patterns are not fully independent, they represent information from two different sources, and could be representative of the range of possible values.

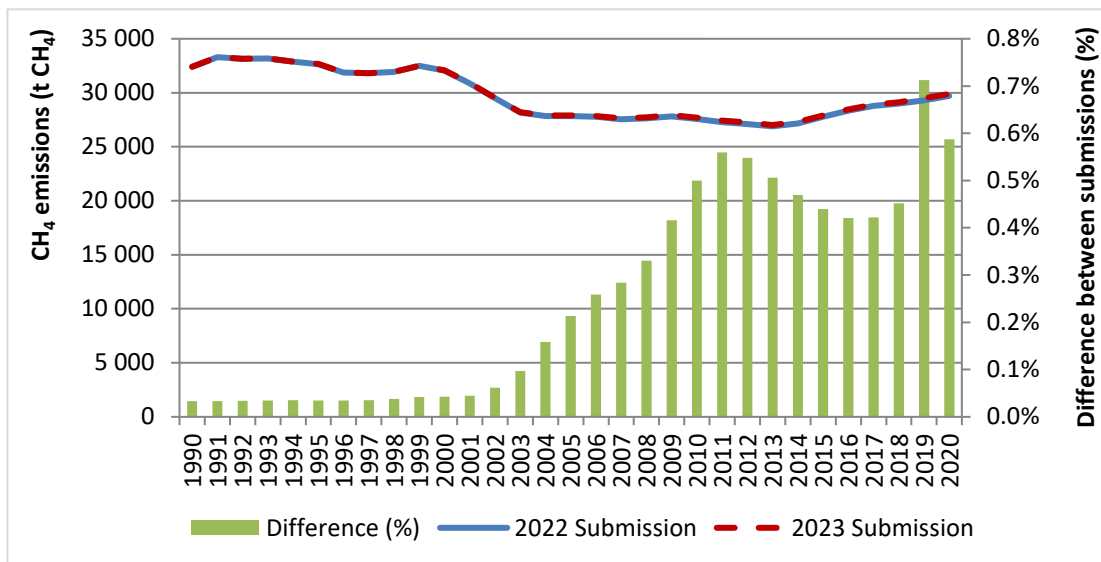

Figure 5-18: Manure management emissions (t CH₄), differences between submissions (2022 and 2023)

The recalculations between submissions are mainly due to activity data update (please check chapter 5.2.7).

5.3.8 Category specific planned improvements

It is planned to continue the improvement of the characterization of the manure management systems framed by the national law⁵⁵ related with livestock farming. Further efforts will be done to obtain more detailed information exploring new sources of information.

5.4 CH₄ Emissions from Rice Cultivation (CRF 3.C)

5.4.1 Category description

Methane production is enhanced in rice cultivation areas (rice paddies) due to the prevalence of anaerobic conditions which result from flooding and high levels of organic material in soil surface. The methane that is formed in soil underwater escapes to atmosphere as greenhouse gas emission, as visible bobbles or trough transport inside plant stems.

In Table 5-28 are presented the estimates of CH₄ emission from rice cultivation.

Table 5-28: CH₄ emissions from Rice cultivation

	1990	1995	2000	2005	2010	2015	2019	2020	2021
Rice cultivation	5.36	4.16	4.70	4.68	5.53	6.03	5.74	4.77	5.79

5.4.2 Methodological issues

Methane emissions from rice production were estimated following the equation 5.1 of IPCC 2006⁵⁶, but simplified because there is no appreciable differentiation in Portugal in what concerns water management regimes or any other conditions that are known to affect emissions from this source sector.

⁵⁵ Decree-Law nº 81/2013

⁵⁶ Volume 4, chapter 5



Original formula was therefore simplified to:

Equation 5-8: CH₄ emissions from Rice cultivation

$$E_{\text{RiceCH}_4(y)} = EF * \text{RiceArea}(y) * 10^{-3}$$

Where:

$E_{\text{RiceCH}_4(y)}$: emission from rice production estimated for year y, t CH₄.yr⁻¹

EF: final emission factor seasonally integrated and adjusted for management practices, kg CH₄ ha⁻¹ yr⁻¹

$\text{RiceArea}(y)$: area under rice cultivation in year y, ha

5.4.3 Emission Factors

According to equation 5.2 of IPCC 2006⁵⁷, the final value for the emission factor results from the multiplication of several scaling factors:

Equation 5-9: Emission factor, seasonally integrated and adjusted, for rice cultivation

$$EF = EF_{\text{ct}} * SF_{\text{w}} * SF_{\text{p}} * SF_{\text{o}} * SF_{\text{s}}$$

Where:

EF: final emission factor seasonally integrated and adjusted for management practices, kg CH₄ ha⁻¹ yr⁻¹

EF_{ct} : baseline emission factor for continuously flooded fields without organic amendments, for the cultivation period of rice, kg CH₄ ha⁻¹ yr⁻¹

SF_{w} : scaling factor for water management regime during the cultivation period of rice

SF_{p} : scaling factor to account for the differences in water regime in the pre-season before the cultivation period

SF_{o} : scaling factor for the type of organic amendment applied (rice straw, manure, compost, wastes), because easily decomposable carbon increase methane formation

SF_{s} : scaling factor for soil type

EF_{ct}:

The default daily baseline emission factor, 1.30 kg CH₄ ha⁻¹ yr⁻¹, proposed in Table 5-11⁵⁸ of IPCC 2006, is the most appropriate to use in Portugal⁵⁹ because a country specific EF_{c} sufficiently robust was not yet determined. The cultivation period of rice in Portugal has, in average, duration of 153 days.

SF_w and SF_p:

Rice cultivation has a long-time tradition in Portugal with homogeneous practices in all national territory. In Figure 5-19 are shown the main cultural practices usually done during the rice growing season.

⁵⁷ Volume 4, chapter 5, page 5.48

⁵⁸ Volume 4, chapter 5, page 5.49

⁵⁹ José Pereira et al.(2013) – “Effects of elevated temperature and atmospheric carbon dioxide concentration on the emissions of methane and nitrous oxide from Portuguese flooded rice fields”. Atmospheric Environment 80, 464-471



The culture is produced in a controlled flooding system with some aeration periods. The first aeration period occurs after rice germination to promote the rooting of the plants. Fields are drained for one week or more (7 to 10 days).

The second aeration period (or periods, it could be more than one) is done for weed control and it last only 2 or 3 days. A third and final aeration takes place to create dry conditions for harvest. Water regime is controlled by human activity (water diversion, irrigation and dikes). All areas under rice cultivation are situated close to river banks almost at sea level (lowland). In accordance with IPCC 2006 classification the water management regime for rice cultivation in Portugal is classified as intermittently flooded – single aeration (only one aeration period of more than 3 days, not including final aeration). Considering all the aspects described the value for parameter SF_w was set as 0.60 based on Table 5.12 of IPCC 2006, and for parameter SF_p the value considered was 0.68 (table 5.13, IPCC 2006).

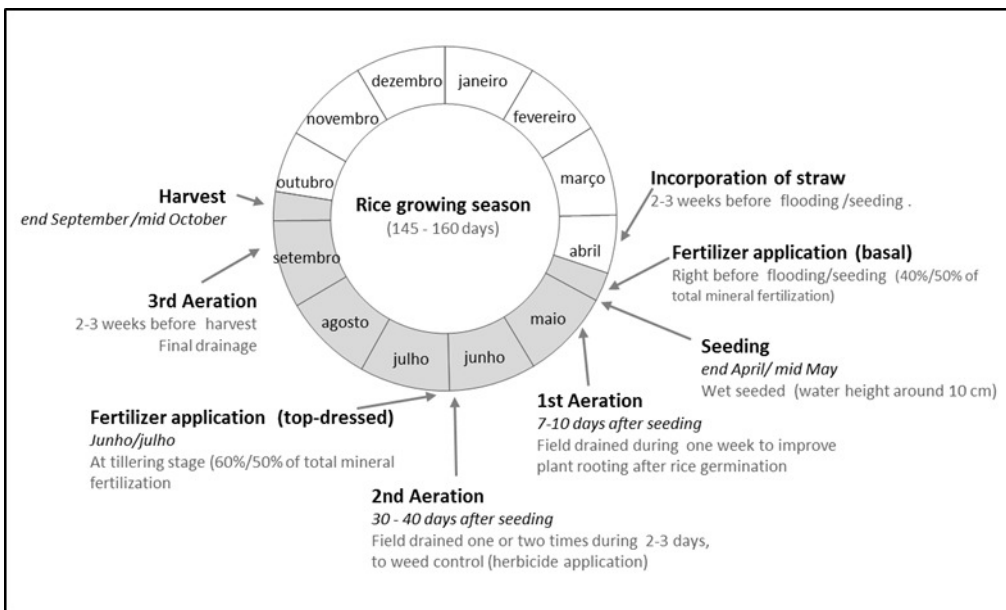

Figure 5-19: Rice cultivation relevant practices for EF calculation

SF_o :

Commonly the major fraction of rice stubbles and straw are burnt in the fields. Nevertheless, the practice of incorporating straw into the soil often occurs too with special relevance on rice producing areas inside Natura 2000⁶⁰ limits. In these situations, the practice of burning crop residues is forbidden⁶¹, for reasons of conservation of natural habitats and animal species, since 2000 until nowadays.

Straw is left on ground and incorporated into soil by ploughing before next crop season.

⁶⁰ Natura 2000 network includes Special Zones for Conservation (ZPC) established under Habitats Directive (92/43/ CEE) and Special Protection Zones (ZPE) established under Birds Directive (last revision 2009/147/CE).

⁶¹ National Laws: DL 140/99 artº 11º (revised by DL 49/2005); RCM 177/2008 artº 21º; RCM 182/2008 artº 8º.



The next figure shows the evolution of rice cultivation areas where the practice of residues burnt is not allowed.

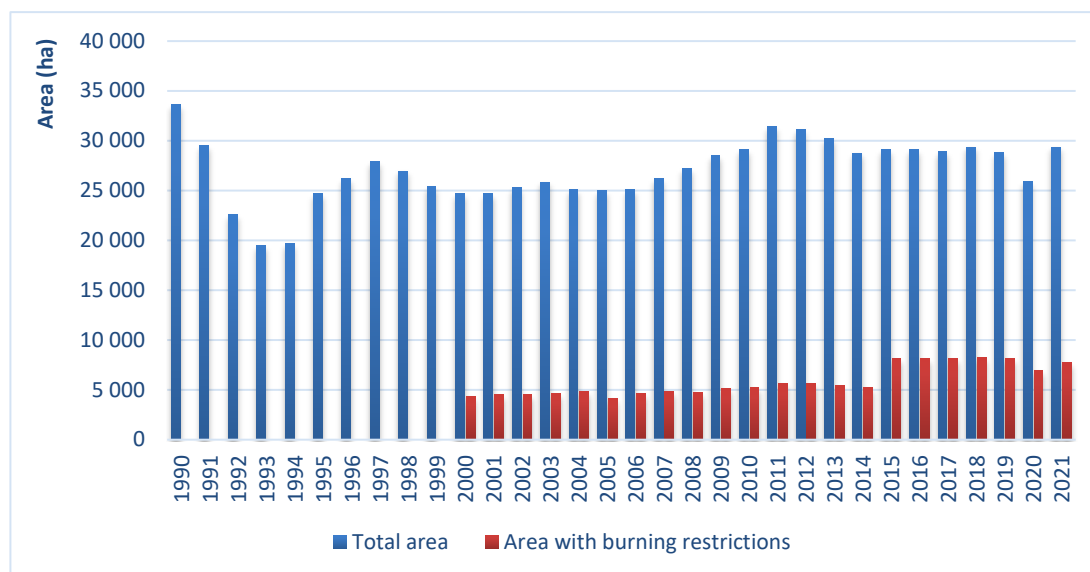

Figure 5-20: Rice area cultivated in Portugal, ha

Due to the above described, the amount of straw annually incorporated into the soil has variations along the time series, from a minimum of 2.13 t dm/ha to a maximum of 4.17 t dm/ha. The scaling factor Sf_o , for organic amendment applied, was determined using the equation 5.3⁶² of IPCC 2006, where the conversion factor (CFOA) took the value of one, corresponding to straw incorporated shortly before cultivation (<30 days), in accordance with default value of Table 5.14⁶³.

SF_s:

Finally, no information is available to establish the influence of soil type and SF_s was set to one.

In Table 5-29 are summarized the parameters and emissions factors used to estimate methane emissions from rice cultivation in Portugal, for the full time series.

Table 5-29: Parameters and Emission Factors used to calculate CH₄ emissions from rice paddies in Portugal

Year	EF _{ct}	SF _w	SF _p	SF _o	SF _s	EF
	kg CH ₄ ha ⁻¹ yr ⁻¹					kg CH ₄ ha ⁻¹ yr ⁻¹
1990	198.9	0.6	1.96	1.00	0.68	159.24
1995	198.9	0.6	2.08	1.00	0.68	168.53
2000	198.9	0.6	2.34	1.00	0.68	190.26
2005	198.9	0.6	2.31	1.00	0.68	187.36
2010	198.9	0.6	2.34	1.00	0.68	190.05
2015	198.9	0.6	2.55	1.00	0.68	206.89
2019	198.9	0.6	2.45	1.00	0.68	198.97
2020	198.9	0.6	2.26	1.00	0.68	183.72
2021	198.9	0.6	2.43	1.00	0.68	197.25

⁶² Volume 4, chapter 5, page 5.50

⁶³ Volume 4, chapter 5, page 5.51



5.4.4 Activity Data

Rice cultivated area is available from annual statistics from National Statistical Institute, which time series is presented in Figure 5-20. It is noticeable the existence of significant variations in annual rice paddy areas, expressing annual variations in hydrological conditions. There is only one rice crop per year.

5.4.5 Uncertainty Assessment

For activity data, the standard deviation of inter-annual area under rice cultivation was considered: 10.2%.

Total uncertainty in the emission factor was determined calculating the propagation of error in accordance with the equation that was used for the determination of the Emission Factor:

- the error associated with the parameters SF_w and SF_p were established from the range of possible errors for each scaling factor (IPCC 2006);
- the error associated with the scaling factor SF_o was obtained by the combination of the uncertainties of the parameters ROA and CFOA and the exponent of the SF_o equation;
- the error associated with the baseline Ef_{ct} was obtained from the range of possible error values.

The individual uncertainty values are presented in Table 5-30.

Table 5-30: Uncertainty values (in %) of the Emission Factor of CH₄ emissions from rice cultivation

SF_w	SF_p	Sf_o	Ef_{ct}	EF
28.3	16.2	8.5	53.8	63.5

5.4.6 Category specific QA/QC and verification

QA/QC procedures included a series of checks: calculation formulas verification, data and parameters verification, and the information provided in this report.

5.4.7 Category specific recalculations

There is a decrease in CH₄ emissions in the period 2003-2008 and an increase in the period 2015-2020 (Figure 5-20).

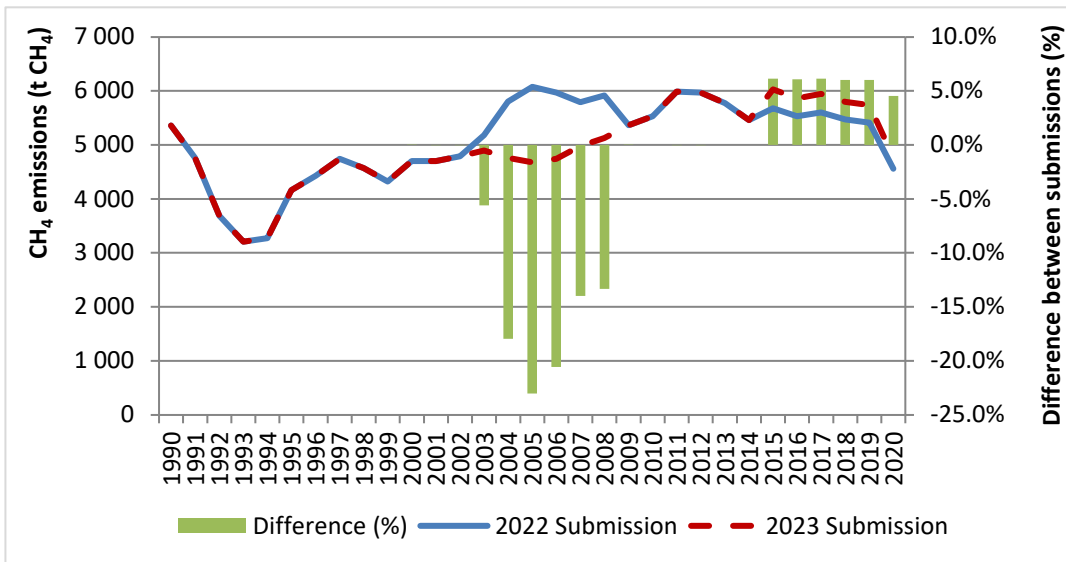

Figure 5-21: Rice cultivation emissions (t CH₄), differences between submissions 2022 and 2023

The differences are due to a correction of rice area with burning restrictions (Figure 5-22), which affects the SF₀ (scaling factor for the type of organic amendment applied) value and consequently CH₄ emissions.

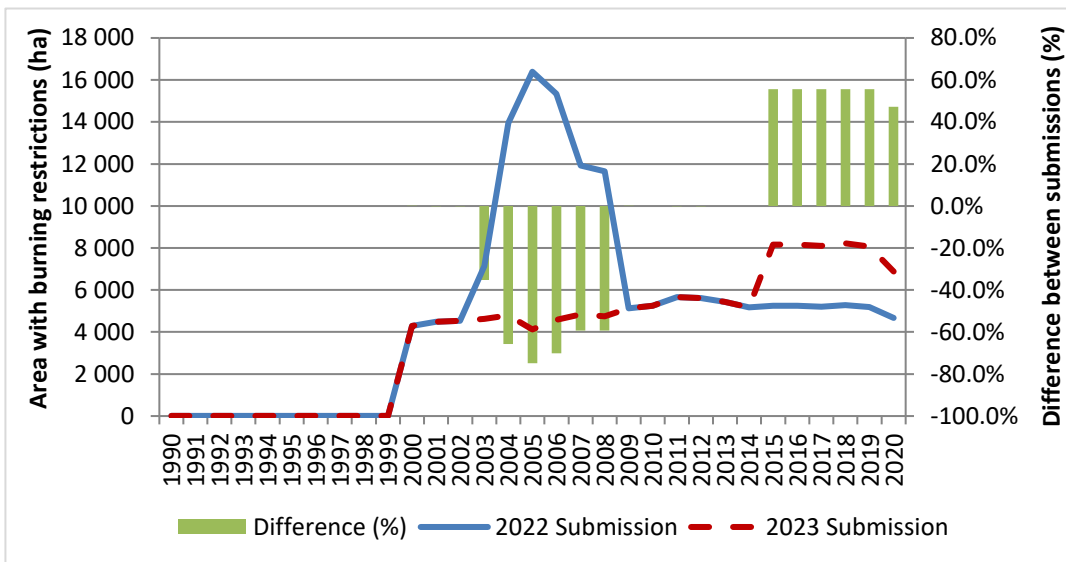

Figure 5-22: Rice area with burning restrictions (ha), differences between submissions 2022 and 2023

5.4.8 Category specific planned improvements

No further improvements planned.

5.5 N₂O Emissions from Manure Management (CRF 3.B.b)

The estimates of total N₂O emissions from manure management, direct and indirect emissions, are presented in Table 5-31. In the following chapters 5.5.1 – Direct N₂O emissions from manure management and 5.5.2 – Indirect N₂O emissions from manure management, further details will be developed.

**Table 5-31: N₂O emissions from manure management (kt)**

Livestock type	1990	1995	2000	2005	2010	2015	2019	2020	2021
Direct emissions	0.54	0.49	0.50	0.40	0.36	0.33	0.41	0.43	0.44
Dairy cattle	0.19	0.17	0.18	0.14	0.11	0.11	0.11	0.11	0.11
Non- dairy cattle	0.08	0.07	0.06	0.06	0.05	0.05	0.06	0.06	0.06
Sheep	0.04	0.04	0.03	0.02	0.01	0.01	0.01	0.01	0.01
Swine	0.04	0.03	0.03	0.02	0.01	0.01	0.01	0.01	0.01
Goats	0.01	0.01	0.00	0.00	0.00	0.00	0.00	0.00	0.00
Horses	0.01	0.01	0.01	0.00	0.00	0.00	0.00	0.00	0.00
Mules and asses	0.01	0.01	0.00	0.00	0.00	0.00	0.00	0.00	0.00
Poultry	0.14	0.14	0.17	0.13	0.15	0.13	0.20	0.22	0.23
Rabbits	0.03	0.03	0.02	0.02	0.02	0.01	0.01	0.01	0.01
Indirect emissions	0.36	0.35	0.35	0.29	0.27	0.26	0.30	0.30	0.30
Total	0.90	0.84	0.85	0.69	0.63	0.59	0.71	0.73	0.74

Note: Totals may not sum due to independent rounding

5.5.1 Direct N₂O Emissions from Manure Management

5.5.1.1 Category description

Part of the Nitrogen (N) that is in manure, either in faeces or urine is emitted as N₂O during management or during storage of manure, before application to soil, as consequence of the nitrification-denitrification processes affecting ammonia nitrogen.

Emissions of N₂O that occur during manure application on soil and urine and dung deposited directly into soil by grazing are reported in the category N₂O from managed soils (CRF 3D) following the UNFCCC reporting guidelines.

In a short description, this is a biological based process where emission of N₂O from manure require the previous oxidation of organic nitrogen in ammonia form, which results from bacterial mineralization of organic nitrogen, into nitrites and nitrates (nitrification, a biological process mediated by bacteria such as Nitrobacter and Nitrosomonas) in an aerobic environment and, thereafter, the reduction of this compounds in an anaerobic environment (the denitrification process where nitrate is converted to N₂ and nitrous oxide).

In terms of the relevance by Manure Management System, observable in Figure 5-23, the great majority of emissions result from solid storage totalizing in 2021, 82.8% of direct N₂O emissions from Manure Management. The remaining 17.2 % N₂O emissions are from liquid systems. In terms of origin by animal type, emissions are dominated by poultry 52.2% and cattle 37.6% (dairy – 24.3%, non-dairy – 13.3%), which together comprehend about 89.8% of total N₂O direct emissions for the year 2021, as can be seen in Figure 5-24.

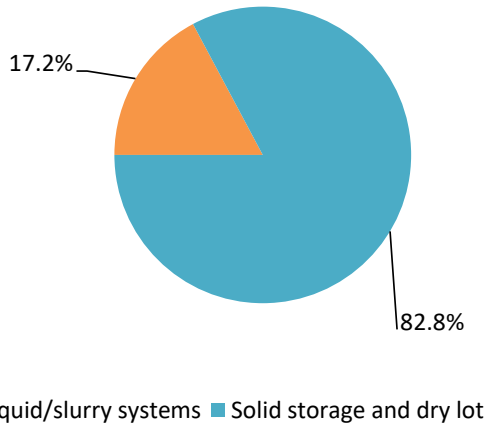

Figure 5-23: Direct N₂O emissions from manure management, per system, 2021

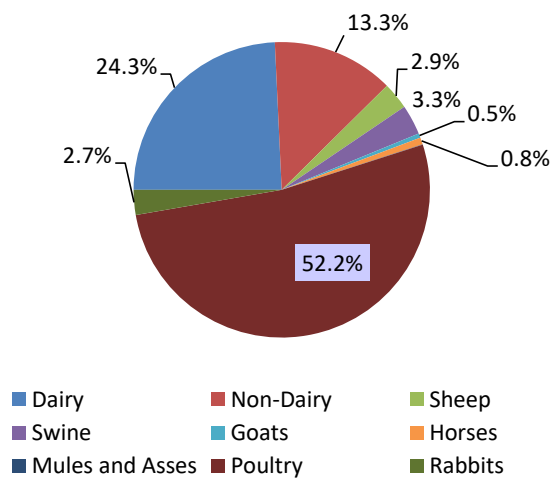

Figure 5-24: Direct N₂O emissions from manure management by livestock category, 2021

5.5.1.2 Methodological issues

Direct N₂O emissions from manure for each Manure Management System (MMS) were estimated from the following equation:

Equation 5-10: N₂O direct emissions from manure management, per system

$$EN_{2O(s)} = \sum_i [N_{(i)} * Nex_{(i)} * MS_{(i,s)}] * EF_{3(s)} * 44/28$$

Where:

EN_{2O(s)}: direct N₂O emissions from manure in manure management System s, kg N₂O.yr⁻¹

N_(i): number of individuals from livestock species/category i in the country, head

Nex_(i): annual average N excretion per head of the species/category i, kg N.head⁻¹.yr⁻¹

MS_(i,s): fraction of manure Nitrogen from livestock species/category i that is managed in manure management System s, %

EF_{3(s)}: N₂O emission factor for Manure Management System s, kg N₂O – N.kg N⁻¹ in manure

s: manure management system

i : species/category of livestock

44/28: conversion of (N₂O – N) emissions to N₂O emissions



Total N₂O emissions result from the sum of the estimated emissions for each manure management system considered. This formulation follows the one proposed in IPCC 2006 (equation 10.25)⁶⁴.

Manure Management Systems are the same that were used to estimate methane emissions from manure management (Table 5-23 of Chapter 5.3.3 of this report).

N₂O emissions from manure deposited in soil during grazing (Pasture/range/paddock) are further discussed in 5.6 - "Direct N₂O Emissions from Managed Soils".

Parameters $N_{(i)}$, $N_{ex(i)}$ and $MS_{(i,s)}$ will be discussed under "activity data" and $EF_{3(s)}$ will be discussed as "emission factor".

5.5.1.3 Emission factors

N₂O emission factors for the MMS in use are the default IPCC 2006 emission factors (table 10.21)⁶⁵ and are presented in Table 5-32.

Table 5-32: N₂O emission factors per manure management system

MMS	EF ₃ (kg N ₂ O-N.kg N ⁻¹)	Table 10.21*	CRF 3Bb
Lagoon system	0.000	Liquid/slurry without natural crust	Liquid system
Tanks/ Earthen pond	0.005	Liquid/slurry with natural crust	Liquid system
Solid Storage	0.005	Solid Storage	Solid storage and dry lot

*IPCC 2006, Vol.4, chapter 10

5.5.1.4 Activity Data

The livestock population numbers used to estimate total nitrogen excretion are the same as those used to estimate emissions of CH₄ from Enteric Fermentation and CH₄ from Manure Management that have already been presented in the chapter concerning CH₄ emissions from Enteric Fermentation.

Most of the nitrogen excretion rates (N_{ex}) used in the inventory were established based on the N_{ex} proposed by the Revised Code of Good Agricultural Practice⁶⁶ (CBPA).

The following chapters present the methodology used to establish the country specific N_{ex} for dairy-cattle (which vary with milk production) and for estimates of nitrogen excreted by non-dairy cattle. For all other animals, nitrogen excretion rates were based on CBPA N_{ex}, considering animal species, age and sex, according to the livestock characterization used in the inventory.

a) Dairy Cattle N_{ex}

CBPA defines the nitrogen excretion rate of dairy-cattle as a function of milk production. The base nitrogen value for dairy-cattle is 115 kg N.hd⁻¹.yr⁻¹ for 7000 kg milk produced.hd⁻¹.year⁻¹. For different milk production values, the extrapolation procedures defined in CBPA are the following:

- the N_{ex} decreases 10 % for every 1000 kg less of milk production;
- the N_{ex} increases 2 % for every 1000 kg extra of milk production.

⁶⁴ Volume 4, chapter 10, page 10.54

⁶⁵ Volume 4, chapter 10, pages 10.62 and 10.63

⁶⁶ Portugal published his first CBPA in 1997. In 2010 it was revised and recently it was published including not only good practices to follow in nitrogen fertilization of crops but also the good practices for phosphate fertilization (Despacho nº 1230/2018, 5th February)



Milk production values and corresponding Nex in the time series are presented in Table 5-33.

Table 5-33: Nitrogen excretion rates (Nex) of dairy cows in the time series

Year	Milk per Cow	Nex
	(kg. hd ⁻¹ .year ⁻¹)	(kg. hd ⁻¹ .year ⁻¹)
1990	4 464	85.8
1995	4 556	86.9
2000	6 262	106.5
2005	7 233	115.5
2010	7 886	117.0
2015	8 287	118.0
2019	8 442	118.3
2020	8 571	118.6
2021	8 644	118.8

The 2021 Nex value of 118.8 kg. hd⁻¹.yr⁻¹ is higher than the default IPCC 2006 value of 105.1 kg. hd⁻¹.yr⁻¹ for Western Europe (table 10.19⁶⁷ considering an average weight of 600 kg per dairy cow), but is close to those used by other countries.

b) Non - Dairy Cattle Nex

The Nex estimates for non-dairy cattle subcategories were calculated in coherence with the review done to the emission factors from enteric fermentation, using IPCC 2006 equations 10.31, 10.32 and 10.33⁶⁸. The values used of gross energy (GE), weight gain (WG), net energy for growth (NEg), milk production and fat content of milk, are the same that were calculated and described in chapter 5.2.3 of this report. The percent crude protein in the representative diets were estimated by the expert⁶⁹ of INIAV⁷⁰ on Chemical and Nutritive evaluation of Animal Feed, considering the proportion and the data of the different feed constituents of each diet. In Table 5-34 are presented the weighted average values of Nex by subcategory of non-dairy cattle, for the time series.

Table 5-34: Nitrogen excretion rates (Nex) of non-dairy cattle in the time series

Non-dairy cattle subcategories	Nex (kg. hd ⁻¹ .year ⁻¹)									
	1990	1995	2000	2005	2010	2015	2019	2020	2021	
Beef calves (<1 yr)	25.0	25.0	24.8	24.3	23.7	23.4	23.4	23.4	23.4	
Calves M.Rep. (<1 yr)	25.0	25.0	27.1	32.5	37.8	41.0	41.0	41.0	41.0	
Calves F Rep. (<1 yr)	25.0	25.0	27.1	32.5	37.8	44.8	44.8	44.8	44.8	
Males 1-2 yrs	40.0	40.0	42.6	49.1	55.5	59.4	59.4	59.4	59.4	
Beef Fem. 1-2 yrs	40.0	40.0	41.7	45.9	50.0	52.5	52.5	52.5	52.5	
Females rep. 1-2 yrs	40.0	40.0	41.8	46.5	51.1	53.9	53.9	53.9	53.9	
Steers (>2 yrs)	41.0	41.0	47.7	64.4	81.1	91.1	91.1	91.1	91.1	
Heifers Beef (>2 yrs)	55.0	55.0	55.7	57.6	59.4	60.5	60.5	60.5	60.5	
Heifers rep. (>2 yrs)	55.0	55.0	55.7	57.6	59.4	60.5	60.5	60.5	60.5	
Non-dairy cows	80.0	80.0	78.7	75.3	71.9	69.9	69.9	69.9	69.9	

⁶⁷ Volume 4, chapter 10, page10.59

⁶⁸ Volume 4, chapter 10, pages 10.58 and 10.59

⁶⁹ Eng^a Teresa Dentinho – “Dados portugueses para determinação das emissões de azoto de bovinos não leiteiros – Valor proteico das dietas”.

⁷⁰ National Institute of Agrarian and Veterinary Research



The average Nex, weighted by the 2021 non-dairy cattle population is 55.9 kg. hd⁻¹.yr⁻¹, which is higher but close of the default value for Western Europe (considering the average weight of 441.5 kg of the non-dairy cattle population in 2021).

c) Nex for all livestock categories other than cattle

Table 5-35 presents the nitrogen excretion rates applied in the estimation of N₂O emissions from Manure Management and the defaults Nex, estimated with equation 10.30⁷¹ as proposed in the IPCC 2006. There is an acceptable agreement between country-specific values and IPCC defaults for all species other than sheep and goats. For these two categories the nitrogen excretion rate appears to be low, when in comparison to IPCC default, but it has similarities to those used by other parties.

Table 5-35: Nitrogen excretion rates (Nex) of all livestock other than cattle

Animal type	Sub category	Nex			
		Country specific (kg N.hd ⁻¹ .yr ⁻¹)	IPCC default		
			Typical animal mass (average) (kg)	Kg N (1000 kg animal mass) ⁻¹ .day ⁻¹	Kg N hd ⁻¹ .yr ⁻¹
Swine	Piglets (<20 kg)	0.00	65	0.51	12.10
	Fatt. Swines (20-50 kg)	9.00			
	Fatt. Swines (50-80 kg)	13.00			
	Fatt. Swines (80-110 kg)				
	Fatt. Swines (> 110 kg)	18.0	205	0.42	31.43
	Boars (>50 kg)				
	Sows, pregnant				
	Sows, non-pregnant	42.0			
Sheep	Ewes	9.17	54	0.85	16.75
	Other Ovine	6.60			
	Lambs	0.00			
Goats	Does	7.00	30	1.28	14.02
	Other Caprine	6.60			
	kids	0.00			
Equidae	Horses	44.0	550	0.26	52.20
	Asses & Mules	22.0	245		23.25
Poultry	Hens, reproductive	0.34	1.8	0.96	0.63
	Hens eggs	0.80			
	Broilers	0.45	0.9	1.10	0.36
	Turkeys	1.40	6.8	0.74	1.84
	Other poultry	0.45	2.7	0.83	0.82
Other	Rabbits ¹	9.00	-	-	8.10

¹Per female cage

Values for Piglets (< 20kg), lambs and goat kids, are 0 kg N.hd⁻¹.yr⁻¹ because the Nex is included in the Nex of their respective mothers.

⁷¹ Volume 4, chapter 10, page10.57



The Nex values for rabbits correspond to a breeding female with 40 young animals with a final weight of 2.7/3.0 kg per rabbit per year.

There is an acceptable agreement between country-specific values and IPCC 2006 defaults for all species other than sheep and goats. These two categories nitrogen excretion rate appears to be low, when in comparison with default values, but it has similarities to those used by other parties.

The total quantity of nitrogen in manure produced (including deposition on pasture) per animal type, and its annual variation in the period 1990 to 2021, is presented in the ANNEX C: Agriculture. For the year of 2021 the distribution of N manure by manure management system and deposition on pasture is shown in Figure 5-25. The major contributors to total nitrogen from livestock manure in Portugal in 2021 were non-dairy cattle and dairy cattle, as may be seen in Figure 5-26.

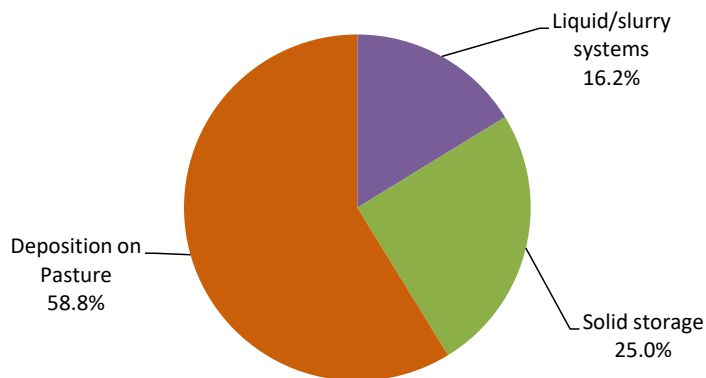

Figure 5-25: Distribution of total nitrogen in manure produced in 2021 (%)

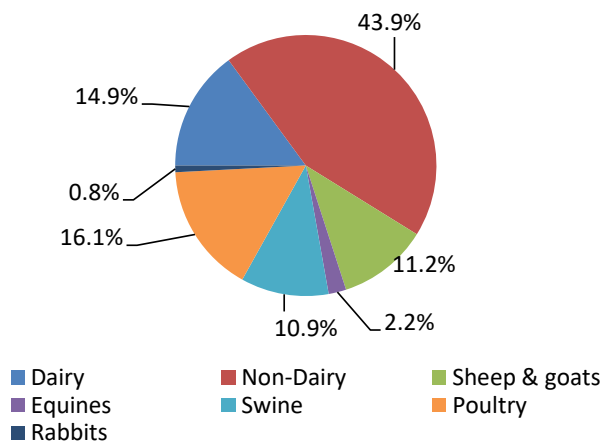

Figure 5-26: Origin of total nitrogen in manure produced in 2021, per animal type

The N₂O emissions estimates from urine and dung directly deposited on pasture are included in chapter 5.6 N₂O Emissions from Managed Soils (CRF 3.D), and so the annual amount of nitrogen that constitutes activity data for estimation of those emissions will be further discussed there.

The percentage of nitrogen in manure stored and treated, per manure management system, is presented in the next Figure for the year 2021.

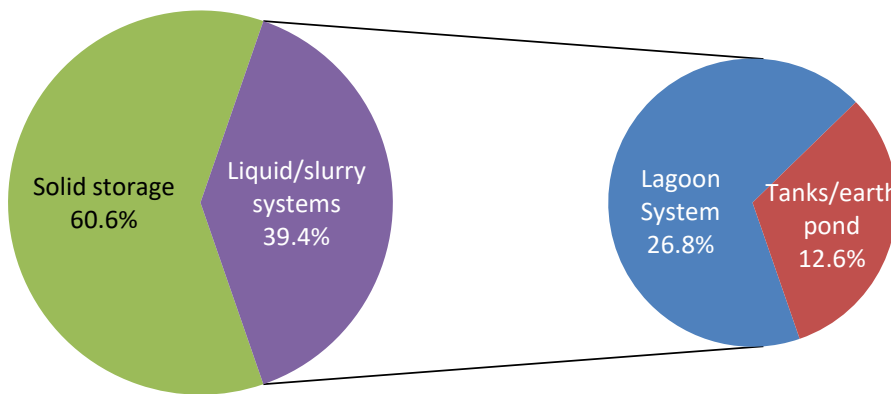

Figure 5-27: Share of nitrogen in manure stored and treated per MMS, in 2021

The major contribution for stored and treated manure in 2021, were poultry, swine and dairy cattle, as it is shown in the next Figure.

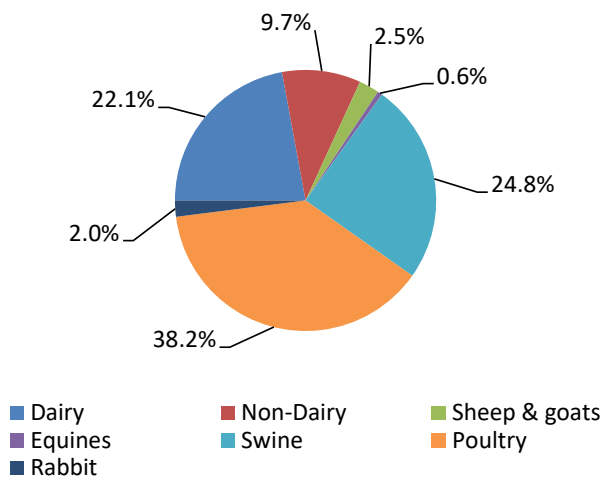

Figure 5-28: Origin, by livestock category, of nitrogen in manure stored and treated in 2021

The percentage of manure that is attributed to each Manure Management System and to deposition on pasture was established in a coherent mode with the share considered for CH₄ emissions from Manure Management (Table 5-23 of this report).

5.5.1.5 Uncertainty Assessment

Uncertainty in activity data is the result of the combined uncertainties in livestock number, nitrogen excretion rates and the distribution by each manure management system. The values for uncertainty in livestock numbers are the same that were for sector CH₄ emissions from enteric fermentation. The uncertainty in N-excretion rate was set at 37.5%, considering an intermediate situation between the uncertainty values recommended by IPCC 2006 for default N-excretion rates (50%) and the lower uncertainty when country-specific values are based on accurate national statistics (25%). Uncertainty in MMS share was determined as the maximum difference in total excretion for each MMS considering the previous allocation per MMS used, and the last revised share of MMS. Individual values and the overall uncertainty values for activity data are presented in Table 5-36.

**Table 5-36: Uncertainty values (in %) of the activity data for N₂O emissions from manure management**

Animal type	Livestock numbers	N _{ex}	MMS allocation	Total U_AD
Dairy cattle	1.19	37.50	38.00	53.05
Non- dairy cattle	3.47	37.50	38.00	53.15
Sheep	0.59	37.50	38.00	53.04
Goats	6.04	37.50	38.00	53.38
Swine	7.46	37.50	38.00	53.56
Poultry	15.03	37.50	38.00	55.12
Rabbits	20.00	37.50	38.00	56.68
Equidae	7.82	37.50	38.00	53.61

The uncertainty of N₂O emission factor was set from the error range considered in IPCC 2006, resulting 75% for all MMS.

5.5.2 Indirect N₂O Emissions from Manure Management

5.5.2.1 Category description

Indirect N₂O emissions result from volatile nitrogen losses, in forms of NH₃ and NO_x, during manure collection and storage and from nitrogen lost through runoff and leaching into soil from solid storage of manure. Nitrogen losses begin at the point of excretion on houses and continue through on-site management in storage systems.

The contribution of N losses from volatilization and from leaching and runoff to indirect N₂O emissions from manure management is shown in the next Figure for the 2021 year.

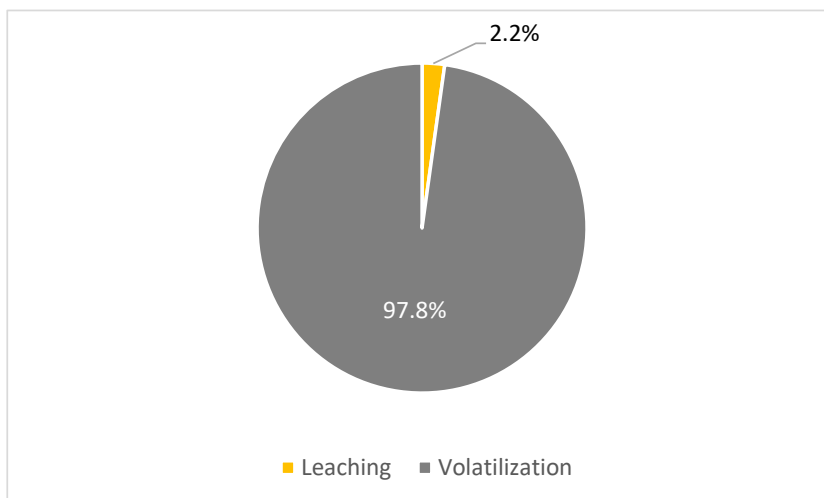
**Figure 5-29: Relative importance of the losses of volatile nitrogen and of leached nitrogen from manure management systems, in 2021**

5.5.2.2 Methodological issues

Indirect N₂O emissions were estimated with equation 10.27⁷² (IPCC 2006), in the case of the N lost due to volatilization, and with equation 10.29⁷³ (IPCC 2006) for the indirect N₂O emissions due to N manure leached from manure management systems.

⁷² Volume 4, chapter 10, page 10.56

⁷³ Volume 4, chapter 10, page 10.57



5.5.2.3 Emission Factors

Emission factors used were the default emission factors, EF₄ (volatilization) and EF₅ (leaching), both from table 11.3⁷⁴ of IPCC 2006.

5.5.2.4 Activity Data

The amount of N that is lost due to volatilization, in form of NH₃ and NO_x, during animal housing and storage and treatment of the manure, was estimated using mass flow approach described in the EMEP/EEA Guidebook 2019, chapter 3B – Manure management, in coherence with UNECE/CLRTAP emissions inventory.

Portugal has no country specific value for the N fraction leached into soil from liquid/slurry or solid storage manure. The national legislation⁷⁵ requires that the storage of liquid/slurry manure is in containers with waterproof bottom. The solid storage should have the concrete or similar materials on the bottom and the leachate collection system. Nevertheless, manure heaps near the field are permitted for limited time after storage aimed at spreading. Leaching of N during manure management is thus restricted to these manure heaps after storage. On the basis of that information Fra_{CLeachMMs} is assumed equal to 1%, the lower bound of the typical range of IPCC 2006.

The amount of N lost due to volatilization and due to leaching and runoff for the time series is presented in Table 5-37.

Table 5-37: Amount of N lost due to volatilization (NH₃+NO_x) and leaching, during animal housing and manure storage (t N.yr⁻¹)

Year	Volatilization	Leaching
1990	22 552	530
1995	21 682	486
2000	22 082	491
2005	18 161	395
2010	17 097	360
2015	16 227	325
2019	19 183	424
2020	19 875	449
2021	20 155	461

5.5.2.5 Uncertainty Assessment

The uncertainty of activity data is the same discussed in direct N₂O emissions. Emission factors uncertainties were set based on the error ranges referred in IPCC2006. Given that, the uncertainty of EF₄ was estimated in 135.0% and the uncertainty of EF₅ in 163.3%.

5.5.3 Category specific QA/QC and verification

For this source category QA/QC procedures included the comparison between inventory Nex values and the corresponding IPCC default and a series of checks: calculation formulas verification, data and parameters verification and the information provided in this report.

⁷⁴ Volume 4, chapter 11, page 11.24

⁷⁵ Decreto-Lei nº 81/2013, of June 14, and Portaria 631/2009, of June 9, with the change introduced by the Portaria 114-A /2011, of March 23



5.5.4 Category specific recalculations

Differences between submissions are graphically represented in the next figure.

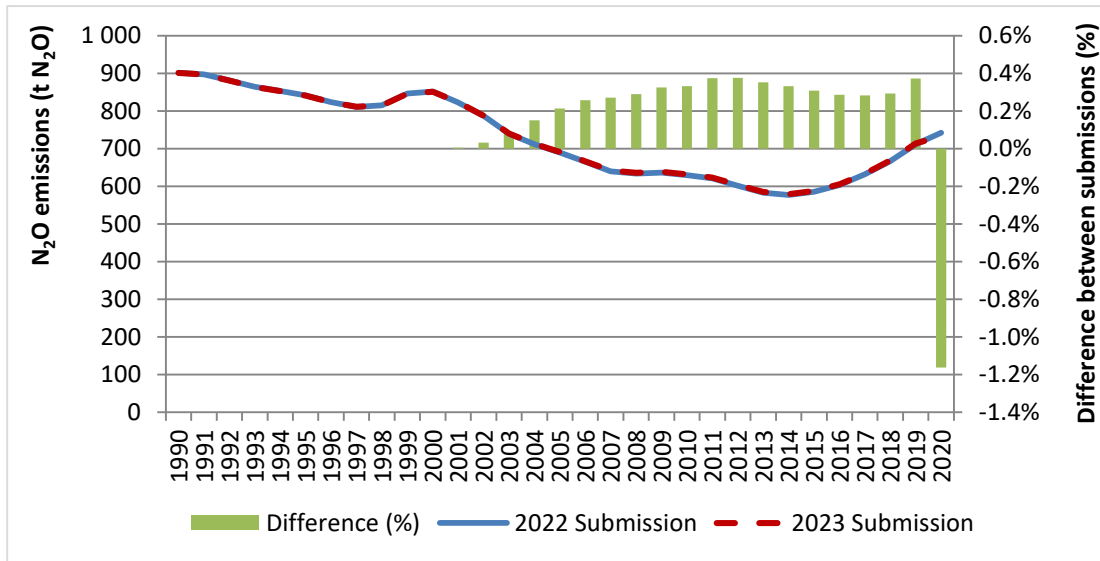

Figure 5-30: N₂O emissions (direct and indirect) from manure management (t N₂O). Differences between 2022 and 2023 submissions

The recalculations between submissions are mainly due to activity data update (please check chapter 5.2.7).

5.5.5 Category specific planned improvements

It is planned to continue the improvement of the characterization of the manure management systems framed by the new national law⁷⁶ related with livestock farming. Further efforts will be done to obtain more detailed information exploring new sources of information.

5.6 N₂O Emissions from Managed Soils (CRF 3.D)

The estimates of total N₂O emissions from managed soils, direct and indirect emissions, are presented in Table 5-38. In the following chapters 5.6.1 – Direct N₂O Emissions from Managed Soils and 5.6.2- Indirect N₂O Emissions from Managed Soils, further details will be developed.

Table 5-38: N₂O emissions from managed soils (kt)

Category	1990	1995	2000	2005	2010	2015	2019	2020	2021
Direct emissions	6.04	5.86	6.53	5.46	5.49	5.96	6.03	6.03	5.86
Synthetic fertilizers	2.45	2.26	2.64	1.58	1.54	1.84	1.67	1.62	1.41
Organic Fertilizers	0.96	0.90	0.89	0.73	0.67	0.64	0.73	0.76	0.76
Urine and dung deposited by grazing animals	1.81	1.97	2.31	2.52	2.70	2.79	3.02	3.04	3.06
Crop residues	0.82	0.72	0.69	0.63	0.57	0.69	0.61	0.61	0.62
Indirect emissions	1.66	1.60	1.76	1.40	1.37	1.49	1.48	1.51	1.46
Total (Direct and Indirect Emissions)	7.70	7.46	8.29	6.86	6.86	7.45	7.52	7.54	7.32

Note: Totals may not sum due to independent rounding

⁷⁶ Decree-Law nº 81/2013



5.6.1 Direct N₂O Emissions from Managed Soils

5.6.1.1 Category description

In agricultural soils, emission of N₂O is enhanced by an increase in available mineral nitrogen which promotes soil biogenic activities of nitrification and denitrification. Increase of available nitrogen in soil may be caused by anthropogenic activities such as the addition of nitrogen to soil as a fertilizer, in crop residues or as consequence of cultivation of organic soils where degradation of organic matter is enhanced liberating fixed nitrogen. Nitrous oxide emissions considered in this inventory include therefore only the increase in soil emissions that are due to human management of soils, and not comprehending the Nitrous Oxide emissions that would occur in the same area under unmanaged conditions (background emissions).

Although some scientific references indicate that soils may also be soil sinks of N₂O, there are no available sound estimate techniques and consequently these were not estimated in this inventory.

Direct emissions of N₂O resulting from the increase of nitrogen added to cultivated soils due to agricultural activities includes the following source categories:

- application of synthetic N fertilizers;
- application of organic N as fertilizer (animal manure and other organic fertilizers);
- urine and dung deposited on pasture, range and paddock by grazing animals;
- N input from incorporation of crop residues into soils.

Most effort was placed to made estimates of this source fully consistent in what concerns:

- whole time series. All activity data for each subsource was obtained from the same data source for all inventory years;
- methodology is the same applied to all inventory years;
- coherence with activity data for other source activities. Because activity data for this source is also used - or results from - emission estimates of other sources: N₂O, CH₄, NH₃ and NO₂.

Considering climate conditions, and the long period since when soils have been subjected to agriculture in Portugal, histosols are not present in Portugal and N₂O emissions from histosols may be reported as not occurring. This is also supported by FAO Harmonized World Soil Database, see map from <http://www.fao.org/soils-portal/soil-survey/soil-maps-and-databases/harmonized-world-soil-database-v12/en/>, which does not contain references to histosols in Portugal. This information is consistent with the available information of JRC:

- Map of Dominant Soil Typological Unit, no areas of histosols in Portugal
<https://esdac.jrc.ec.europa.eu/viewer/layers/geonode%3Awrblv1>,
- Map of Topsoil Organic Carbon, no areas in the High (>6% OC) class
https://esdac.jrc.ec.europa.eu/viewer/layers/geonode%3Aoc_top,
- Map of Peat, no areas containing peat
<https://esdac.jrc.ec.europa.eu/viewer/layers/geonode%3Apeat>

The comparative relevance of the several subsource activities for 2021 to direct N₂O emissions from managed soils is shown in Figure 5-31, from where it is evident the major contribution from direct deposition of urine and dung on pasture with 52.2% and synthetic fertilizers with 23.8%, which may be considered significant sources in accordance with the IPCC rule of thumb. Organic fertilizers are also an important source, representing 13.0% and crop residues source is responsible for 10.6% of the direct N₂O emissions from managed soils. The remaining 0.3% are from other organic fertilizers (sewage sludge+ compost of municipal solid waste).

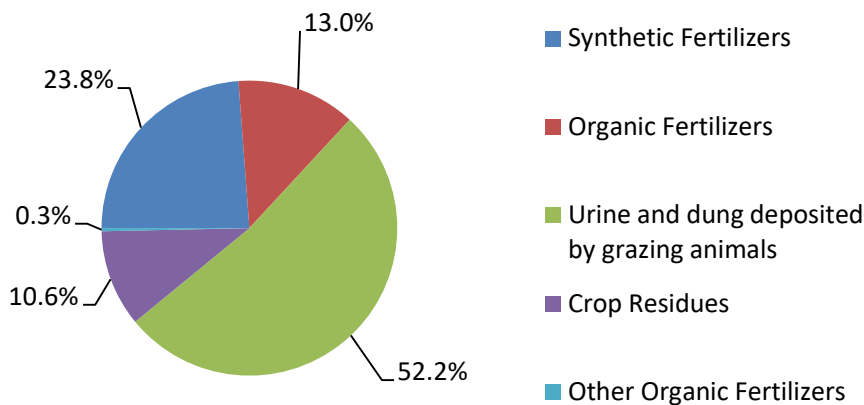

Figure 5-31: Contribution of the various subsources to direct N₂O emissions from managed soils, 2021

5.6.1.2 Methodological issues

The approach used to estimate direct N₂O emissions from managed soils follows the IPCC 2006 Tier 1 methodology with country specific activity data.

Final N₂O emissions are estimated with a formulation derived from equation 11.1⁷⁷ of IPCC 2006:

Equation 5-11: Direct N₂O emissions from managed soils

$$EN_{2O_{Direct}} = (N_{2O} - N_{N_{inputs}} + N_{2O-N_{prp}}) * 44/28$$

$$N_{2O-N_{inputs}} = (F_{SN} + F_{AM} + F_{SEW} + F_{MSW} + F_{CR}) * EF_1$$

$$N_{2O-N_{prp}} = (F_{prp, cpp} * EF_{3_{prp, cpp}}) + (F_{prp, so} * EF_{3_{prp, so}})$$

where:

$EN_{2O_{Direct}}$: total direct emission of N₂O from managed soils, kg N₂O.yr⁻¹

$N_{2O-N_{inputs}}$: annual direct N₂O-N emissions from N inputs to managed soils, kg N₂O-N.yr⁻¹

$N_{2O-N_{prp}}$: annual direct N₂O-N emissions from urine and dung deposited by grazing animals, kg N₂O-N.yr⁻¹

44/28: conversion of N₂O-N emissions to N₂O emissions

F_{SN} : annual amount of synthetic fertilizer nitrogen applied to soils, kg N.yr⁻¹

F_{AM} : annual amount of animal manure nitrogen applied to soils, kg N.yr⁻¹

F_{SEW} : annual amount of nitrogen in sludge applied to agriculture soils, kg N.yr⁻¹

F_{MSW} : annual amount of nitrogen in compost from biological treatment of municipal solid waste that is applied to agriculture soils kg N.yr⁻¹

F_{CR} : annual amount of nitrogen in crop residues returned to soils, kg N.yr⁻¹

EF_1 : emission factor for N₂O emissions from N inputs to soil, kg N₂O-N.kg N⁻¹ input

$F_{prp, cpp}$: annual amount of urine and dung N deposited by grazing cattle, poultry and Swines (cpp) on pasture, kg N.yr⁻¹

$F_{prp, so}$: annual amount of urine and dung N deposited by grazing sheep and other animals (so) on pasture, kg N.yr⁻¹

⁷⁷ Volume 4, chapter 11, page 11.7



$EF_{3\text{ prp,cpp}}$: emission factor for N_2O emissions from urine and dung N deposited by grazing animals (cpp) on pasture, $kg\ N_2O-N.kg\ N^{-1}\ input$

$EF_{3\text{ prp,so}}$: emission factor for N_2O emissions from urine and dung N deposited by grazing animals (so) on pasture, $kg\ N_2O-N.kg\ N^{-1}\ input$.

The annual amount of nitrogen in mineral soils that is mineralised (F_{SOM}) with loss of C soil from soil organic matter as a result of changes to land use (cropland remaining cropland) and the direct emissions of N_2O are reported in CRF 3D but estimates are done in LULUCF sector. Methodologies, emission factors and activity data used are described in LULUCF chapter.

5.6.1.3 Emission Factors

The emissions factors used for N_2O emissions from N_{inputs} to soil (EF_1) other than rice cultivated areas, for N_2O emissions from urine and dung N deposited by grazing animals on pasture ($EF_{3\text{ prp, cpp}}$ and $EF_{3\text{ prp,so}}$) and for flooded rice fields were the default values of IPCC 2006, table 11.1⁷⁸.

In Table 5-39 are shown the values used for EF_1 , $EF_{3\text{ prp, cpp}}$ and $EF_{3\text{ prp,so}}$.

Table 5-39: Emission factors used to estimate direct N_2O emissions from managed soils

Emission Factor	Value (Kg $N_2O-N.kg\ N\ input^{-1}$)
EF_1	0.01
$EF_{3\text{ prp, cpp}}$	0.02
$EF_{3\text{ prp,so}}$	0.01
EF_{1FR}	0.003

5.6.1.4 Activity Data

The estimated amounts of nitrogen added to agricultural soils from each specific source, which are activity data for determining direct N_2O emissions, are shown in Table 5-40 and in ANNEX C: Agriculture, for the complete time series.

Total nitrogen added to soil was in 2021 about 12.8% lower than what it was applied in 1990.

Table 5-40: Total amounts of Nitrogen (t N/yr) added to managed soils. Activity data for direct N_2O emissions

Sources	1990	1995	2000	2005	2010	2015	2019	2020	2021
Synthetic Fertilizer *	158 500	145 815	170 009	102 663	100 249	117 906	107 394	103 171	91 320
Organic Fertilizer (manure)	61 042	57 570	56 544	46 453	42 907	40 908	46 651	48 077	48 606
Pasture	70 561	76 943	88 030	92 985	97 798	98 898	107 104	107 921	108 386
Crop Residues	52 292	45 953	43 934	39 777	36 419	43 796	38 728	38 977	39 514
Organic Fertilizer (sewage & compost)	319	319	263	366	491	1 648	1 309	1 963	1 267
Total	342 714	326 601	358 780	282 244	277 864	303 156	301 186	300 110	289 092

*agriculture and forestry use

⁷⁸ Volume 4, chapter 11, page 11.11



For the last year of the inventory there are two source categories that represent the majority of nitrogen added to soil: direct droppings during grazing (37.5%) and synthetic fertilizers (31.6%) as shown in the next figure.

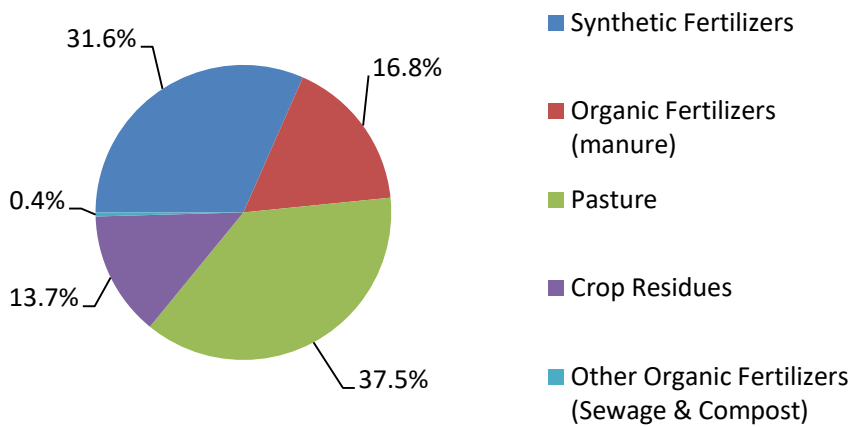

Figure 5-32: Relevance of the sources of direct input of Nitrogen to agricultural soils in 2021

5.6.1.4.1 Synthetic Fertilizers

There are no available records of statistical information concerning the annual amount of nitrogen used to agricultural soils or even available statistical information concerning sales of inorganic N fertilizers. However, following the need to answer to other communitarian and international requests, such as the calculation of Agri-environmental Indicators “Nitrogen Balance” and “Fertilizer Consumption” for the EUROSTAT and OECD, the National Statistical Institute, in collaboration with the Laboratório Químico Agrícola Rebelo da Silva⁷⁹ and ADP⁸⁰, having found the same lack of available data, produced a methodology (INE,2004) that estimates the Apparent Consumption of Fertilizers in the Agriculture activity (ACFA) by a simple mass balance, from national production⁸¹ and international market information data. The fertilizer consumption data reported by INE are obtained by the following methodology:

Equation 5-12: Annual Consumption of inorganic N fertilizers

$$\text{Consumption}_{(f)} = \text{Production}_{(f)} + \text{Import}_{(f)} - \text{Export}_{(f)}$$

where:

Consumption_(f): annual consumption in Portugal of inorganic N fertilizer f (t N.yr⁻¹)

Production_(f): annual production in industrial plants in Portugal of inorganic N fertilizer f (t N.yr⁻¹)

Import_(f): annual imports in Portugal of inorganic N fertilizer f (t N.yr⁻¹)

Export_(f): annual exports in Portugal of Nitrogen inorganic N fertilizer f (t N.yr⁻¹)

⁷⁹ Laboratório Químico Agrícola Rebelo da Silva is a public laboratory, under the Ministry of Agriculture, and proceeds to soil, plant and fertilizer analysis. Presently integrated in the National Institute for Agriculture and Veterinary Research (INIAV).

⁸⁰ ADP, Adubos de Portugal, S.A., is the main producer of fertilizers in Portugal, and responsible for about 75% of fertilizer sales (INE,2004)

⁸¹ IAPI – Annual Survey of Industrial Production made by INE to the Manufacturing Industry.



Two simplifications were made: (1) Only inorganic fertilizers were considered; (2) The effect of losses and stock variation was not accounted. According to INE (2004) these factors have no significant influence in the outcome. Another important note is that fertilizers use determined by INE includes fertilizers for agriculture and forestry use.

The ACFA time series data produced by INE are only available from 1995, not covering the inventory base year (1990). Given the fact that there is not a clear trend in the available time-series, the average amount of inorganic fertilizers in the period 1995-2002 ($158\,500\text{ t N.yr}^{-1}$) was applied for all lacking years (1990-1994).

The available time series is presented in Figure 5-33. It shows a period until 2002 with a higher consumption of inorganic fertilizers and then a sharp decrease in 2003 closely linked with the significant change, at that time, of the direct support schemes under the common agricultural policy (Council Regulation (EC) nº 1782/2003). The annual fluctuations are due to the different climatic conditions occurring each year, which may constrain production management decisions, for example carrying out the sowing of some crops.

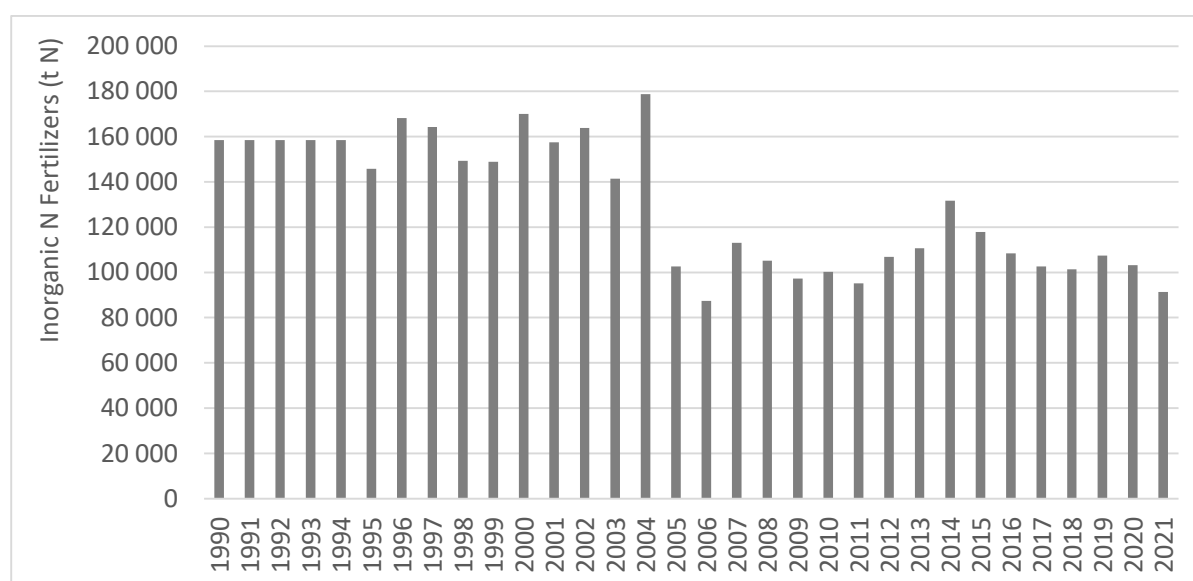

Source INE, 1995-2021; simple average value 1990-1994

Figure 5-33: Use of inorganic N fertilizers (t N.yr^{-1})

In the ANNEX C: Agriculture is also presented the annual amount of N inorganic fertilizer, disaggregated by type of N fertilizer, for the complete time series.

In Portugal, the total amount of N applied on rice fields is usually of $110\text{ to }140\text{ kg N.ha}^{-1}.\text{yr}^{-1}$ ⁸² depending on the soils. The N fertilizer application is done in two different periods as shown in Figure 5-15, chapter 5.4 of this report. The annual amount of N added on rice fields, calculated using an average of $125\text{ kg N.ha}^{-1}.\text{yr}^{-1}$, is provided in Table 5-41.

Table 5-41: Rice cultivation- Nitrogen amount applied on flooded rice fields (t N/yr)

1990	1995	2000	2005	2010	2015	2019	2020	2021
4 205	3 086	3 088	3 121	3 640	3 643	3 604	3 242	3 670

⁸² PDM 2014, ponto 2.a) Sistema de Produção do arroz em Portugal – Práticas culturais



5.6.1.4.2 Animal Manure applied to soil

The amount of managed manure nitrogen available for application to soil as fertilizer was estimated based on the equation 10.34⁸³ (IPCC 2006). In Table 5-43 are presented the final results of the estimates of the N manure from housing and storage systems that is available for application to managed soils. The use of manure for feed, fuel or construction purposes is not known in Portugal.

In the total N losses from manure management systems ($Frac_{LossMS}$) are considered the losses of N in form of NH_3 , NO_x , N_2O and N_2 that occur at housing and storage systems and the N loss through leaching from solid storage. The N input from organic bedding material (straw) was also considered for solid storage systems, based on the default values of table 3.7 of EMEP/EEA Guidebook 2019, chapter 3 B – Manure management, and are shown in Table 5-42.

Table 5-42: Average amount of straw used in animal bedding-solid manure management systems and N content of straw

Animal type	Straw (kg.hd ⁻¹ .yr ⁻¹)	N added in straw (kg.hd ⁻¹ .yr ⁻¹)
Dairy cattle	1 458.93	5.84
Other cattle	205.83	0.82
Sheep & goats	30.68	0.12
Sows	563.81	2.26
Other swine	191.97	0.77
Horses & asses	274.54	1.10

Table 5-43: Estimates of manure management nitrogen available for application to soils (t N.yr⁻¹)

Year	N in manure managed	N from bedding material	N total losses	N available to be applied to soil as manure
1990	89 615	1 612	30 185	61 042
1995	85 202	1 192	28 823	57 570
2000	85 304	808	29 567	56 544
2005	70 213	499	24 259	46 453
2010	65 419	315	22 827	42 907
2015	62 060	295	21 447	40 908
2019	72 477	301	26 127	46 651
2020	75 025	299	27 247	48 077
2021	76 041	298	27 733	48 606

5.6.1.4.3 Sewage sludge (Other organic fertilizers applied to soil)

The quantities of sewage sludge applied as soil amendment refer to data reported under the EU Directive 86/278/EEC on sewage sludge. Data for the latest years are considered to have a higher level of certainty and refer to data collected under Decree-Law n.º 276/2009 which establishes the use of sewage sludge on agricultural soils, transposing for the internal legal order the referred Directive. Data on the agriculture use of sludge under this legal provision is collected by the DRAPs (Regional Directorates for Agriculture and Fisheries), and are annually reported to the APA (Waste Department).

⁸³ Volume 4, chapter 10, page 10.65

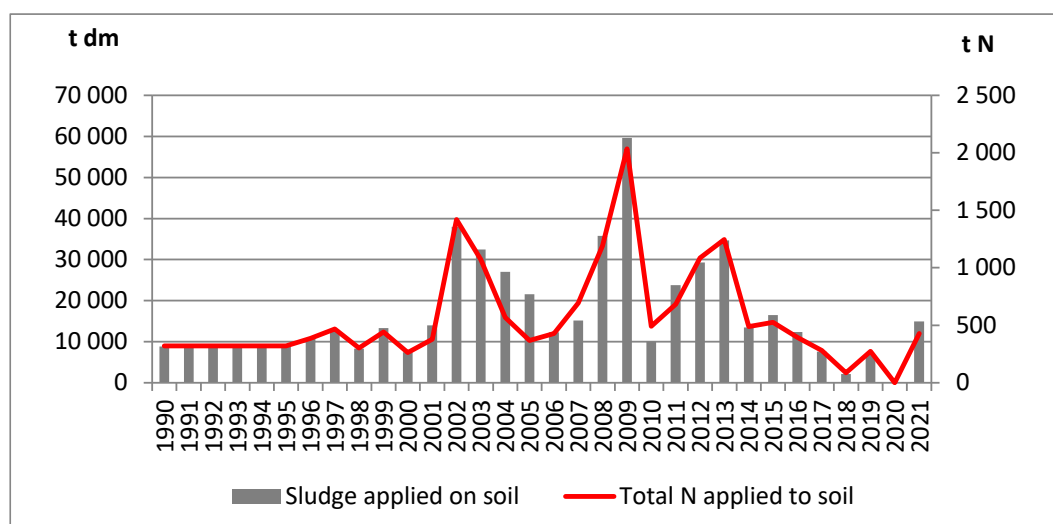

Figure 5-34: Application of sewage sludge (t dm) and quantities of N (t N) in agriculture soils

The estimated quantities of N applied in soils from sewage sludge were calculated on the basis of the data on concentrations of Total N reported.

Table 5-44: Estimates of annual amounts of nitrogen sewage sludge in agriculture soils

Year	Sewage sludge applied	N content	Total N
	(t dm)	(kg N.kg dm ⁻¹)	(t N)
1990	8 800	0.0363	319
1995	8 800	0.0363	319
2000	7 435	0.0354	263
2005	21 533	0.0170	366
2010	9 967	0.0493	491
2015	16 508	0.0318	525
2019	6 797	0.0372	273
2020	14 960	0.0431	645
2021	14 903	0.0287	427

5.6.1.4.4 Compost from municipal solid waste (Other organic fertilizers applied to soil)

The compost resulting from biological treatment of municipal solid waste (MSW) was only recognized as a fertilizer from June 2015 (Decree Law 103/2015, updated by Decree Law 9/2021). The decree establishes quality standards and control measures including the monitoring of the compost applied to agricultural soils. These provisions are now applied under Decree-Law 30/2022 (repealing Decree Law 103/2015), which establishes the rules to be followed by the placing on the market of fertilizer materials, ensuring the fulfilment of the obligations arising from the Regulation (EC) 2003/2003 and Regulation (EU) 2019/1009. Therefore, the accounting of this type of N amendment begins in 2015 and emissions from this source category are estimate from that year onwards.

In 2021 a total amount of 65928 t of MSW compost was applied to agricultural soils, which corresponds to the N amount application of 1319 t N.

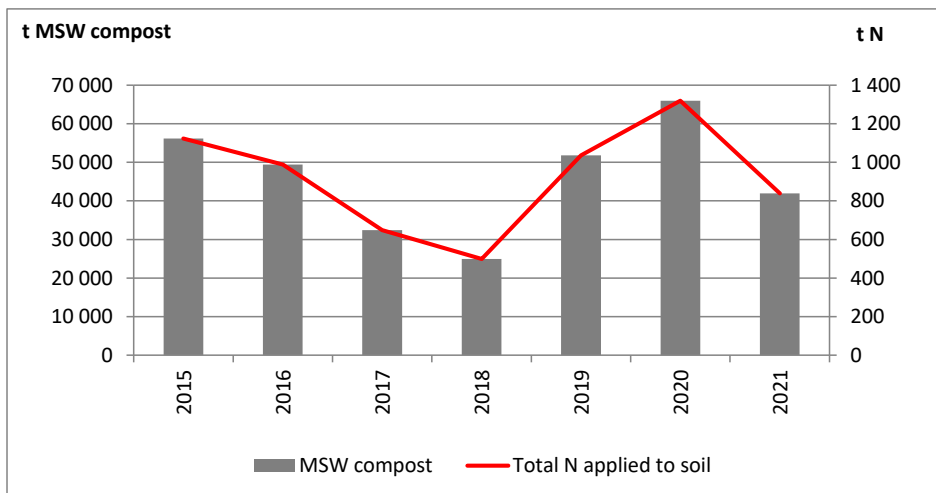

Figure 5-35: Application of Municipal Solid Waste (MSW) compost (t) and quantities of N (t N) in agriculture soils

5.6.1.4.5 Urine and dung from grazing animals

Total amount of urine and dung N deposited on pasture by grazing animals was estimated with the same N excretion rates and disaggregated livestock population that were used to estimate N₂O emissions from Manure Management (CRF 3Bb). The fraction of total annual N excretion deposited on pasture for each livestock species are presented in Table 5-23 of this report, along with the fraction of manure handled in other manure management systems considered in the Portuguese inventory.

The results of the calculation using equation 11.5⁸⁴ of IPCC 2006 are presented in Table 5-43 and in the ANNEX C: Agriculture for the complete time series.

5.6.1.4.6 Crop residues returned to soil

The annual amount of N in crop residues (above and below ground) that returned to soils was estimated according to the equation 11.7A⁸⁵ of IPCC 2006. The regression equations of table 11.2⁸⁶ of IPCC 2006 were used for the major crops.

Annual crop production (fresh) and area harvested, allowing the estimate of crop yield, was supplied by INE for the major crops.

Country specific data were used for the values of the fraction of crop that is harvested/removed from the fields ($Frac_{remove}$) and for the % of crop area with residues burnt *in situ* ($Area_{burnt}$), according to the INE information, based on data from the last Agricultural General Census (RA09) which included a set of questions about some agricultural practices. On chapter 5.7 – Field Burning of Agriculture Residues, further details are given about crop residues burnt on field.

Whenever data for $Frac_{remove}$ are not available it was assumed no removal, according to IPCC 2006 recommendation.

⁸⁴ Volume 4, chapter 11, page 11.13

⁸⁵ Volume 4, chapter 11, page 11.15

⁸⁶ Volume 4, chapter 11, page 11.17



Country specific data were also used for dry matter fraction (dm_F) of harvested crop⁸⁷ for some legumes and N content of above ground residues (N_{AG}) for cereals, potatoes and some legumes.⁸⁸ When national values are not available default values were used (table 11.2 IPCC 2006). In the same way, default values were used for the ratio of below ground residues to above ground biomass (R_{BG-BIO}) and for N content of below-ground residues (N_{BG}).

Table 5-45: Parameters used to estimate nitrogen from crop residues to soil

Crop	dm_F	Frac _{Removed}	N_{AG}	R_{BG-BIO}	N_{BG}
			(kg N.kg dm^{-1})	(ratio)	(kg N.kg dm^{-1})
Wheat	0.89	0.67 #	0.0057 #	0.24	0.009
Triticale	0.88	0.67 #	0.0085 #	0.22	0.009
Maize grain	0.87	0.65 #	0.0095 #	0.22	0.007
Barley	0.89	0.67 #	0.0045 #	0.22	0.014
Rye	0.88	0.67 #	0.0085 #	0.22	0.011
Oats	0.89	0.67 #	0.0056 #	0.25	0.008
Rice	0.89	year specific*	0.0088 #	0.16	0.009
Tobacco	0.88		0.0060	0.22	0.009
Sunflower	0.87		0.0103 #	0.22	0.009
Potatoes	0.19 #		0.0142 #	0.20	0.014
Other root crops	0.22		0.0190	0.20	0.014
Peas fresh	0.11 #		0.1818 #	0.19	0.008
Beans fresh	0.10 #		0.0190	0.19	0.008
Dry beans	0.88		0.1000	0.19	0.008
Broad beans	0.89 #		0.0337 #	0.19	0.008
Peanuts	0.94		0.0160	0.19	0.008
Other legumes	0.91		0.0080	0.19	0.008
Tomatoes	0.06 #		0.0190	0.20	0.009
Maize for forage	0.30 #	0.91 «	0.0060	0.22	0.012
Cereals for forage	0.30 #	0.91 «	0.0070	0.22	0.012
Other forage	0.90	0.91 «	0.0270	0.40	0.019

Country specific; « Jarrige (1988); * description at chapter 5.5 – rice cultivation

The annual crop yield (fresh) is presented in Table 5-46. The final amounts of Nitrogen added to soil from crop residues returned to soil are shown in Table 5-43 and in the ANNEX C: Agriculture, for the complete time series.

⁸⁷ In “Manual de Culturas Hortícolas”, Volume I e II de Domingos Almeida

⁸⁸ CBPA -Código das Boas Práticas Agrícolas. Agriculture Good Practice Code concerning the protection of waters against pollution caused by nitrates from agricultural sources, approved by the Ministry of Agriculture-

Table 5-46: Crop Yield Fresh (kg.ha⁻¹)

Crop	1990	1995	2000	2005	2010	2015	2019	2020	2021
Wheat	1 858	1 679	1 366	1 504	1 430	2 023	2 610	2 677	2 342
Triticale	1 478	1 388	1 295	1 262	1 057	1 693	1 593	1 635	1 467
Maize grain	3 083	4 375	5 793	5 293	6 929	8 452	9 805	9 345	10 105
Barley	1 430	1 464	1 345	1 675	1 514	2 097	3 156	2 729	2 526
Rye	1 020	815	965	914	859	856	1 112	1 176	1 116
Oats	911	902	1 092	1 064	1 071	1 212	1 362	1 285	1 021
Rice	4 665	5 787	5 940	5 747	5 845	6 345	5 601	4 606	6 781
Hops	1 851	1 176	1 152	1 333	1 278	2 091	1 800	1 500	2 100
Tobacco	2 235	2 606	2 795	2 955	3 343	2 262	0	0	0
Tea	664	663	2 417	3 321	2 946	4 243	4 081	2 730	3 081
Sunflower	639	313	486	473	544	1 242	1 636	1 592	1 782
Potatoes	11 671	14 644	14 831	16 000	15 034	19 771	23 586	23 371	24 595
Sugar Beet	48 901	45 007	58 009	72 990	26 082	57 610	0	0	0
Yams	9 700	9 095	15 914	16 637	16 789	20 022	17 948	16 691	16 681
Sugar Cane	75 207	80 000	80 000	86 667	85 000	51 302	56 404	55 276	52 891
Peas fresh	5 333	5 980	7 129	6 427	6 335	16 488	7 984	6 786	6 085
Beans fresh	7 781	9 472	10 013	12 741	15 344	16 979	13 151	13 416	15 657
Dry beans	524	541	512	446	582	567	668	703	701
Broad beans	0	0	0	0	0	0	0	0	0
Peanuts	1 192	1 406	2 700	1 778	2 200	2 125	2 125	2 125	2 125
Chick Peas	560	693	520	518	563	854	967	986	976
Lupins	660	955	552	407	0	0	0	0	0
Tomatoes	46 169	56 378	69 746	78 137	83 096	92 714	96 282	93 020	98 391
Maize for forage	34 005	37 978	38 363	37 750	35 517	39 022	42 709	43 870	45 052
Cereals for forage	24 568	21 224	21 818	21 942	22 162	16 032	19 000	19 078	19 534
Other forage	11 800	9 593	9 779	9 752	9 563	21 880	22 089	22 973	22 450

5.6.1.5 Uncertainty Assessment

The IPCC 2006 presents no information concerning the uncertainty in activity data, and therefore, the values were set in the following mode:

- Synthetic Fertilizers: the uncertainty value was estimated by comparison of the data (N amount in fertilizers) of apparent consumption of N fertilizers produced by INE with the consumption data of N fertilizers produced by IFA. A maximum uncertainty of 29.3% was obtained;
- For nitrogen in animal manure applied to soil the uncertainty value of 54.0% was set based in the same uncertainty values that were used for activity data in N₂O from Manure Management;
- An uncertainty error of 35.6% in crop residues production was considered in accordance with the range of errors of equation to estimate the above ground residue dry matter (table 11.2 IPCC 2006) for the most relevant crops contributing to N returned to soil;
- For urine and dung deposited on pasture by grazing animals the uncertainty value of 37.5% was set based in the same methodology used to determine uncertainty values in MMS used in the N₂O direct emissions from manure management.

The uncertainties of emission factors EF₁ for N additions from mineral, organic and crop residues and EF₃ for urine and dung deposited on pasture by grazing animals were determined from the possible range of errors of the default values. The calculated uncertainty values are: EF₁ 135.0% and EF₃ 133.2%.



5.6.2 Indirect N₂O Emissions from Managed Soils

5.6.2.1 Category description

In addition to direct N₂O emissions from managed soils, emissions of N₂O also occur through two indirect pathways: via volatilization in form of NH₃ and NO_x and via N lost from leaching and runoff.

Some of the N added to soils from synthetic and organic fertilizers and from urine and dung deposited by grazing animals is volatilized as NH₃ and NO_x. A fraction of the N volatilized returns to the ground and is then re-emitted as N₂O. In the same way, a fraction of the N added to soil, crop residues included, is lost through leaching and runoff and indirectly becomes N₂O.

Share of indirect N₂O emissions from managed soils, by pathway and by source, is shown in the next two Figures for 2021.

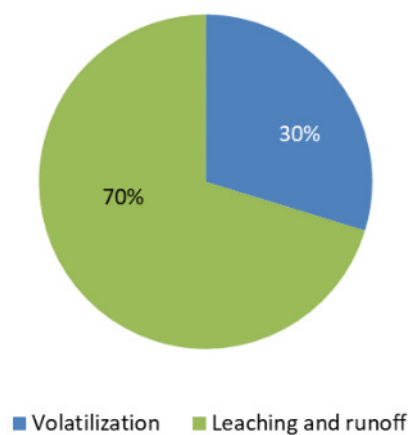

Figure 5-36: Share of indirect N₂O emissions from managed soils by pathway: volatilization and leaching/runoff, 2021

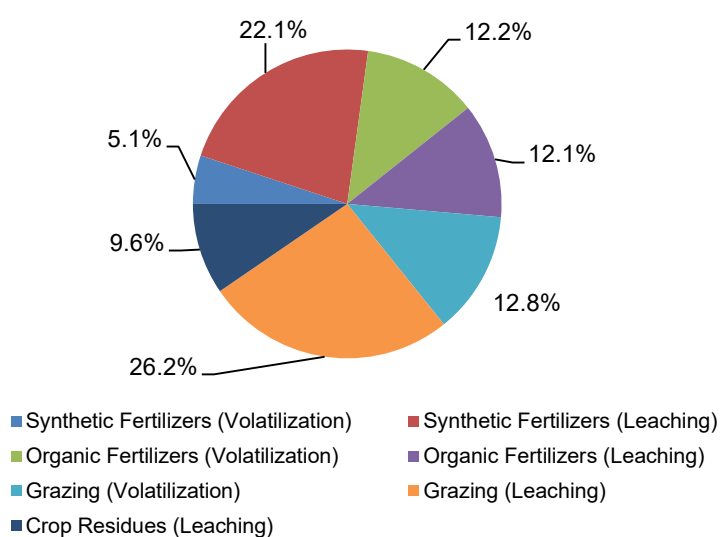

Figure 5-37: Share of indirect N₂O emissions from managed soils by source, 2021



5.6.2.2 Methodological issues

Volatilization/atmospheric deposition

Indirect N₂O emissions due to volatilization/atmospheric deposition of N added to soils were estimated based on equation 11.9⁸⁹ of IPCC 2006.

Equation 5-13: N₂O from atmospheric deposition of N volatilized from managed soils

$$N_2O_{(ATD)} = [(F_{SN} * \text{Frac}_{GASF}) + (F_{ON} + F_{PRP}) * \text{Frac}_{GASM}] * EF_4 * 44/28$$

where:

N₂O_(ATD): N₂O emissions from atmospheric deposition of N volatilized from managed soils, kg N₂O.yr⁻¹

F_{SN}: annual amount of N synthetic fertilizers applied to soils, kg N.yr⁻¹

F_{ON}: annual amount of organic fertilizers (manure + sewage sludge + compost_{MSW}) applied to soils, kg N.yr⁻¹

F_{PRP}: annual amount of N from urine and dung deposited by grazing animals on pasture, kg N.yr⁻¹

Frac_{GASF}: fraction of N from synthetic fertilizers that volatilizes as NH₃ and NO_x, kg N.yr⁻¹

Frac_{GASM}: fraction of N from organic fertilizers (manure + sewage sludge + compost_{MSW}) and from urine and dung deposited by grazing animals on pasture that volatilizes as NH₃ and NO_x, kg N.yr⁻¹

EF₄: emission factor for N₂O emissions from atmospheric deposition of N on soils, kg N₂O-N.(kg NH₃-N + NO_x-N volatilized)⁻¹

44/28: conversion of N₂O-N emissions to N₂O emissions

The collection of activity data for F_{SN}, F_{ON} and F_{PRP} is described under chapter 5.6.1 - Direct N₂O Emissions from Managed Soils.

For all source categories within managed soils, the methodologies used to estimate the annual amounts of N that volatilized in form of NH₃ and NO_x are estimated using the methodologies described, for each one, in EMEP/EEA Guidebook 2019, in consistency with UNECE/CLRTAP emissions inventory.

The amount of N from synthetic fertilizers application that volatilized as NH₃ was estimated using the tier 2 approach⁹⁰, which provides different emissions factors⁹¹ by type of fertilizer and emission region (combination of the soil pH and the climate zone as defined in IPCC 2006).

The amount of N from synthetic fertilizers application that volatilized as NO_x was estimated using a tier 1 methodology⁹² (no tier 2 available).

The amount of N from manure application and from urine and dung deposited on soil by grazing animals that volatilized as NH₃ and NO_x was estimated using the tier 2 methodology⁹³ (N_flow approach) as recommended by IPCC 2006⁹⁴.

The amount of N from sewage sludge and compost additions on soils that volatilized as NH₃ and NO_x was estimated using a tier 1 methodology⁹⁵.

⁸⁹ Volume 4, chapter, page 11.21

⁹⁰ Chapter 3D-Crop production and agricultural soils, page 14 of EMEP/EEA Guidebook 2019

⁹¹ Table 3-2 of Chapter 3D – Crop production and agricultural soils, page 15 of EMEP/EEA Guidebook 2019.

⁹² Chapter 3D – Crop production and agricultural soils, page 15 of EMEP/EEA Guidebook 2019.

⁹³ Chapter 3B – Manure management, page 20 of EMEP/EEA Guidebook 2019.

⁹⁴ Page 10.61, Emission factors for indirect N₂O emissions from manure management, chapter 10, Volume 4

⁹⁵ Chapter 3D – Crop production and agricultural soils, page 15 of EMEP/EEA Guidebook 2019.



In Table 5-47 are presented the estimated annual amounts of N, expressed in tonnes, volatilized as NH₃ and NO_x, disaggregated by source input.

Table 5-47: Annual N amounts (t) that volatilized as NH₃ and NO_x, disaggregated by source input

Year	Synthetic	Animal	Grazing	Other organic
	Fertilizers	Manure	animals	additions
1990	9 507	12 585	6 013	38
1995	8 849	12 222	6 666	38
2000	10 685	12 376	7 753	31
2005	6 447	10 430	8 422	44
2010	5 381	9 774	9 131	59
2015	7 872	9 405	9 227	150
2019	5 705	10 564	9 961	113
2020	5 414	10 857	10 043	180
2021	4 722	10 959	10 091	116

In Table 5-48 are presented the annual calculated values of Frac_{GASF} and Frac_{GASM} according to report requirements (CRF 3 D – Additional information).

Table 5-48: Frac_{GASF} and Frac_{GASM} annual values

Year	Frac _{GASF}	Frac _{GASM}
1990	0.060	0.141
1995	0.061	0.140
2000	0.063	0.139
2005	0.063	0.135
2010	0.054	0.134
2015	0.067	0.133
2019	0.053	0.133
2020	0.052	0.133
2021	0.052	0.134

The annual variation of Frac_{GASF} is mostly related with the amount and type of N synthetic fertilizers consumption in each year. In ANNEX C: Agriculture is presented, for the time series, the annual amounts of N synthetic fertilizers used by type of fertilizer.

The annual variation of Frac_{GASM} is associated with the livestock population in each year and the proportion of manure managed (housing and storage) and manure not managed (urine and dung deposited on soils). In Frac_{GASM} is also included other organic amendments to the soil.

For both cases, Frac_{GASF} and Frac_{GASM}, the calculated values are within the range of possible values, table 11.3⁹⁶ of IPCC 2006.

⁹⁶ Volume 4, chapter 11, page 11.24



Leaching and runoff

Indirect N₂O emissions from leaching and runoff originate from applied N from synthetic fertilizer (F_{SN}), organic N amendments (F_{ON}), N excreta deposited by grazing animals (F_{PRP}) and N from above and below ground crop residues (F_{CR}) were estimated based on equation 11.10⁹⁷, IPCC 2006.

Equation 5-14: N₂O emissions from leaching/runoff from managed soils

$$N_2O_{(L)} = (F_{SN} + F_{ON} + F_{PRP} + F_{CR}) * \text{Frac}_{LEACH}] * EF_5 * 44/28$$

where:

N₂O_(L): N₂O emissions produced from leaching and runoff of N additions to managed soils, kg N₂O.yr⁻¹

F_{SN}+F_{ON}+F_{PRP}+F_{CR}: defined above, kg N.yr⁻¹

Frac_{LEACH}: fraction of all N added to soils that is lost through leaching and runoff, kg N.kg N added⁻¹

EF₅: emission factor for N₂O emissions from leaching and runoff, kg N₂O- N. kg N leached and runoff⁻¹

44/28: conversion of N₂O-N emissions to N₂O emissions

The collection of activity data for F_{SN}, F_{ON}, F_{PRP} and F_{CR} is described under chapter 5.6.1 - Direct N₂O emissions from managed soils.

The value used for Frac_{LEACH} is the default value of 0.30 kg N. kg N additions⁻¹ or deposition by grazing animals proposed in table 11.3 of IPCC 2006.

N losses through runoff and leaching occurs not only during the rainy season as a result of rainfall but also during the irrigation season as a result of irrigated systems and practices. In Portugal the rainy season (October to March) is the period when the autumn/winter crops, such as wheat, barley, rye, triticale, potatoes and some legumes, are sowed and grown and the irrigation season (April to September) is the period when the spring/summer crops, such as maize, rice, tomato and other legumes, are cultivated and need to be irrigated because in normal weather conditions there is no rain during this period. Permanent crops, such as pastures, vineyards, olive groves and orchards are subjected to different agricultural practices along the two seasons. The water holding capacity of agriculture soils (where crops are grown) is exceeded as a result of both rainfall during the rainy season (autumn/winter crops) and irrigation practices associated with spring/summer crops. Hence, the same estimate of the fraction of N lost from leaching-runoff is used for the agriculture soils of the entire territory.

The national river basins⁹⁸ management plans (aggregated in eight hydrographic regions⁹⁹ in the continental territory, and one hydrographic region in each of the archipelagos of Azores and Madeira) were recently approved¹⁰⁰. They include estimates of N losses to the water bodies through runoff/leaching of the total N inputs resulting from all the agricultural activities, at the order of 17-17.5% for water surface and 12-12.4% for groundwater bodies. These means that for every unit of N applied to the soil or deposited by grazing animals, 29-29.9% is lost to the water bodies through runoff and leaching, which is very close to the default value kept for inventory calculations.

⁹⁷ Volume 4, chapter 11, page 11.21

⁹⁸ <http://snirh.pt/snirh/atlasagua/galeria/mapasweb/pt/aa1002.pdf>, continental territory;
http://servicos-sraa.azores.gov.pt/grastore/DRA/PGRHA_20162021/PGRH-A_2016-2021_RT_Parte2.pdf, archipelago of Azores;
http://www.madeira.gov.pt/Portals/12/Documentos/Ambiente/RecHidricos/PGRH/PGRH10_Parte%202%20-%20Caraterizacao%20e%20Diagnostico.pdf, archipelago of Madeira.

⁹⁹ <https://www.apambiente.pt/index.php?ref=16&subref=7&sub2ref=9&sub3ref=848>

¹⁰⁰ September 2016, continental river basins plans; December 2016, Madeira river basins plans and February 2017 Azores river basins plans.



5.6.2.3 Emission Factors

The emission factors used are shown in Table 5-49 and correspond to the default values of table 11.3 of IPCC 2006.

Table 5-49: Emission factor used for calculation of indirect N₂O emissions from managed soils

Emission Factor	Value
EF ₄	0.010 Kg N ₂ O-N.kg (NH ₃ -N+NO _x -N) ⁻¹
EF ₅	0.0075 Kg N ₂ O-N. kg N leaching/runoff ¹

5.6.2.4 Activity Data

The collection of activity data for F_{SN}, F_{ON}, F_{PRP} and F_{CR} is described under chapter 5.6.1 - Direct N₂O emissions from Managed Soils, and the annual N amounts added to soil, by source, are summarized in Table 5-43 and in the ANNEX C: Agriculture for the complete time series.

5.6.2.5 Uncertainty Assessment

Uncertainties in estimates of indirect N₂O emissions from managed soils are the result of combined uncertainties related to the fractions of N volatilized from mineral fertilizers applications (Frac_{GASF}), from organic fertilizers amendments and urine and dung deposited on pasture (Frac_{GASM}), and to the fraction of N lost by leaching/runoff (Frac_{Leach}) and the uncertainties related with the emission factors EF₄ (volatilization and re-deposition) and EF₅ (leaching and run off).

The individual uncertainty values are presented in Table 5-50.

Table 5-50: Uncertainty values (%) of the fractions of N volatilized and N leached/runoff and of the emission factors

Frac _{GASF}	Frac _{GASM}	Frac _{Leach}	EF ₄	EF ₅
135.0	112.5	116.7	135.0	163.3

5.6.3 Category specific QA/QC and verification

The QA/QC procedures applied in this source category comprehend a comparison between inventory data produced by National Statistical Authority (INE) and the databases of FAO and of IFA¹⁰¹ (<https://www.ifastat.org/databases/plant-nutrition>) for the period 2002 – 2020. For previous years (1990-2001) FAO database archive has no data registers. In both databases (FAO and IFA) 2018 is the last year available. Comparison results are shown in the next figure.

¹⁰¹ International Fertilizers Association

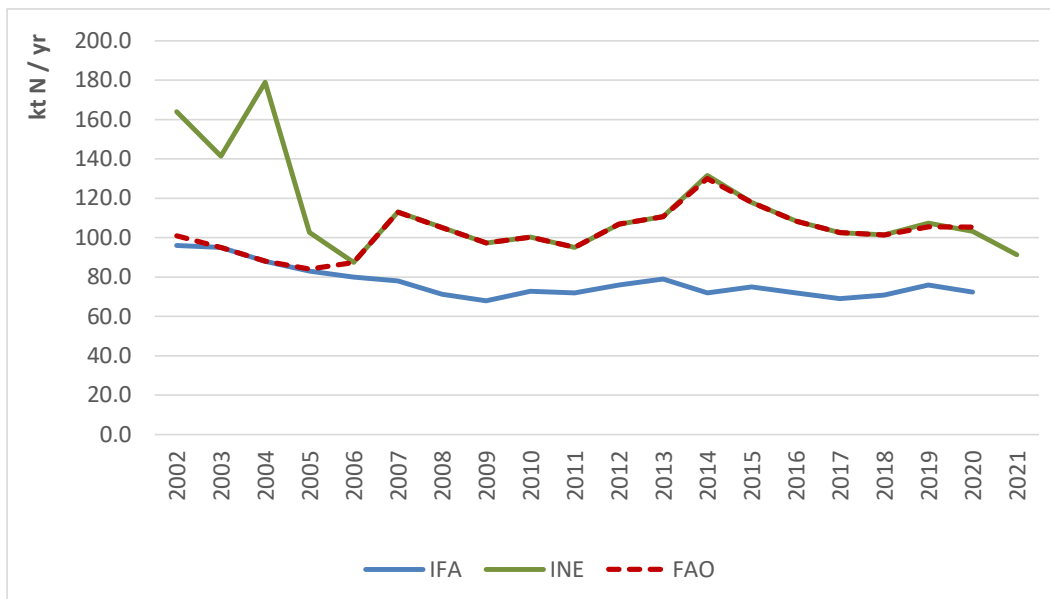

Figure 5-38: Databases comparison of inorganic N fertilizers (t N.yr⁻¹)

FAO and INE series agree quite well from 2006 onwards. IFA data are lower than INE ones because IFA consumption statistics, follow the IFA definition “relate, to the extent possible, to real consumption” and not the apparent consumption concept. The restriction access to detailed information about the construction of IFA data set prevented a further understanding of these statistics, namely how “real consumption” were produced, for instance if consumption in forestry areas is accounted. Until this issue is completely clarified we decided to keep INE statistics on apparent consumption to estimate emissions from synthetic fertilizers in a conservative approach.

Nevertheless, we underline that both series trends show a decrease in fertilizer consumption when comparing with base year, 1990.

The QA/QC procedures also included a series of checks: calculation formulas verification, data and parameters verification and the information provided in this report.

5.6.4 Category specific recalculations

The graphical representation of the differences between submissions is shown in the next figure.

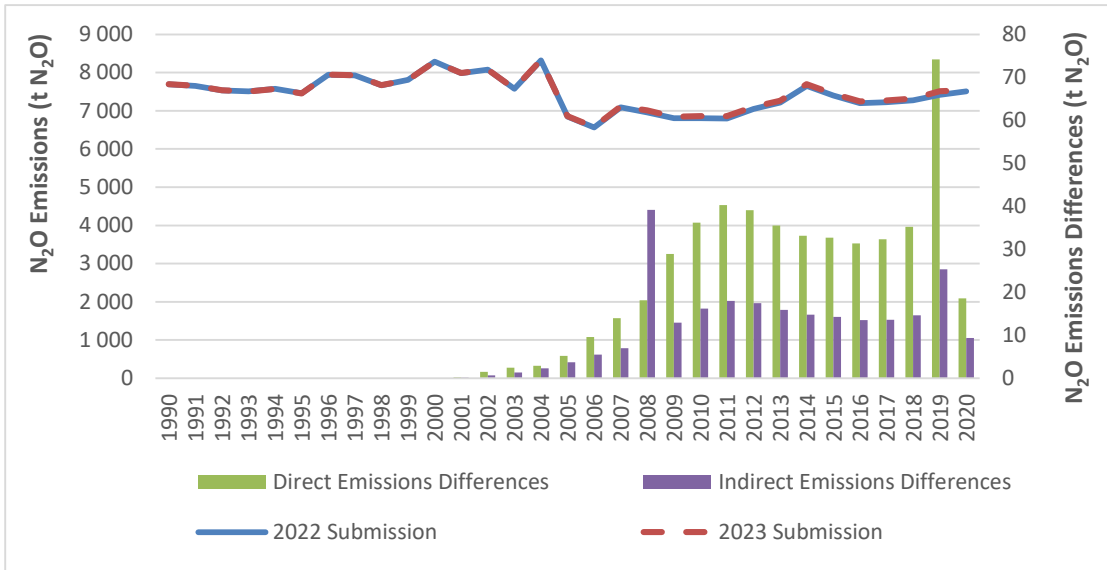

Figure 5-39: Differences between submissions (2022 and 2023) for total N₂O emissions (direct and indirect) from managed soils (t N₂O)

Differences between 2022 and 2023 submissions are mainly due to:

- the revision of National Statistics on Mules and Asses livestock numbers from 2002 onwards;

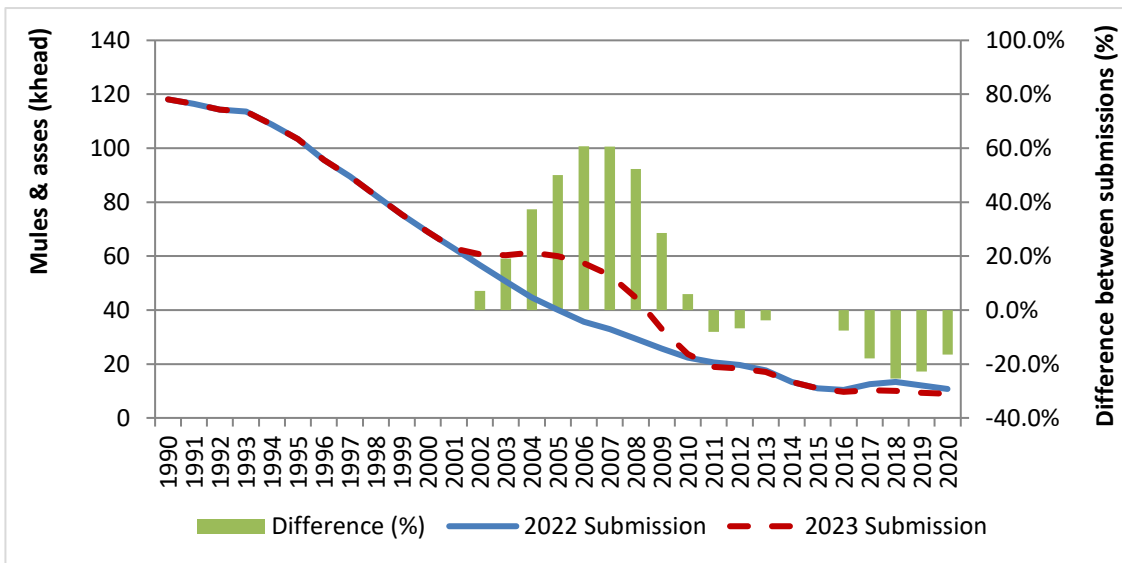

Figure 5-40: Differences in Mules & asses livestock numbers between submissions



- the revision of National Statistics on Horses livestock numbers from 2003 onwards;

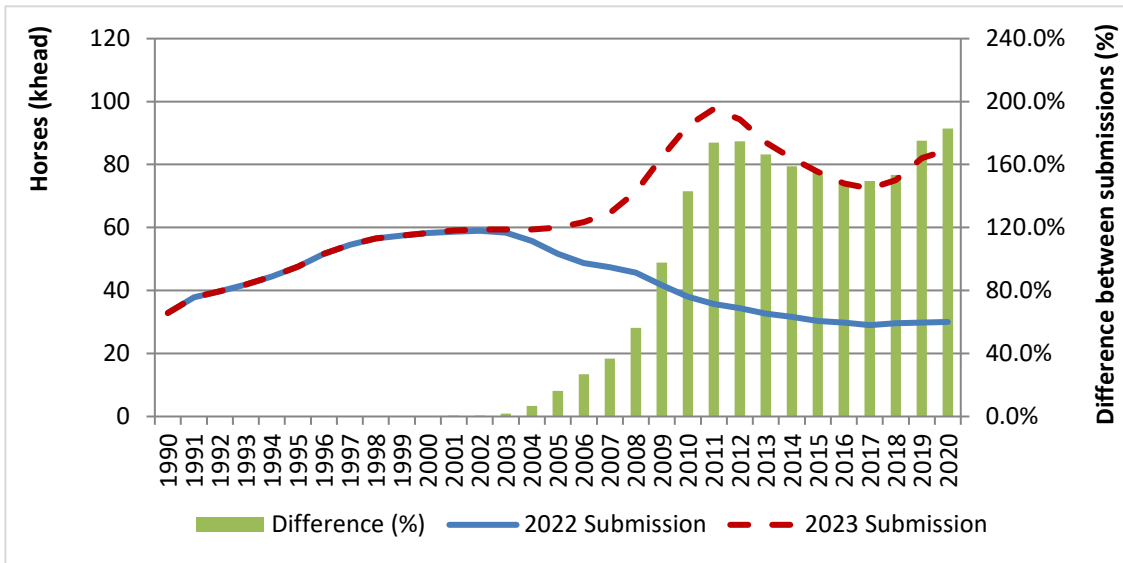

Figure 5-41: Differences in Horses livestock numbers between submissions

- the revision of National Statistics on Goats livestock numbers from 2016 onwards;

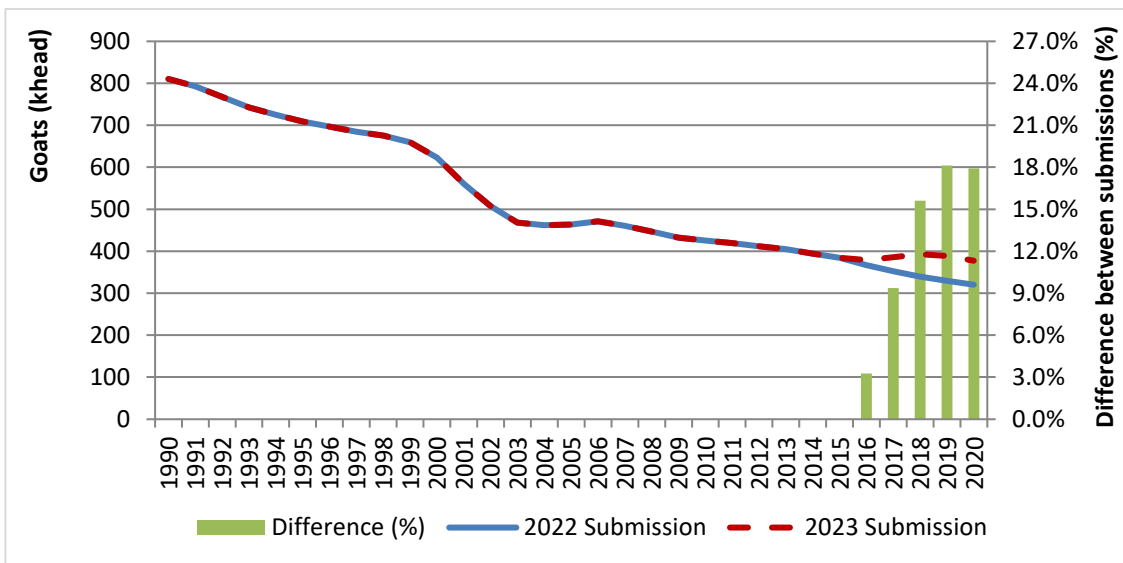

Figure 5-42: Differences in Goats livestock numbers between submissions



- the revision of National Statistics on Sheep livestock numbers from 2016 onwards;

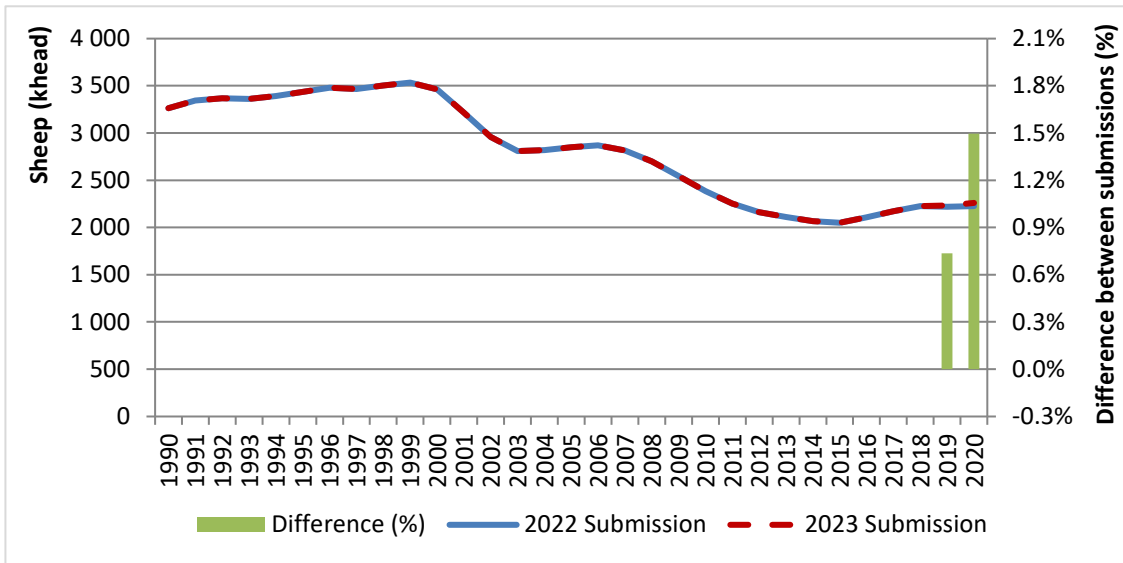

Figure 5-43: Differences in Sheep livestock numbers between submissions

- Update in Ammonium Nitrate consumption National Statistics from 2019 onwards (increase of 4499% in 2019 and a decrease of 0.5% in 2020);

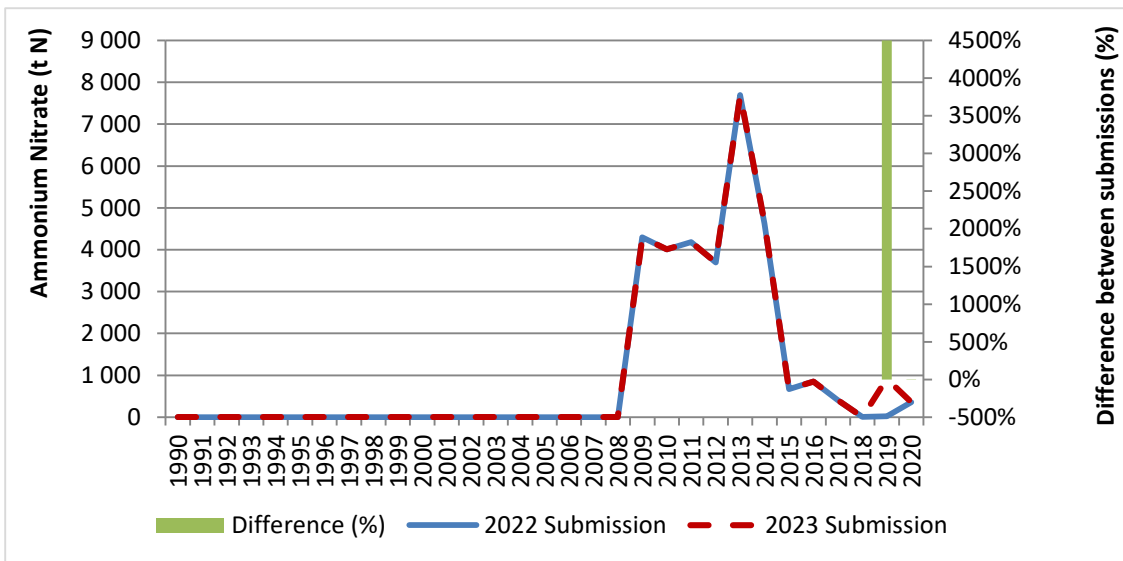

Figure 5-44: Ammonium Nitrate (AN) consumption (t N)



- Decrease of 52.9% in Ammonium Phosphate National Statistics in 2020;

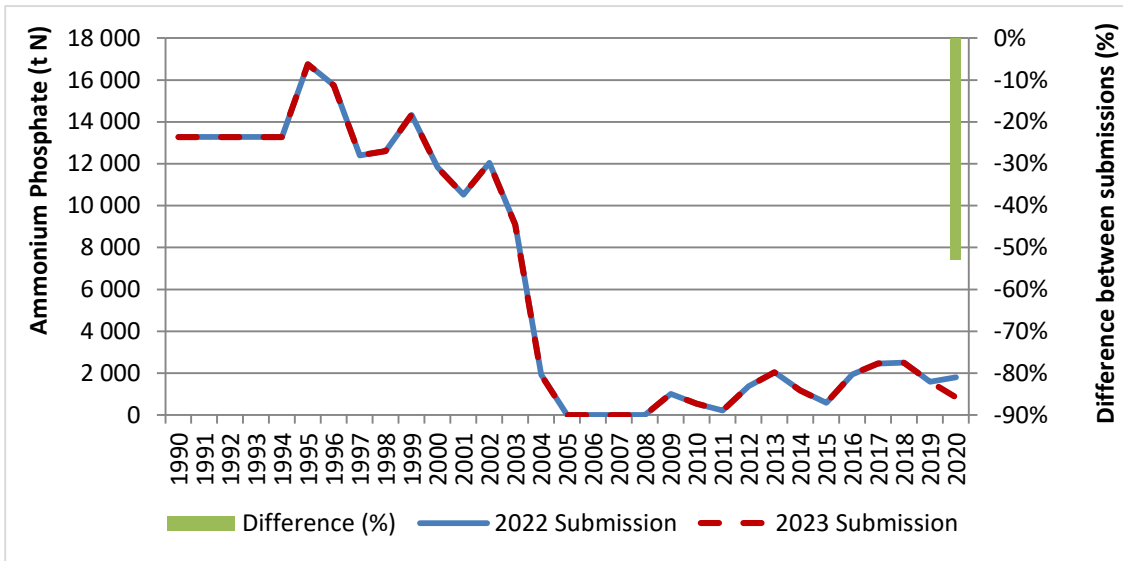

Figure 5-45: Ammonium Phosphate consumption (t N)

- Increase of 58.3% in Ammonium Sulphate National Statistics in 2020;

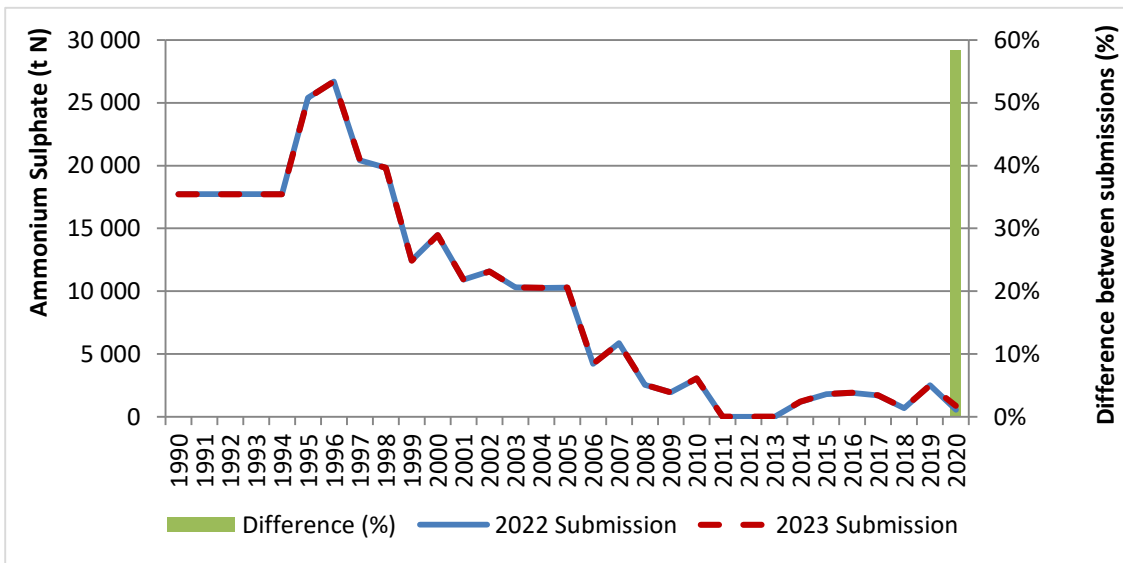

Figure 5-46: Ammonium Sulphate consumption (t N)



- Update in Calcium Ammonium Nitrate (CAN) fertilizers consumption National Statistics from 2019 onwards (an increase of 5.1% in 2019 and a decrease of 0.04% in 2020);

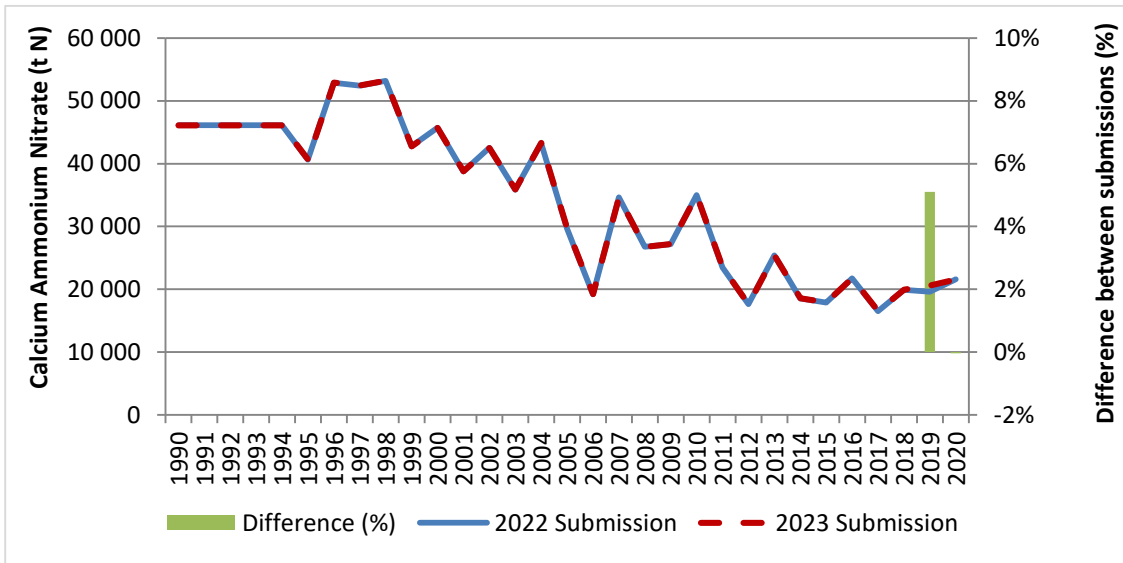

Figure 5-47: Calcium Ammonium Nitrate (CAN) consumption (t N)

- Decrease of 8.5% in Urea consumption National Statistics in 2020;

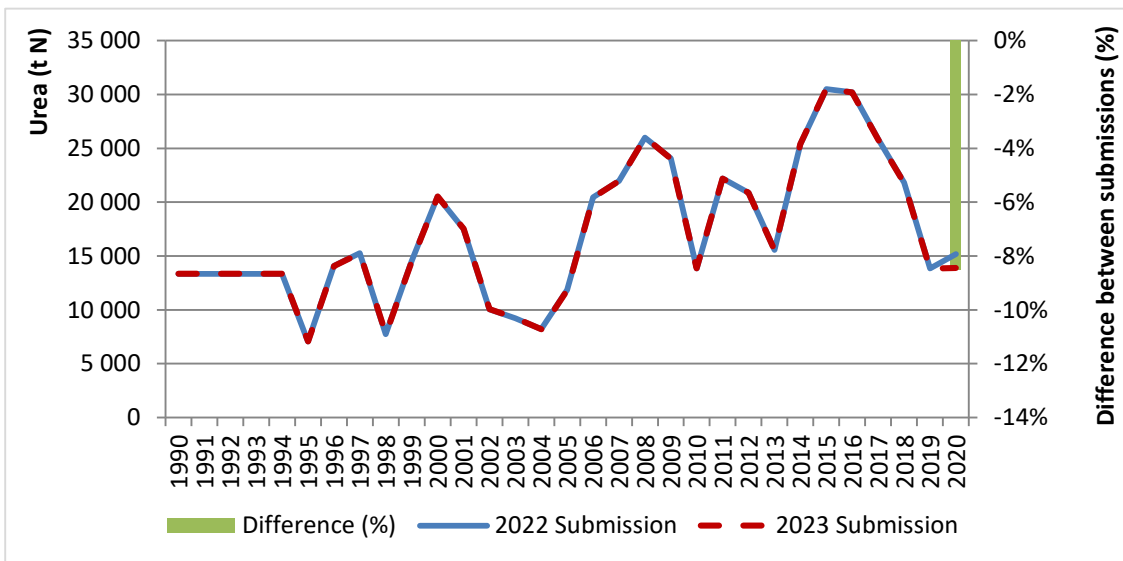

Figure 5-48: Urea consumption (t N)



- Decrease of 0.36% in “Other NP & NPK” fertilizers consumption National Statistics in 2020;

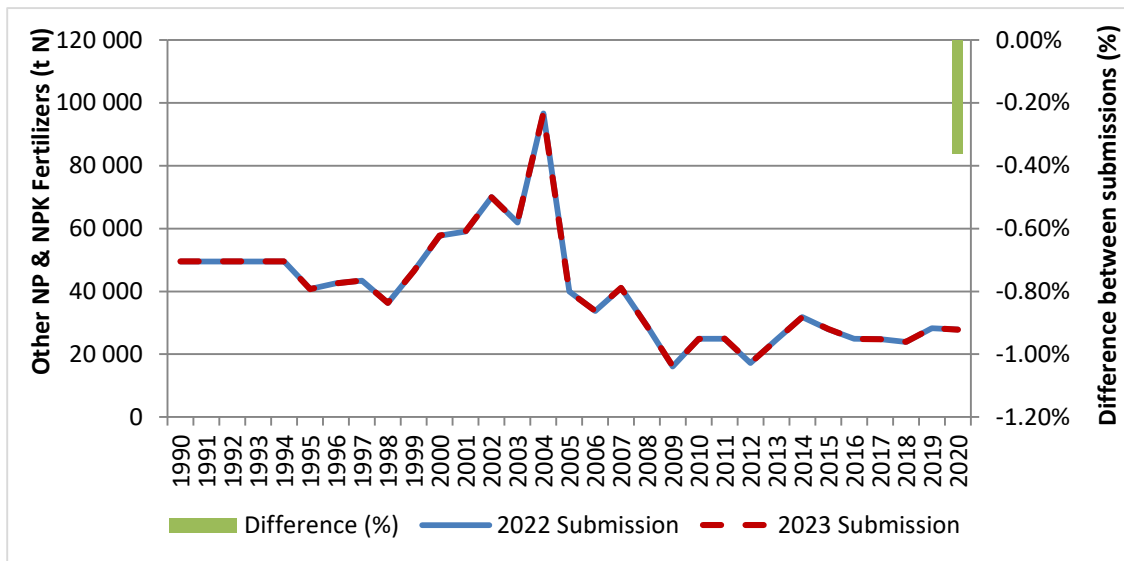

Figure 5-49: Other NP & NPK fertilizers consumption (t N)

- Decrease of 0.34% in “Other N” fertilizers consumption National Statistics in 2020.

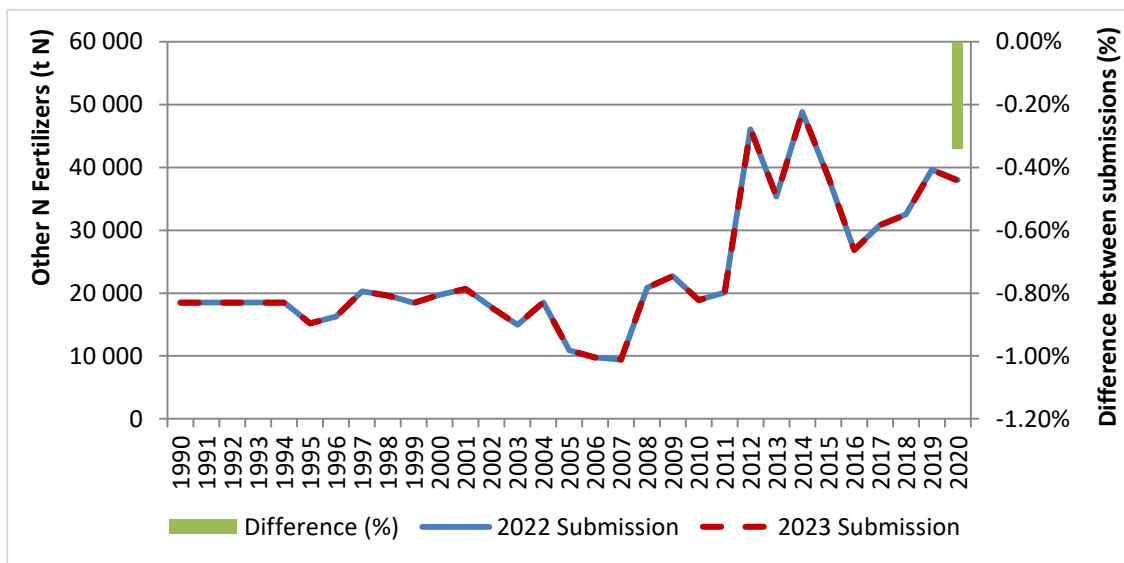

Figure 5-50: Other N fertilizers consumption (t N)

5.6.5 Category specific planned improvements

As referred in the sources categories related with manure management (CRF 3.B.a and CRF 3.B.b) it is planned to continue the improvement of the characterization of the manure management systems framed by the new national law¹⁰² related with livestock farming. Further efforts will be done to obtain more detailed information exploring new sources of information. It is likely that the possible outcome will also have impact in the N₂O emissions from manure applied to soil and from urine and dung deposited on pasture, range and paddock by grazing animals.

¹⁰² Decree-Law n^o 81/2013



5.7 Field Burning of Agriculture Residues (CRF 3.F and CRF 5.C.2)

In Table 5-51 are presented the estimates emissions from field burning of agriculture residues.

Table 5-51: CH₄ and N₂O emissions estimates from field burning of agriculture residues (kt)

Gas/Source	1990	1995	2000	2005	2010	2015	2019	2020	2021
CH₄	1.71	1.57	1.47	1.36	1.28	1.29	1.31	1.29	1.32
Wheat	0.02	0.02	0.01	0.01	0.00	0.00	0.00	0.00	0.00
Barley	0.00	0.00	0.00	0.00	0.00	0.00	0.00	0.00	0.00
Maize	0.02	0.02	0.03	0.02	0.02	0.02	0.02	0.02	0.02
Rice	0.31	0.26	0.23	0.23	0.26	0.25	0.23	0.21	0.23
Other cereals	0.01	0.01	0.01	0.00	0.00	0.00	0.00	0.00	0.00
Perennial woody crops	1.35	1.26	1.19	1.10	0.99	1.01	1.05	1.06	1.06
N₂O	0.08	0.08	0.07	0.07	0.06	0.06	0.06	0.06	0.07
Wheat	0.00	0.00	0.00	0.00	0.00	0.00	0.00	0.00	0.00
Barley	0.00	0.00	0.00	0.00	0.00	0.00	0.00	0.00	0.00
Maize	0.00	0.00	0.00	0.00	0.00	0.00	0.00	0.00	0.00
Rice	0.01	0.01	0.01	0.01	0.01	0.01	0.01	0.01	0.01
Other cereals	0.00	0.00	0.00	0.00	0.00	0.00	0.00	0.00	0.00
Perennial woody crops	0.07	0.07	0.07	0.06	0.05	0.06	0.06	0.06	0.06

Note: Totals may not sum due to independent rounding

5.7.1 Category description

In-site burning of agricultural or forest residues is still practiced nowadays in Portugal, being however restricted by the Decree-Law 82/2021, of October 13 (National System for the Defence of the Forest against Fires): is forbidden when the level of danger of rural fire is «very high» or «maximum» and, when the level of rural fire danger is below, may be authorized by the competent authorities. These burning, result in emissions of trace gases as in other combustion processes, including methane, nitrous oxide, carbon monoxide and volatile organic compounds. Carbon dioxide is of course also emitted in this process, but because it has biomass origin and it is in principle re-absorbed during next growing season, it is not considered in GHG emissions inventory.

The burning of agricultural residues occurs with the straw of cereals and with the material of pruning permanent crops such as vineyards, olive groves and other orchards. Considering equivalent carbon dioxide emissions (Figure 5-51), burning of residues from vineyards is the most significant source of this non-key source.

Emissions from field burning of agriculture residues of cereals are reported in CRF 3F.

Emissions from field burning of agriculture residues of perennial crops (orchards, vineyards and olive groves) are reported in CRF 5C2.

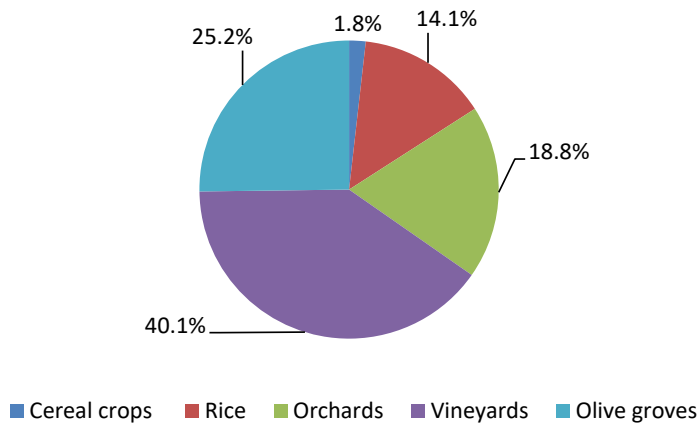

Figure 5-51: Share of GHG emissions from field burning agriculture residues, by crop, 2021

5.7.2 Methodological issues

Emissions of in-site burning of agriculture residues were estimated based on equation 2.27¹⁰³ from the IPCC 2006 which is summarized in the following equation:

Equation 5-15: Estimation of GHG emissions from field burning of crop residues

$$\text{Emission}_{(p,crop)} = A_{(crop)} * M_{B(crop)} * C_f * EF_{(p,crop)} * 10^{-3}$$

where:

$Emission_{(p,crop)}$: emission estimates of pollutant p from field burning of residues from a specific crop, $t.yr^{-1}$

$A_{(crop)}$: correspond to the crop area where the practice of field burning residues occurs, $ha.yr^{-1}$

C_f : combustion factor, dimensionless

$M_{B(crop)}$: biomass of a specific crop that is available for combustion, $t\ dm.ha^{-1}.yr^{-1}$

$EF_{(p,crop)}$: emission factor from field burning of agriculture residues of a specific crop, $g.kg\ dm\ burnt^{-1}$

5.7.3 Emission Factors

The emission factors used to estimate, CH_4 , N_2O , CO , $NMVOC$ and NO_x emissions from field burning agriculture residues are the default values from IPCC 2006 (table 2.5¹⁰⁴) and from EMEP/EEA Guidebook 2019 (chapter 3F). They are presented in Table 5-52 with source indication by crop and pollutant.

¹⁰³ Volume 4, chapter 2, pg 2.42

¹⁰⁴ Volume 4, chapter 2, page 2.47

**Table 5-52: Emission factors for field burning agriculture residues, g. kg dm burnt⁻¹**

Crop	CH ₄	N ₂ O	NO _x	NMVOC	CO
Wheat	2.7"	0.07"	2.3*	0.5*	66.7*
Barley	2.7"	0.07"	2.7*	11.7*	98.7*
Maize	2.7"	0.07"	1.8*	4.5*	38.8*
Rice	2.7"	0.07"	2.4*	6.3*	58.9*
Other cereals	2.7"	0.07"	2.3#	0.5#	66.7#
Orchards	4.7"	0.26"	3.0"	0.7»	107.0"
Vineyards	4.7"	0.26"	3.0"	0.6»	107.0"
Olive grove	4.7"	0.26"	3.0"	1.4»	107.0"

"Table 2.5 of IPCC guidelines 2006; #Table 3-1 of EMEP/EEA guidebook 2019; chapter 3F; * Wheat, barley, maize and rice values from tables 3-3, 3-4, 3-5 and 3-6 of EMEP/EEA guidebook 2019; chapter 3F; » Table 2.5-5 AP_42 USEPA

5.7.4 Activity Data

For cereals, other than rice, the practice of straw burning occurs in about 1% of the cultivated area according to the INE information based on General Agricultural Census (RA09) which included a set of questions about some agricultural practice.

In chapter 5.4 - CH₄ Emissions from Rice Cultivation (CRF 3.C), has already been described the relevant rice cultivation practices in Portugal, including the burning of rice residues on field. The major fraction of rice stubbles and straw are burnt on fields except in the rice producing areas inside Natura 2000 where that practice is forbidden for reasons of conservation of natural habitats and animal species. The evolution of rice cultivation areas where the practice of burning residues is not allowed is shown in Figure 5-20 in chapter 5.4 - CH₄ Emissions from Rice Cultivation (CRF 3.C).

Each year the orchards, vineyards and olive groves are pruned and much of the resulting material of this action is burned in situ. This practice occurs in 22% of the orchards area, 52% of the vineyard areas and 65% of olive grove areas, according to the information collected in the General Agricultural Census (RA09).

The amount of biomass available for combustion for cereal crops (rice included) was estimated based on the same methodology used to estimate crop residues production, i.e., the regression equations in table 11.2¹⁰⁵ of IPCC 2006, in consistence with calculations to estimate the amount of crop residues that returned to soil dealt on the chapter 5.6 - N₂O Emissions from Managed Soils (CRF 3.D) of this report.

The amounts of pruning material produced for each of the permanent crops are country specific¹⁰⁶ values presented in Table 5-53.

¹⁰⁵ Volume 4. chapter 11, page 11.17

¹⁰⁶ Dias, J.J. Mestre (2002), "Utilização da biomassa: avaliação dos resíduos e utilização de pellets em caldeiras domésticas".



Activity data and parameters used to estimate emissions from cereal and permanent crops residues burnt on field are summarized in Table 5-53 for 2021. Combustion factors used for cereals are the default values from Table 2.6 of IPCC 2006¹⁰⁷. For pruning material from permanent crops, the combustion factor considered was made equal to 1, following the recommendation of the EMEP/EEA Guidebook 2019¹⁰⁸.

Table 5-53: Activity data and parameters used to estimate emissions from field burning of crop residues, 2021

Crop	Biomass available		Combustion factor
	Area burnt* (kha)	for combustion (t dm.ha ⁻¹)	
Wheat	0.29	3.67	0.9
Barley	0.19	2.79	0.9
Maize	1.04	9.66	0.8
Rice	12.74	8.19	0.8
Other cereals	0.65	1.89	0.9
Orchards	29.84	1.69	1.00
Vineyards	90.43	1.19	1.0
Olive grove	247.27	0.27	1.0

*Area where the on field burning practice of crop residues occurs

In the next Figure is shown the annual biomass burnt from 1990 onwards.

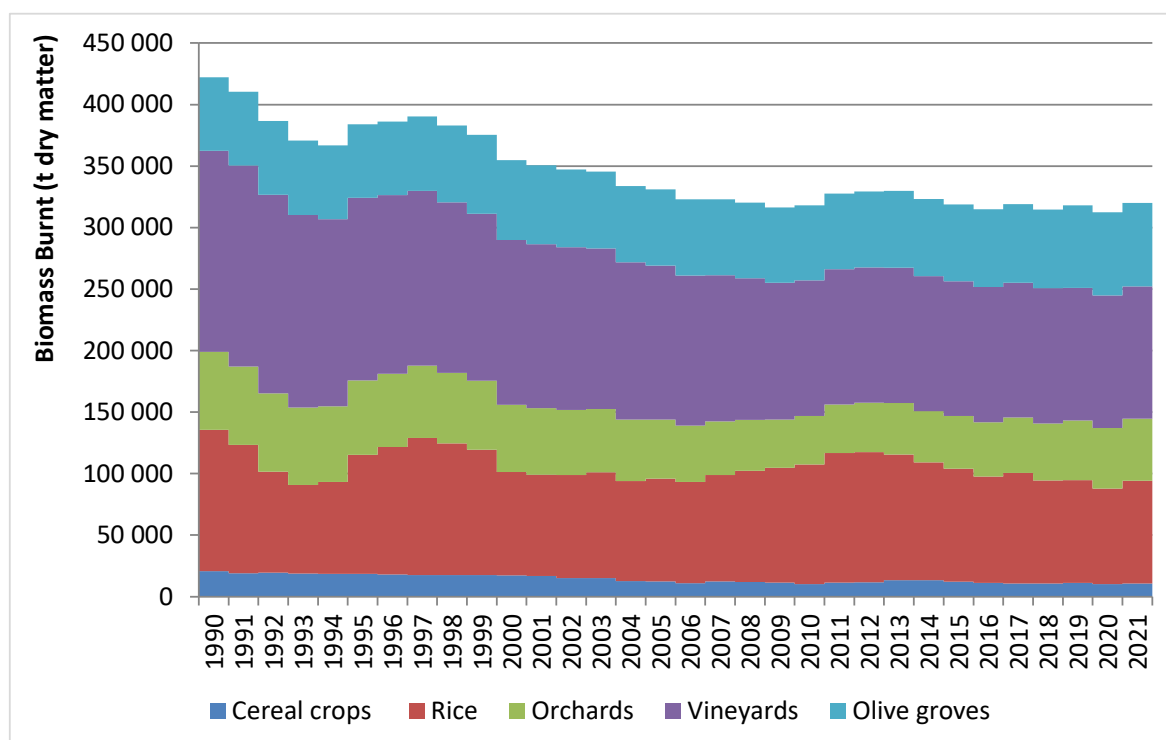

Figure 5-52: Annual biomass burnt (t dm .yr⁻¹) for the time series

¹⁰⁷ Volume 4, chapter 2, page 2.49

¹⁰⁸ Chapter 3F, page 6



5.7.5 Uncertainty Assessment

The uncertainty in activity data was obtained from the combined uncertainties related with the areas where on field burning practice occurs and with the crop biomass available for combustion. The individual uncertainties and the final value for activity data uncertainty is presented in Table 5-54.

Table 5-54: Uncertainty values (in %) of the activity data for on field burning crop residues

Crop	Area burnt	Biomass available	Activity Data
Cereals	25.0	35.6	43.5
Perennial Woody crops*	25.0	25.0	35.4

*Pruning material

The uncertainty of the emission factors were calculated considering the uncertainties ranges in IPCC 2006, and are presented in Table 5-55.

Table 5-55: Uncertainty values (in %) of the emission factors, CH₄ and N₂O, for on field burning crop residues

Crop	EF CH ₄	EF N ₂ O
Cereals	39.1	47.6
Perennial Woody crops*	40.4	26.9

5.7.6 Category specific QA/QC and verification

QA/QC procedures included a series of checks: calculation formulas verification, data and parameters verification, and the information provided in this report.

5.7.7 Category specific recalculations

Recalculations were made from 2000 onwards, based on national statistics updates on Biomass Burnt.

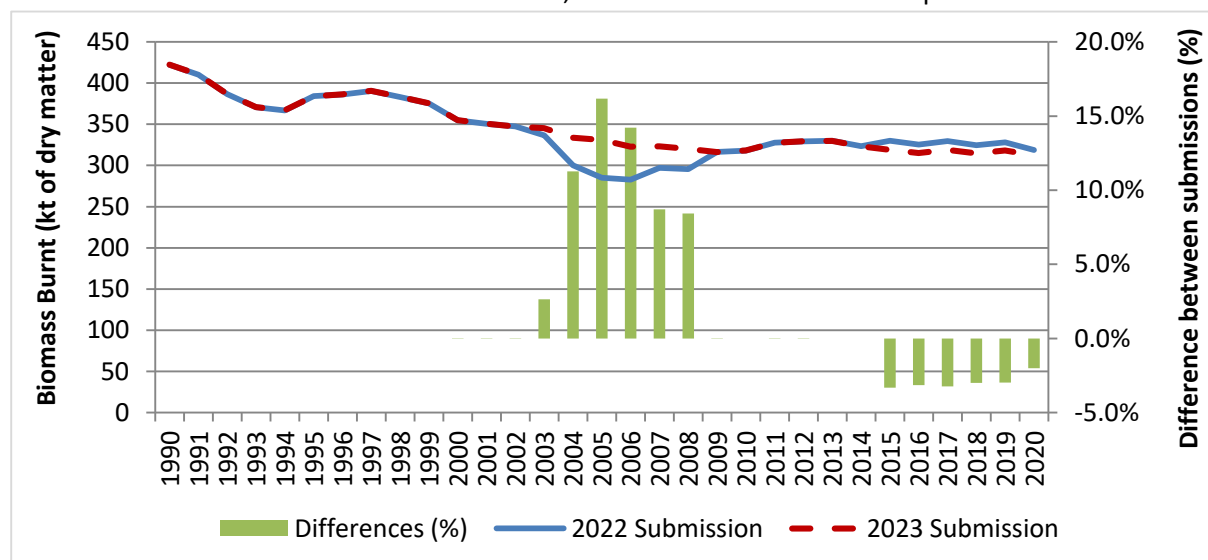

Figure 5-53: Amount of biomass burnt (kt dm). Differences between 2022 and 2023 submissions

5.7.8 Category specific planned improvements

No specific improvements are planned.



5.8 CO₂ Emissions from Liming (CRF 3.G)

5.8.1 Category description

Liming of soils in agricultural and forest land is considered a minor practice in Portugal and information on the application of lime in soils is scarce. Prior to the 2015 submission, emissions from lime and dolomite were reported under LULUCF chapter.

In 2021, emissions from liming were estimated in 9.2 kt CO₂, corresponding to an increase of 41.0% compared to 1990 emissions (6.5 kt CO₂).

5.8.2 Methodological issues

Emissions associated with liming were estimated using a Tier 1 method (equation 11.12¹⁰⁹, IPCC 2006).

5.8.3 Emission Factors

It was used the default emission factors for carbon conversion of 0.12 for limestone (CaCO₃), 0.13 for dolomite (MgCO₃) and 0.143 for CaMg(CO₃)₂, which are equivalent to carbonate carbon contents of the materials (12% for CaCO₃, 13% for MgCO₃ and 14.3% for CaMg(CO₃)₂).

5.8.4 Activity Data

The amount of carbonate containing lime applied annually to soils in the country was estimated on the basis of the information collected directly from the national producing limestone and dolomite for agricultural use. It was obtained information on carbonate containing lime production, imports and exports and also on the constitution of each carbonate containing lime applied to soils in Portugal.

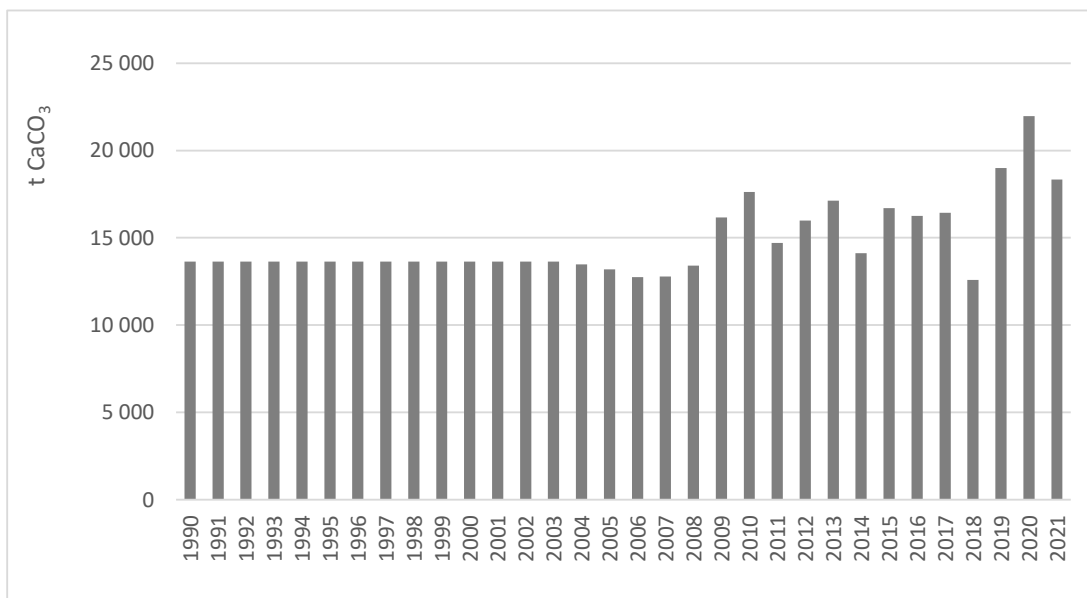

Figure 5-54: CaCO₃ used on agriculture land (t.yr⁻¹)

¹⁰⁹ Volume 4, chapter 11, page 11.27

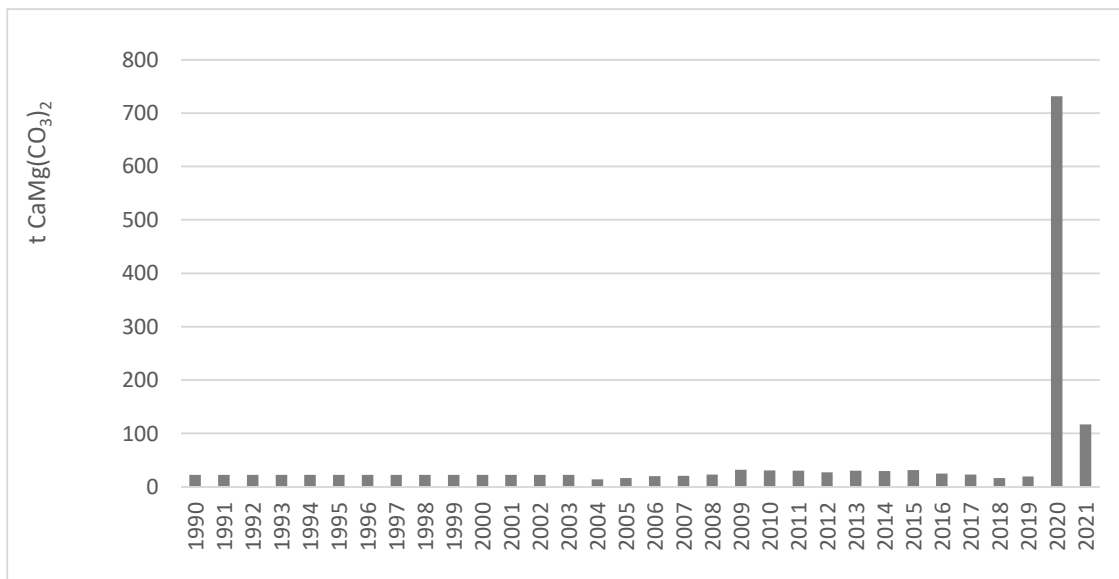

Figure 5-55: CaMg(CO₃)₂ used on agriculture land (t.yr⁻¹)

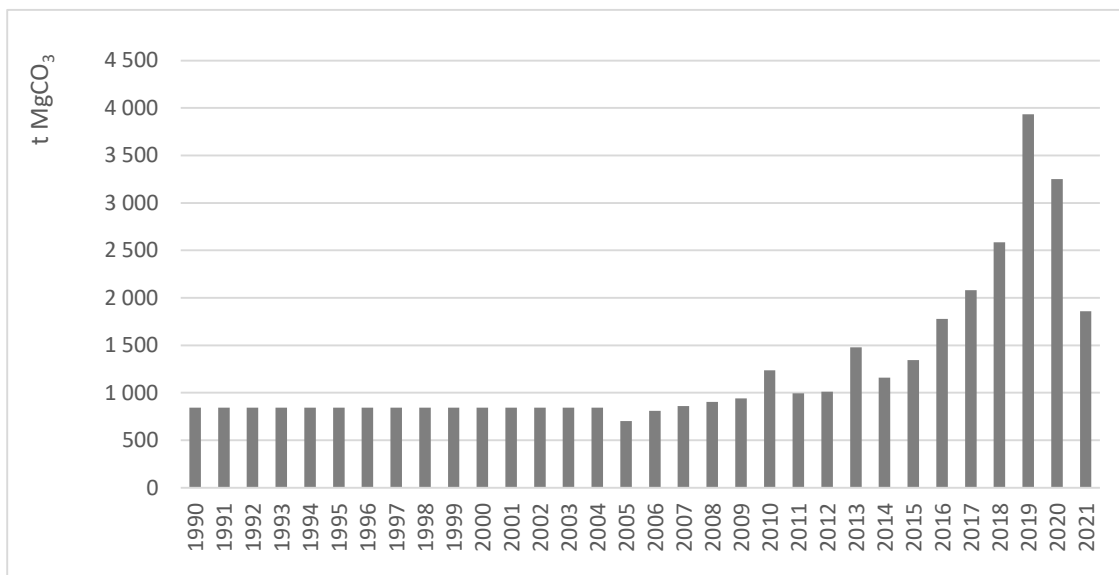

Figure 5-56: MgCO₃ used on agriculture land (t.yr⁻¹)

5.8.5 Uncertainty Assessment

Under the IPCC 2006 Tier 1 methodology, the default emission factor was used, which assume conservatively that all carbon from liming is emitted as CO₂ into the atmosphere. The default emission factor represents the absolute maximum emissions associated with liming added to soils so is assumed certain.

Activity data uncertainty was considered of 50 %.

5.8.6 Category specific QA/QC and verification

QA/QC procedures included the verification of calculation formulas and the consistency with previous submission estimates.



5.8.7 Category specific recalculations

This sector activity data has been revised.

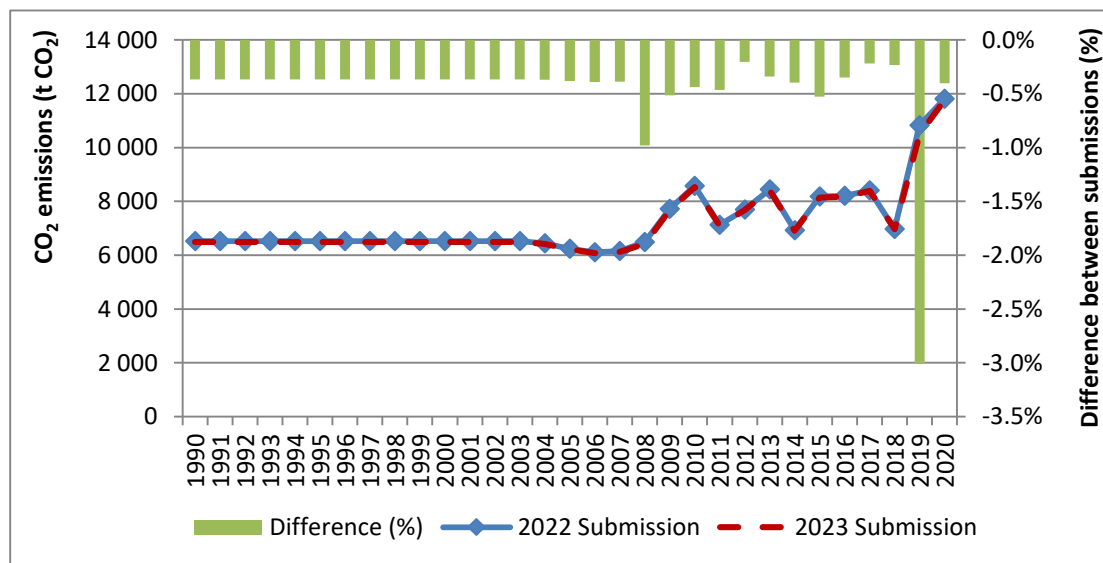

Figure 5-57: CO₂ emissions differences between 2022 and 2023 submissions (%)

5.8.8 Category specific planned improvements

No specific improvements are planned.

5.9 CO₂ Emissions from Urea application (CRF 3.H)

5.9.1 Category description

Urea fertilizer is one of the N fertilizers types used in Portugal and in 2021 it accounts about 11.2% of the N synthetic fertilizers applications to the soil, 1.3 times more than in 1990 (8,4%).

CO₂ emissions from urea application produced 16.3 kt CO₂ in 2021. This represents a decrease of 23.5% compared to 1990 CO₂ emissions from urea applied to agricultural soils.

5.9.2 Methodological issues

Emissions associated with urea application were estimated using a Tier 1 method (equation 11.13¹¹⁰, IPCC 2006).

5.9.3 Emission Factors

It was used the default emission factor for carbon conversion of 0.20 which is equivalent to carbonate carbon contents of urea in an atomic basis.

¹¹⁰ Volume,4, chapter 11, page 11.32



5.9.4 Activity Data

Data on nitrogen fertilizers consumption, urea included, are provided by INE and are obtained as it was explained in chapter 5.5.1.4.1 - Synthetic Fertilizers (activity data). The total amount of urea fertilizer use is shown in the next Figure.

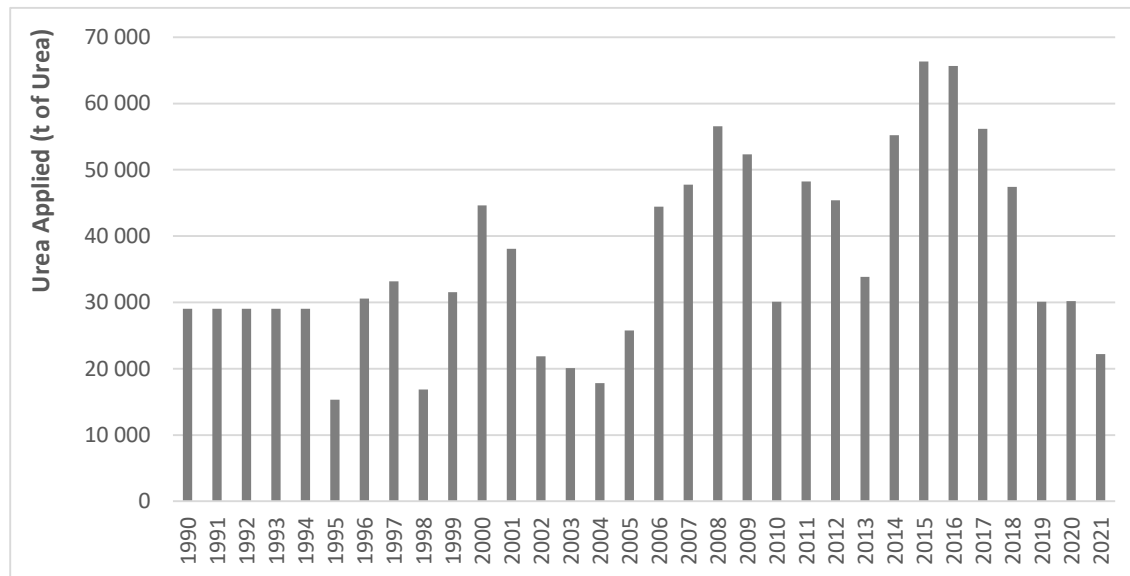

Figure 5-58: Urea fertilizer application on agriculture land (t. yr⁻¹)

5.9.5 Uncertainty Assessment

Under the IPCC 2006 Tier 1 methodology, the default emission factor was used, which assume conservatively that all carbon in the urea is emitted as CO₂ into the atmosphere. The default emission factor represents the absolute maximum emissions associated with urea fertilization so is assumed certain.

The uncertainty of activity data, apparent consumption of urea, was assumed the same that was considered for N synthetic fertilizers in direct N₂O emissions from managed soils, i.e., 29.3%.

5.9.6 Category specific QA/QC and verification

QA/QC procedures included a series of checks: calculation formulas verification, data collection verification and the information provided in this report.

5.9.7 Category specific recalculations

Changes between last year submission and this year submission result from the update of Urea application statistics (decrease of 8.5%) by the National Statistics Authority (INE).

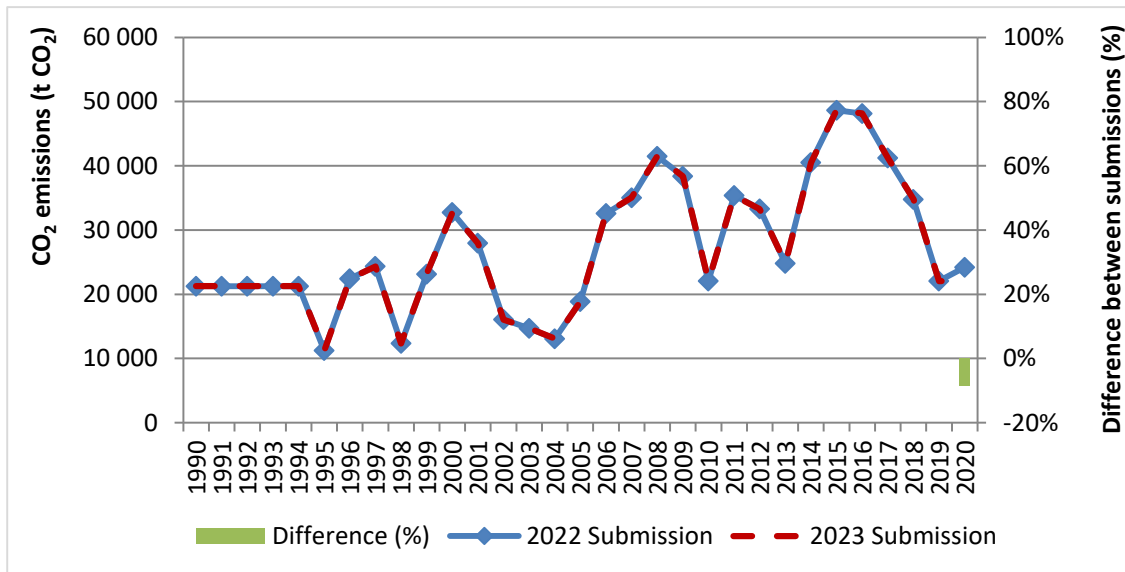

Figure 5-59: CO₂ emissions differences between 2022 and 2023 submissions (%)

5.9.8 Category specific planned improvements

No specific improvements are planned.

5.10 CO₂ Emissions from Other Carbon-containing fertilizers (CRF 3.I)

5.10.1 Category description

To ensure the completeness of the agricultural inventory, CO₂ emissions from Calcium Ammonia Nitrate (CAN) fertilizer are reported under the category 3.I Other carbon containing fertilizers.

In 2021, the CO₂ emissions from CAN application were estimated in 5.61 kt CO₂, corresponding to a decrease of 72.9% compared to 1990 emissions (20.68 kt CO₂).

5.10.2 Methodological issues

Emissions associated with CAN fertilizer use were estimated using a Tier 1 method (equation 11.12¹¹¹, IPCC 2006) because CAN in Portugal contains limestone.

The CAN fertilizer used in Portugal, according to the information provided by the National Statistics Authority, INE, are the so called “Nitrolusal”, a mixture of ammonium nitrate (NH₄NO₃) and limestone (Ca CO₃). There are two types of “Nitrolusal” fertilizers with different CaCO₃ contents. The most used (84%), Nitrolusal 27N has an estimated CaCO₃ fraction of about 23%, and the Nitrolusal 20.5N, whose consumption is around 16% on average, has an estimated CaCO₃ fraction of about 41%.

¹¹¹ Volume 4, chapter 11, page 11.27



- Step 1 -

$$N \text{ in Nitrolusal}_{27N} = N \text{ in CAN}_{\text{fertilizer}} \times \% \text{Nitrolusal}_{27N}$$

Where:

- N in Nitrolusal_{27N} - Amount of N used in fertilizer with 27% N in its constitution (kg of N)
- N in CAN_{fertilizer} - Amount of N used both in fertilizers with 27% N and 20.5% N (kg of N)
- %Nitrolusal_{27N} - Average % of CAN fertilizer sold with 27 % N (%) - it was assumed 84%

$$N \text{ in Nitrolusal}_{20.5N} = \text{CAN}_{\text{fertilizer}} \times \% \text{Nitrolusal}_{20.5N}$$

Where:

- N in Nitrolusal_{20.5N} - Amount of N used in fertilizer with 20.5% N in its constitution (kg of N)
- N in CAN_{fertilizer} - Amount of N used both in fertilizers with 27% N and 20.5% N (kg of N)
- %Nitrolusal_{20.5N} - Average % of CAN fertilizer sold with 20.5 % N (%) – it was assumed 16%

- Step 2 -

$$\text{Nitrolusal}_{27N} = \frac{N \text{ in Nitrolusal}_{27N}}{0.27}$$

Where:

- Nitrolusal_{27N} - Amount of fertilizer used with 27% N in its constitution (kg of Nitrolusal_{27N} fertilizer)
- N in Nitrolusal_{27N} - Amount of N in fertilizer used with 27% N in its constitution (kg of N)

$$\text{Nitrolusal}_{20.5N} = \frac{N \text{ in Nitrolusal}_{20.5N}}{0.205}$$

Where:

- Nitrolusal_{20.5N} - Amount of fertilizer used with 20.5% N in its constitution (kg of Nitrolusal_{20.5N} fertilizer)
- N in Nitrolusal_{20.5N} - Amount of N in fertilizer used with 20.5% N in its constitution (kg of N)

- Step 3 -

$$\text{CaCO}_3 \text{ in Nitrolusal}_{27N} = \text{Nitrolusal}_{27N} \times \left[100\% - \left(\% \text{N}_2 \text{ in Nitrolusal}_{27N} \times \frac{M(\text{NH}_4\text{NO}_3)}{M(\text{N}_2)} \right) \right]$$

Where:

- CaCO₃ in Nitrolusal_{27N} - Amount of CaCO₃ in fertilizer used with 27% N in its constitution (kg of CaCO₃)
- Nitrolusal_{27N} - Amount of fertilizer used with 27% N in its constitution (kg of Nitrolusal_{27N} fertilizer)
- %N₂ in Nitrolusal_{27N} - % of N₂ in the fertilizer used with 27% N in its constitution (% mass/mass) = 27%
- M(NH₄NO₃) - Molar Mass of NH₄NO₃ (g/mol)
- M(N₂) - Molar Mass of N₂ (g/mol)



$$\text{CaCO}_3 \text{ in Nitrolusal}_{20.5\text{N}} = \text{Nitrolusal}_{20.5\text{N}} \times \left[100\% - \left(\% \text{N}_2 \text{ in Nitrolusal}_{20.5\text{N}} \times \frac{M(\text{NH}_4\text{NO}_3)}{M(\text{N}_2)} \right) \right]$$

Where:

- $\text{CaCO}_3 \text{ in Nitrolusal}_{20.5\text{N}}$ - Amount of CaCO_3 in fertilizer used with 20.5% N in its constitution (kg of CaCO_3)
- $\text{Nitrolusal}_{20.5\text{N}}$ - Amount of fertilizer used with 20.5% N in its constitution (kg of Nitrolusal_{27N} fertilizer)
- $\% \text{N}_2 \text{ in Nitrolusal}_{20.5\text{N}}$ - % of N_2 in the fertilizer used with 20.5% N in its constitution (% mass/mass) = 20.5%
- $M(\text{NH}_4\text{NO}_3)$ - Molar Mass of NH_4NO_3 (g/mol)
- $M(\text{N}_2)$ - Molar Mass of N_2 (g/mol)

- Step 4 -

$$\text{CO}_2 \text{ from Nitrolusal}_{27\text{N}} = \text{CaCO}_3 \text{ in Nitrolusal}_{27\text{N}} \times \frac{M(\text{CO}_2)}{M(\text{CaCO}_3)}$$

Where:

- $\text{CO}_2 \text{ from Nitrolusal}_{27\text{N}}$ - CO_2 emissions from the application of fertilizer used with 27% N in its constitution (kg of CO_2)
- $\text{CaCO}_3 \text{ in Nitrolusal}_{27\text{N}}$ - Amount of CaCO_3 in fertilizer used with 27% N in its constitution (kg of CaCO_3)
- $M(\text{CO}_2)$ - Molar Mass of CO_2 (g/mol)
- $M(\text{CaCO}_3)$ - Molar Mass of CaCO_3 (g/mol)

$$\text{CO}_2 \text{ from Nitrolusal}_{20.5\text{N}} = \text{CaCO}_3 \text{ in Nitrolusal}_{20.5\text{N}} \times \frac{M(\text{CO}_2)}{M(\text{CaCO}_3)}$$

Where:

- $\text{CO}_2 \text{ from Nitrolusal}_{20.5\text{N}}$ - CO_2 emissions from the application of fertilizer used with 20.5% N in its constitution (kg of CO_2)
- $\text{CaCO}_3 \text{ in Nitrolusal}_{20.5\text{N}}$ - Amount of CaCO_3 in fertilizer used with 20.5% N in its constitution (kg of CaCO_3)
- $M(\text{CO}_2)$ - Molar Mass of CO_2 (g/mol)
- $M(\text{CaCO}_3)$ - Molar Mass of CaCO_3 (g/mol)



5.10.3 Emission factors

It were used the default emission factor for carbon conversion of 0.12 which is equivalent to carbonate carbon contents of limestone in an atomic basis.

Table 5-56: Molar Mass of Ca, C, O, CaCO₃ and CO₂

Parameter	Unit	Molar Mass
N ₂	g/mol	28
NH ₄ NO ₃	g/mol	80
Ca	g/mol	40
C	g/mol	12
O	g/mol	16
CaCO ₃	g/mol	100
CO ₂	g/mol	44

5.10.4 Activity Data

Data on nitrogen fertilizers consumption, CAN included, are provided by INE and are obtained as it was explained in chapter 5.5.1.4.1 - Synthetic Fertilizers (activity data).

The total amount of CAN fertilizer use and the corresponding CaCO₃ amount are shown in the next figure.

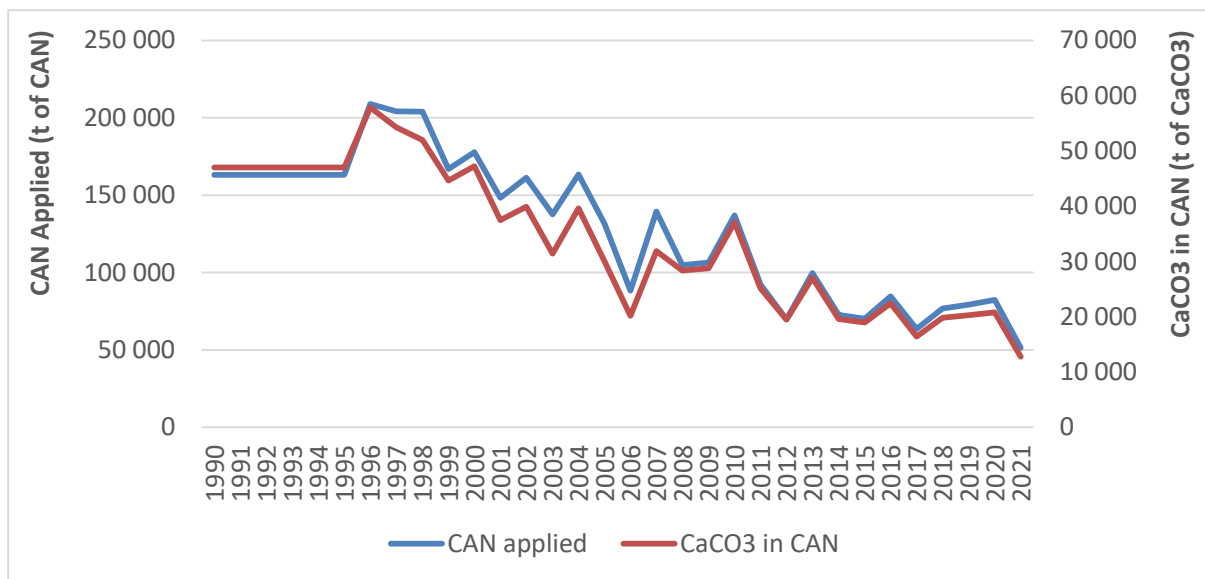

Figure 5-60: Calcium Ammonium Nitrate (CAN) applied to soils and corresponding CaCO₃ amount

5.10.5 Uncertainty Assessment

Under the IPCC 2006 Tier 1 methodology, the default emission factor was used, which assume conservatively that all carbon in the CAN fertilizer is emitted as CO₂ into the atmosphere. The default emission factor represents the absolute maximum emissions associated with urea fertilization so is assumed certain.

The uncertainty of activity data, apparent consumption of CAN, was assumed the same that was considered for N synthetic fertilizers in direct N₂O emissions from managed soils, i.e., 29.3%.



5.10.6 Category specific QA/QC and verification

QA/QC procedures included a series of checks: calculation formulas verification, data collection verification and the information provided in this report.

5.10.7 Category specific recalculations

Activity data timeseries has been revised from 1995 onwards based on National Statistics update.

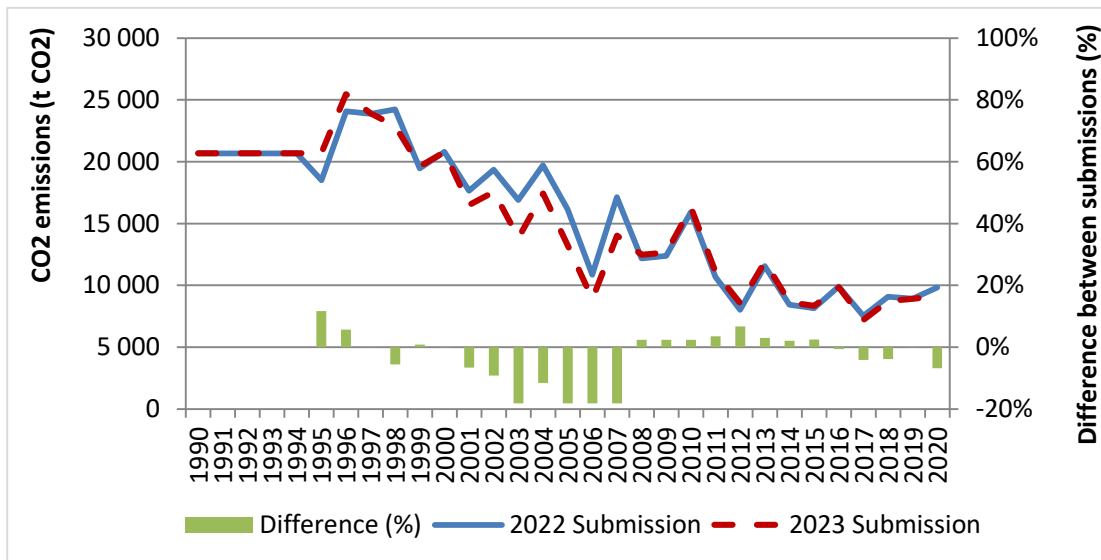

Figure 5-61: CO₂ emissions differences between 2022 and 2023 submissions (%)

5.10.8 Category specific planned improvements

No specific improvements are planned.

6 Land-Use, Land-Use Change and Forestry (CRF Sector 4)

Table of Contents

6	Land-Use, Land-Use Change and Forestry (CRF Sector 4)	6-1
6.1	Overview of LULUCF	6-5
6.1.1	LULUCF Inventory Framework	6-5
6.1.2	Representation of Land-Areas and Land-Use Changes	6-6
6.1.3	Generic Methodologies and Information Sources Applicable to Multiple Land-Use Categories..	6-18
6.2	Forest Land (CFR 4.A)	6-26
6.2.1	Forest Land Remaining Forest Land	6-26
6.2.2	Land Converted to Forest	6-31
6.3	Cropland (CRF 4.B)	6-32
6.3.1	Cropland Remaining Cropland	6-32
6.3.2	Land Converted to Cropland	6-33
6.4	Grassland (CRF 4.C)	6-35
6.4.1	Grassland Remaining Grassland	6-35
6.4.2	Land Converted to Grassland	6-36
6.5	Wetlands (CRF 4.D)	6-38
6.5.1	Wetlands remaining wetlands	6-38
6.5.2	Lands converted to wetlands	6-39
6.6	Settlements (CFR 4.E)	6-40
6.6.1	Settlements remaining settlements	6-40
6.6.2	Lands converted to settlements	6-41
6.7	Other Land (CRF 4.F)	6-42
6.8	Harvested Wood Products (CRF 4.G)	6-43
6.9	Direct N ₂ O Emissions from N-Inputs to Managed Soils (CRF 4(I))	6-44
6.10	Emissions and Removals from Drainage and Rewetting and other Management of Organic and Mineral soils (CRF 4(II))	6-44



6.11	Direct N ₂ O emissions from N Mineralization/Immobilization associated with Loss/Gain of Soil Organic Matter resulting from change of LU or management of Mineral Soils (CRF 4(III)).....	6-45
6.11.1	Activity Data	6-45
6.11.2	Emission estimation	6-45
6.12	Indirect N ₂ O Emissions from managed soils (CRF 4(IV)).....	6-46
6.13	Emissions from Biomass Burning (CRF 4(V)).....	6-48
6.13.1	Estimation of Burnt Areas	6-48
6.13.2	Estimation of Biomass Loss due to Fires	6-49
6.13.3	Direct CO ₂ Emissions from Fires	6-50
6.13.4	Direct CH ₄ Emissions from Fires	6-50
6.13.5	Direct N ₂ O Emissions from Fires.....	6-50
6.13.6	Indirect CO ₂ Emissions from Fires	6-51
6.14	Uncertainty Assessment.....	6-52
6.15	QA/QC.....	6-52
6.16	Recalculations and Data Improvements.....	6-52
6.17	Further Developments.....	6-53

List of Figures

Figure 6-1: Overview of emissions and removals in the LULUCF Sector.....	6-5
Figure 6-2: Portuguese Territorial Units.....	6-6
Figure 6-3: Map of the main land-uses in Mainland Portugal in 1995 and 2018 – Forest Land	6-9
Figure 6-4: Map of the main land-uses in Mainland Portugal in 1995 and 2018 - Cropland	6-9
Figure 6-5: Map of the main land-uses in Mainland Portugal in 1995 and 2018 – Grassland and Settlements	6-10
Figure 6-6: Map of the main land-uses in Mainland Portugal in 1995 and 2018 – Wetlands and Other Land	6-10
Figure 6-7: Trend in GL1 “Pastures”, ST1 “Settlements” and WT1 “Flooded Areas”	6-12
Figure 6-8: Changes in Total Land-Use in Mainland Portugal (1000 ha)	6-13
Figure 6-9: Changes in Total Land-Use in the Region of Azores.....	6-15
Figure 6-10: Changes in Total Land-Use in the Region of Madeira	6-16
Figure 6-11: Changes in Total Land-Use in Portugal.....	6-16
Figure 6-12: Total Areas per UNFCCC Reporting Categories	6-17
Figure 6-13: Default IPCC BCEF Factors Used According to Average Standing Volume	6-19
Figure 6-14: Default IPCC RTS Factors Used According to Average Standing Volume	6-19
Figure 6-15: Areas of Forest Land per UNFCCC Reporting Category.....	6-26



Figure 6-16: Total Emissions and Removals in Forest Land.....	6-26
Figure 6-17: Industrial Harvest per Forest Type.....	6-29
Figure 6-18: Other Wood Use per Forest Type	6-29
Figure 6-19: Areas of Cropland per UNFCCC Reporting Category.....	6-32
Figure 6-20: Total Emissions and Removals in Cropland.....	6-32
Figure 6-21: Areas of Grassland per Reporting Category (1000 ha).....	6-35
Figure 6-22: Total Emissions and Removals in Grassland.....	6-35
Figure 6-23: Areas of Wetlands per Reporting Category (1000 ha)	6-38
Figure 6-24: Total Emissions and Removals in Wetlands (kt CO ₂ e).....	6-38
Figure 6-25: Areas of Settlements per Reporting Category	6-40
Figure 6-26: Total Emissions and Removals in Settlements	6-40
Figure 6-27: Areas of Other Land per Reporting Category.....	6-42
Figure 6-28: Reported Activity Data for Harvested Wood Products – Sawnwood	6-43
Figure 6-29: Reported Activity Data for Harvested Wood Products – Wood Pannels.....	6-43
Figure 6-30: Reported Activity Data for Harvested Wood Products – Paper and Paper Board	6-44
Figure 6-31: Evolution of Carbon Stocks and Carbon Stock Changes in Harvested Wood Products	6-44
Figure 6-32: Total Area under N Mineralization (kha).....	6-45
Figure 6-33: N ₂ O Emissions from Areas under N Mineralization (kt N ₂ O)	6-46
Figure 6-34: Total N Lost per Source	6-46
Figure 6-35: Total Indirect N ₂ O Emissions	6-47
Figure 6-36: Burnt Areas per Reporting Category (ha).....	6-49
Figure 6-37: Estimation of Indirect Fire Emissions	6-51
Figure 6-38: Total Emissions from Biomass Burning per Land-use Category.....	6-52
Figure 6-39: Effect of recalculations in the Total LULUCF Emissions and Removals.....	6-53

List of Tables

Table 6-1: Land-use categories used in the estimation of emissions and removals in LULUCF.....	6-7
Table 6-2: Annual land-use changes (ha) in Mainland Portugal the period 1970-1995.....	6-14
Table 6-3: Total Carbon Stocks and Annual Growth Rates per Forest Type	6-18
Table 6-4: Above and Below Ground Biomass in Permanent Crops, According to Age after Plantation.....	6-19
Table 6-5: Carbon Stock Annual Gains in Above and Below Ground Biomass in Permanent Crops, According to Age after Plantation	6-20
Table 6-6: Carbon Stock Annual Gains and Losses related to Pruning of Above Ground Biomass in Permanent Crops, According to Age after Plantation	6-20



Table 6-7: Above and Below Ground Biomass in Shrublands, According to Age	6-20
Table 6-8: Carbon Stock Annual Gains in Above and Below Ground Biomass in Shrublands, According to Age	6-21
Table 6-9: Above and Below Ground Biomass and Annual Carbon Stock Gains and Losses in Annual Crops, Pastures and Wetlands.....	6-21
Table 6-10: Litter Carbon Stocks at Maturity by Land-Use.....	6-22
Table 6-11: Annual Emission/Sequestration Factors for Litter	6-22
Table 6-12: Number of sample plots per land-use and soil depth	6-23
Table 6-13: Average C Stock measured per land-use and soil depth	6-23
Table 6-14: Average C Stock 0-40 cm per land-use	6-24
Table 6-15: Annual Emission/Sequestration Factors for Soil	6-25
Table 6-16: Summary of types of losses in living biomass considered in the estimations of emissions and removals in forest land	6-28
Table 6-17: Combustion Factors per Biomass Component used in the Estimation of Fire Emissions	6-49
Table 6-18: Fire Mortality Rates	6-51

List of Equations

Equation 6-1: Estimation of annual land-use change 1995-2018	6-10
Equation 6-2: Estimation of Land-use Changes, when only net-changes in area are known	6-13
Equation 6-3: Estimation of Land Conversions for UNFCCC Reporting.....	6-17
Equation 6-4: Estimation of Land Remaining Land for UNFCCC Reporting.....	6-17
Equation 6-5: Estimation of Above Ground Living Biomass in Forests	6-18
Equation 6-6: Estimation of Below Ground Living Biomass in Forests.....	6-18
Equation 6-7: Estimation of Above Ground Living Biomass in Shrubland.....	6-20
Equation 6-8: Estimation of Litter Emission Factors	6-22
Equation 6-9: Estimation of Soil Emission Factors	6-24
Equation 6-10: Estimation of Above Ground Biomass Gains in Forest Land Remaining Forest Land.....	6-27
Equation 6-11: Estimation of Below Ground Biomass Gains in Forest Land Remaining Forest Land	6-27
Equation 6-12: Estimation of losses in living biomass in Forest Land Remaining Forest Land	6-30
Equation 6-13: Emissions from N ₂ O	6-45
Equation 6-14: Estimation of Direct CO ₂ Emissions from Fires	6-50
Equation 6-15: Estimation of Direct CH ₄ Emissions from Fires	6-50
Equation 6-16: Estimation of Direct N ₂ O Emissions from Fires.....	6-50



6 Land-Use, Land-Use Change and Forestry (CRF Sector 4)

Paulo Canaveira

Updated: March 2023

6.1 Overview of LULUCF

6.1.1 LULUCF Inventory Framework

When considered in its entirety, the LULUCF sector for the period 1990-2021 was on average estimated as a net-sink of -4.0 MtCO_{2eq}, as represented in Figure 6-1.

However, there is considerable inter-annual variability, including 6 years for which LULUCF was a net-emitter. The highest net-emission occurred in 2017 (+21.5 MtCO_{2eq}) and the highest net-sequestration occurred in 2009 (-10.4 MtCO_{2eq}). In 2021 the LULUCF sector emissions and removals are estimated as a net-sink of -6.0 MtCO_{2eq}.

The main contributors for the observed inter-annual variations are the wildfires, largely driven by changes in weather patterns from year to year. 2017 was particularly hard hit by fires, and a record high value of 558kha of burnt area was achieved (6% of the country).

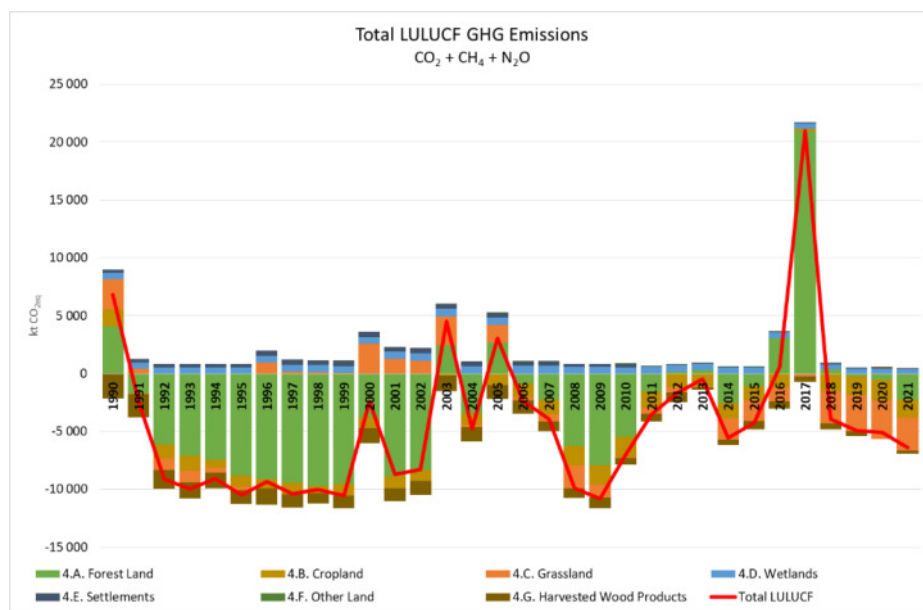

Figure 6-1: Overview of emissions and removals in the LULUCF Sector



6.1.2 Representation of Land-Areas and Land-Use Changes

6.1.2.1 Approaches to Land Representation

The Portuguese territory is composed of three territorial units (see Figure 6-2): Mainland, the Archipelago of Azores (9 inhabited islands) and the Archipelago of Madeira (2 inhabited islands).

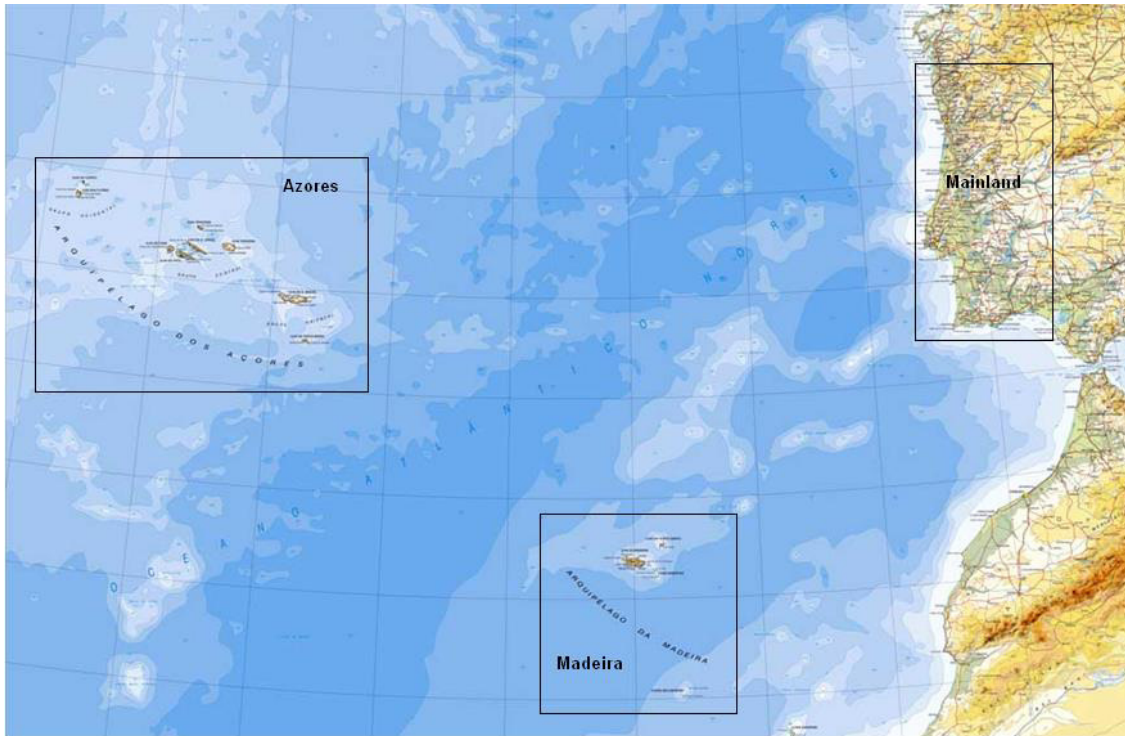

Figure 6-2: Portuguese Territorial Units

Portugal has 9 239 318 ha, divided by the Mainland with 8 927 540 ha (96.6%), the Archipelago of Azores with 231 676 ha (2.5%) and Archipelago of Madeira with 80 102 ha (0.9%).

Under the Portuguese constitutional law, the Archipelagos of Azores and Madeira are each an Autonomous Region, and as a result of that legal status the information sources (used for activity data) for each region are not exactly the same.

The sections below describe how the data on land-use and land-use change were derived in each of the three regions. The approaches used vary according to territory and time period under consideration from Approach 1 (total land-use area, no data on conversions between land-uses) and Approach 3 (spatially-explicit land-use conversion data), with predominance for the later.

6.1.2.2 Land-Use Data Stratification

The same land-use stratification is used in all three regions, despite the different sources of land-use data used in each of the regions.

A total of 21 land-use categories were used as shown in Table 6-1.



Table 6-1: Land-use categories used in the estimation of emissions and removals in LULUCF

UNFCCC Category	Land-use Category Name	Description
FL: Forest Land	FL1: Pinus pinaster	Forests dominated by maritime pine
	FL2: Pinus pinea	Forests dominated by umbrella pine
	FL3: Other coniferous	Forests dominated by any other coniferous species
	FL4: Eucalyptus spp.	Forests dominated by eucalypt species
	FL5: Quercus suber	Forests dominated by cork oak
	FL6: Quercus rotundifolia	Forests dominated by holm oak
	FL7: Quercus spp.	Forests dominated by other oak species
	FL8: Other broadleaves	Forests dominated by any other broadleaf species
CL: Cropland	CL1: Rainfed annual crops	Includes all land cultivated with annual crops without irrigation Includes fallow-land integrated into crop-rotations
	CL2: Irrigated annual crops	Includes all land cultivated with annual crops that is under irrigation (except rice), nurseries and greenhouses
	CL3: Rice paddies	Includes all land prepared for rice cultivation
	CL4: Vineyards	Includes all areas used for cultivation of table and/or wine grapes
	CL5: Olive groves	Includes all areas used for cultivation of Olea europea ¹
	CL6: Other permanent crops	Includes all areas used for cultivation of all other species of woody crops, including fruit orchards ²
GL: Grassland	GL1: All grasslands	Includes all lands covered in permanent herbaceous cover
	GL2: Shrubland	Includes all lands covered in woody vegetation that do not meet the forest or permanent crop definitions
WT: Wetlands	WT1: Flooded areas	Includes all lands permanently covered in water, such as water reservoirs and inland natural lagoons, lakes and estuaries
	WT2: Wetlands	Includes all natural wetlands that do not meet the Flooded areas definition
ST: Settlements	ST1: Settlements	Includes all artificial territories, including cities and villages, industries, mines, roads and railway, ports and airports
OL: Other Land	OL1: Other land	Includes all lands that do not meet the previous definitions, such as lands covered in rocks, sand dunes, etc
	OO1: Oceans	Includes natural or man-made land-use change transitions to or from Oceans ³

¹ Olive trees used for the production of olive oil and/or olives. The Wild Olive Tree (sub-species *Olea europea sylvestris*) is reported as Forest Land / Other Broadleaves

² Except Sweet Chestnut (*Castanea sativa*), Carob Trees (*Ceratonia siliqua*) and Umbrella Pines (*Pinus pinea*), which are reported to FAO as forest land, even though their main production objective is the respective fruit.

³ E.g. construction or expansion of a sea port; natural expansion or loss of sand dunes along the coastline. NB: Only land-use changes are considered; emissions and removals from oceans as such are not included.



6.1.2.3 Mainland Portugal

The land-use and land-use change data for Mainland Portugal 1970-2021 was divided into two different time periods: 1970-1995 and 1995-2018.

This separation was needed due to the type and quality of information available, where the period 1995-2018 can be estimated using an approach type 3 (spatially-explicit land-use conversion data), while the data for the period 1970-1995 only allowed for the use of an approach type 1 (total land-use area, no data on conversions between land-uses).

The methodologies used for each of the periods are described below.

6.1.2.3.1 Period 1995-2021

The main information source for this period is the Cartografia de Ocupação de Solo⁴ (COS). COS was last updated in 2018 and now includes maps for the years 1995, 2007, 2010, 2015 and 2018.

COS legend was consistent in all maps. The extensive legend was after converted to the 21 strata described in section 6.1.2.2, which are used as a basis for both UNFCCC and KP reporting. The minimum area considered was 1ha and the minimum width for linear structures and other polygons was 20m. Forest classes considered where forest tree cover was bigger than 10% and include also areas temporarily unstocked. This allows for a representation of forests consistent with the KP Forest Definition of Portugal.

COS (2007) was the first to be produced and was used as a basis to derive COS (1995) and COS (2010), using the full aerial photography cover of mainland Portugal available for the respective years. COS (2012) and COS (2018) were derived from the previous map. This approach minimises the chances for topological and geometric problems between maps.

In the 2018 exercise an additional QA/QC check was conducted, by overlapping all maps and checking (and correcting when needed) for mistakes and/or very improbable land-use changes. As a consequence, all previous COS maps have been revised. An example is illustrated in the table below:

1995	2007	2010	2015	2018
Q. suber	Q. suber	Q. suber	Q. rotundifolia	Q. suber
The value for 2015 was identified as a mistake and corrected to:				
Q. suber	Q. suber	Q. suber	Q. suber	Q. suber

The Final Report of COS further elaborates on the criteria used for land classification and generalization.

⁴ Land-Use Cartography. COS in the Portuguese acronym

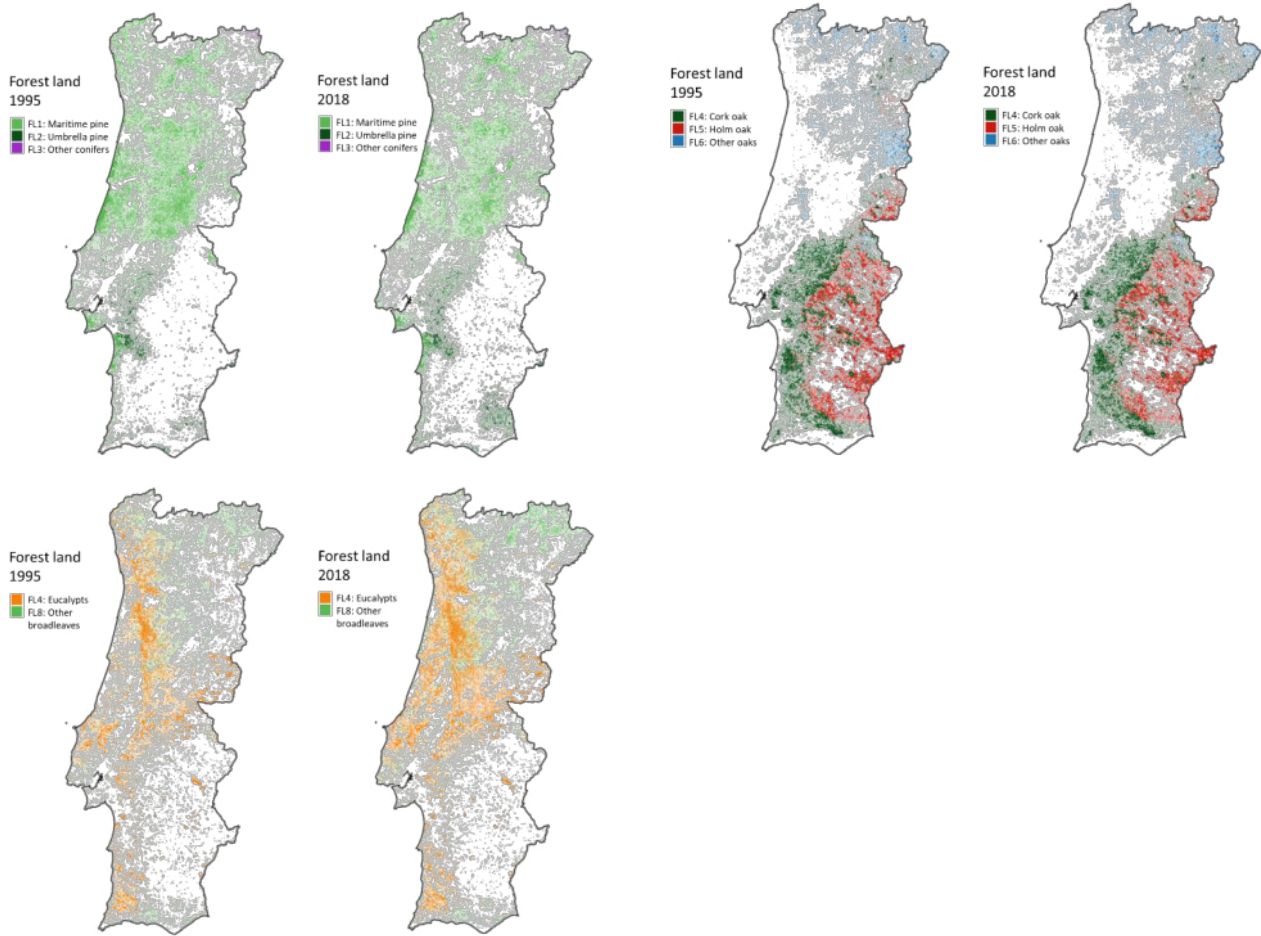

Figure 6-3: Map of the main land-uses in Mainland Portugal in 1995 and 2018 – Forest Land

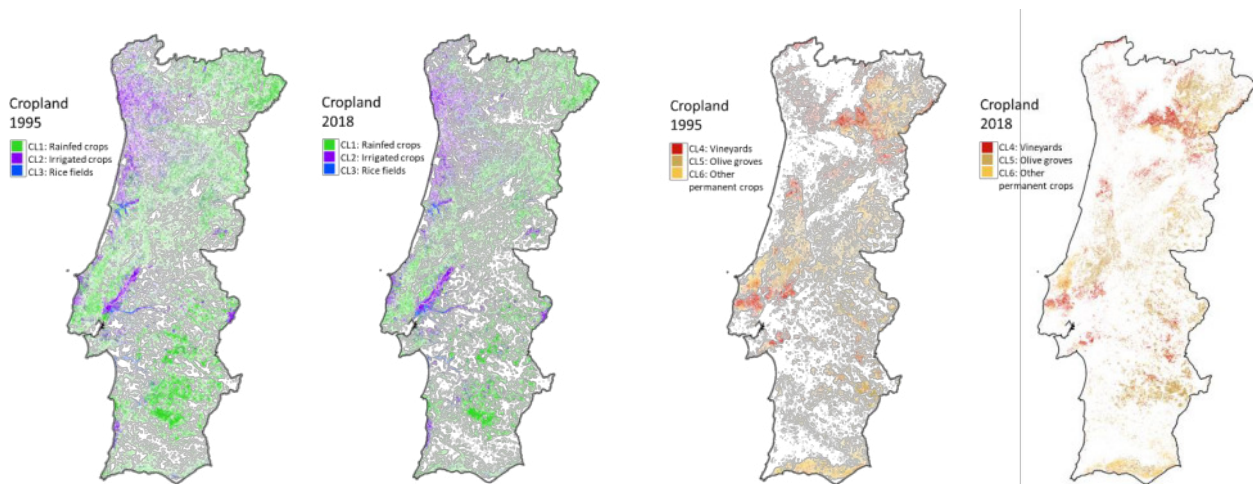

Figure 6-4: Map of the main land-uses in Mainland Portugal in 1995 and 2018 - Cropland

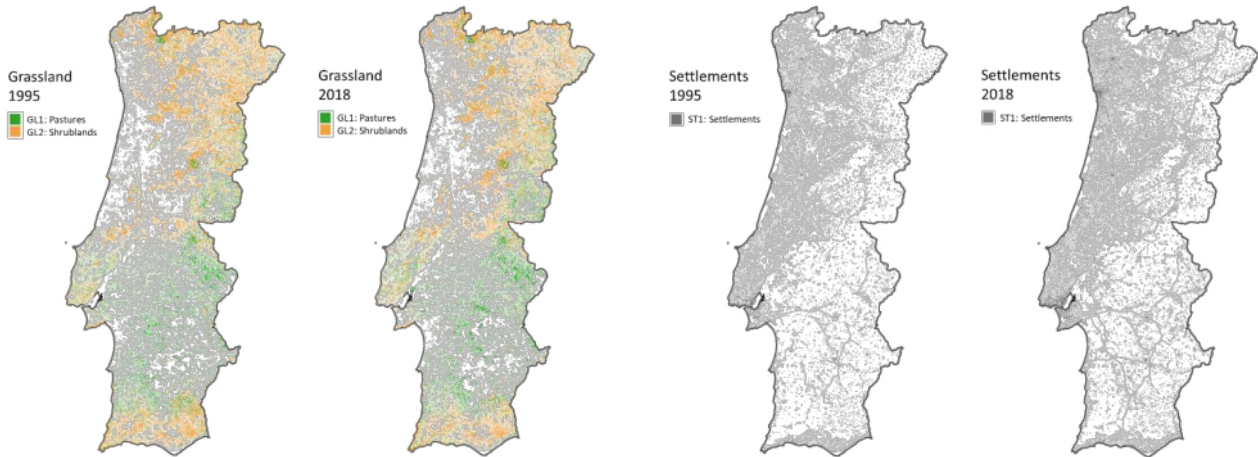

Figure 6-5: Map of the main land-uses in Mainland Portugal in 1995 and 2018 – Grassland and Settlements

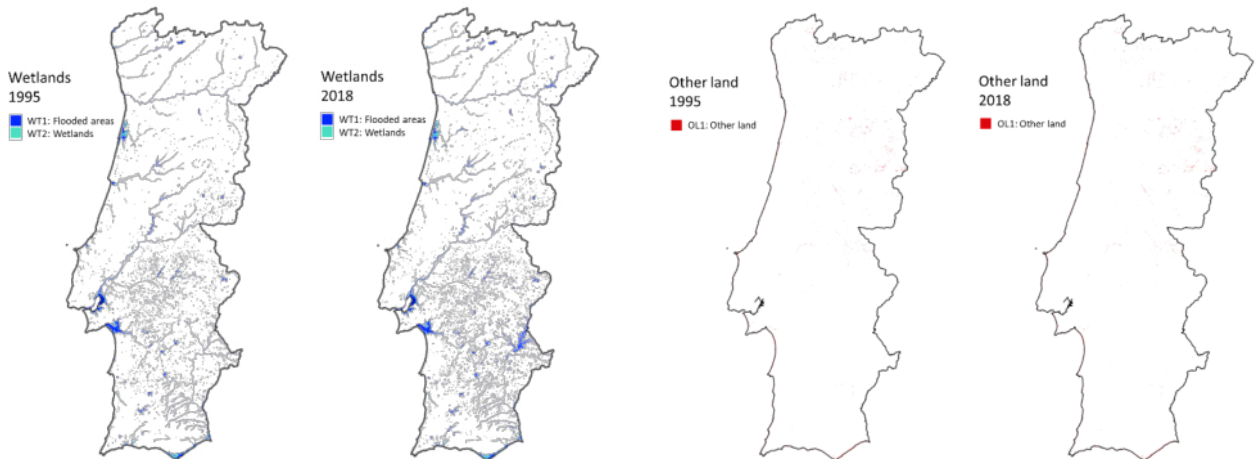

Figure 6-6: Map of the main land-uses in Mainland Portugal in 1995 and 2018 – Wetlands and Other Land

Total land-use changes were compiled for the periods 1995-2007, 2007-2010, 2010-2015 and 2015-2018 by overlapping the respective land-use maps. The results were then annualised by dividing for the period between maps (respectively 12, 3, 5 and 3 years). Land-use changes are assumed to be constant for the period 1995-2007 and 2007-2019 and equal to the annual land-use changes derived in those periods.

Equation 6-1: Estimation of annual land-use change 1995-2018

$$LUC_{x \rightarrow y}[Y_i] = \frac{LUC_{x \rightarrow y}[1995-2007]}{12}, Y_i = \text{any year in } [1995-2007]$$

$$LUC_{x \rightarrow y}[Y_i] = \frac{LUC_{x \rightarrow y}[2007-2010]}{3}, Y_i = \text{any year in } [2007-2010]$$

$$LUC_{x \rightarrow y}[Y_i] = \frac{LUC_{x \rightarrow y}[2010-2015]}{5}, Y_i = \text{any year in } [2010-2015]$$

$$LUC_{x \rightarrow y}[Y_i] = \frac{LUC_{x \rightarrow y}[2015-2018]}{3}, Y_i = \text{any year in } [2015-2018]$$

Where:

- $LUC_{x \rightarrow y}[1995-2007]$ = Total land-use change in the period 1995-2007 (ha)
- $LUC_{x \rightarrow y}[2007-2010]$ = Total land-use change in the period 2007-2010 (ha)
- $LUC_{x \rightarrow y}[2010-2015]$ = Total land-use change in the period 2010-2015 (ha)
- $LUC_{x \rightarrow y}[2015-2018]$ = Total land-use change in the period 2015-2018 (ha)
- $LUC_{x \rightarrow y}[Y_i]$ = Annual land-use change in Year i (ha/year)



For the years following 2018, the land-use changes are assumed to be equal to those of the previous period, i.e. to the trends of 2015-2018.

6.1.2.3.2 Period 1970-1995

As mentioned before, the data available from COS is contained to the period 1995-2010. For the period pre-1995, and starting from 1970, the information available is less comparable across sources and land-use classifications and, most importantly, it provides estimates for total land-uses, but not (directly) for land-use changes. Therefore, the approach differed between information source and land-use category.

For FL1-FL8 “Forest land” the basis for information was the National Forest Inventory from IFN2 (1974), IFN3 (1985) and IFN4 (1995).

However, there are differences in total areas per land use in COS and NFI. To maintain time series consistency, the following estimation methodology was used:

1. the linear trend for total forest area per species of IFN2 (1974) and IFN3 (1985) was applied to backcast an NFI estimate of total forest area per species in 1970;

	1970	1974	1985
	estimated 74/85	IFN2	IFN3
FL1	1 329 431	1 311 556	1 262 399

2. The “NFI” value for 1970 was then compared to the value in NFI 4 (1995) for the same species and a ratio between the 2 values was calculated;

	1970	1995	ratio
	NIF estimate	IFN4	70/95
FL1	1 329 431	986 532	1,348

3. This ratio was then applied to the COS 1995 forest area value to ensure a consistent value with the rest of the time series and a consistent trend with the observed values in the NFI

Forest NFI Data	1995	ratio	1970
	COS	70/95	final estimate
FL1	1 096 440	1,348	1 477 541

A similar approach was used for CL1-CL6 “Cropland”, but using as a basis for information the General Census of Agriculture from RGA (1979), RGA (1989) and RGA (1999).

However, there are differences in total areas per land use in COS and RGA. To maintain time series consistency, the following estimation methodology was used:

1. the linear trend for total area 1979-1989 was applied was applied to backcast an RGA estimate of total cropland area per type in 1970;

	1970	1979	1989
	estimated 79/89	RGA	RGA
CL1	1 463 578	1 596 130	1 743 410

2. the linear trend for total area 1989-1999 was applied was applied to interpolate an RGA estimate of total cropland area per type in 1995 (year of the first COS)

	1989	1999	1995	
	RGA89	RGA99	estimated 89/99	COS
CL1	1 743 410	1 093 437	1 353 426	1 301 933



3. The “RGA” value for 1970 was then compared to the value the “RGA” value for 1995 for the same cropland type and a ratio between the 2 values was calculated;

	1970	1995	ratio
	RGA estimate	RGA estimate	70/95
CL1	1 463 578	1 353 426	1,081

4. This ratio was then applied to the COS 1995 cropland type area value to ensure a consistent value with the rest of the time series and a consistent trend with the observed values in the RGA

	1995	ratio	1970
	COS	70/95	final estimate
CL1	1 301 933	1,081	1 407 894

For GL1 “Pastures”, ST1 “Settlements” and WT1 “Flooded Areas”, the value for 1970 was backcasted from the trend obtained in the time series from COS 1995-2018.

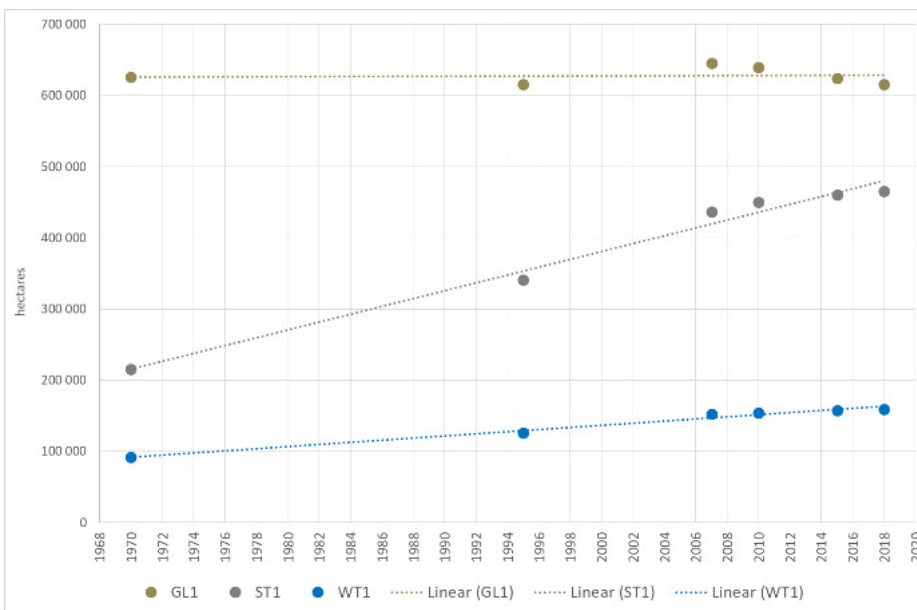

Figure 6-7: Trend in GL1 “Pastures”, ST1 “Settlements” and WT1 “Flooded Areas”

For OL1 “Other Land”, and WT2 “Wetlands”, categories with small total areas and very low LUC in the period 1995/2018, the value for 1970 was assumed to be the same as in COS 1995.

Finally, totals for Mainland Portugal were maintained constant in the period 1970-1995 by adjusting the category GL2 “Shrubland”. The results for the full time series 1970-2021 are presented in Figure 6-7.

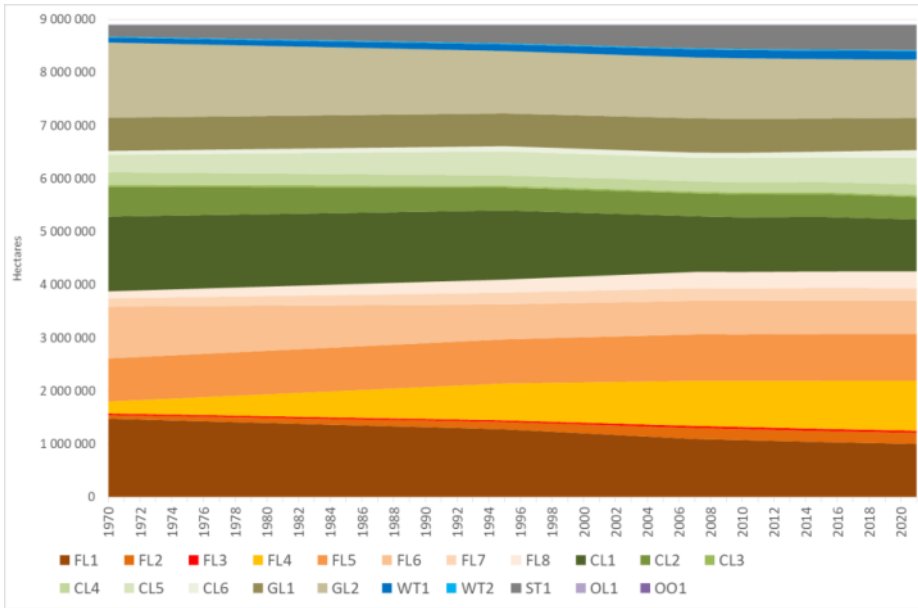

Figure 6-8: Changes in Total Land-Use in Mainland Portugal (1000 ha)

As mentioned above, land use changes for the period 1970-1995 cannot be estimated separately for X→Y (e.g. gross afforestation) and Y→X (e.g. gross deforestation), as the only information available is the total of net-changes in area in each period, i.e. X→Y plus Y→X (e.g. net gains in forest area).

However, as the country’s total remains constant over time, the total sum of net-gains in area of a particular set of land-uses needs to be equal to the net-losses in area of all other land-uses. This principle was applied to derive land-use change estimates for all land-uses using Equation 6-2.

Equation 6-2: Estimation of Land-use Changes, when only net-changes in area are known

$$LUC_{x \rightarrow y, Y_i} = \sum LUC_{x \rightarrow all, Y_i} \times \frac{\sum LUC_{all \rightarrow y, Y_i}}{\sum LUC_{all, Y_i}}$$

Where:

$LUC_{x \rightarrow y, Y_i}$ = Land-use change from land-use x to land-use y in Year i (ha);

Y_i = Any year in the period [1970-1995];

$\sum LUC_{x \rightarrow all, Y_i}$ = Net area loss of land-use type x in Year i (ha);

$\sum LUC_{all \rightarrow y, Y_i}$ = Net area gains of land-use type y in Year i (ha);

$\sum LUC_{all, Y_i}$ = Total land-use changes in Year i (ha).

The resulting annual land-use change matrices for this period are presented in Table 6.2.



Table 6-2: Annual land-use changes (ha) in Mainland Portugal the period 1970-1995

1970	1995	CL						FL								GL		OK	OO	ST	WT			Annual Losses 1970 - 1995
PT1		CL1	CL2	CL3	CL4	CL5	CL6	FL1	FL2	FL3	FL4	FL5	FL6	FL7	FL8	GL1	GL2	OK1	OO1	ST1	WT1	WT2		
						490,86	107,35	0,00	281,45	0,00	1 905,96	80,05	0,00	256,49	471,42	0,00	0,00	0,00	0,00	508,73	136,12	0,00	4 238,44	
						804,93	132,30	0,00	346,86	0,00	2 348,87	98,65	0,00	316,10	580,97	0,00	0,00	0,00	0,00	626,95	167,76	0,00	5 223,39	
						27,10	5,93	0,00	15,54	0,00	105,23	4,42	0,00	14,16	26,03	0,00	0,00	0,00	0,00	28,09	7,52	0,00	234,02	
						171,35	37,47	0,00	98,25	0,00	665,34	27,94	0,00	89,54	164,56	0,00	0,00	0,00	0,00	177,59	47,52	0,00	1 479,57	
								0,00	0,00	0,00	0,00	0,00	0,00	0,00	0,00	0,00	0,00	0,00	0,00	0,00	0,00	0,00	0,00	
								0,00	0,00	0,00	0,00	0,00	0,00	0,00	0,00	0,00	0,00	0,00	0,00	0,00	0,00	0,00	0,00	
						518,18	200,80		536,48		3 565,20	149,74		479,78	881,81	0,00	0,00	0,00	0,00	951,61	254,63	0,00	7 928,24	
																							0,00	
																							0,00	
						8,63	1,89		4,95		33,50	1,41		4,51	8,29	0,00	0,00	0,00	0,00	8,94	2,39	0,00	74,50	
																							0,00	
																							0,00	
						1 470,63	321,62		843,25		5 710,32	239,94		768,46	1 412,38					1 524,18	407,83	0,00	12 698,32	
																							0,00	
																							0,00	
						48,53	10,61	0,00	27,83	0,00	188,44	7,91	0,00	25,36	46,61					50,30	13,46	0,00	419,04	
																							0,00	
						1 103,15	241,26	0,00	632,54	0,00	4 283,44	179,91	0,00	576,44	1 059,46					1 143,32	305,92	0,00	9 525,45	
																							0,00	
																							0,00	
						0,31	-0,07	0,00	-0,18	0,00	-1,20	-0,05	0,00	-0,16	-0,30	0,00	0,00	0,00	0,00	-0,32	-0,09	0,00	-2,67	
																							0,00	
																							0,00	
																							0,00	
																							0,00	
																							0,00	
						4 843,04	1 059,17	0,00	2 776,97	0,00	18 805,10	789,83	0,00	2 530,68	4 651,24	0,00	0,00	0,00	0,00	5 019,40	1 343,07	0,00	41 818,49	
						5 902,21					29 553,82									5 019,40	1 343,07			

6.1.2.4 Autonomous Region of Azores and Autonomous Region of Madeira

For both the Azores and Madeira, the main sources of information available were:

1. Corine Land-Cover CLC (1990, 2000, 2006, 2012, 2018) – full wall-to-wall map
2. IFRAA (2007) – Regional Forest Inventory of the Autonomous Region of Azores
3. IFRAM (2004, 2010) – Regional Forest Inventory of the Autonomous Region of Madeira
4. RGA (1989, 1999, 2009) – General Census of Agriculture

The basis for the estimation of land-use and land-use change in the Azores and Madeira was CLC. The minimum area considered in each individual map was 25ha. All areas bigger than 1ha resulting from the interception of these maps were considered in subsequent analysis.

The interception of all CLC charts at the most detailed level showed considerable problems, most notably in the comparison of areas obtained by CLC and through other sources, like the IFRAA/IFRAM and the RGA. Therefore we decided not to use the full legend at that level. However the match between sources largely improved at higher levels of legend aggregation. Therefore the extensive CLC legend was converted into only 8 classes: “Cropland”; “Forest Land”; “Pastures”; “Shrubland”; “Settlements”; “Flooded Areas”; “Wetlands” and “Other Land”.

A further disaggregation into the 21 strata described in section 6.1.2.2, which are used as a basis for both UNFCCC and KP reporting, was made using the % distribution obtained from IFRAA/IFRAM or from the RGA.

For “Forest Land” the following estimation methodology was used:

1. The total area of forest land (in hectares) of CLC was used directly in the CLC reference years. In the remaining years total forest area was interpolated from the nearest CLCs. In addition, total area of forest was considered stable (i.e. no land-use change) in the period 1970-1990.
2. For the period 1970-2020 the following assumptions were made:
 - a. In Madeira,
 - i. the area per forest type in the period 1970-2003 was estimated from the annual total forest area multiplied by the share of that forest type in IFRAM 2004;
 - ii. the area per forest type in the period 2004-2010 was was estimated from the annual total forest area multiplied by the share of that forest type interpolated from the shares in IFRAM 2004 and IFRAM 2010
 - iii. the area per forest type in the period 2011-2020 was estimated from the annual total forest area multiplied by the share of that forest type in IFRAM 2010;



- b. In the Azores,
 - i. the area per forest type in the period 1970-2020 was estimated from the annual total forest area multiplied by the share of that forest type in IFRAA 2007;

For “Cropland” the following estimation methodology was used:

1. The total area of cropland (in hectares) of CLC was used directly in the CLC reference years. In the remaining years total forest area was interpolated from the nearest CLCs. In addition, total area of cropland was considered stable (i.e. no land-use change) in the period 1970-1990.
2. For the period 1970-2020 the following assumptions were made:
 - a. In Madeira and in the Azores,
 - i. the area per crop type in the period 1970-1989 was estimated from the annual total cropland area multiplied by the share of that crop type in RGA 1989;
 - ii. the area per crop type in the period 1990-1999 was estimated from the annual total cropland area multiplied by the share of that crop type interpolated from RGA 1989 and RGA 1999;
 - iii. the area per crop type in the period 2000-2009 was estimated from the annual total cropland area multiplied by the share of that crop type interpolated from RGA 1999 and RGA 2009;
 - iv. the area per crop type in the period 2010-2020 was estimated from the annual total cropland area multiplied by the share of that crop type in RGA 2009;
3. The total area of all remaining land-uses (in hectares) of CLC were used directly in the CLC reference years. In the remaining years total area per land-use type was interpolated from the nearest CLCs. In addition, total area per land-use was considered stable (i.e. no land-use change) in the period 1970-1990.

The results for the full time series 1970-2021 are presented in Figure 6-9 for the Azores, and in and Figure 6-10 for Madeira.

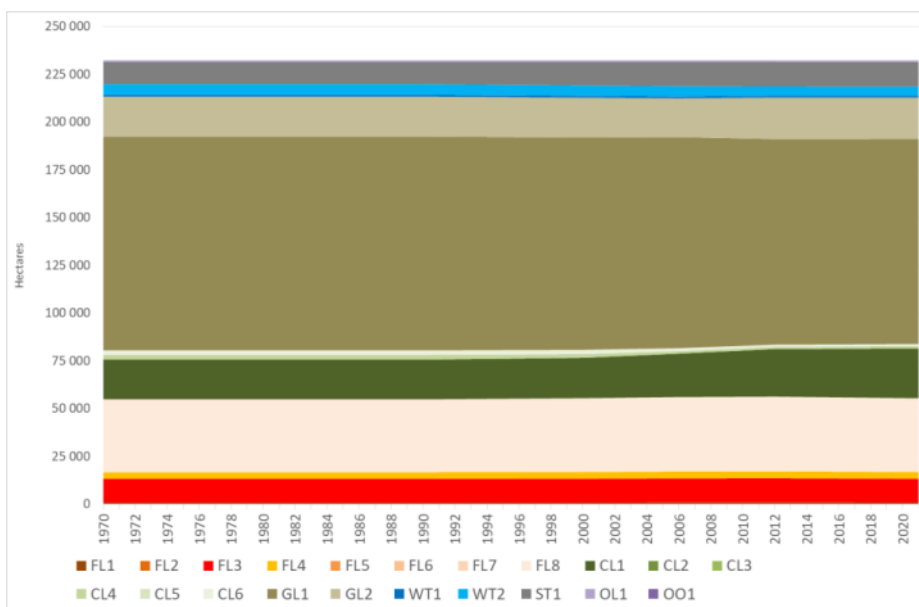

Figure 6-9: Changes in Total Land-Use in the Region of Azores

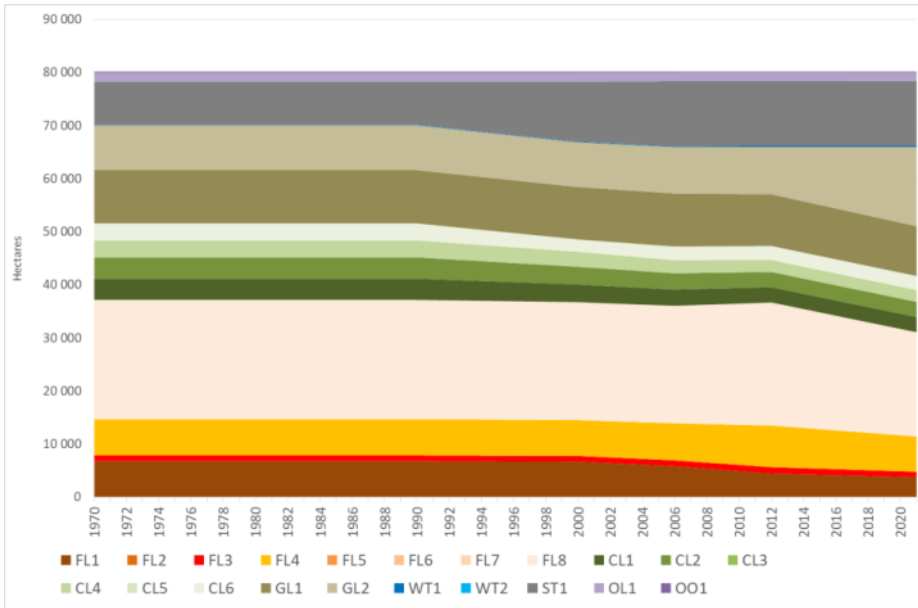

Figure 6-10: Changes in Total Land-Use in the Region of Madeira

6.1.2.5 Overview of Annual Land-Use Estimates for Portugal

The compilation of the estimates for land-use in Portugal, derived from the sum of the estimates made for Mainland Portugal, Azores and Madeira, as outlined in the previous sections, is presented in Figure 6-10.

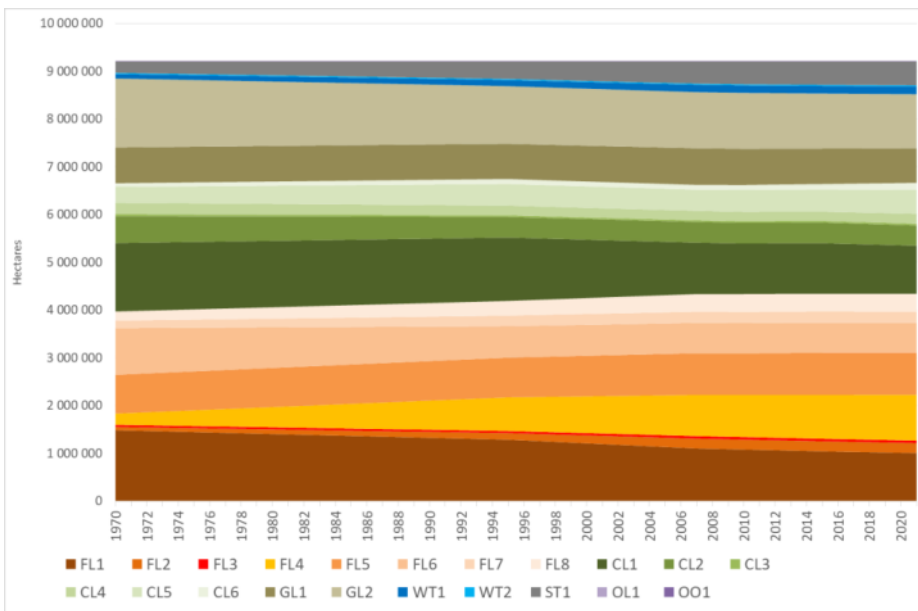

Figure 6-11: Changes in Total Land-Use in Portugal

6.1.2.6 Allocation of Land-use and Land-use Change to UNFCCC Reporting Categories

The allocation of each of the 21 land-use categories to each of the UNFCCC reporting categories was described in Table 6.1.

The allocation of land to the sub-categories land remaining land and land X converted to land Y was made using the annual land-use changes described in Table 6.2 through Table 6.8, assuming a 20 year conversion period, as shown in Equation 6-3.



Equation 6-3: Estimation of Land Conversions for UNFCCC Reporting

$$LC_{y \rightarrow x, RY_i} = \sum_{i=20}^i ALUC_{y \rightarrow x, i}$$

Where:

$LC_{y \rightarrow x, RY_i}$ = Land Y converted to Land X in reporting year i (ha)

$ALUC_{y \rightarrow x, i}$ = Annual Land-use change from Y to X (ha)

The area of “land remaining land” categories was estimated by the difference between the total area of each land use in each year subtracted from the land under that land-use considered in transition, as shown in Equation 6-4.

Equation 6-4: Estimation of Land Remaining Land for UNFCCC Reporting

$$LRL_{x, RY_i} = TA_{x, RY_i} - LC_{y \rightarrow x, RY_i}$$

Where:

LRL_{x, RY_i} = Land Y remaining Land X in reporting year i (ha)

TA_{x, RY_i} = Total Reported Area of land-use X in reporting year I, as shown in Figure 6-7 (ha)

$LC_{y \rightarrow x, RY_i}$ = Land Y converted to Land X in reporting year i (ha)

Land conversions within each broad UNFCCC reporting categories (e.g. changes from FL1 Maritime Pine to FL4 Eucalyptus) were also estimated and used for estimating emissions and removals, but were reported as “Land remaining Land” (in the previous example, as “forest land remaining forest land”).

Although some lands may be considered as unmanaged (e.g. GL2 Shrubland; WT2 Wetlands; OL1 Other Land) the area and emissions estimates include the total of the territory.

The results of this exercise are presented in Figure 6-12.

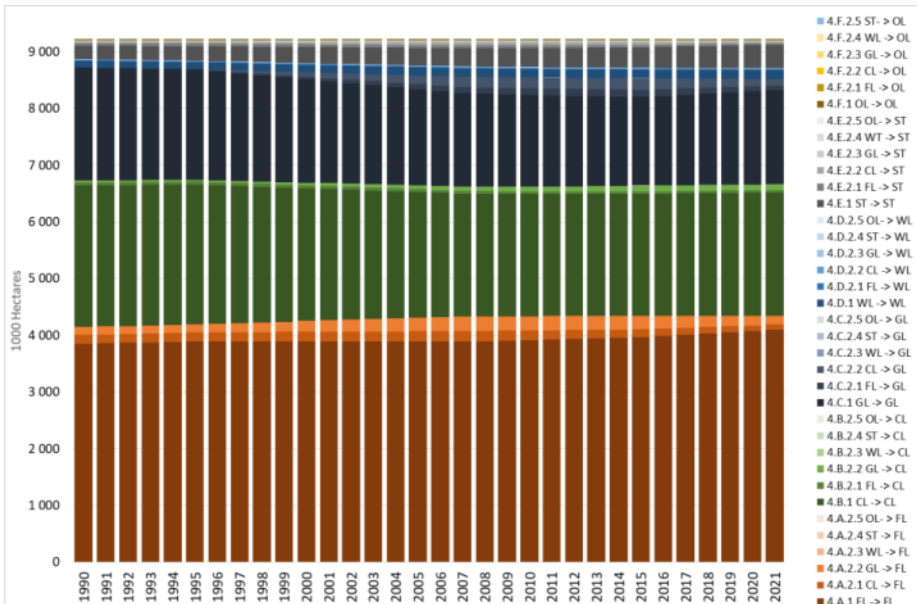

Figure 6-12: Total Areas per UNFCCC Reporting Categories



6.1.3 Generic Methodologies and Information Sources Applicable to Multiple Land-Use Categories

6.1.3.1 Biomass and Carbon Stocks, Gains and Losses

6.1.3.1.1 Forests (FL1-FL8)

In the case of forests, carbon stocks were estimated by converting standing volumes, through the Biomass Expansion Factors, Root-to-shoot ratios and Carbon fraction into total Carbon per unit of land. Carbon stocks were calculated separately for above and below ground biomass using Equation 6-5 to Equation 6-6.

Equation 6-5: Estimation of Above Ground Living Biomass in Forests

$$AGB_f = \sum_y AVol_{yf} \times BCEF_y \times CF_y$$

Equation 6-6: Estimation of Below Ground Living Biomass in Forests

$$BGB_f = \sum_y AVol_{yf} \times BCEF_y \times RTS_y \times CF_y$$

Where:

LB_f = Average Living Biomass of forest type f (tC/ha)

AGB_f = Average Above Ground Biomass of forest type f (tC/ha)

BGB_f = Average Below Ground Biomass of forest type f (tC/ha)

$AVol_{yf}$ = Average Standing Volume of forest species y in forest type f (m³/ha)

$BCEF_y$ = Biomass Conversion and Expansion Factor for forest species y

RTS_y = Root-to-Shoot Factor for forest species y

CF_y = Carbon Fraction for forest species y

Total Carbon in above ground living biomass stocks was derived from the National Forest Inventory, as shown in Table 6-3.

Growth rates were obtained by expert guess, involving a number of different experts from forest authorities, forest owners organisations and forest companies, and were assumed to be constant throughout the reporting period as shown also in Table 6-3.

Table 6-3: Total Carbon Stocks and Annual Growth Rates per Forest Type

		Increment m ³ .ha ⁻¹ .y ⁻¹	Total C Stock			
			NFI3 (1989) ktC	NFI4 (1995) ktC	NFI5 (2005) ktC	NFI6 (2015) ktC
FL1	Maritime Pine	5,5	41 437	38 371	33 261	28 073
FL2	Umbrella Pine	5,5	1 947	2 376	3 092	3 727
FL3	Other Coniferous	17,0	2 840	2 937	3 100	4 344
FL4	Eucalypts	15,0	25 008	28 600	34 589	34 069
FL5	Cork Oak	0,5	19 031	19 475	20 215	20 710
FL6	Holm Oak	0,5	10 857	10 871	10 895	10 037
FL7	Other Oaks	2,0	4 970	5 393	6 098	6 475
FL8	Other Broadleaves	4,0	7 184	8 519	10 746	16 374

The default IPCC 2006 Biomass Conversion and Expansion Factors BCEFs were used to derive above and below carbon stocks, gains and losses in Living Biomass. Default values were applied reflecting the average standing volume in each land-use unit as shown in Figure 6-13.

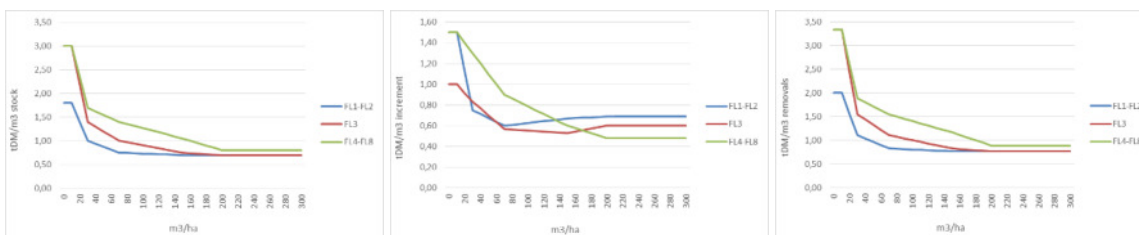

Figure 6-13: Default IPCC BCEF Factors Used According to Average Standing Volume

The carbon content of biomass per land-use type was assumed to be constant over time, and the default from IPCC 2006 (51% for conifers and 48% for broadleaves) was used. These values are used to convert biomass estimates into Carbon estimates.

The default IPCC 2006 Root-to-Shoot values were used to estimate belowground biomass. Default values were applied reflecting the average standing volume in each land-use unit as shown in Figure 6-14.

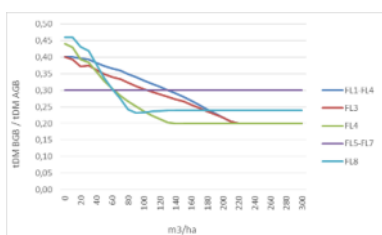

Figure 6-14: Default IPCC RTS Factors Used According to Average Standing Volume

6.1.3.1.2 Permanent Crops (CL4-CL6)

Data for Carbon Stocks and Gains and Losses in Permanent Crops was obtained from LIFE Project MediNet, which aimed to improve the transparency, consistency, comparability, completeness and accuracy of cropland and grassland reporting of emissions and removals in Mediterranean Countries (<https://www.lifemedinet.com/>).

The project focused on data collection and analysis from carbon and biomass assessments in Mediterranean Countries, mainly in Portugal, Italy and Spain. Growth curves were derived for Olive Orchards, Vineyards and Other Permanent Crops.

The carbon stock data by age after planting is shown in Table 6-4. This data was then used to derive C stock Gains as shown in Table 6-5.

Table 6-4: Above and Below Ground Biomass in Permanent Crops, According to Age after Plantation

AGB C Stock	age of orchard																				
	1	2	3	4	5	6	7	8	9	10	11	12	13	14	15	16	17	18	19	20	50
CL4	0,37	0,51	0,72	0,99	1,36	1,85	2,47	3,24	4,16	5,21	6,34	7,48	8,57	9,56	10,41	11,10	11,65	12,08	12,39	12,63	13,23
CL5	1,84	3,10	4,98	7,45	10,22	12,82	14,89	16,33	17,24	17,79	18,10	18,28	18,37	18,43	18,46	18,47	18,48	18,49	18,49	18,49	18,49
CL6	3,90	4,99	6,26	7,67	9,15	10,63	12,03	13,29	14,38	15,28	16,01	16,58	17,01	17,34	17,58	17,76	17,89	17,99	18,06	18,11	18,24
BGB C Stock	age of orchard																				
	1	2	3	4	5	6	7	8	9	10	11	12	13	14	15	16	17	18	19	20	50
CL4	0,75	1,00	1,31	1,68	2,13	2,65	3,22	3,81	4,41	4,97	5,48	5,92	6,29	6,59	6,83	7,01	7,15	7,26	7,34	7,40	7,56
CL5	0,31	0,60	1,10	1,81	2,59	3,27	3,72	3,99	4,13	4,20	4,23	4,25	4,26	4,26	4,26	4,26	4,26	4,26	4,26	4,26	4,26
CL6	1,76	2,31	2,97	3,74	4,58	5,44	6,29	7,08	7,77	8,36	8,83	9,20	9,48	9,69	9,85	9,96	10,05	10,11	10,15	10,18	10,26

unit:tC/ha



Table 6-5: Carbon Stock Annual Gains in Above and Below Ground Biomass in Permanent Crops, According to Age after Plantation

AGB C Stock Gains	age of orchard																				
	1	2	3	4	5	6	7	8	9	10	11	12	13	14	15	16	17	18	19	20	50
CL4	0,37	0,14	0,21	0,27	0,37	0,49	0,62	0,77	0,92	1,05	1,13	1,14	1,09	0,99	0,85	0,69	0,55	0,43	0,31	0,24	0,02
CL5	1,84	1,26	1,88	2,47	2,77	2,60	2,07	1,44	0,91	0,55	0,31	0,18	0,09	0,06	0,03	0,01	0,01	0,01	0,00	0,00	0,00
CL6	3,90	1,09	1,27	1,41	1,48	1,48	1,40	1,26	1,09	0,90	0,73	0,57	0,43	0,33	0,24	0,18	0,13	0,10	0,07	0,05	0,00
BGB C Stock Gains	age of orchard																				
	1	2	3	4	5	6	7	8	9	10	11	12	13	14	15	16	17	18	19	20	50
CL4	0,75	0,25	0,31	0,37	0,45	0,52	0,57	0,59	0,60	0,56	0,51	0,44	0,37	0,30	0,24	0,18	0,14	0,11	0,08	0,06	0,01
CL5	0,31	0,29	0,50	0,71	0,78	0,68	0,45	0,27	0,14	0,07	0,03	0,02	0,01	0,00	0,00	0,00	0,00	0,00	0,00	0,00	0,00
CL6	1,76	0,55	0,66	0,77	0,84	0,86	0,85	0,79	0,69	0,59	0,47	0,37	0,28	0,21	0,16	0,11	0,09	0,06	0,04	0,03	0,00

The “Above Ground Biomass” mentioned above relates to the total biomass after pruning. In addition to those, Gains and Losses in biomass related to pruning were also considered, with the assumption that biomass removed in each year by pruning is equal to an equivalent growth in the same year. It is also assumed that pruning growth and losses do not affect below ground biomass. The values used are shown in Table 6-6.

Table 6-6: Carbon Stock Annual Gains and Losses related to Pruning of Above Ground Biomass in Permanent Crops, According to Age after Plantation

AGB Pruning Gains	age of orchard																				
	1	2	3	4	5	6	7	8	9	10	11	12	13	14	15	16	17	18	19	20	50
CL4	0,93	0,93	0,93	0,93	0,93	0,93	0,93	0,93	0,93	0,93	0,93	0,93	0,93	0,93	0,93	0,93	0,93	0,93	0,93	0,93	0,93
CL5	0,56	0,74	0,98	1,26	1,58	1,93	2,29	2,63	2,95	3,23	3,47	3,65	3,80	3,91	3,99	4,05	4,10	4,13	4,15	4,17	4,21
CL6	0,74	0,92	1,13	1,37	1,61	1,86	2,11	2,34	2,55	2,73	2,88	3,00	3,10	3,18	3,25	3,29	3,33	3,36	3,38	3,40	3,44
AGB Pruning Losses	age of orchard																				
	1	2	3	4	5	6	7	8	9	10	11	12	13	14	15	16	17	18	19	20	50
CL4	-0,93	-0,93	-0,93	-0,93	-0,93	-0,93	-0,93	-0,93	-0,93	-0,93	-0,93	-0,93	-0,93	-0,93	-0,93	-0,93	-0,93	-0,93	-0,93	-0,93	-0,93
CL5	-0,56	-0,74	-0,98	-1,26	-1,58	-1,93	-2,29	-2,63	-2,95	-3,23	-3,47	-3,65	-3,80	-3,91	-3,99	-4,05	-4,10	-4,13	-4,15	-4,17	-4,21
CL6	-0,74	-0,92	-1,13	-1,37	-1,61	-1,86	-2,11	-2,34	-2,55	-2,73	-2,88	-3,00	-3,10	-3,18	-3,25	-3,29	-3,33	-3,36	-3,38	-3,40	-3,44

6.1.3.1.3 Shrublands (GL2)

For estimating above ground biomass the model proposed by Olson (1963) and adjusted for Portugal by Rosa (2009) was used.

Equation 6-7: Estimation of Above Ground Living Biomass in Shrubland

$$AGB_s = 18.86 \times (1 - e^{-0.23t}) \times CF_s$$

Where:

AGB_s = Average Above Ground Biomass of shrubs (t C/ha)

t = time in years

CF_s = Carbon Fraction for shrubs

The IPCC 2006 default for Carbon Fraction was used (47%). A constant Root-to-Shoot factor of 0.563 was used to estimate Below Ground Biomass. The application of the equation above resulted in the Carbon Stocks referred to in Table 6-7, and in the Carbon Stock Gains referred to in Table 6-8.

Table 6-7: Above and Below Ground Biomass in Shrublands, According to Age

AGB C Stock	age of shrubland																				
	1	2	3	4	5	6	7	8	9	10	11	12	13	14	15	16	17	18	19	20	50
GL2	1,82	3,27	4,42	5,33	6,06	6,63	7,09	7,46	7,75	7,98	8,16	8,30	8,42	8,51	8,58	8,64	8,69	8,72	8,75	8,78	8,86
BGB C Stock	age of shrubland																				
	1	2	3	4	5	6	7	8	9	10	11	12	13	14	15	16	17	18	19	20	50
GL2	1,03	1,84	2,49	3,00	3,41	3,74	3,99	4,20	4,36	4,49	4,59	4,67	4,74	4,79	4,83	4,86	4,89	4,91	4,93	4,94	4,99



Table 6-8: Carbon Stock Annual Gains in Above and Below Ground Biomass in Shrublands, According to Age

AGB	age of shrubland																				
	1	2	3	4	5	6	7	8	9	10	11	12	13	14	15	16	17	18	19	20	50
C Stock	1,82	3,27	4,42	5,33	6,06	6,63	7,09	7,46	7,75	7,98	8,16	8,30	8,42	8,51	8,58	8,64	8,69	8,72	8,75	8,78	8,86
BGB	age of shrubland																				
	1	2	3	4	5	6	7	8	9	10	11	12	13	14	15	16	17	18	19	20	50
C Stock	1,03	1,84	2,49	3,00	3,41	3,74	3,99	4,20	4,36	4,49	4,59	4,67	4,74	4,79	4,83	4,86	4,89	4,91	4,93	4,94	4,99

6.1.3.1.4 Annual Crops (CL1-CL3), Pastures (GL1) and Wetlands (WT2)

Data of biomass stocks was obtained from the EMEP/EEA air pollutant emission inventory guidebook 2019, chapter 11b, table 2.1. Values for CL1-CL3 were taken from the category “Grassland vegetated by annual grasses and forbs”, for GL1 from “Grassland vegetated by perennial grasses and forbs” and for WT2 from “Inland and coastal marshes”. Data on biomass was converted to Carbon Stocks by using the default IPCC 2006 value of 47%.

Default values for Root-to-Shoot from IPCC 2006 guidelines, volume 4, chapter 11, Table 11.2, were used, with the value for CL1-CL3 taken from “Grains”, and the values for GL1 and WT2 from “Perennial grasses”.

For annual crops and pastures, the assumption was made that this biomass is renewed annually, which means that stocks, annual gains and annual losses all share the same value. For wetlands it was assumed that the biomass took the default 20 years period to accumulate and, hence, gains and losses equal 1/20 of the total stock, in wetlands under 20years, and are zero after 20 years.

Table 6-9: Above and Below Ground Biomass and Annual Carbon Stock Gains and Losses in Annual Crops, Pastures and Wetlands.

tC	AGB			BGB		
	Stock	Gains	Losses	Stock	Gains	Losses
CL1	0,31	0,31	-0,31	0,07	0,07	-0,07
CL2	0,31	0,31	-0,31	0,07	0,07	-0,07
CL3	0,31	0,31	-0,31	0,07	0,07	-0,07
GL1	0,26	0,26	-0,26	0,21	0,21	-0,21
WT2 <20 years		0,11			0,08	
WT2 >20 years	2,11			1,68		
unit:tC/ha/y						

6.1.3.1.5 Other land uses (WT1, ST1, OL1, OO1)

For other land-uses no country specific or literature values were found. It is assumed that Biomass stocks are zero.

6.1.3.2 Litter

Litter data is not available from the NFI or from any other official data source. As an alternative, “typical” litter C stocks were used, based on the information contained in Rosa (2009), who used these values to estimate fire emissions from litter. This information was complemented, for non-forest land-uses, with default data from the EMEP/EEA Emission Inventory Guidebook 2009 (chapter 11b, Table 2-1). As a result, Portugal assumed constant values of litter stock for land remaining in the same land use, and changes in litter stocks are estimated only in cases of land-use changes. The values used are shown in Table 6-10.



Table 6-10: Litter Carbon Stocks at Maturity by Land-Use

Litter C Stock	
FL1	3,0
FL2	2,4
FL3	3,0
FL4	1,9
FL5	2,0
FL6	2,0
FL7	1,9
FL8	1,9
CL1	0,3
CL2	0,3
CL3	0,3
CL4	0,3
CL5	0,3
CL6	0,3
GL1	0,4
GL2	1,1
WT1	0,0
WT2	0,0
ST1	0,0
OL1	0,0
OO1	0,0
unit	tC/ha

Soil emission/sequestration factors were then calculated for all possible land-use changes considering the changes in average C Stocks for each land-use, as contained in Table 6-10 and a 20 year conversion period, as shown in Equation 6-8.

Equation 6-8: Estimation of Litter Emission Factors

$$LEF_{x \rightarrow y} = \frac{ALC_y - ALC_x}{20}$$

Where:

$LEF_{x \rightarrow y}$ = Litter Emission Factor for Land-use Change from x to y (tC/ha/year)

ALC_y = Average Litter Carbon Stock in Land Use y (tC/ha)

ALC_x = Average Litter Carbon Stock in Land Use x (tC/ha).

Table 6-11: Annual Emission/Sequestration Factors for Litter

Litter EF	to																				
	FL1	FL2	FL3	FL4	FL5	FL6	FL7	FL8	CL1	CL2	CL3	CL4	CL5	CL6	GL1	GL2	WT1	WT2	ST1	OL1	OO1
from	FL1	0,00	-0,03	0,00	-0,06	-0,05	-0,05	-0,06	-0,06	-0,14	-0,14	-0,14	-0,14	-0,14	-0,13	-0,10	-0,15	-0,15	-0,15	-0,15	-0,15
	FL2	0,03	0,00	0,03	-0,03	-0,02	-0,02	-0,03	-0,03	-0,11	-0,11	-0,11	-0,11	-0,11	-0,10	-0,07	-0,12	-0,12	-0,12	-0,12	-0,12
	FL3	0,00	-0,03	0,00	-0,06	-0,05	-0,05	-0,06	-0,06	-0,14	-0,14	-0,14	-0,14	-0,14	-0,13	-0,10	-0,15	-0,15	-0,15	-0,15	-0,15
	FL4	0,06	0,03	0,06	0,00	0,01	0,01	0,00	0,00	-0,08	-0,08	-0,08	-0,08	-0,08	-0,08	-0,08	-0,04	-0,10	-0,10	-0,10	-0,10
	FL5	0,05	0,02	0,05	-0,01	0,00	0,00	-0,01	-0,01	-0,09	-0,09	-0,09	-0,09	-0,09	-0,09	-0,08	-0,05	-0,10	-0,10	-0,10	-0,10
	FL6	0,05	0,02	0,05	-0,01	0,00	0,00	-0,01	-0,01	-0,09	-0,09	-0,09	-0,09	-0,09	-0,09	-0,08	-0,05	-0,10	-0,10	-0,10	-0,10
	FL7	0,06	0,03	0,06	0,00	0,01	0,01	0,00	0,00	-0,08	-0,08	-0,08	-0,08	-0,08	-0,08	-0,08	-0,04	-0,10	-0,10	-0,10	-0,10
	FL8	0,06	0,03	0,06	0,00	0,01	0,01	0,00	0,00	-0,08	-0,08	-0,08	-0,08	-0,08	-0,08	-0,08	-0,04	-0,10	-0,10	-0,10	-0,10
	CL1	0,14	0,11	0,14	0,08	0,09	0,09	0,08	0,08	0,00	0,00	0,00	0,00	0,00	0,00	0,01	0,04	-0,02	-0,02	-0,02	-0,02
	CL2	0,14	0,11	0,14	0,08	0,09	0,09	0,08	0,08	0,00	0,00	0,00	0,00	0,00	0,00	0,01	0,04	-0,02	-0,02	-0,02	-0,02
	CL3	0,14	0,11	0,14	0,08	0,09	0,09	0,08	0,08	0,00	0,00	0,00	0,00	0,00	0,00	0,01	0,04	-0,02	-0,02	-0,02	-0,02
	CL4	0,14	0,11	0,14	0,08	0,09	0,09	0,08	0,08	0,00	0,00	0,00	0,00	0,00	0,00	0,01	0,04	-0,02	-0,02	-0,02	-0,02
	CL5	0,14	0,11	0,14	0,08	0,09	0,09	0,08	0,08	0,00	0,00	0,00	0,00	0,00	0,00	0,01	0,04	-0,02	-0,02	-0,02	-0,02
	CL6	0,14	0,11	0,14	0,08	0,09	0,09	0,08	0,08	0,00	0,00	0,00	0,00	0,00	0,00	0,01	0,04	-0,02	-0,02	-0,02	-0,02
	GL1	0,13	0,10	0,13	0,08	0,08	0,08	0,08	0,08	-0,01	-0,01	-0,01	-0,01	-0,01	-0,01	0,00	0,04	-0,02	-0,02	-0,02	-0,02
	GL2	0,10	0,07	0,10	0,04	0,05	0,05	0,04	0,04	-0,04	-0,04	-0,04	-0,04	-0,04	-0,04	-0,04	0,00	-0,06	-0,06	-0,06	-0,06
	WT1	0,15	0,12	0,15	0,10	0,10	0,10	0,10	0,10	0,02	0,02	0,02	0,02	0,02	0,02	0,02	0,06	0,00	0,00	0,00	0,00
	WT2	0,15	0,12	0,15	0,10	0,10	0,10	0,10	0,10	0,02	0,02	0,02	0,02	0,02	0,02	0,02	0,06	0,00	0,00	0,00	0,00
	ST1	0,15	0,12	0,15	0,10	0,10	0,10	0,10	0,10	0,02	0,02	0,02	0,02	0,02	0,02	0,02	0,06	0,00	0,00	0,00	0,00
	OL1	0,15	0,12	0,15	0,10	0,10	0,10	0,10	0,10	0,02	0,02	0,02	0,02	0,02	0,02	0,02	0,06	0,00	0,00	0,00	0,00
OO1	0,15	0,12	0,15	0,10	0,10	0,10	0,10	0,10	0,02	0,02	0,02	0,02	0,02	0,02	0,02	0,06	0,00	0,00	0,00	0,00	
unit	tC/ha/year																				



6.1.3.3 Soil C Stock Data

Data for soils and soil emission factors is derived from measurements made from three data sets: Measurements made over the ICP Forests grid (1995 and 2005); Project Biosoil (1999); LUCAS soil assessment (2009).

Measurements were made in forest areas over the ICP Forest Sampling Grid in 1995 and repeated for the same plots in 2005. An additional project carried out in 1999 expanded the ICP Forests grid to agriculture and grassland plots. LUCAS was a project conducted by EUROSTAT that collected samples throughout Europe. Samples were collected in all sites at 0-20cm depth and some samples were collected also covering the 20-40cm. A summary of the number of plots is presented in Table 6-12.

Table 6-12: Number of sample plots per land-use and soil depth

No. Plots C(0-20cm) (measured)	Source				Total	No. Plots C(20-40cm) (measured)	Source				Total
	LUCAS	ICP/Biosoil					LUCAS	ICP/Biosoil			
Legenda KP	2009	1995/99	2005	Total		2009	1995/99	2005	Total		
01. Pinus pinaster	54	41	12	53	107	0	1	12	13	13	
02. Quercus suber	57	42	37	79	136	0	3	35	38	38	
03. Eucalyptus	46	21	8	29	75	0		8	8	8	
04. Quercus rotundifolia	30	25	23	48	78	0		21	21	21	
05. Other quercus	10	4	4	8	18	0		4	4	4	
06. Other broadleaves	5	19	17	36	41	0	1	17	18	18	
07. Pinus pinea + 08. Other coniferous	4	2	1	3	7	0	1	1	2	2	
09. Rain-fed crops	78	21		21	99	0	21		21	21	
10. Irrigated crops + 11. Rice	22	26		26	48	0	25		25	25	
12. Vineyards	22	14		14	36	0	14		14	14	
13. Olive	39	12		12	51	0	12		12	12	
14. Other permanent	11	11		11	22	0	11		11	11	
15. Grassland	42	18		18	60	0	15		15	15	
17. Settlements	7				7	0					
18. Shrubland	36	5	1	6	42	0	5	1	6	6	
Total	463	261	103	364	828	0	109	99	208	208	

Table 6-13: Average C Stock measured per land-use and soil depth

Average C (0-20cm) ton/ha (measured)	Source				Total Average	Average C (0-40cm) ton/ha (measured)	Source				
	LUCAS	ICP/Biosoil					LUCAS	ICP/Biosoil			
Legenda KP	2009	1995/99	2005	Average		20-40cm	0-20cm	20-40cm	0-40cm	40/20cm	
01. Pinus pinaster	70	73	72	72	71		77	45	122	59%	
02. Quercus suber	46	43	40	41	43		38	15	53	40%	
03. Eucalyptus	75	41	41	41	62		41	26	67	63%	
04. Quercus rotundifolia	41	43	45	44	43		44	15	59	35%	
05. Other quercus	58	51	52	52	55		52	39	91	74%	
06. Other broadleaves	71	66	63	64	65		60	45	105	75%	
07. Pinus pinea + 08. Other coniferous	74	25	64	38	58		46	28	74	62%	
09. Rain-fed crops	40	27		27	37		27	19	46	71%	
10. Irrigated crops + 11. Rice	39	39		39	39		37	28	65	74%	
12. Vineyards	36	24		24	31		24	16	40	69%	
13. Olive	49	33		33	45		33	20	53	61%	
14. Other permanent	44	26		26	35		26	16	42	61%	
15. Grassland	43	30		30	39		33	18	51	54%	
17. Settlements	55				55						
18. Shrubland	70	52	88	58	68		58	33	91	58%	
Média global	52	44	50	46	49		41	24	64	58%	
Grand Total							41	24	64	58%	

For all 208 plots for which both 0-20 cm and 20-40 cm was available the ratio of Carbon between the 2 depths was calculated and used to estimate the missing information for all the plots for which only 0-20 cm samples had been collected. Given the relatively low number of sampled plots and the lack of land-use history for each of these plots, this information was used only to characterize the average carbon stock in each land-use.

For the categories for which there is not enough data points (or there is no information at all), the following applied: for Flooded Areas (WT1) and Oceans (OO1) a zero C Stock was assumed; for Wetlands (WT2) the default IPCC 2006 Guidelines for Wetland Soils in Warm Temperate Climates (Vol 4; Chapter 2; Table 2.3) was used; for Other land (OL1) the default IPCC 2006 Guidelines for Sandy Soils in Warm Temperate Climates / average for Dry and Moist (Vol 4; Chapter 2; Table 2.3) was used.

The values used are presented in Table 6-14.

**Table 6-14: Average C Stock 0-40 cm per land-use**

Soil C Stock	
FL1	113,0
FL2	93,0
FL3	93,0
FL4	98,0
FL5	66,0
FL6	65,0
FL7	89,0
FL8	107,0
CL1	59,0
CL2	64,0
CL3	64,0
CL4	51,0
CL5	71,0
CL6	56,0
GL1	61,0
GL2	107,0
WT1	0,0
WT2	88,0
ST1	87,0
OL1	27,0
OO1	0,0
unit	tC/ha

Soil emission/sequestration factors were then calculated for all possible land-use changes considering the changes in average C Stocks for each land-use, as contained in Table 6-14, and a 20 year conversion period, as shown in Equation 6-9.

Equation 6-9: Estimation of Soil Emission Factors

$$SEF_{x \rightarrow y} = \frac{ASC_y - ASC_x}{20}$$

Where:

$SEF_{x \rightarrow y}$ = Soil Emission Factor for Land-use Change from x to y (tC/ha/year)

ASC_y = Average Soil Carbon Stock in Land Use y (tC/ha)

ASC_x = Average Soil Carbon Stock in Land Use x (tC/ha)

The resulting Soil Emission Factors are presented in Table 6-15.



Table 6-15: Annual Emission/Sequestration Factors for Soil

Soil EF	to																				
	FL1	FL2	FL3	FL4	FL5	FL6	FL7	FL8	CL1	CL2	CL3	CL4	CL5	CL6	GL1	GL2	WT1	WT2	ST1	OL1	OO1
FL1	0,00	-1,00	-1,00	-0,75	-2,35	-2,40	-1,20	-0,30	-2,70	-2,45	-2,45	-3,10	-2,10	-2,85	-2,60	-0,30	-5,65	-1,25	-1,30	-4,30	-5,65
FL2	1,00	0,00	0,00	0,25	-1,35	-1,40	-0,20	0,70	-1,70	-1,45	-1,45	-2,10	-1,10	-1,85	-1,60	0,70	-4,65	-0,25	-0,30	-3,30	-4,65
FL3	1,00	0,00	0,00	0,25	-1,35	-1,40	-0,20	0,70	-1,70	-1,45	-1,45	-2,10	-1,10	-1,85	-1,60	0,70	-4,65	-0,25	-0,30	-3,30	-4,65
FL4	0,75	-0,25	-0,25	0,00	-1,60	-1,65	-0,45	0,45	-1,95	-1,70	-1,70	-2,35	-1,35	-2,10	-1,85	0,45	-4,90	-0,50	-0,55	-3,55	-4,90
FL5	2,35	1,35	1,35	1,60	0,00	-0,05	1,15	2,05	-0,35	-0,10	-0,10	-0,75	0,25	-0,50	-0,25	2,05	-3,30	1,10	1,05	-1,95	-3,30
FL6	2,40	1,40	1,40	1,65	0,05	0,00	1,20	2,10	-0,30	-0,05	-0,05	-0,70	0,30	-0,45	-0,20	2,10	-3,25	1,15	1,10	-1,90	-3,25
FL7	1,20	0,20	0,20	0,45	-1,15	-1,20	0,00	0,90	-1,50	-1,25	-1,25	-1,90	-0,90	-1,65	-1,40	0,90	-4,45	-0,05	-0,10	-3,10	-4,45
FL8	0,30	-0,70	-0,70	-0,45	-2,05	-2,10	-0,90	0,00	-2,40	-2,15	-2,15	-2,80	-1,80	-2,55	-2,30	0,00	-5,35	-0,95	-1,00	-4,00	-5,35
CL1	2,70	1,70	1,70	1,95	0,35	0,30	1,50	2,40	0,00	0,25	0,25	-0,40	0,60	-0,15	0,10	2,40	-2,95	1,45	1,40	-1,60	-2,95
CL2	2,45	1,45	1,45	1,70	0,10	0,05	1,25	2,15	-0,25	0,00	0,00	-0,65	0,35	-0,40	-0,15	2,15	-3,20	1,20	1,15	-1,85	-3,20
CL3	2,45	1,45	1,45	1,70	0,10	0,05	1,25	2,15	-0,25	0,00	0,00	-0,65	0,35	-0,40	-0,15	2,15	-3,20	1,20	1,15	-1,85	-3,20
CL4	3,10	2,10	2,10	2,35	0,75	0,70	1,90	2,80	0,40	0,65	0,65	0,00	1,00	0,25	0,50	2,80	-2,55	1,85	1,80	-1,20	-2,55
CL5	2,10	1,10	1,10	1,35	-0,25	-0,30	0,90	1,80	-0,60	-0,35	-0,35	-1,00	0,00	-0,75	-0,50	1,80	-3,55	0,85	0,80	-2,20	-3,55
CL6	2,85	1,85	1,85	2,10	0,50	0,45	1,65	2,55	0,15	0,40	0,40	-0,25	0,75	0,00	0,25	2,55	-2,80	1,60	1,55	-1,45	-2,80
GL1	2,60	1,60	1,60	1,85	0,25	0,20	1,40	2,30	-0,10	0,15	0,15	-0,50	0,50	-0,25	0,00	2,30	-3,05	1,35	1,30	-1,70	-3,05
GL2	0,30	-0,70	-0,70	-0,45	-2,05	-2,10	-0,90	0,00	-2,40	-2,15	-2,15	-2,80	-1,80	-2,55	-2,30	0,00	-5,35	-0,95	-1,00	-4,00	-5,35
WT1	5,65	4,65	4,65	4,90	3,30	3,25	4,45	5,35	2,95	3,20	3,20	2,55	3,55	2,80	3,05	5,35	0,00	4,40	4,35	1,35	0,00
WT2	1,25	0,25	0,25	0,50	-1,10	-1,15	0,05	0,95	-1,45	-1,20	-1,20	-1,85	-0,85	-1,60	-1,35	0,95	-4,40	0,00	-0,05	-3,05	-4,40
ST1	1,30	0,30	0,30	0,55	-1,05	-1,10	0,10	1,00	-1,40	-1,15	-1,15	-1,80	-0,80	-1,55	-1,30	1,00	-4,35	0,05	0,00	-3,00	-4,35
OL1	4,30	3,30	3,30	3,55	1,95	1,90	3,10	4,00	1,60	1,85	1,85	1,20	2,20	1,45	1,70	4,00	-1,35	3,05	3,00	0,00	-1,35
OO1	5,65	4,65	4,65	4,90	3,30	3,25	4,45	5,35	2,95	3,20	3,20	2,55	3,55	2,80	3,05	5,35	0,00	4,40	4,35	1,35	0,00

unit tC/ha/year

6.1.3.4 Other Dead Organic Matter

Dead organic matter (other than litter) is considered to be “included elsewhere”.

The two main sources for dead wood are harvesting residues (included and reported as losses in living biomass, that include the emission of the whole tree) and dead trees from fire (included and reported as indirect emissions from fire, that include the emission of the whole tree). Other dead wood sources are considered negligible compared to these two sources or included in harvesting and are not reported separately.



6.2 Forest Land (CFR 4.A)

The areas of forest land have increased since 1990, but have stabilized over the last decade. Considering only the scope of CRF Table 4.A emissions and removals, forest land was responsible for an average net-sequestration of -5.58 MtCO_{2eq} in the period 1990-2021, and a value of -4.86 MtCO_{2eq} in 2021. Considering also the effect of other emission sources, most notably CRF 4(V) biomass burning, these values are significantly reduced to an average net-sequestration was -2.84 MtCO_{2eq} in the period 1990-2021, and -2.24 MtCO_{2eq} in 2021.

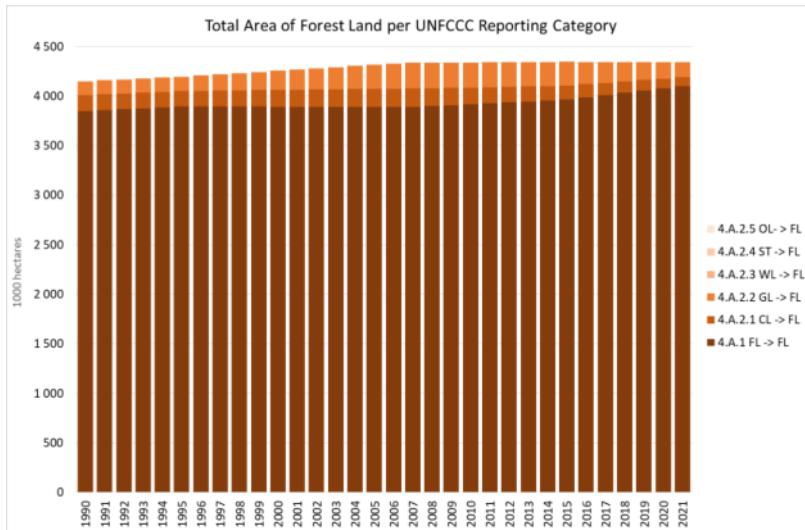

Figure 6-15: Areas of Forest Land per UNFCCC Reporting Category

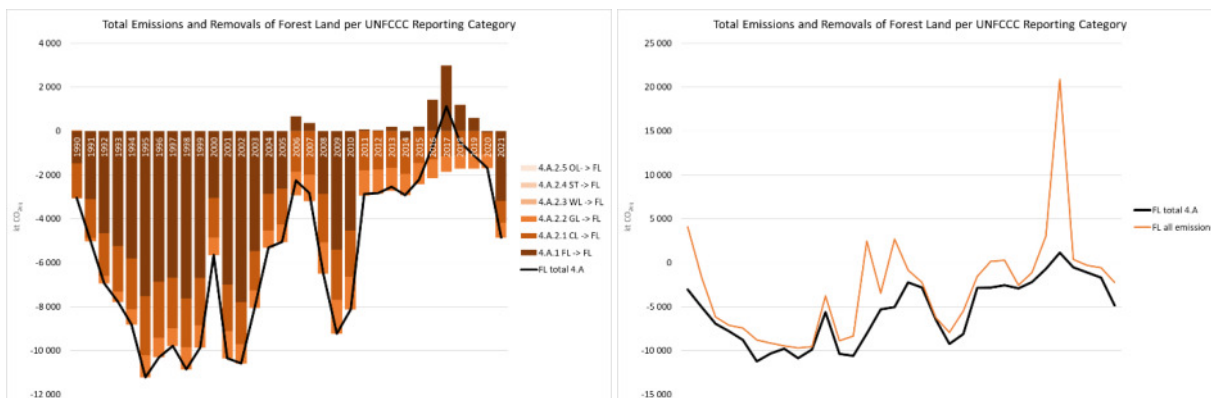

Figure 6-16: Total Emissions and Removals in Forest Land

6.2.1 Forest Land Remaining Forest Land

6.2.1.1 Area

Area estimates for Forest Land Remaining Forest Land were made following the methodology outlined in section 6.1.2 Representation of Land-Areas and Land-Use Changes.

Land-use changes between different forest types (conversion of one type of forest into another or changes in dominant species in mixed forests) have been estimated and included in this category.

6.2.1.2 Living Biomass

6.2.1.2.1 Gains in Living Biomass

Gains in living biomass refer to trees only and were estimated using Equation 6-10. Estimates were made for each forest type (8 forest types considered; see Table 6-1).

**Equation 6-10: Estimation of Above Ground Biomass Gains in Forest Land Remaining Forest Land**

$$AGBG_{RY_i} = \sum_{FT_f} AFF_{f,RY_i} \times MAI_f \times BCEF_f \times CF_f$$

Equation 6-11: Estimation of Below Ground Biomass Gains in Forest Land Remaining Forest Land

$$BGBG_{RY_i} = \sum_{FT_f} AFF_{f,RY_i} \times MAI_f \times BCEF_f \times RTS_f \times CF_f$$

Where:

$AGBG_{RY_i}$ = Above Ground Biomass Gains in Reporting Year i

$BGBG_{RY_i}$ = BelowGround Biomass Gains in Reporting Year i

\sum_{FT_f} = Sum for all forest types

AFF_{f,RY_i} = Area of forest land remaining forest land of type f in reporting year i

MAI_f = Mean Annual Increment of forest species f

$BCEF_f$ = Biomass Conversion and Expansion Factor of forest species f

RTS_y = Root-to-Shoot Factor of forest species f

CF_y = Carbon Fraction of forest species f

Gains in living biomass from understory vegetation (non-tree woody vegetation, grasses, ferns, mosses) were not estimated. It is assumed that gains and losses in this vegetation type are equivalent or that any gains or losses are marginal compared to the estimates from trees. This assumption is considered conservative given the annual vegetation cycles (for annual species gains and losses should be equivalent) and management practices (shrub biomass is reduced as a fire management practice, and removals from lands with growing vegetation tend to offset emissions from lands under shrub vegetation control).

6.2.1.2.2 Losses in Living Biomass

Losses of living biomass were categorised in different types / origins of loss and the corresponding emissions are estimated using different approaches according to loss type. Table 6.23 provides a summary of the types of losses considered in the reporting and how they were allocated to UNFCCC Categories “forest land remaining forest land” and “land converted to forest”.

**Table 6-16: Summary of types of losses in living biomass considered in the estimations of emissions and removals in forest land**

Type of C loss	Definition / data sources	Allocation L->FL and FL<->FL
Industrial harvest	Industry wood consumption; estimates include the loss of biomass from the entire tree (AG and BG biomass) at the year of harvest Source: UNECE-FAO database; Regional Forest Authorities	Allocated according to total carbon stock in each land-use transition
Salvaged wood from forest fires	It is assumed that all salvaged wood is included in “industrial harvest”	NA
Forest conversion	Losses from converting one forest type into another forest type (change in dominant species); estimated based on loss of standing volume of previous forest type; estimates include the loss of biomass from the entire tree (AG and BG biomass) at the year of conversion Source: COS (for areas) and NFI/calculated for average carbon stock in each land-use conversion	L->FL = not applicable FL<->FL = based on land-use change areas in reporting year
Conversion to forest (afforestation)	Losses from converting a non-forest land-use type into a forest type; estimated based on loss of living biomass of previous land-use type Source: COS (for areas) and please refer to the descriptions in other land-uses for average carbon stocks lost	L->FL = allocation based on area per previous land-use per new forest type FL->FL = not applicable
Other Wood Use	Wood uses for un-declared purposes (small industry or households) and non-industrial thinning; estimates include the loss of biomass from the entire tree (AG and BG biomass) at the year of harvest Source: Calculated	Allocated according to total carbon stock in each land-use transition
Natural mortality (non-fire related)	It is assumed that all natural mortality is included in “Other Wood Use”	NA
Non-salvaged wood	Wood lost as a result of forest fires that was not salvaged for industrial use; estimates include the loss of biomass from the entire tree (AG and BG biomass) at the year of fire Source: calculated per forest species as total loss of wood – industrial wood consumption (zero when industrial wood > total wood loss due to fires)	<u>Reported as “fire emissions” not as “losses”</u> L->FL = allocation based on area per forest type FL->FL = allocation based on area per forest type
Deforestation	Losses from converting one forest type into another land-use; estimated based on loss of average living biomass carbon stock of the previous forest type; estimates include the loss of biomass from the entire tree (AG and BG biomass) at the year of deforestation Source: COS (for areas) and NFI/calculation for average carbon stocks	<u>Reported as “losses” from FL->L in the respective land-use and not as Forest land emissions</u>

Losses in living biomass refer to harvesting and conversion between different forest types. Additional losses in living biomass due to forest fires are reported in CRF Table 4(V).

Emissions from industrial harvesting were estimated from domestic industrial wood consumption statistics as contained in the UNECE/FAO TIMBER database⁵. Data from the Timber Database is available for hardwoods and conifers only. Data from the Azores and Madeira is available by species and was allocated to the respective forest type. The remaining hardwoods volume is fully allocated to FL4 “Eucalyptus” and the remaining softwoods volume is fully allocated to FL1 “Maritime pine”, as these are the main tree species used by industry in Portugal.

⁵ Database containing data of domestic production, imports and exports of wood removals and forest products, data refers to 1964-2020, last updated in August 2021

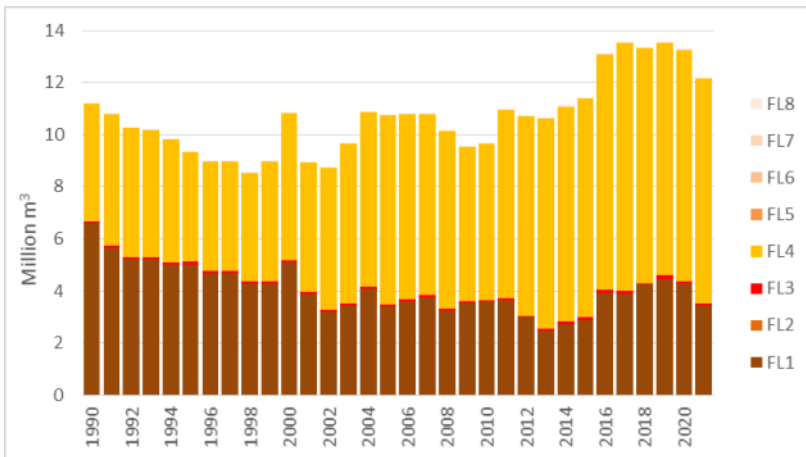

Figure 6-17: Industrial Harvest per Forest Type

Emissions from salvaged wood are considered included in industrial harvesting. Emissions from non-salvaged wood (i.e. additional wood losses to those already included in industrial harvesting) are included as fire emissions in CRF.4(V).

Emissions from forest conversion are associated with changes in species, which may happen following final felling followed by a reforestation using a different species or by more subtle changes in dominant species (which lead to a change in forest type classification). Forest conversions are not deforestation (because a forest type is followed by another forest type), but the emissions from conversion are calculated in a similar manner as deforestation, i.e., it consists on the emission of all the living biomass carbon present in the previous forest type.

Emissions from conversions to forest (i.e. land converted to forest or afforestation) include the emissions related to the loss of carbon present in the previous land-use.

Finally emissions from natural mortality are considered to be included in “other wood use”.

There are no statistics for harvesting for other wood use (domestic use of biomass for energy, thinning with no industrial use). The volumes associated with this harvesting were numerically adjusted so that changes in total stocks in the NFI match sum of gains and losses in the equivalent period. This additional harvesting is considered constant in each period between NFI (1989-1995; 1996-2005; 2006-2015). The value for 2016 onwards can only be calculated once a new NFI becomes available. Until then, the average for the entire time period 1990-2015 per forest type is being considered.

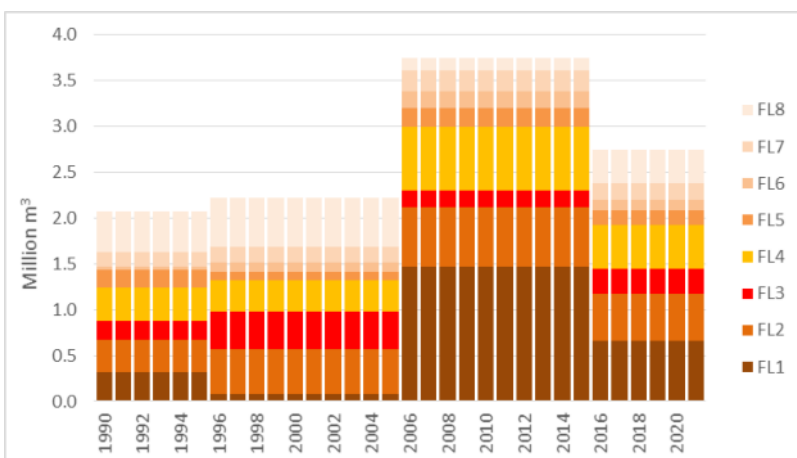

Figure 6-18: Other Wood Use per Forest Type



Losses in living biomass from understory vegetation (non-tree woody vegetation, grasses, ferns, mosses) are not estimated. It is assumed that gains and losses in this vegetation type are equivalent or that any gains or losses have a marginal influence in the final estimates. This assumption is considered conservative given the annual vegetation cycles (for annual species gains and losses should be equivalent) and management practices (shrubs biomass is reduced as a fire management practice, and removals from lands with growing vegetation tend to offset emissions from lands under shrub vegetation control).

Equation 6-12: Estimation of losses in living biomass in Forest Land Remaining Forest Land

$$LBL_{RY_i} = LBLH_{RY_i} + LBLOWU_{RY_i} + LBLFC_{RY_i}$$

$$LBLH_{RY_i} = \sum_{FS_y} (HARV_{y,RY_i} \times BEF_y \times (1 + RTS_y) \times CF_y)$$

$$LBLOWU_{RY_i} = \sum_{FS_y} (OWU_{y,RY_i} \times BEF_y \times (1 + RTS_y) \times CF_y)$$

$$LBLFC_{RY_i} = \sum_{f \rightarrow x} AFC_{f \rightarrow x,RY_i} \times (AGB_f + BGB_f)$$

Where:

LBL_{RY_i} = Living Biomass Losses in Reporting Year i (tC)

$LBLH_{RY_i}$ = Living Biomass Losses from Industrial Harvesting in Reporting Year i (tC)

$LBLOWU_{RY_i}$ = Living Biomass Losses from Other Wood Use in Reporting Year i (tC)

$LBLFC_{RY_i}$ = Living Biomass Losses from Forest Conversion in Reporting Year i (tC)

\sum_{FS_y} = Sum for all forest species

$\sum_{f \rightarrow x}$ = Sum for all conversions between forest types

$HARV_{y,RY_i}$ = Volume of industrial harvesting of forest species y in reporting year i (m³)

OWU_{y,RY_i} = Volume of other wood use harvesting of forest species y in reporting year i (m³)

$AFC_{f \rightarrow x,RY_i}$ = Area of forest land type f converted into type x in reporting year i (ha)

AGB_f = Average Above Ground Biomass of forest type f

BGB_f = Average Below Ground Biomass of forest type f

$BCEF_y$ = Biomass Conversion and Expansion Factor of forest species y

RTS_y = Root-to-Shoot Factor of forest species y

CF_y = Carbon Fraction of forest species y

6.2.1.3 Dead Organic Matter

The annual emission/sequestration factors of Table 6-11 combined with the relevant area estimates were used to estimate emissions and removals in this pool.



6.2.1.4 Mineral Soils

The annual emission/sequestration factors of Table 6-15 combined with the relevant area estimates were used to estimate emissions and removals in this pool.

6.2.2 Land Converted to Forest

6.2.2.1 Area

Area estimates for Land Converted to Forest Land were made following the methodology outlined in section 6.1.2 Representation of Land-Areas and Land-Use Changes.

6.2.2.2 Living Biomass

6.2.2.2.1 Gains in Living Biomass

Equation 6-10 and Equation 6-11 was also used to estimate gains in living biomass for Land converted to Forests, the only difference being the area estimates, which should now refer to “Area converted to forest land of type f in reporting year i”. The remaining parameters were kept unchanged for the two reporting categories.

6.2.2.2.2 Losses in Living Biomass

Losses in living biomass in Land Converted to Forest were estimated as the sum of emissions from industrial harvesting and other wood use, and emissions from the elimination of the vegetation of the former land use.

The industrial harvesting under lands converted to forest was estimated based on the total carbon stock share of the area of “land converted to FLx” and the total carbon stock of the “total FLx area” in the respective year; the remaining industrial wood consumption was assumed to come from forest land remaining forest land. A similar approach was used for allocating “other wood use” to “land converted to FLx”.

6.2.2.3 Dead Organic matter

The annual emission/sequestration factors of Table 6-10 combined with the relevant area estimates were used to estimate emissions and removals in this pool.

6.2.2.4 Mineral Soils

The annual emission/sequestration factors of Table 6-15 combined with the relevant area estimates were used to estimate emissions and removals in this pool.



6.3 Cropland (CRF 4.B)

The areas of cropland have been reduced since 1990, mostly for conversion to grasslands, forest land and other land. However, this was accompanied by a significant trend towards the expansion of the areas of permanent crops (conversion from non cropland uses, but also replacing other crops) and this is the main driver for the observed average net-sink.

Considering only the scope of CRF Table 4.B emissions and removals, cropland was responsible for an average net-sequestration of -1.39 MtCO_{2eq} in the period 1990-2021, and a value of -1.95 MtCO_{2eq} in 2021. Considering also the effect of other emission sources (most notably CRF 4.(V) biomass burning), these values are significantly reduced to an average net-sequestration was -1.01 MtCO_{2eq} in the period 1990-2021, and -1.58 MtCO_{2eq} in 2021.

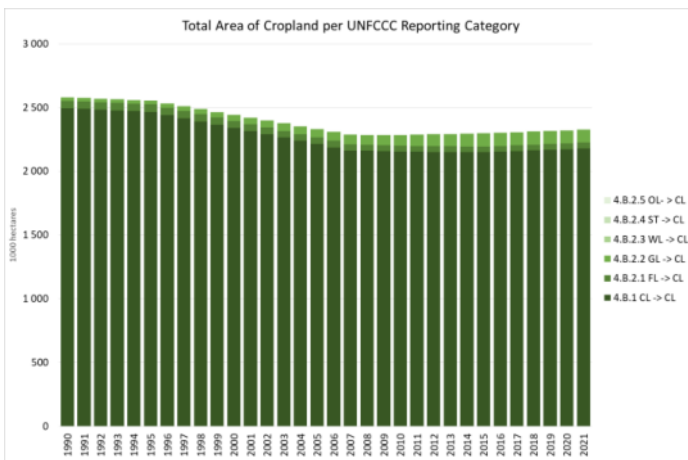

Figure 6-19: Areas of Cropland per UNFCCC Reporting Category

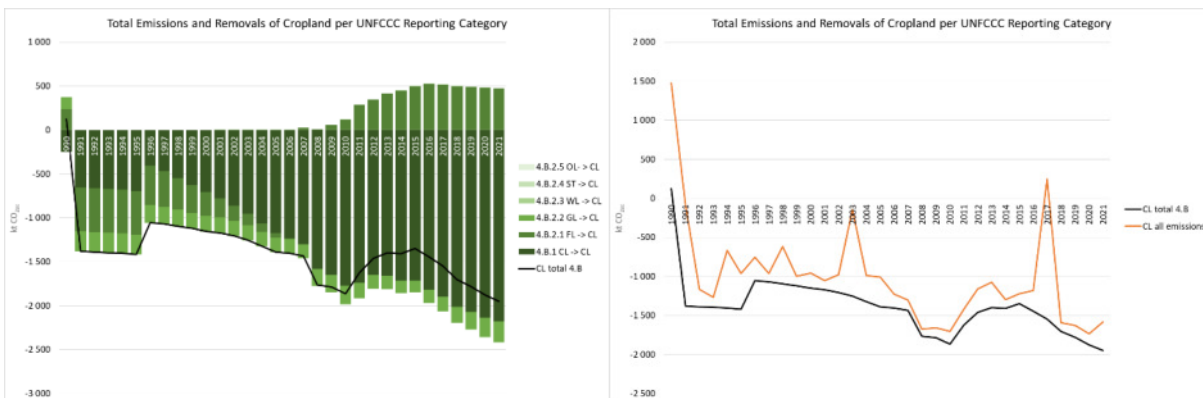

Figure 6-20: Total Emissions and Removals in Cropland

6.3.1 Cropland Remaining Cropland

6.3.1.1 Area

Area estimates for Cropland Remaining Cropland were made following the methodology outlined in section 6.1.2 Representation of Land-Areas and Land-Use Changes.

Land-use changes between different cropland types (conversion of one type of cropland into another) have been estimated and included in this category.



6.3.1.2 Living Biomass

6.3.1.2.1 Gains in Living Biomass

The default assumption of no net-changes in living biomass was used for all cropland categories in that category for over 20 years.

Gains in living biomass in cropland remaining cropland result from

- the conversion between cropland types, in particular conversion to perennial crops (vineyards, olive groves, other permanent crops), and
- the post-fire recovery of burnt permanent crop areas⁶

The both cases the estimations are made using unit values presented in section 6.1.3.1.2 Permanent Crops (CL4-CL6) multiplied by the relevant areas. All gains are assumed to occur in the year when the land-use change occurs (for annual crops) and over a 20 years period (for perennial crops).

6.3.1.2.2 Losses in Living Biomass

The same default assumption of no net-changes for all cropland categories in that category for over 20 years was applied to losses in living biomass was used. Therefore, losses in living biomass in cropland remaining cropland result only from the conversion between cropland types, in particular conversion from perennial crops (vineyards, olive groves, other permanent crops) to annual crops. All losses are assumed to occur in the year when the land use change occurs. Losses from fires are reported as fire emissions in CRF 4(V).

6.3.1.3 Dead Organic matter

The annual emission/sequestration factors of Table 6-10 combined with the relevant area estimates were used to estimate emissions and removals in this pool.

6.3.1.4 Mineral Soils

The annual emission/sequestration factors of Table 6-15 combined with the relevant area estimates were used to estimate emissions and removals in this pool.

6.3.2 Land Converted to Cropland

6.3.2.1 Area

Area estimates for Land Converted to Cropland were made following the methodology outlined in section 6.1.2 Representation of Land-Areas and Land-Use Changes.

6.3.2.2 Living Biomass

6.3.2.2.1 Gains in Living Biomass

Gains in living biomass in land converted to cropland result in particular from the conversion to perennial crops (vineyards, olive groves, other permanent crops), according to the unit values and transition periods presented in section 6.1.3.1.2 Permanent Crops (CL4-CL6). All gains are assumed to occur in the year when the land-use change occurs (for annual crops) or over a 20 years period (for perennial crops).

⁶ Fire emissions in CRF.4(V) assume the loss of the full carbon stock of permanent crops in affected areas. The assumption is that, if no land-use change occurs after the fire, this is followed by replanting of the burnt areas with the same species.



6.3.2.2.2 Losses in Living Biomass

Losses in living biomass in land converted to cropland result from the loss of the vegetation of the previous land use. All losses are assumed to occur in the year when the land use change occurs. Losses from fires are reported as fire emissions in CRF 4(V).

6.3.2.3 Dead Organic matter

The annual emission/sequestration factors of Table 6-10 combined with the relevant area estimates were used to estimate emissions and removals in this pool.

6.3.2.4 Mineral Soils

The annual emission/sequestration factors of Table 6-15 combined with the relevant area estimates were used to estimate emissions and removals in this pool.



6.4 Grassland (CRF 4.C)

Grassland areas have decreased since 1990. The conversion from agriculture to grasslands usually results in an increased sequestration, while the conversions from forest land result in increased emissions.

Considering only the scope of CRF Table 4.C emissions and removals, cropland was responsible for an average net-sequestration of $-1.64 \text{ MtCO}_{2\text{eq}}$ in the period 1990-2020, and a value of $-3.56 \text{ MtCO}_{2\text{eq}}$ in 2021. Considering also the effect of other emission sources (most notably CRF 4.(V) Biomass burning), these values are significantly reduced to an average net-sequestration was $-0.37 \text{ MtCO}_{2\text{eq}}$ in the period 1990-2021, and $-2.82 \text{ MtCO}_{2\text{eq}}$ in 2021.

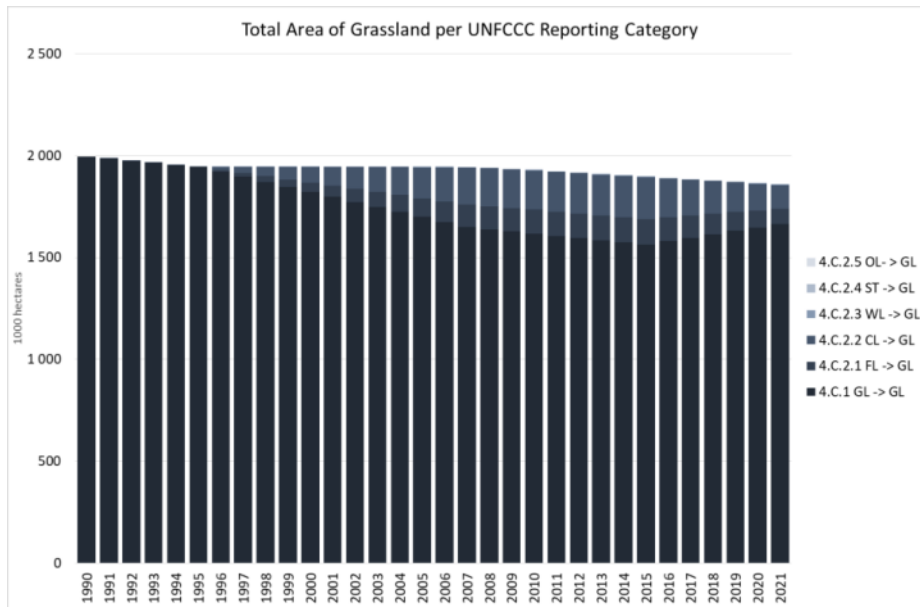

Figure 6-21: Areas of Grassland per Reporting Category (1000 ha)

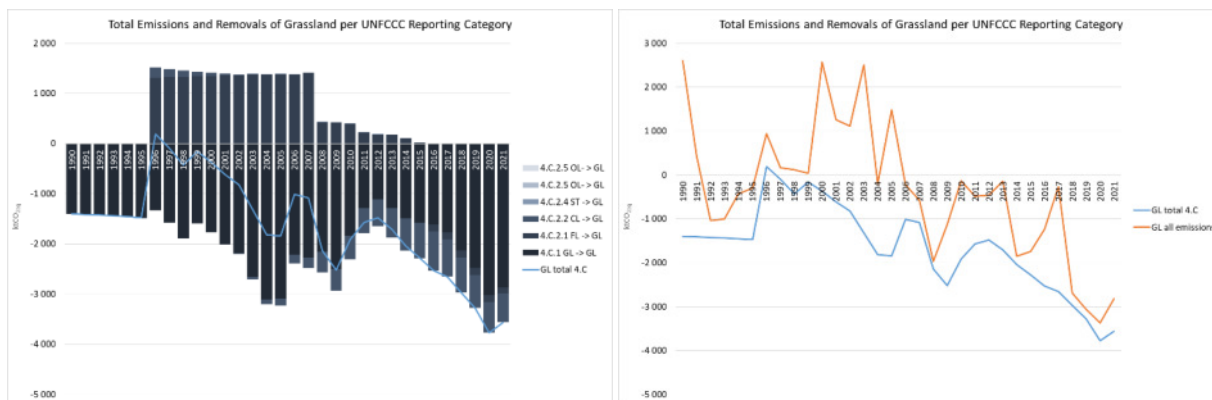

Figure 6-22: Total Emissions and Removals in Grassland

6.4.1 Grassland Remaining Grassland

6.4.1.1 Area

Area estimates for Grassland Remaining Grassland were made following the methodology outlined in section 6.1.2 Representation of Land-Areas and Land-Use Changes.



6.4.1.2 Living Biomass

6.4.1.2.1 Gains in Living Biomass

The default assumption of no net-changes in living biomass was used for all grassland categories in that category for over 20 years.

Gains in living biomass in grassland remaining grassland result from:

- the conversion between grassland types, in particular conversion to shrublands, and
- the post-fire recovery of burnt shrublands⁷

The both cases the estimations are made using unit values presented in section 6.1.3.1.3 Shrublands (GL2) multiplied by the relevant areas. All gains are assumed to occur in the year when the land-use change occurs (for pastures) and over a 20 years period (for shrublands).

6.4.1.2.2 Losses in Living Biomass

The same default assumption of no net-changes for all grassland categories in that category for over 20 years was applied to losses in living biomass was used. Therefore, losses in living biomass in grassland remaining grassland result only from the conversion between grassland types, in particular conversion from Shrublands to pastures. All losses are assumed to occur in the year when the land use change occurs. Losses from fires are reported as fire emissions in CRF 4(V).

6.4.1.3 Dead Organic matter

The annual emission/sequestration factors of Table 6-10 combined with the relevant area estimates were used to estimate emissions and removals in this pool.

6.4.1.4 Mineral Soils

The annual emission/sequestration factors of Table 6-15 combined with the relevant area estimates were used to estimate emissions and removals in this pool.

6.4.2 Land Converted to Grassland

6.4.2.1 Area

Area estimates for Land Converted to Grassland were made following the methodology outlined in section 6.1.2 Representation of Land-Areas and Land-Use Changes.

6.4.2.2 Living Biomass

6.4.2.2.1 Gains in Living Biomass

Gains in living biomass in land converted to grassland result from the accumulation of grassland vegetation, according to the unit value presented in Table 6.16. All gains are assumed to occur in the year when the land-use change occurs.

Gains in living biomass in land converted to grassland result in particular from the conversion to Shrublands, according to the unit values and transition periods presented in section 6.1.3.1.3 Shrublands (GL2). All gains are assumed to occur in the year when the land-use change occurs (for GL1 pastures) or over a 20 years period (for GL2 shrublands).

⁷ Fire emissions in CRF.4(V) assume the loss of the full carbon stock of shrublands in affected areas. The assumption is that, if no land-use change occurs after the fire, this is followed by natural recovery of the burnt areas with the same species.



6.4.2.2.2 Losses in Living Biomass

Losses in living biomass in land converted to grassland result from the loss of the vegetation of the previous land use. All losses are assumed to occur in the year when the land use change occurs. Losses from fires are reported as fire emissions in CRF 4(V).

6.4.2.3 Dead Organic matter

The annual emission/sequestration factors of Table 6-10 combined with the relevant area estimates were used to estimate emissions and removals in this pool.

6.4.2.4 Mineral Soils

The annual emission/sequestration factors of Table 6-15 combined with the relevant area estimates were used to estimate emissions and removals in this pool.



6.5 Wetlands (CRF 4.D)

The area of wetlands has been increasing over time, mostly due to the construction of artificial reservoirs, which are included in this land use category. An on-going programme to increase the water storage and hydro-electricity production capacity will likely maintain this trend in the future. As expected under these trends, wetlands are a net-source of emissions, although not a very significant one.

Considering only the scope of CRF Table 4.D emissions and removals, wetlands were responsible for an average net-emission of 0.52 MtCO_{2eq} in the period 1990-2021, and a value of 0.37 MtCO_{2eq} in 2021. Considering also the effect of other emission sources (most notably CRF 4.(III) N₂O from soil carbon loss), these values are slightly increased to an average net-emission of 0.55 MtCO_{2eq} in the period 1990-2021, and 0.39 MtCO_{2eq} in 2021.

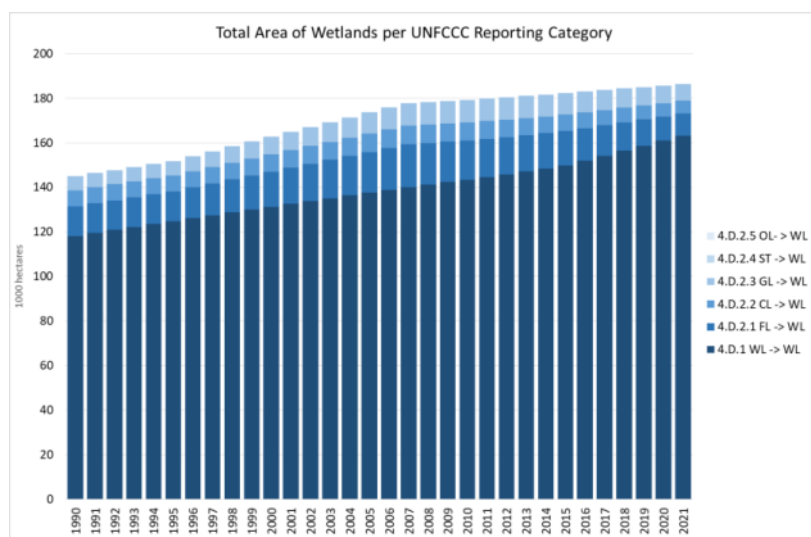

Figure 6-23: Areas of Wetlands per Reporting Category (1000 ha)

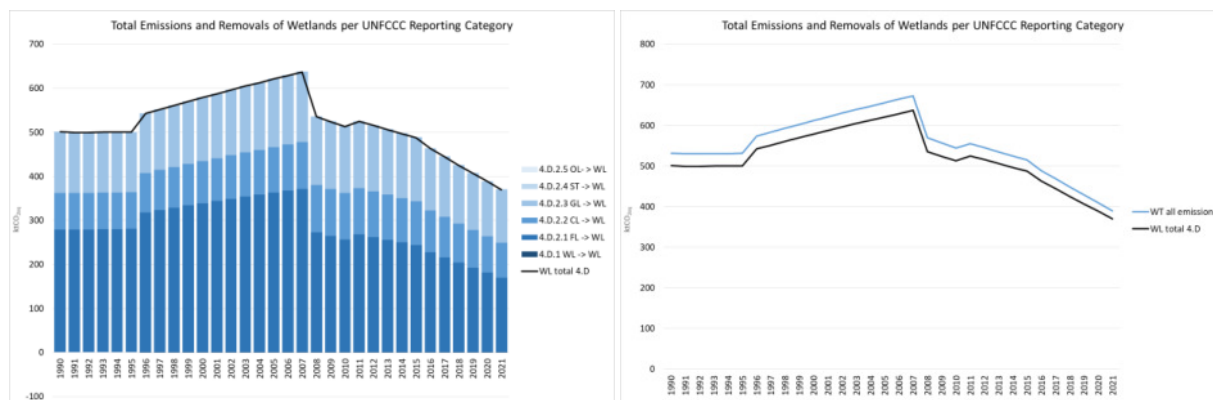

Figure 6-24: Total Emissions and Removals in Wetlands (kt CO_{2e})

6.5.1 Wetlands remaining wetlands

Area estimates for Wetlands Remaining Wetlands were made following the methodology outlined in section 6.1.2 Representation of Land-Areas and Land-Use Changes.

The default assumption of no net-changes was used for all pools in wetlands remaining wetlands in that category for over 20 years. Therefore, all gains and losses in wetlands remaining wetlands were considered zero.



6.5.2 Lands converted to wetlands

6.5.2.1 Area

Area estimates for Land Converted to Wetlands were made following the methodology outlined in section 6.1.2 Representation of Land-Areas and Land-Use Changes.

6.5.2.2 Living Biomass

6.5.2.2.1 Gains in Living Biomass

Gains in living biomass are estimated to be zero in WT1 “flooded areas” and are estimated for conversions to WT2 “wetlands”, according to the unit value presented 6.1.3.1.4 Annual Crops (CL1-CL3), Pastures (GL1) and Wetlands (WT2). All gains are assumed to occur over a 20 year period.

6.5.2.2.2 Losses in Living Biomass

Losses in living biomass in land converted to wetlands result from the loss of the vegetation of the previous land use. All losses are assumed to occur in the year when the land use change occurs.

6.5.2.3 Dead Organic matter

The annual emission/sequestration factors of Table 6-10 combined with the relevant area estimates were used to estimate emissions and removals in this pool.

6.5.2.4 Mineral Soils

The annual emission/sequestration factors of Table 6-15 combined with the relevant area estimates were used to estimate emissions and removals in this pool.



6.6 Settlements (CFR 4.E)

Over the past decades Portugal has witnessed an enormous growth in the building of infrastructure and urban expansion. As a consequence the areas under settlements have increased since 1990. As expected under these trends, settlements are a net-source of emissions, although not a very significant one.

Considering only the scope of CRF Table 4.E emissions and removals, settlements were responsible for an average net-emission of 0.26 MtCO_{2eq} in the period 1990-2020, and a value of 0.10 MtCO_{2eq} in 2020. Considering also the effect of other emission sources, these values are slightly increased to an average net-emission of 0.27 MtCO_{2eq} in the period 1990-2020, and 0.11 MtCO_{2eq} in 2020.

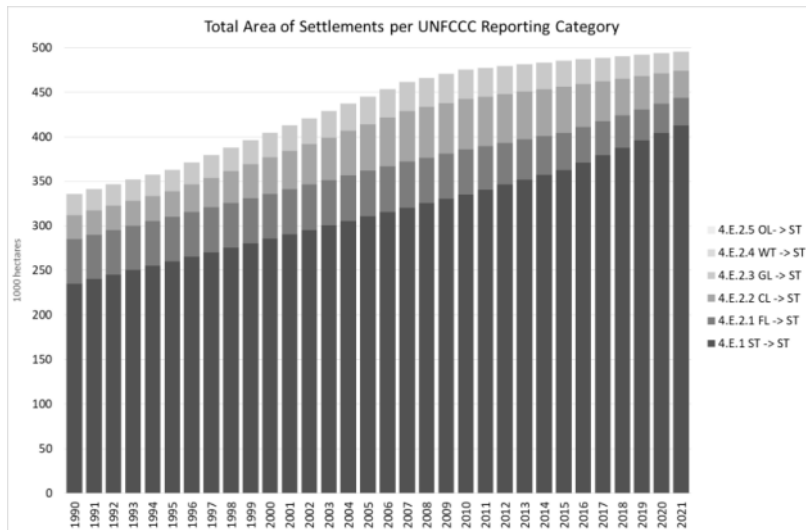

Figure 6-25: Areas of Settlements per Reporting Category

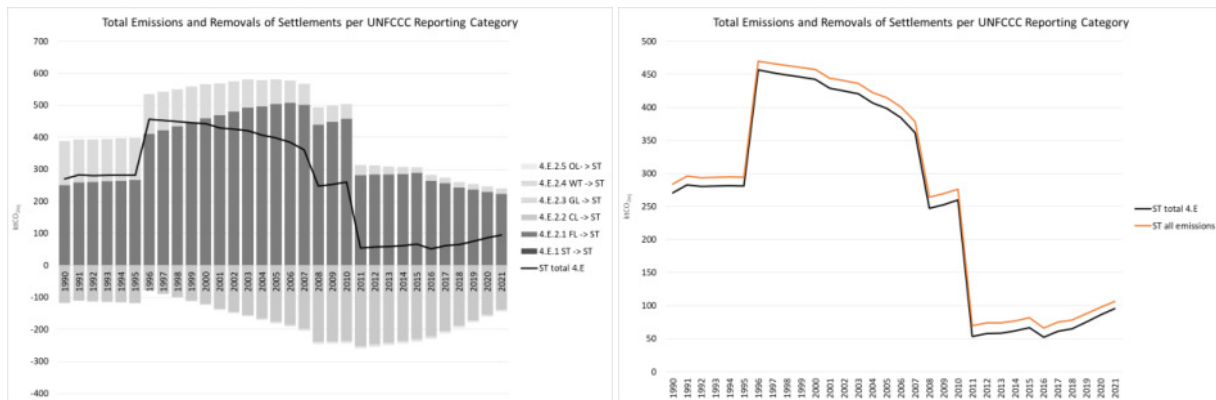

Figure 6-26: Total Emissions and Removals in Settlements

6.6.1 Settlements remaining settlements

Area estimates for Settlements Remaining Settlements were made following the methodology outlined in section 6.1.2 Representation of Land-Areas and Land-Use Changes.

The default assumption of no net-changes was used for all pools in settlements in that category for over 20 years. Therefore, all gains and losses in settlements remaining settlements were considered zero.



6.6.2 Lands converted to settlements

6.6.2.1 Area

Area estimates for Land Converted to Settlements were made following the methodology outlined in section 6.1.2 Representation of Land-Areas and Land-Use Changes.

6.6.2.2 Living Biomass

6.6.2.2.1 Gains in Living Biomass

Gains in living biomass are estimated to be zero.

6.6.2.2.2 Losses in Living Biomass

Losses in living biomass in land converted to settlements result from the loss of the vegetation of the previous land use. All losses are assumed to occur in the year when the land use change occurs.

6.6.2.3 Dead Organic matter

The annual emission/sequestration factors of Table 6-10 combined with the relevant area estimates were used to estimate emissions and removals in this pool.

6.6.2.4 Mineral Soils

The annual emission/sequestration factors of Table 6-15 combined with the relevant area estimates were used to estimate emissions and removals in this pool.



6.7 Other Land (CRF 4.F)

The category other land is a residual land-use class with little expression in national area totals.

Since there are no reported conversion to “other land” and we assume stabilised carbon stocks in lands over 20 years, the emissions from this category are assumed to be zero.

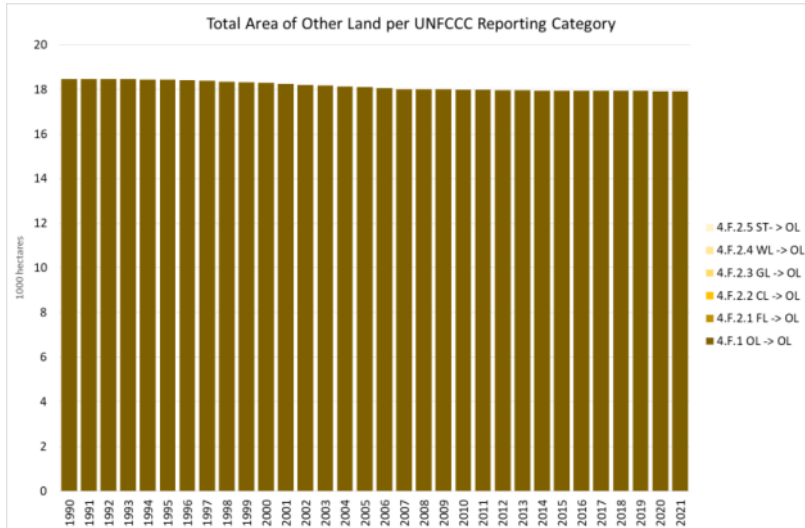

Figure 6-27: Areas of Other Land per Reporting Category



6.8 Harvested Wood Products (CRF 4.G)

Harvested Wood Products have been a decreasing net-sink throughout the period (average $-1.0 \text{ MtCO}_{2\text{eq}}$).

Data for production, imports and exports was derived from UNECE for the period 1970-2021. The production of HWP that came from domestic harvest was estimated using IPCC equation 12.4. The results are presented in the figures below.

Product grades considered were wood pulp (UNECE product code 7, half-life of 2 years); wood panels (UNECE product code 6, half-life of 25 years) and sawn wood (UNECE product code 5, half-life 35 years). The results are presented in Figure 6-31.

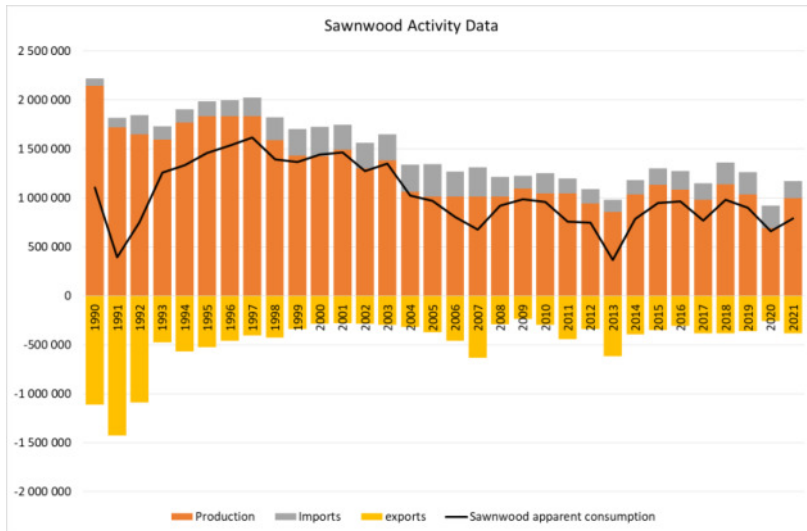

Figure 6-28: Reported Activity Data for Harvested Wood Products – Sawnwood

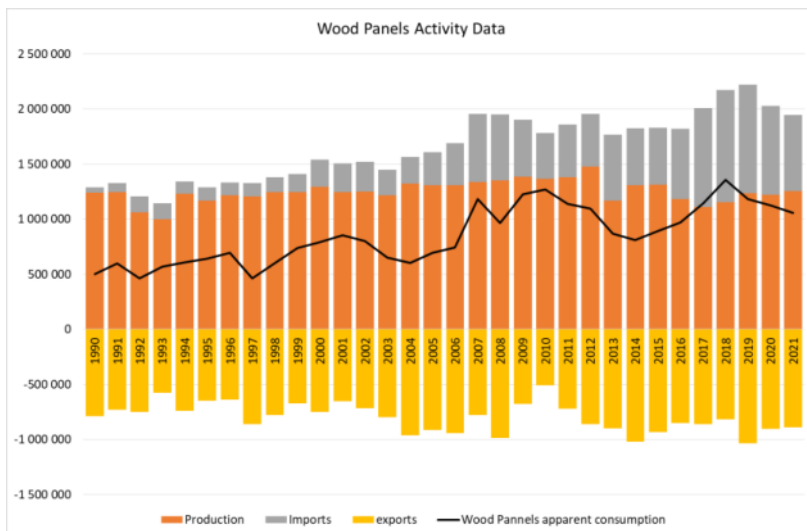

Figure 6-29: Reported Activity Data for Harvested Wood Products – Wood Panels

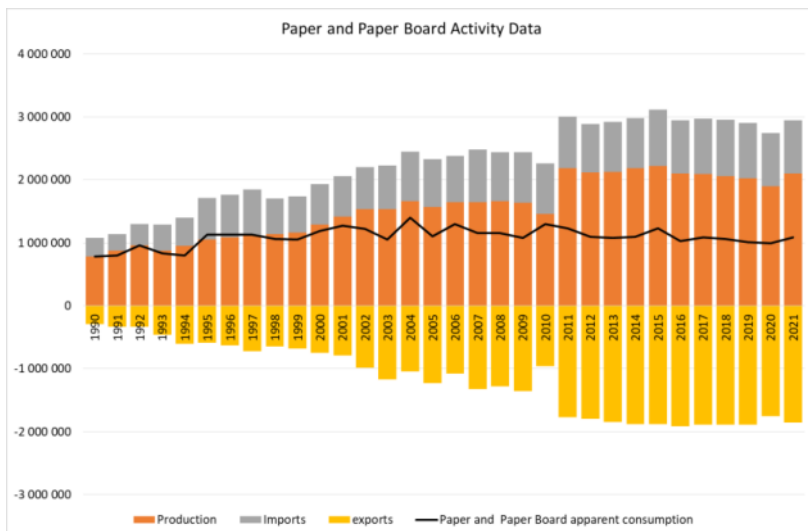

Figure 6-30: Reported Activity Data for Harvested Wood Products – Paper and Paper Board

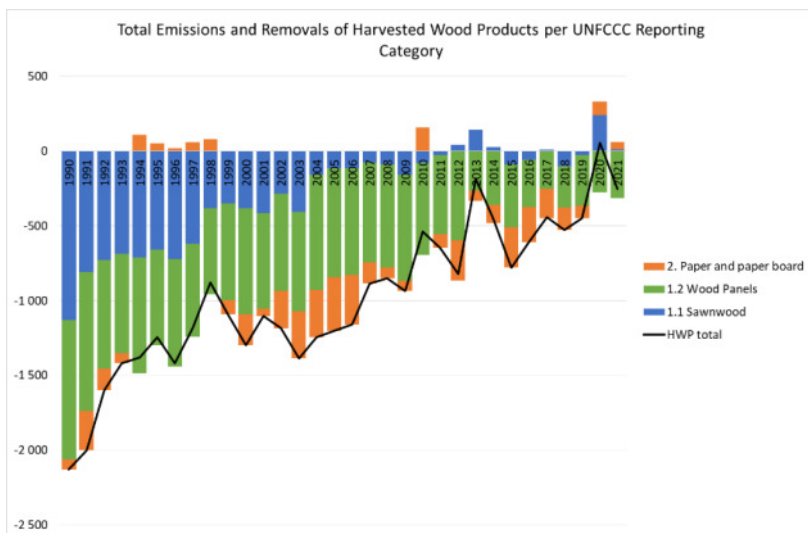

Figure 6-31: Evolution of Carbon Stocks and Carbon Stock Changes in Harvested Wood Products

6.9 Direct N₂O Emissions from N-Inputs to Managed Soils (CRF 4(I))

Emissions are quantified together with N fertilization of cropland and grassland and are reported in the Agriculture sector, since it is not possible to distinguish amongst the fertilizers used in agriculture and in forestry or in other land-uses.

6.10 Emissions and Removals from Drainage and Rewetting and other Management of Organic and Mineral soils (CRF 4(II))

The source is considered negligible and is reported as “Not Occurring”. **Annex G: Identification of Organic Soils in Portugal** presents the information that supports that assessment.



6.11 Direct N₂O emissions from N Mineralization/Immobilization associated with Loss/Gain of Soil Organic Matter resulting from change of LU or management of Mineral Soils (CRF 4(III))

6.11.1 Activity Data

For the purposes of calculating this category, only the areas associated with land-use transitions where mineral soil C is being lost were considered (i.e. land-use transitions with negative soil emission factors see Table 6-15).

Therefore, the areas reported in CRF Table 4(III) are areas where mineralization is taking place. These may be smaller from those reported for in CRF Table 4.1, because some land-use changes have Carbon Gains and, consequently, do not contribute to this category. The result is presented in Figure 6-32.

As per IPCC guidance, emissions from “cropland remaining cropland” are reported in CRF 3.D.1.5, whereas all N mineralization taking place in other Land Use Categories is reported under CRF 4(III).

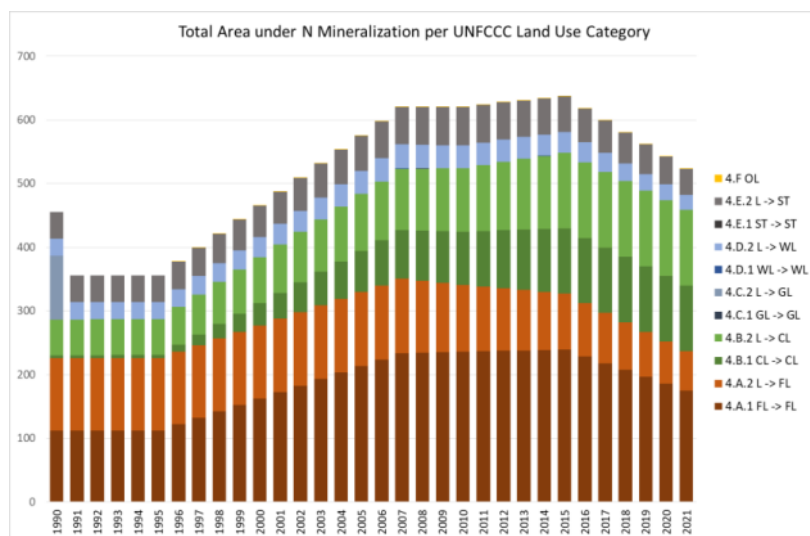

Figure 6-32: Total Area under N Mineralization (kha)

6.11.2 Emission estimation

Emissions from N₂O were estimated based on the areas where loss of soil carbon was taking place as a result of land-use change.

Equation 6-13: Emissions from N₂O

$$N_2O - N_{C_{Loss}} = EF_1 \times \Delta C_{LC_{Mineral}} \times \frac{1}{C:N \text{ ratio}} \times 10^{-6}$$

Where:

$N_2O - N_{C_{Loss}}$ = N₂O emissions associated with a Soil Carbon Loss, Gg N₂O-N.yr⁻¹

EF_1 = IPCC default emission factor used to calculate emissions from agricultural land caused by added N, whether in the form of mineral fertilizers, manures, crop residues and N mineralized from mineral soils as a result of loss of soil C, kg N₂O-N.kg⁻¹ N. (The default value used is 0.01 kg N₂O-N.kg⁻¹ N, IPCC table 11.1)

$\Delta C_{LC_{Mineral}}$ = C emissions from land use change

The same methodology was applied to estimate emissions from N mineralization in mineral soils in CRF 3.D.1.5.

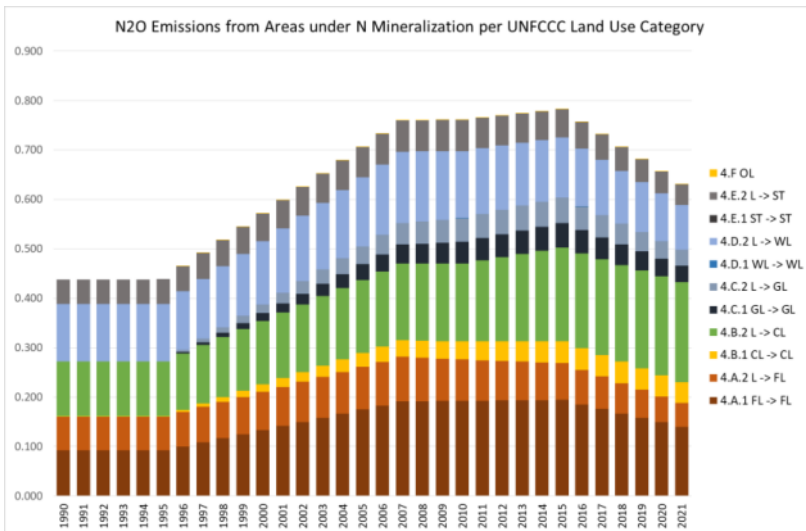

Figure 6-33: N₂O Emissions from Areas under N Mineralization (kt N₂O)

6.12 Indirect N₂O Emissions from managed soils (CRF 4(IV))

Indirect emissions reported in this section consider only:

1. Indirect emissions from leaching and runoff resulting from the loss of SOM (CRF 4(III))
2. Indirect emissions from atmospheric deposition resulting from emissions of NO_x and NH₃ from forest fires (CRF 4(V))

The methodologies and emission factors used are described in section “5.7.2 Indirect N₂O Emissions from Managed Soils” in the Chapter 5 (Agriculture).

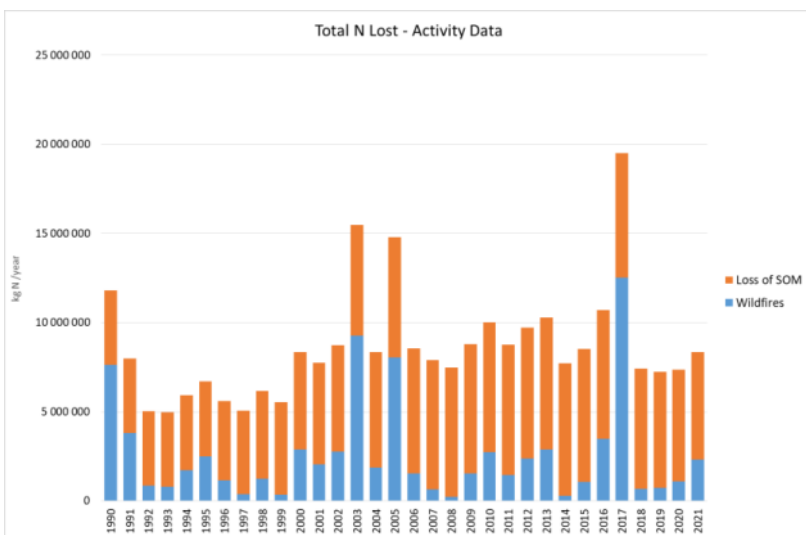

Figure 6-34: Total N Lost per Source

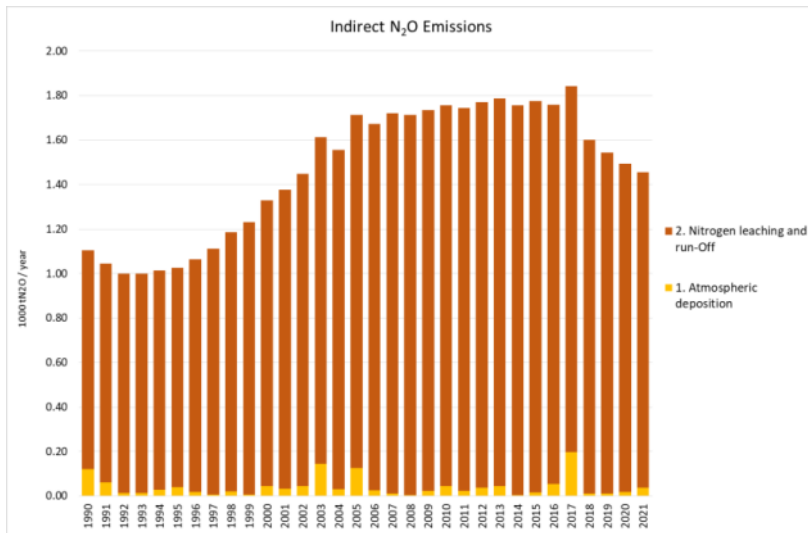

Figure 6-35: Total Indirect N₂O Emissions



6.13 Emissions from Biomass Burning (CRF 4(V))

Forest Fire Emissions are estimated as the sum of:

- Direct CO₂ emissions, i.e., CO₂ emissions that occur *during the fire*
- Direct non-CO₂ emissions, i.e., CH₄ and N₂O emissions that occur *during the fire*
- Indirect CO₂ emissions, i.e., CO₂ emissions that occur *after the fire, but as a consequence of the fire, i.e.,* from tree mortality caused by wildfires

The following pools and gases included in the estimations of fire emissions:

- Direct emissions (CO₂)
 - Living Biomass – AGB: Included (forests, shrublands, permanent crops)
 - Living Biomass – AGB: Not included (annual crops, pastures, wetlands)
 - Living biomass – BGB: Not included
- Direct emissions (CH₄ and N₂O)
 - Living Biomass – AGB: Included (forests, shrublands, permanent crops, annual crops, pastures, wetlands)
 - Living biomass – BGB: Not included
- Indirect emissions (CO₂)
 - Living Biomass – AGB: Included (forests, if above emissions from industrial harvest)
 - Living Biomass – AGB: Included (shrublands, permanent crops)
 - Living biomass – BGB: Included (forests, if above emissions from industrial harvest and shrublands, permanent crops)

6.13.1 Estimation of Burnt Areas

The main sources of burnt areas are the fire reports issued every year by the National Forest Authority, currently the Institute for Nature Conservation and Forestry (ICNF 1990-2020). The reports are derived from satellite imagery and the results cover all burnt areas.

Estimates for burnt area per land use type have been revised by overlapping the annual fire maps with the land-uses observed in COS maps. This ensures consistency between fire land-use data and the land-use data used in the inventory more broadly.

Estimates for the Autonomous Region of Madeira (RAM) were provided by the Secretaria de Recursos Naturais, and include only two broad classes: “burnt forest”; and “burnt shrubland”. Allocation to forest type was made assuming the same area distribution as reported in total area per forest type.

There are no forest fires in the Autonomous Region of Azores.

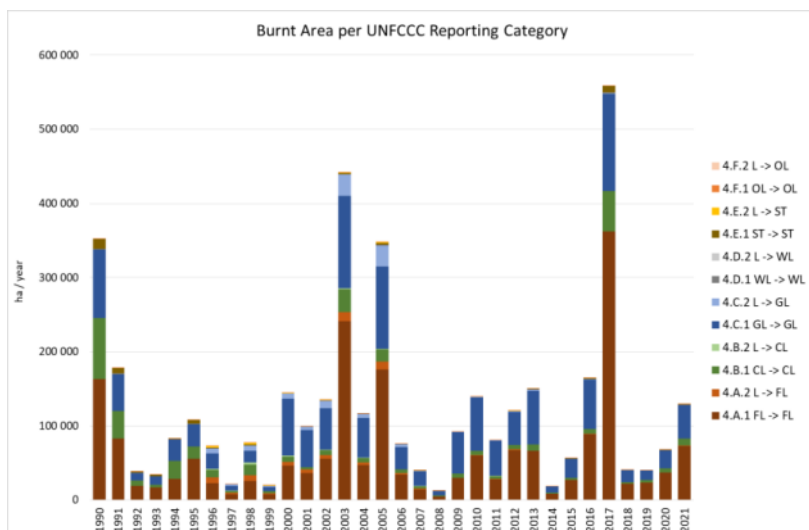

Figure 6-36: Burnt Areas per Reporting Category (ha)

6.13.2 Estimation of Biomass Loss due to Fires

The loss of biomass during forest fires was estimated by multiplying the above ground biomass in each land-use with its combustion factor.

According to Rosa (2009) forest fire emissions are much more related to biomass of smaller sizes than to total biomass, as they tend to present much higher combustion factors.

An estimation of the finer particles present in forest was made identifying the following components: leaves, small branches and litter.

As there were no values on combustion factors for these land-use types, a conservative approach was taken and the combustion factor was assumed to be 100%. This assumption considers that 100% of all dead trees (including roots) is oxidised during a fire. This approach is needed as there is no information to adequately characterize gains and losses of this pool. The consequence is an overestimation of emissions in the year of fire, but also an underestimation of emissions in the following years. However, it should be noted that all emissions are reported and the approach is consistent over the entire time series (i.e., the system does not consistently bias results in relation to present versus future emissions).

A summary of the values used in estimating biomass loss due to fires is presented in Table 6-17.

Table 6-17: Combustion Factors per Biomass Component used in the Estimation of Fire Emissions

Land-use Type	Share of AG Tree Biomass		Combustion Factor				AG Biomass
	Leaves %	Small branches %	Leaves %	Small branches %	Litter %	Shrubs %	
Pinus pinaster	7%	11%	88%	58%	75%	72%	-
Quercus suber	13%	21%	88%	58%	75%	72%	-
Eucalyptus spp.	9%	7%	88%	58%	75%	72%	-
Quercus rotundifolia	16%	27%	88%	58%	75%	72%	-
Quercus spp.	21%	54%	88%	58%	75%	72%	-
Other broadleaves	21%	54%	88%	58%	75%	72%	-
Pinus pinea	5%	8%	88%	58%	75%	72%	-
Other coniferous	8%	12%	88%	58%	75%	72%	-
Rainfed annual crops	-	-	-	-	-	-	100%
Irrigated annual crops	-	-	-	-	-	-	-
Rice padies	-	-	-	-	-	-	-
Vineyards	-	-	-	-	-	-	100%
Olive groves	-	-	-	-	-	-	100%
Other permanent crops	-	-	-	-	-	-	100%
All grasslands	-	-	-	-	-	-	100%



6.13.3 Direct CO₂ Emissions from Fires

Direct CO₂ emissions from fires were estimated using Equation 6-18.

Equation 6-14: Estimation of Direct CO₂ Emissions from Fires

$$E_{CO_2} = \sum_x BA_x \times BLF_x \times Cf \times CtoCO_2$$

Where:

E_{CO_2} = Emissions of CO₂ (tCO₂)

BA_x = Burnt area of land-use x (ha)

BLF_x = Biomass Loss due to Fires in Land-use x (tdm/ha)

C_f = Carbon fraction of Dry Matter (%)

$CtoCO_2$ = Stoichiometric conversion from Carbon to CO₂ (44/12)

6.13.4 Direct CH₄ Emissions from Fires

Direct CH₄ emissions from fires were estimated using the following equation:

Equation 6-15: Estimation of Direct CH₄ Emissions from Fires

$$E_{CH_4} = \sum_x BA_x \times BLF_x \times Cf \times C/CH_4 \times CtoCH_4$$

Where:

E_{CH_4} = Emissions of CH₄ (tCH₄)

BA_x = Burnt area of land-use x (ha)

BLF_x = Biomass Loss due to Fires in Land-use x (tdm/ha)

C_f = Carbon fraction of Dry Matter (%)

C/CH_4 = Carbon Lost as CH₄ (IPCC Default = 0.012)

$CtoCH_4$ = Stoichiometric conversion from Carbon to CH₄ (1.33)

6.13.5 Direct N₂O Emissions from Fires

Direct N₂O emissions from fires were estimated using the following equation:

Equation 6-16: Estimation of Direct N₂O Emissions from Fires

$$E_{N_2O} = \sum_x BA_x \times BLF_x \times Cf \times N/C \times N/N_2O \times NtoN_2O$$

Where:

E_{N_2O} = Emissions of N₂O (t N₂O)

BA_x = Burnt area of land-use x (ha)

BLF_x = Biomass Loss due to Fires in Land-use x (tdm/ha)

C_f = Carbon fraction of Dry Matter (%)

N/C = Nitrogen Carbon Ratio (IPCC Default = 0.01)

N/N_2O = Nitrogen Lost as N₂O (IPCC Default = 0.007)

$NtoN_2O$ = Stoichiometric conversion from Nitrogen to N₂O (3.14)

6.13.6 Indirect CO₂ Emissions from Fires

Indirect emissions are defined as those that not released during the forest fire but are attributed to fires, i.e. following tree mortality. They are estimated following the flow described in Figure 6-31.

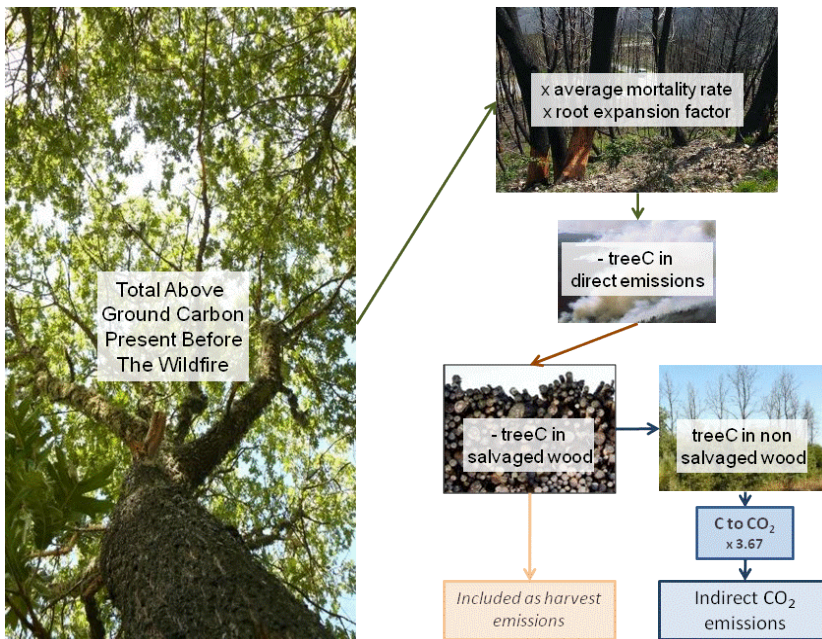

Figure 6-37: Estimation of Indirect Fire Emissions

Average Mortality Rates were estimated by expert judgement, as presented in Table 6-18.

Table 6-18: Fire Mortality Rates

Land-use Type	Mortality %
Pinus pinaster	70%
Quercus suber	30%
Eucalyptus spp.	50%
Quercus rotundifolia	10%
Quercus spp.	30%
Other broadleaves	30%
Pinus pinea	30%
Other coniferous	70%

Salvage wood is considered included in “losses from industrial harvest”. Therefore, indirect emissions are only considered when the total loss of carbon is higher than the value reported as industrial harvest and direct emissions.

The results of the estimations are presented in the next figure.

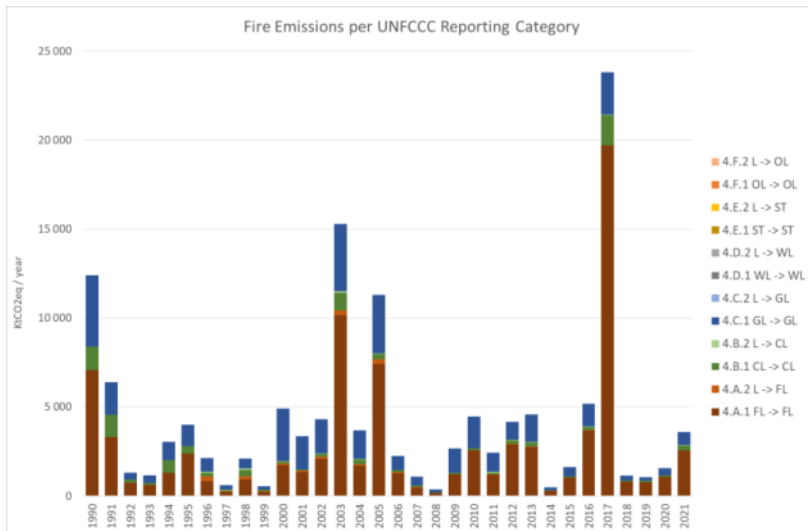

Figure 6-38: Total Emissions from Biomass Burning per Land-use Category

6.14 Uncertainty Assessment

Portugal made in 2022 an extensive recalculation of the LULUCF sector. Unfortunately it was still not possible to revise and present in this submission the uncertainty estimates for LULUCF.

6.15 QA/QC

QA/QC procedures included a series of checks: calculation formulas verification, data and parameters verification, and the information provided in this report.

Where applicable cross-checks and consistency checks between data submitted for the UNFCCC and KP reporting were also made.

Particular attention was given to the consistent application of the 20 years conversion period and the “since 1990” in both the UNFCCC and KP reporting.

Issues detected by and recommendations made by the Joint Research Centre were also considered, following the QA/QC procedures implemented by JRC in the compilation of the inventory submission for the EU.

Finally, issues detected by and recommendations made by the Expert Review Teams in previous UNFCCC reviews were also considered and, where possible, corrected.

6.16 Recalculations and Data Improvements

No recalculations were made in 2023 submission. However, after the submission of the NIR in April 2022, Portugal made a re-submission of the CRF tables and NIR in July 2022, where significant changes were included in the LULUCF chapter.

For this reason, Portugal includes below the main methodological changes and variables updates that occurred in the 2022 submission:

- Revision of land-use and land-use change data, reflecting the release of new COS and the revisions of previous COS (mainland Portugal) and the update of CLC maps information for the Autonomous Regions of Azores and Madeira
- Change in methodology to estimate harvest and allow a reconciliation of total carbon stocks derived from the National Forest Inventory and those from the GHG Inventory
- Introduction of new emission and sequestration factors for Permanent Crops, from Project LIFE MediNet



- Integration of Shrublands in “Grasslands” and not “Other Land”, following a recommendation from previous UNFCCC reviews
- Harmonization of the methodology to estimate burnt areas per land-use type with land use and land-use change information, which are now estimated by overlapping the COS maps with the Annual Burnt Area maps provided by ICNF
- Inclusion of CO₂ emissions (and subsequent removals) from burnt areas of shrublands and permanent crops
- Update of harvest and HWP input data 2012-2020, reflecting the latest version of the UNECE/FAO Timber Products database.

The impact of these recalculations in the final totals is presented in Figure 6-39.

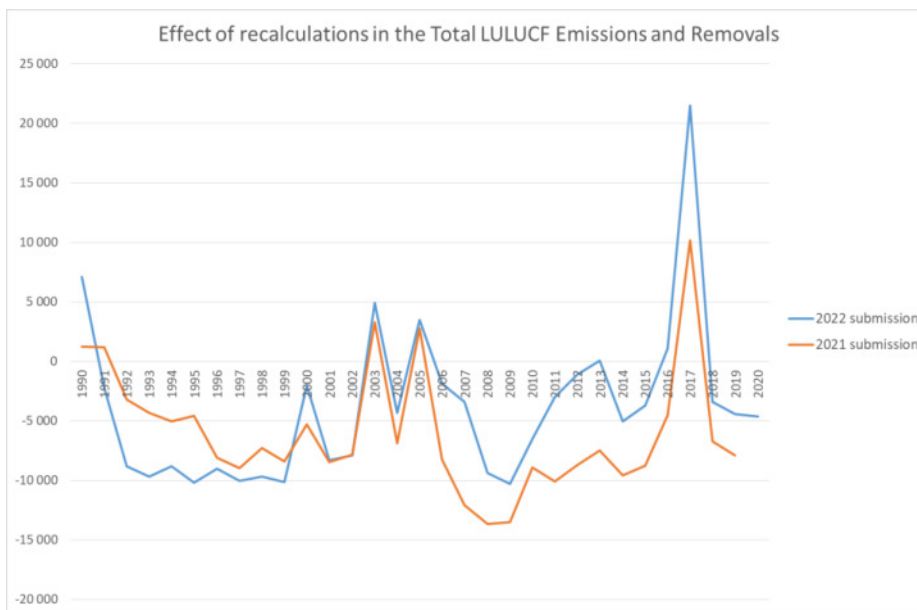

Figure 6-39: Effect of recalculations in the Total LULUCF Emissions and Removals

6.17 Further Developments

Portugal has been doing significant efforts to achieve a higher methodological level, identifying opportunities for improvements towards a full Tier 2 type of information, in order to guarantee a more complete, transparent and accurate reporting of the activities associated with LULUCF sector.

In particular, a revision of the soil emission and sequestration factors, taking into account the new data released by LUCAS Soil is being planned.

7 Waste (CRF Sector 5)

Table of Contents

7	Waste (CRF Sector 5)	7-1
7.1	Overview of the sector	7-5
7.1.1	Emission trends	7-5
7.1.2	General evolution of the waste sector and data trends	7-11
7.1.3	Data sources on solid waste	7-14
7.2	Solid Waste Disposal (CRF 5.A)	7-16
7.2.1	Category description	7-16
7.2.2	Methodological issues	7-17
7.2.3	Uncertainty assessment	7-26
7.2.4	Category specific QA/QC and verification	7-26
7.2.5	Category specific recalculations	7-27
7.2.6	Category specific planned improvements	7-27
7.3	Biological Treatment of Solid Waste (CRF 5.B)	7-28
7.3.1	Category description	7-28
7.3.2	Methodological issues	7-28
7.3.3	Uncertainty assessment	7-29
7.3.4	Category specific QA/QC and verification	7-30
7.3.5	Category specific recalculations	7-30
7.3.6	Category specific planned improvements	7-30
7.4	Waste Incineration (CRF 5.C)	7-31
7.4.1	Category description	7-31
7.4.2	Methodological issues	7-32
7.4.3	Uncertainty Assessment	7-39
7.4.4	Category specific QA/QC and verification	7-40
7.4.5	Category specific recalculations	7-41



7.4.6	Category specific planned improvements	7-41
7.5	Wastewater Treatment and Discharge (CRF 5.D).....	7-42
7.5.1	Category description	7-42
7.5.2	Methodological issues	7-42
7.5.3	Uncertainty assessment	7-64
7.5.4	Category specific QA/QC and verification	7-65
7.5.5	Category specific recalculations	7-65
7.5.6	Category specific planned improvements	7-65
7.6	Biogas burning without energy recovery (CRF 5.E)	7-66
7.6.1	Category description	7-66
7.6.2	Methodological issues	7-66
7.6.3	Uncertainty Assessment	7-67
7.6.4	Category specific QA/QC and verification	7-67
7.6.5	Category specific recalculations	7-67
7.6.6	Category specific planned improvements	7-67

List of Figures

Figure 7-1: Greenhouse gas emissions from the waste sector in 2021	7-5
Figure 7-2: Emissions of direct GHG from waste in percentage of national total by gas (2021)	7-6
Figure 7-3: Emission trends of GHG from waste by gas	7-8
Figure 7-4: Emission trends of GHG from waste by sub-category	7-9
Figure 7-5: Municipal waste	7-12
Figure 7-6: Municipal waste treatment by final destination.....	7-13
Figure 7-7: Population served by waste collection systems.....	7-18
Figure 7-8: Quantities of fermentable industrial waste disposed to SWDS.....	7-19
Figure 7-9: Total industrial waste by treatment types	7-20
Figure 7-10: Geographical location of Landfills and climatic conditions.....	7-24
Figure 7-11: Quantities of CH ₄ combusted (SWDS)	7-25
Figure 7-12: Quantities of waste Composted/ Digested and related emissions.....	7-29
Figure 7-13: Incineration of Municipal Solid Waste: quantities incinerated (kt) and related emissions (kt CO ₂ e) (accounted in CRF 1Aa).....	7-34
Figure 7-14: Incineration of Healthcare Waste: quantities incinerated (kt) and related emissions (kt CO ₂ e) 7-36	
Figure 7-15: Quantities of combusted industrial waste	7-37



Figure 7-16: Comparison between MSW incineration data used in the inventory and EB data 7-40

Figure 7-17: Wastewater and sludge BOD₅ produced according to handling systems and national population trends..... 7-47

Figure 7-18: Methane recovery 7-49

Figure 7-19: Industrial Wastewater load, expressed in COD, from major groups of industrial activity 7-56

Figure 7-20: Methane recovery (Industry) 7-56

Figure 7-21: N₂O emissions from wastewater and per capita protein intake 7-61

List of Tables

Table 7-1: Total Greenhouse Gas Emissions from Waste Mt CO₂eq..... 7-7

Table 7-2: Key categories in the Waste sector (CRF 5) and methodologies used in emission estimates 7-11

Table 7-3: Calculation methods and types of emission factors for emissions on Solid Waste Disposal on Land 7-16

Table 7-4: CH₄ emissions from solid waste disposal on land (kt CO₂e.) 7-16

Table 7-5: Municipal waste composition disposed to SWDS and DOC 7-21

Table 7-6: Industrial organic waste composition and DOC 7-23

Table 7-7: Parameters used in Lo calculation..... 7-23

Table 7-8: CH₄ in landfill gas 7-25

Table 7-9: Emissions from Biological Treatment of Solid Waste (ktCO₂e)..... 7-28

Table 7-10: Calculation methods and types of emission factors for emissions on Solid Waste Disposal on Land 7-28

Table 7-10: Default emission factors for CH₄ and N₂O emissions from biological treatment (wet weight basis) 7-29

Table 7-11: Emissions from Waste Incineration (ktCO₂e)..... 7-31

Table 7-13: Calculation methods and types of emission factors for emissions on Solid Waste Disposal on Land 7-32

Table 7-12: Base table for MSW C content estimation 7-34

Table 7-13: CO₂ Implied Emission Factors for CRF 1Aa 7-35

Table 7-14: Parameters considered: healthcare waste..... 7-36

Table 7-15: Parameters considered. 7-37

Table 7-16: Emissions factors of GHG and precursors gases from incineration of MSW 7-38

Table 7-17: Emissions factors of GHG and precursors gases from incineration of healthcare wastes: until 2004 7-39

Table 7-18: Emissions factors of GHG and precursors gases from incineration of healthcare wastes: after 2005 7-39



Table 7-19: Emissions factors of GHG and precursors gases for Industrial solid waste incineration	7-39
Table 7-20: Calculation methods and types of emission factors for emissions on wastewater treatment and discharge	7-42
Table 7-21: Emissions from Wastewater Treatment and Discharge (ktCO ₂ e).....	7-42
Table 7-22: Percentage of population by wastewater handling system	7-45
Table 7-23: Wastewater handling systems and associated fraction of organic load treated as liquid and solid phase	7-46
Table 7-24: Wastewater handling systems and associated Methane Conversion Factors (MCF)	7-48
Table 7-25: Pollution Coefficients to estimate Industrial organic wastewater production	7-52
Table 7-26: Sources of Information used to define the time-series of industrial production (1/2)	7-54
Table 7-27: Sources of Information used to define the time-series of industrial production (2/2)	7-55
Table 7-28: Fraction of industrial wastewater by wastewater handling system (% of total industrial load expressed as COD).....	7-58
Table 7-29: Methane Conversion Factors (MCF) and assumptions	7-58
Table 7-30: Comparison of Pollutant Coefficients from Cartaxo et al (1985) and IPCC defaults	7-60
Table 7-31: Data and parameters used calculation of N ₂ O emissions from wastewater.....	7-63
Table 7-32: Activity data, emission factors and related emissions of biogas combusted.....	7-67

List of Equations

Equation 7-1: CO ₂ emissions from MSW and industrial waste incineration	7-32
Equation 7-2: CO ₂ emissions from healthcare waste incineration.....	7-32
Equation 7-3: Non-CO ₂ emissions from waste incineration	7-38
Equation 7-4: Total organics in wastewater.....	7-42
Equation 7-5: Fraction of organics per wastewater handling system type.....	7-43
Equation 7-6: Emission Factors per wastewater handling system type.....	7-43
Equation 7-7: Total CH ₄ emissions from wastewater handling	7-43
Equation 7-8: CH ₄ emissions from industrial wastewater handling	7-50
Equation 7-9: Industrial organic wastewater load	7-50
Equation 7-10: Direct N ₂ O emissions from wastewater treatment plants.....	7-62
Equation 7-11: Indirect N ₂ O emissions from wastewater	7-62



7 Waste (CRF Sector 5)

Teresa Costa Pereira

Updated: April 2023

7.1 Overview of the sector

7.1.1 Emission trends

Waste management of industrial and municipal wastes are sources of GHG emissions. The inventory covers emissions resulting from landfilling, composting of organic waste, wastewater treatment, waste incineration and combustion of biogas.

The most important gas produced is CH₄, resulting from the anaerobic decomposition of organic waste disposed on land and from handling of wastewater treatment under anaerobic conditions. N₂O emissions are related with wastewater treatment and discharge of nitrogen into waterways.

CO₂ emissions in the waste sector are associated with incineration of waste containing fossil carbon, e.g. plastics. CO₂ emissions from biogenic origin are accounted as an information item.

Waste and wastewater treatment can also produce emissions of NMVOCs, NO_x, CO as well as NH₃ which are also estimated.

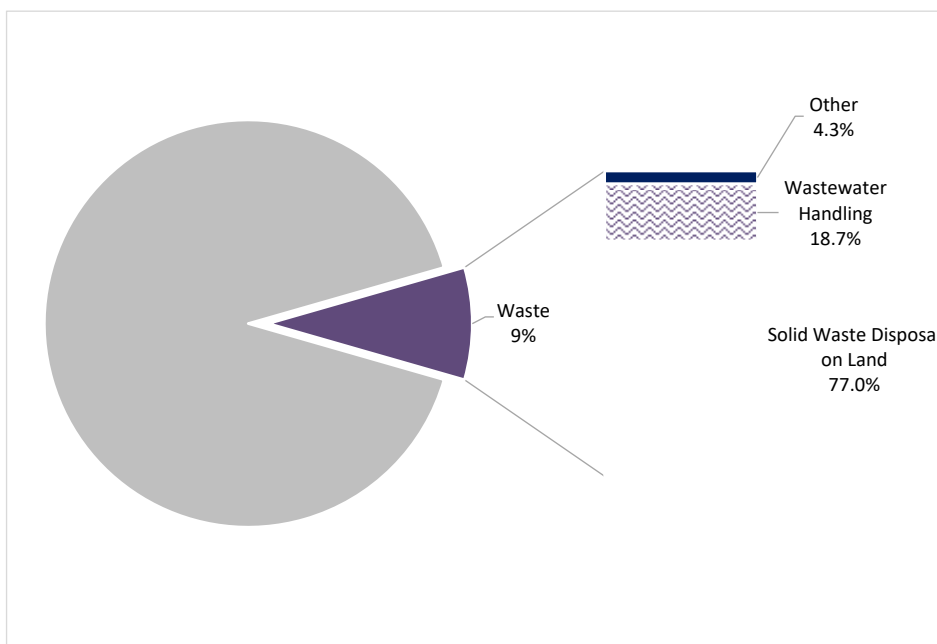

Note: Percentages may not sum 100% due to rounding

Figure 7-1: Greenhouse gas emissions from the waste sector in 2021

Emissions generated from waste activities are estimated, in 2021, as 5.0 Mt CO₂e, representing 9 % of total GHG emissions. The biggest sub-category within the sector refers to waste disposed on land (CRF 5A) – 3.9 Mt CO₂e - corresponding to approx. 77 % of the sector's emissions. Wastewater Handling (CRF 5D) contributes to the majority of the remaining emissions, with 19% of the sector emissions. Additionally, biological treatment of waste and waste incineration without energy recovery (which occur in health care and industrial waste units) represent minor shares of the sector emissions with 2.6% and 1.7%, respectively.



Waste incineration with energy recovery includes Municipal incineration units (waste-to-energy facilities) and industrial plants (cement plants) reported under Energy sector 1A. Emissions from biogas combustion with energy recovery are also reported in CRF 1A1a.

Other waste treatment (CRF 5E) includes emissions from biogas burning without energy recovery.

The contribution of each greenhouse gas emissions from this sector to the national emissions, expressed in CO₂eq, in 2020 is: CH₄ emissions 45.8%; N₂O emissions 6.3 % and CO₂ emissions 0.1 %.

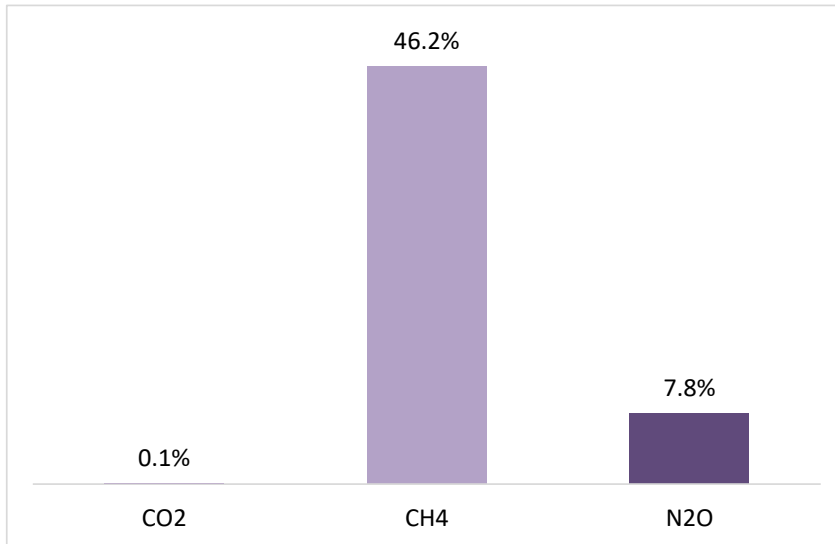

Figure 7-2: Emissions of direct GHG from waste in percentage of national total by gas (2021)



Table 7-1: Total Greenhouse Gas Emissions from Waste Mt CO₂eq.

Source /Gas	1990	2005	2019	2020	2021	Δ	Δ	Δ
	kt CO ₂ eq.					2021-2020	2021-2005	2021-1990
						%		
5.A Solid waste disposal								
CH ₄	3,159.12	5,372.40	4,010.50	3,887.61	3,855.60	-0.8	-28.2	22.0
5.B Biological treatment of solid waste								
CH ₄	5.63	14.64	94.85	69.39	88.17	27.1	502.2	1466.4
N ₂ O	3.20	8.31	47.22	34.12	43.48	27.4	422.9	1260.2
5.C Incineration of waste (without energy recovery)								
CO ₂	7.07	11.64	27.50	33.51	36.91	10.2	217.1	421.8
CH ₄	38.03	31.26	29.65	29.84	29.95	0.4	-4.2	-21.2
N ₂ O	20.55	17.48	16.18	16.26	16.24	-0.2	-7.1	-21.0
5.D Wastewater treatment								
CH ₄	1,698.81	1,556.97	824.55	777.55	769.08	-1.1	-50.6	-54.7
N ₂ O	177.85	213.77	171.99	166.61	168.48	1.1	-21.2	-5.3
5.E Other (biogas burning)								
CH ₄	NO	0.0075	0.0011	0.0016	0.0001	-96.2	-99.2	-
N ₂ O	NO	0.0071	0.0010	0.0015	0.0001	-96.2	-99.2	-
Total								
CO ₂	7.07	11.64	27.50	33.51	36.91	10.2	217.1	421.8
CH ₄	4,901.58	6,975.28	4,959.55	4,764.40	4,742.79	-0.5	-32.0	-3.2
N ₂ O	201.59	239.56	235.38	216.99	228.19	5.2	-4.7	13.2
Total All gases	5,110.24	7,226.48	5,222.43	5,014.89	5,007.90	-0.1	-30.7	-2.0
1.A.1.a Incineration of waste (with energy recovery)								
CO ₂	0.00	337.46	458.88	468.79	409.66	-12.6	21.4	-
CH ₄	0.00	6.95	7.90	7.60	8.26	8.7	18.8	-
N ₂ O	0.00	14.01	15.85	15.24	16.57	8.7	18.2	-

Note: Totals may not sum due to independent rounding. Emissions values are presented in CO₂eq mass units using IPCC AR5 GWP values (CH₄ - 28; N₂O - 265).

In the period 1990-2021 GHG emissions from waste activities recorded a variation -2%. The sector registered however a significant growth until the mid-years 2000's, recording an increase of more than 50% until 2004 and showing a general decreasing trend since then.

The evolution of the emissions in the sector is primarily related to the CH₄ emissions generated in Municipal Solid Waste landfilling, representing 77% of the sector emissions in 2021. This increase, is strongly related to the growth of waste generation driven by the change in consumption patterns associated with the steady economic growth in particular in the following years after the Portuguese accession to the EU in 1986. Another factor relates to the geographical distribution change of the Portuguese population, registering a significant increase of the population living in urban centres since 1960. This trend was accompanied by the development of waste collection systems: the population served by waste collection systems is estimated to have increased from 40% in 1960 to 100% in 2000 (Figure 7-7).

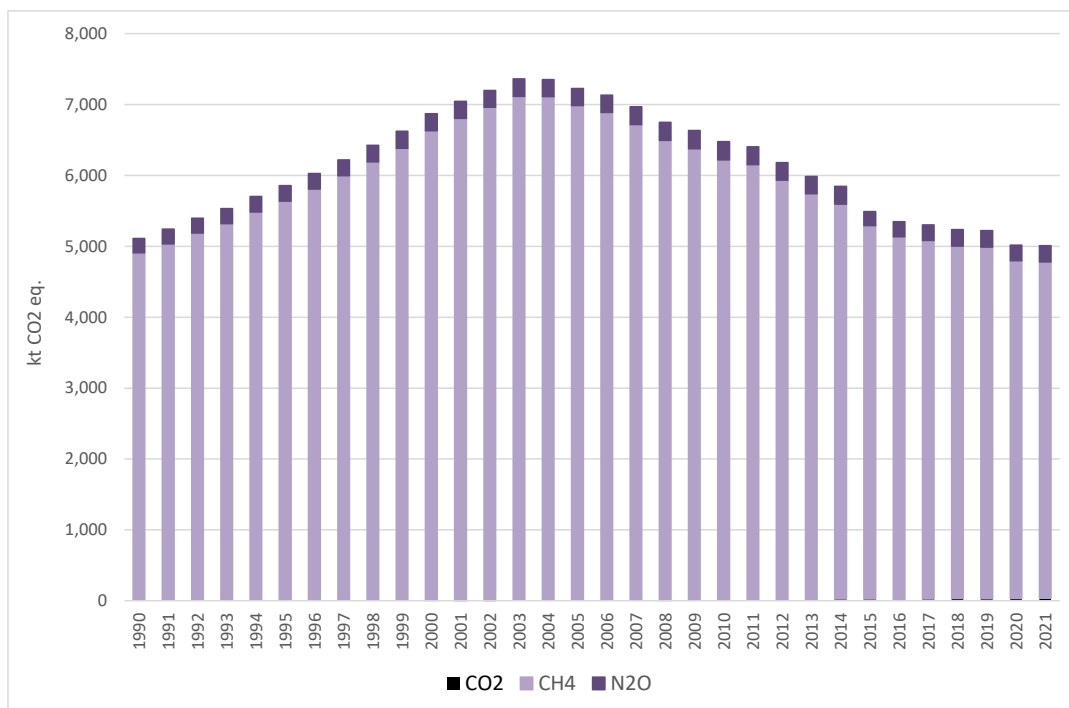

Figure 7-3: Emission trends of GHG from waste by gas

The strongest increase of emissions occurred until 2004. In the mid of 2000, emissions have first stabilized and started after to decrease, due in particular to the increasing importance of biogas burning that can occur with and without energy recovery. Landfill gas with energy recovery is burned in several units which produce and sell electricity to the grid.

Also, the quantities of separate collected waste, which have more than doubled since 1999, have deviate waste flows from SWDS and incineration units, and contributed to this trend.

The start of operation of two incineration units dedicated to MSW incineration in Portugal Mainland (1999), another incineration unit in the Autonomous Region of Madeira in 2001/2002, and more recently, at the end of 2015, one more in the Autonomous Region of Azores, also contribute to the sectoral trend. The emissions from MSW incineration occur with energy recovery and are therefore accounted in the energy sector (category 1A1a).

Emissions from biogas combustion are also accounted and are reported in the energy sector when there is energy recovery or in the waste sector when biogas is flared (without energy recovery).

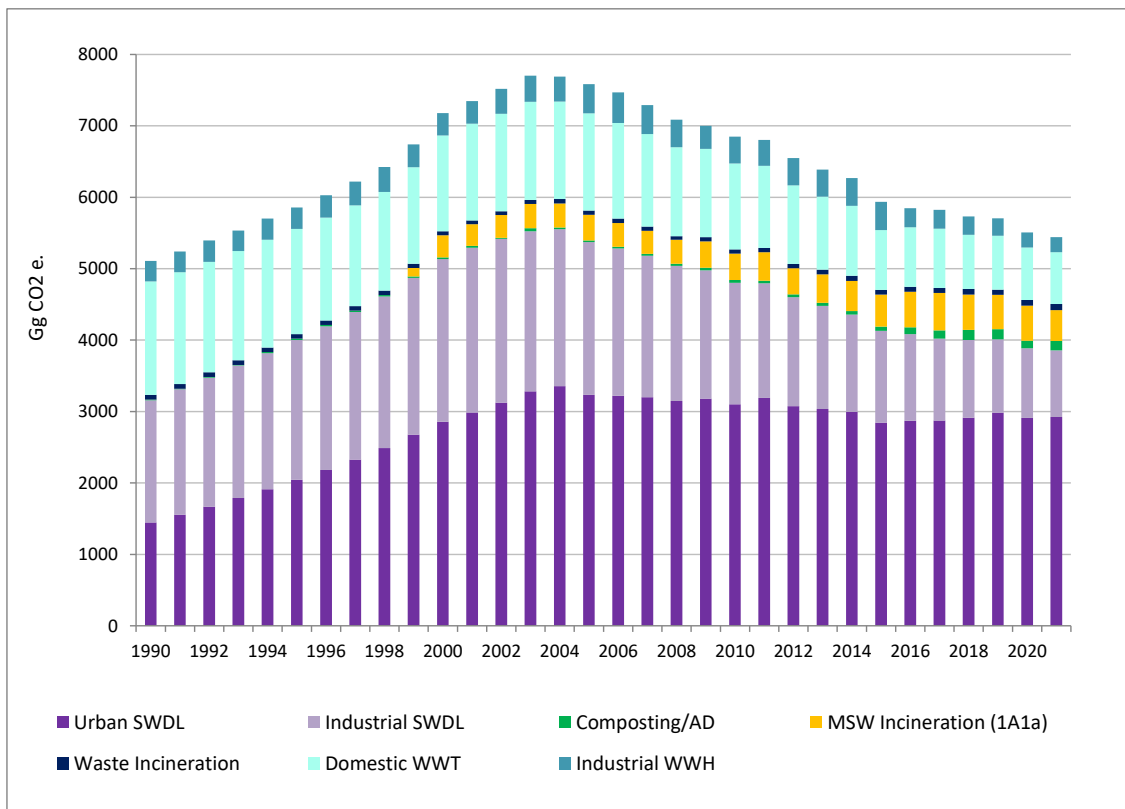

Figure 7-4: Emission trends of GHG from waste by sub-category

Recalculations

Changes in this submission refer to:

- Solid Waste Deposited on Land (5.A.1)

CH₄ emissions: revision of activity data on MSW deposited on land: 2016-2020; revision of activity data on industrial waste deposited on land: 2020.

- Biological treatment of Solid Waste (5.B)

Composting (5.B.1)/ CH₄ and N₂O emissions: revision of activity data for the years 2013-2020. This included the accounting of non-municipal organic and garden and park waste quantities not previously considered.

Anaerobic Digestion (5.B.2) / CH₄ emissions: revision of activity data for the years 2016-2020.

- Waste Incineration (5.C.1)

Industrial and Clinical waste: activity data update for 2019 and 2020.

- Open Burning of Waste (5.C.2)

CH₄ and N₂O emissions for the whole time series: following the 2022 NECD review, Portugal reallocated emissions from residues burning of vineyard, olive trees or orchard, previously reported in the agriculture sector, to category 5C2. The emissions from in place field burning (e.g. stubble burning) remained in category 3F.

- Industrial Wastewater Handling(5.D.2)

CH₄ emissions: revision of AD for some industrial sectors: 2020.

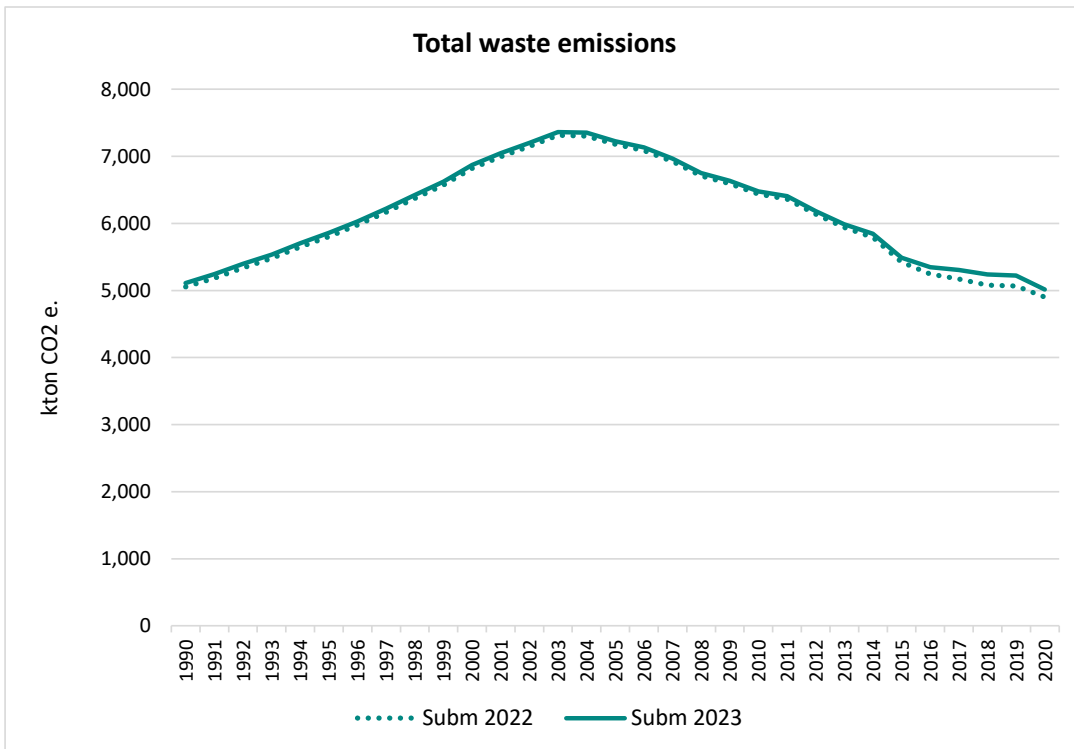

Figure 2.1 – Recalculations between 2022 and 2023 submissions in Waste Sector.

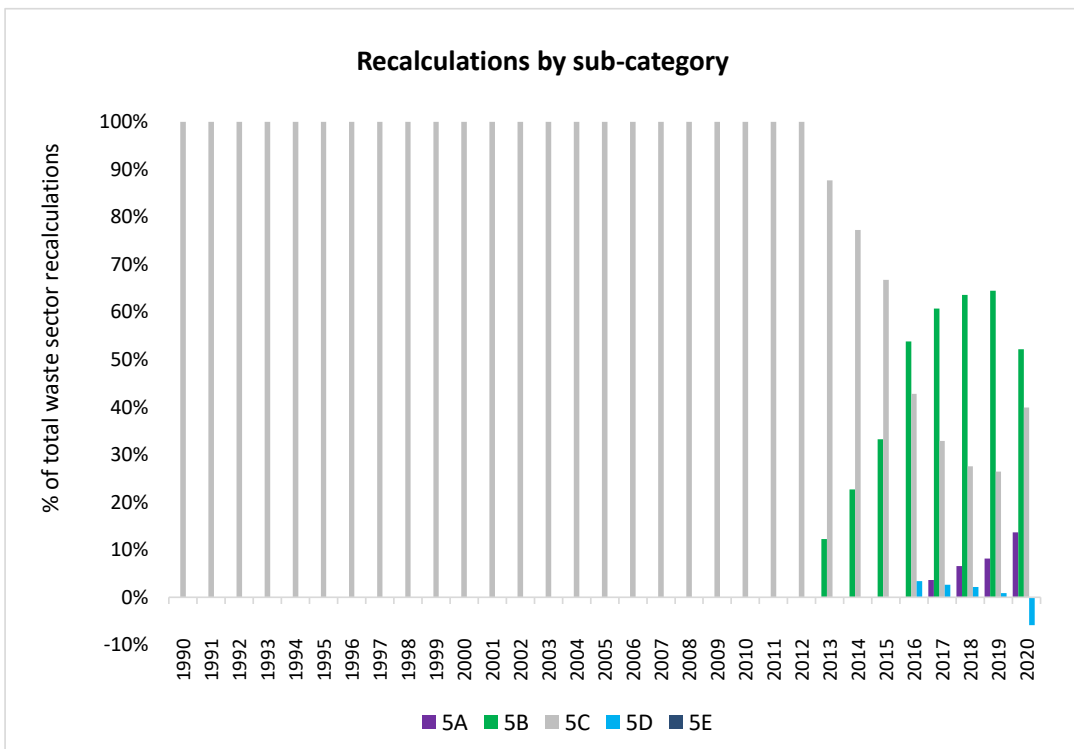

Figure 2.2 – Recalculations in the Waste sector by sub-category.



Key categories

The key categories related to the waste sector are summarised in table below.

Table 7-2: Key categories in the Waste sector (CRF 5) and methodologies used in emission estimates

IPCC category	Gas	Criteria	Method
5.A Solid waste disposal	CH ₄	L 1-2, T 1-2	T2
5.B Biological treatment of solid waste	CH ₄	L 2, T 2	T1
5.C Incineration and open burning of waste	CO ₂	L 2	T2
5.D Wastewater treatment and discharge	CH ₄	L 1-2, T 1-2	T2
5.D Wastewater treatment and discharge	N ₂ O	L 2, T 2	T1

7.1.2 General evolution of the waste sector and data trends

In the last three decades there has been a significant evolution in the management of municipal waste (MSW) systems. Leaving from a predominantly municipal management logic, in the period prior to 1995, the situation has evolved towards a multi-municipal management through the creation of multi-municipal systems and inter-municipal management of MSW.

Since the end of 2010, the management of MSW in Portuguese mainland has been under the responsibility of 23 entities, named as "Municipal Waste Management Systems – SGRU" (11 multi-municipal (private group) and 12 inter-municipal systems (majority public capital)). In the Autonomous Region of Azores, municipality authorities are the responsible entities for the management of MSW, and in the Autonomous Region of Madeira, this responsibility is shared between municipalities and the Regional Government.

The policy of management of municipal waste in Portugal has been defined through specific strategic plans for this sector.

The first Strategic Plan on Municipal Solid Waste (PERSU - "*Plano Estratégico dos Resíduos Sólidos Urbanos*"), approved in 1997, settled the main axis of action in this domain: the deactivation and closure of all uncontrolled dumping sites which occurred in 2002, the construction of environmentally sound management infrastructures and the development of separate collection.

In a second phase, after the construction of the adequate infrastructures for waste treatment and disposal, the Strategic Plan for Municipal Solid Waste, PERSU II (2007-2016), foreseen the construction of mechanical and biological treatment and recovery organic units, with a view to the recovery and recycling of the biodegradable waste fraction and their diversion from landfill, as well as the reinforcement of the equipment for the recovery of the multi-material fraction of waste.

In 2014, a new Strategic Plan for Municipal Solid Waste (PERSU 2020) covering the period 2014-2020 was approved. One of the main measures of this Plan is the promotion of the use of waste as a resource, giving priority to the upstream activity of the chain of value and the integration of the Urban Waste Prevention Program. Furthermore, it supports a significant increase in separate collection and recycling, and promotes the progressive elimination of direct landfilling.

Recognising that the level of ambition set by the new European targets for landfill disposal, preparation for reuse and recycling of urban waste, recycling of packaging and plastic reduction, as well as the new target for landfill disposal, pose highly complex challenges for Portugal, it has become imperative to take measures to realign the strategic lines that enable it to contribute to fulfilling its commitments. So, with that need in mind, PERSU 2020+ was approved in 2019, which is a strategic reflection and an adjustment to the measures contained in the PERSU 2020, which projects the interventions to be developed up to the year 2025. PERSU 2020 remains in force, except for the matters updated in PERSU 2020+.



The figure below presents the trends of SW generation amounts and the quantities of waste per type of final disposal.

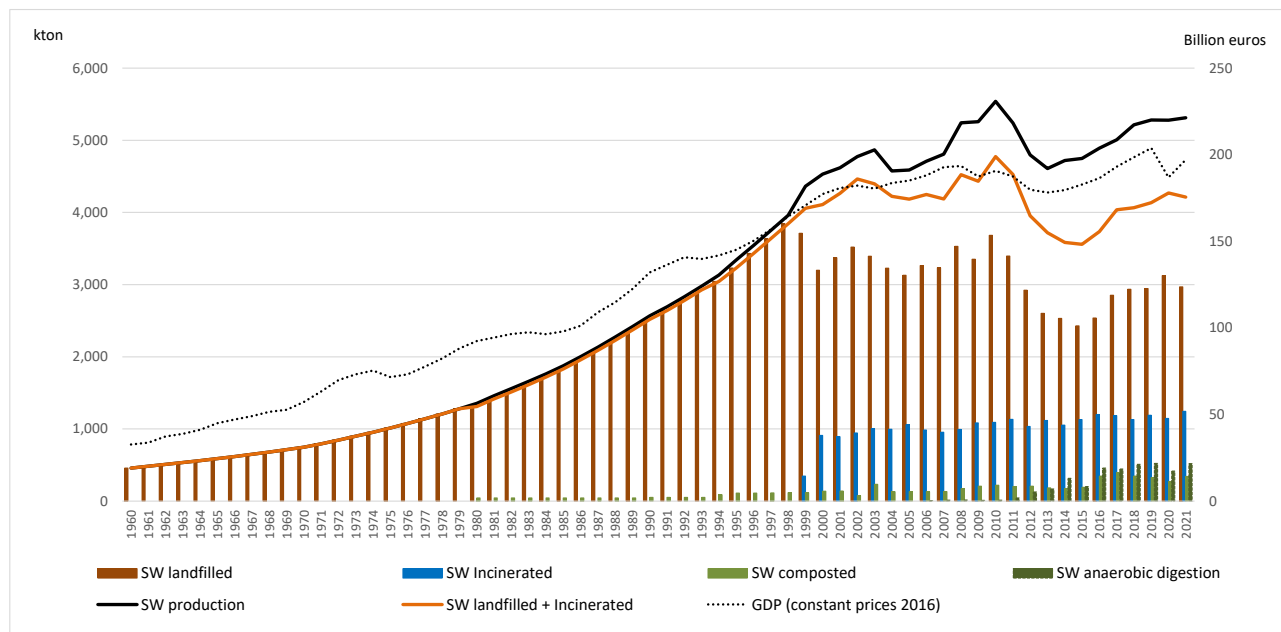

Source: APA, include estimates

Figure 7-5: Municipal waste

Waste generation registered an expressive growth during the 1990s, in association with the development of household income and the growth of urbanization recorded in the country during those years.

After the peak around the year 2010, total municipal solid waste (MSW) production presented mostly a decreasing tendency, resulting from prevention policies, but mostly due to the economic crisis effect on consumption.

In 2020, the GDP growing tendency verified since 2014 was broken due to the economic downturn caused by the COVID-19 viral pandemic. The shutdown measures to contain the pandemic have plunged the national economy into recession, with a registered downfall of 8.4% in GDP (2019/2020 variation).

With the exception of 2020 due to the pandemic crisis, Portugal registered since 2014 a growing trend of municipal waste production. This increase is believed to be related with an improvement of the economic situation of Portugal until 2019, seeming to indicate that the goal of decoupling waste production from economic growth is not being fulfilled.

Among the factors that explain these tendencies, is the remarkable growth of tourist inbound in Portugal before the pandemic crisis, contributing both to the Portuguese economic development and to the growth of municipal waste generation.

In 2021, the resumption of economic activity due to the easing of contingency measures concerning the COVID-19 pandemic, influenced all the national reality and, consequently, the waste sector.

In 2021, 5.3 million tons (t) of municipal waste were produced in Portugal, 1% more than in 2020.

The Portuguese MSW production per capita in 2021 corresponded to approx. 513 kg/year above the EU28 average per capita MSW production (http://ec.europa.eu/eurostat/statistics-explained/index.php/Municipal_waste_statistics).



Until the late '90s, landfilling remained almost exclusively the main waste treatment practice.

In 1999/2000, with the start of operation of two MSW incineration units in Mainland Portugal, in 2001/2002 one more in the Autonomous Region of Madeira, and at the end of 2015 another one in the Autonomous Region of Azores, waste started to be diverted from SWDS. All MSW incineration occur with energy recovery.

Although landfilling remains the main final destination for municipal waste, the disposal of waste in landfills have been progressively decreasing since 2010, with the exception of 2020 due to the pandemic crisis. In 2020, APA, together with ERSAR and DGS issued *Guidelines and Recommendations for waste management in pandemic situation of COVID-19*, that recommended, during a period of time, that SGRU should send mixed waste, directly and without any prior sorting, preferably for incineration, or to landfill when not possible to use incineration capacity or when the geographical location of the waste production would justify it. It was also recommended the closure of the mechanical treatment of mixed waste in order to reduce the exposure of workers.

The diversion of waste disposal from landfills has been accompanied by the growth of importance of Mechanical and Biological treatment as well as sorting units as foreseen in the Municipal Solid waste Strategic Plans (PERSUs) and the National Plan for Waste Management (PGNR 2014-2020). The number of waste management infrastructures for biological treatment have grown expressively in the last decade, with the aim to increase the direct diversion of biodegradable waste from landfills and increase recycling. As a consequence, composting has been growing in importance (exception for 2020). These measures have contributed also to an increase in multi-material recycling and the organic recovery and recycling of waste, with a consequent decrease of biodegradable waste in landfills.

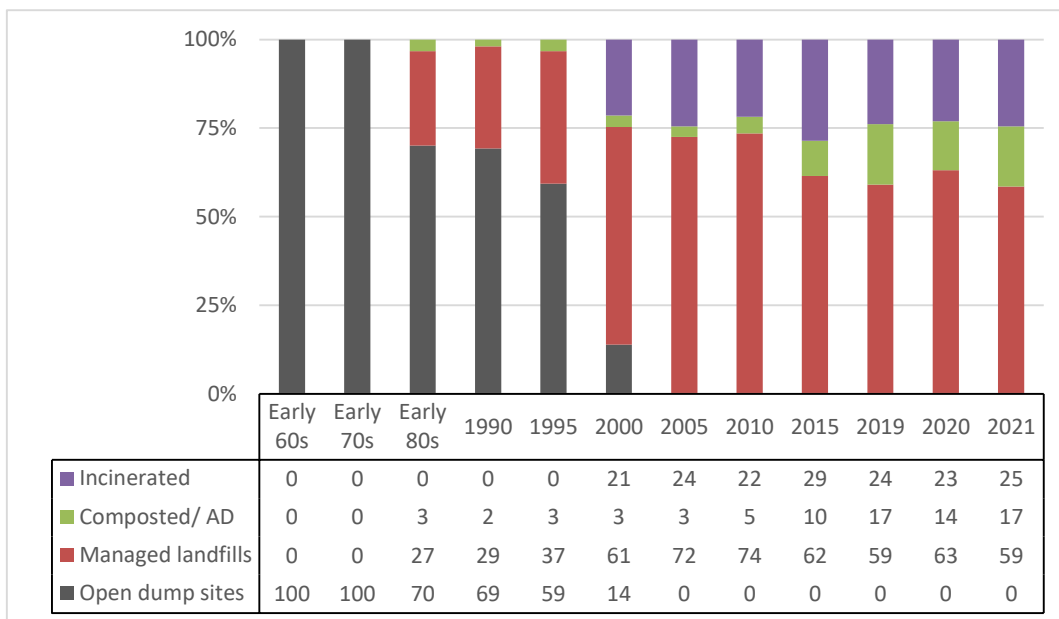

Note: The figure refers to the final destination of waste, which includes the "direct disposal of waste" and the "indirect disposal" of additional amounts of waste, understanding the latter as rejected amounts from the previous handling processes, such as mechanical treatment and screening.

Source: APA estimates

Figure 7-6: Municipal waste treatment by final destination.



7.1.3 Data sources on solid waste

From 1999 onwards, data on MSW is available for the majority of management systems, including generation amounts, final disposal and, to a less extent, waste composition.

For previous years, information on municipal waste was not collected on a regular basis, and most information was available from:

- PERSU - “*Plano Estratégico dos Resíduos Sólidos Urbanos*” (Strategic Plan on Municipal Solid Waste), which was approved by the Government in 1997. This plan includes data from annual municipal registries;
- a study performed by Quercus (1995) – “*Caracterização dos Resíduos Sólidos Urbanos e Inventariação dos Locais de Deposição em Portugal*” (Characterization of Municipal Solid Waste and Survey of Disposal Sites in Portugal). The study of Quercus (1995) considered open dump sites, managed landfills, composting and incineration units, covering aspects as the quantities of waste treated or landfilled and other characteristics (opening and closure year of operation, waste composition, existence of flaring equipment, etc). Data was based on a survey performed in 1994, which enabled the calculation of per capita generation rates for 1994, based on the amounts of waste collected and the population served by waste collection.

Since 1999, the information refers to data effectively collected and reported by the waste management systems, which details the different treatments: landfilling, incineration, composting/anaerobic digestion, and material recycling.

At present the National legislation refers to the Annex I of DL 102-D/2020, which approves the general waste management regime, the legal regime for the disposal of waste in landfills and amends the management regime for specific waste flows, transposing Directives (EU) 2018/849, 2018/850, 2018/851 and 2018/ 852.

Waste management policies have evolved towards the sustainable management of materials in order to protect, preserve and improve the quality of the environment, ensure the rational use of natural resources, and promote the principles of the circular economy.

The National entity responsible for the definition, implementation and supervising the waste policies is APA, I.P. through its Waste Department, which is also responsible for the verification, validation and treatment of the information collected via the Integrated System for Electronic Registry on Waste (SIRER) in the SILiAmb electronic platform.

The operators should upload on different registration maps the information regarding generation, trade, recovery and disposal of waste, including the origin of waste, the quantities generated and treated, the classification and the destiny of the waste.

The data collected is of the utmost relevance for a proper monitoring of the national reality in terms of waste. This information is the basis for an adequate national waste planning and for the assessment of the national policies implemented, including the possible need to reformulate them.

In addition, the information reported also allows close monitoring of the performance of those involved in the waste sector, whether waste producers, treatment operators and municipal or multi-municipal waste collection and/or treatment systems, in order to assess compliance with legal obligations, targets and to determine the waste management tax.



In terms of municipal waste, the data is reported in MRRU (Municipal Waste Registration Form), allowing the registration of quantities of municipal waste generated in each municipality and their treatment (landfilling, incineration, composting, recycling). Information on waste composition is also collected (the Ordinance 851/2009 defines the methodology for municipal waste characterization). At present, MRRU is filled in by municipal or multi-municipal waste collection and/or treatment systems from Portugal Mainland and from Autonomous Region of Madeira. Information for the Autonomous Region of Azores is collected under the framework of SNIERPA (National Inventory System). The MIRR is also filled in by producers/operators from Portugal Mainland and the Autonomous Region of Madeira.

As regards industrial waste treatment, the first set of data available was collected via an annual registry of industrial declarations received from the regional environment directorates (CCDR).

Data from 2008 onwards refer to data collected via SIRER (Integrated System for Electronic Registry on Waste), available from 2008 to 2011 through the SIRAPA platform, and since 2012 via the SILiAmb electronic platform. After data collection and the respective validation at APA, I.P., data is handled by the INE (National Statistical Office) in order to extrapolate the information to the universe of enterprises for each economic branch, due to the different scope required by the national legislation on waste registration and the Waste Statistics Regulation (Regulation (EC) no. 2150/2002).



7.2 Solid Waste Disposal (CRF 5.A)

7.2.1 Category description

Decomposition of organic waste does not occur instantaneously after disposal on land, but rather over a long period of time, and CH₄ is emitted at a diminishing rate. Different factors affect the generation of CH₄: Waste disposal practices (degree of control of disposal sites – in general, controlled placement of waste favours anaerobic activity and consequently landfill gas formation, but the gas can be recovered and be either flared or used for energy purposes); Waste composition (quantities of degradable materials is one major element influencing biogas production); and Physical factors (e.g. moisture content and temperature).

Solid waste disposal sites (SWDS), which include both managed landfills and open dump sites, can also produce directly significant amounts of CO₂. In fact, the decomposition of organic materials originates landfill gas or biogas consisting of approximately 50 % CH₄ and 50 % CO₂ by volume. However, this carbon dioxide results in its major part from oxidation of biomass materials and does not contribute hence to ultimate CO₂. Additionally, a much smaller percentage of landfill gas is composed of NMVOC and NH₃.

SWDS include municipal waste (household, garden, commercial-services wastes) and industrial wastes.

The source category solid waste disposal on land (SWDL) is a key category for CH₄, both in terms of level and trend.

Table 7-3: Calculation methods and types of emission factors for emissions on Solid Waste Disposal on Land

Source	Emissions reported	Methods	Activity Data	Emission Factors
5.A.1 Managed Waste Disposal	CH ₄	Tier 2	National data	CS, D
5.A.2 Unmanaged Waste Disposal	CH ₄	Tier 2	National data	CS, D

The table below presents the estimates of CH₄ emission from solid waste disposal on land.

Table 7-4: CH₄ emissions from solid waste disposal on land (kt CO₂e.)

Source	1990	2000	2005	2010	2015	2019	2020	2021
Municipal solid waste	1,448.3	2,858.3	3,234.8	3,103.2	2,845.8	2,981.5	2,908.8	2,924.0
- managed disposal sites	416.6	1,419.4	2,157.9	2,344.3	2,311.0	2,577.4	2,532.0	2,572.7
- unmanaged disposal sites	1,031.7	1,438.8	1,076.9	758.9	534.8	404.2	376.8	351.4
Industrial solid waste	1,710.8	2,277.1	2,137.6	1,699.6	1,285.0	1,029.0	978.8	931.6
- managed disposal sites	416.9	1,004.5	1,210.2	1,046.0	824.5	680.9	654.3	629.0
- unmanaged disposal sites	1,293.9	1,272.7	927.4	653.5	460.5	348.1	324.5	302.6
Total	3,159.1	5,135.4	5,372.4	4,802.7	4,130.8	4,010.5	3,887.6	3,855.6

Note: Totals may not sum due to independent rounding

CH₄ emissions from SWDL which represent the great majority (78%) of the emissions of the sector have grown around 22% since 1990 and register since 2004 a declining trend.



7.2.2 Methodological issues

7.2.2.1 Methods

Methane emissions are calculated on the basis of the First Order Decay Method (Tier 2), following the guidance from the 2006 IPCC Guidelines (Volume 5/ Chapter 3 on Solid Waste Disposal). The IPCC Waste Model was applied using Equations 3.2, 3.4, 3.5 and 3.6 and a single-phase approach based on bulk waste.

Parameter values used are:

- total amount of waste disposed;
- fraction of Degradable Organic Carbon (DOC);
- fraction of DOC dissimilated (DOCF);
- fraction of methane in landfill gas (F);
- methane correction factor (MCF);
- methane generation rate constant (k);
- landfill gas recovered (R);
- oxidation factor (OX).

7.2.2.2 Activity data and parameters

The use of the FOD method requires building a data time series for several decades in the past concerning waste quantities, composition and disposal practices. According to IPCC (2000, 2006), it is good practice to estimate historical data if such data are not available, when this is a key source category (ANNEX G). The extent of the time series has been set to 30 years, in order to follow the guidance from IPCC (2000, 2006) which recommends to consider data on solid waste disposal (amount, composition) for 3 to 5 half-lives of the waste deposited at SWDS.

7.2.2.2.1 Quantities of waste landfilled: municipal waste

The first studies available with information on municipal waste refer to PERSU (1997) and a study performed by Quercus (1995) with data from a survey performed in 1994, which enabled the calculation of per capita generation rates for 1994, based on the amounts of waste collected and the population served by waste collection.

Before 1994, data on landfill wastes had to be estimated based on expert judgment for waste generation growth rates. For the period 1960-1980 it was considered a per capita waste generation growth rate of 2.5% per year; for the following years (1980-1994) 3% per year. These assumptions were based on scarce information for municipal solid wastes quantities in Portugal mainland, which indicated a tendency of 3% in the period (1980-1985).

Therefore, for the period 1960-1994, municipal solid waste production was estimated for each municipality as follows:

[Population (inhabitants) * Annual amount of municipal waste generated per capita (t/inhabitant/year)]



Population data for resident population is available from periodical census made by the National Statistical Office (INE). Available years for the years concerned are: 1960, 1970, 1981, 1991, 2001, 2011 and 2021. Population data for intermediate years were estimated, by interpolation, for each municipality.

Since 1999, data on MSW are collected from management systems operators. The quantities of MSW production between 1994 and 1999 were estimated by interpolation.

To take into account the fact that part of the population (rural areas) was not served by an organised waste collection and waste disposal system, values of annual production were multiplied by the percentage of population served by waste collection in each municipality. After 2000, it was assumed that all the population of the country is served by waste collecting systems (100%). The total amount of waste disposed to SWDS was then calculated based on this estimated value minus the amounts of waste incinerated and composted or digested:

$$\begin{aligned} \text{Waste disposed to SWDS} = & [\text{Population} * \text{Annual amount of municipal waste generated per capita} * \\ & \text{Percentage of Population served by waste collection}] \\ & - \text{Quantity of incinerated waste} - \text{Quantity of composted/digested waste} \end{aligned}$$

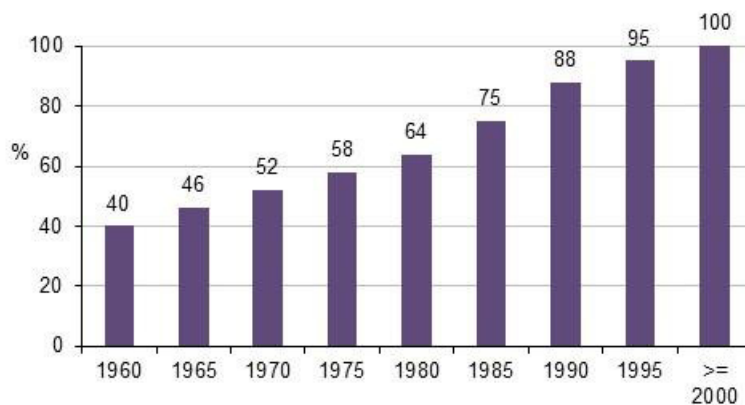

Source: APA

Figure 7-7: Population served by waste collection systems

7.2.2.2.2 Quantities of waste landfilled: industrial waste

Industrial wastes considered refer only to the fermentable part of industrial waste.

Historical time series are based on 1999 data, which refer to the first set of data available on industrial waste disposal that was collected via an annual registry of industrial declarations received from the regional environment directorates (CCDR). Data for the period 1960-1999 have been estimated based on expert judgment. For the years 1960-1990 a growth rate of 1.5% per year was considered, and for the following years (1990-1998), 2% per year. Data for the years 1999, 2002 and 2003 refer to the annual registries data. The years 2000 and 2001 refer to estimates based on the interpolation of 1999 and 2002 data, and the 2004-2007 period to an interpolation of 2003 and 2008 data.



Data from 2008 onwards refer to data collected via SIRER (Integrated System for Electronic Registry on Waste), first in SIRAPA (2008-2011) and, since 2012, in the SILiAMB electronic platform. After data collection and the respective validation at APA, I.P., data is handled by the INE (National Statistical Office) according to the organisation of the information required by the Waste Statistics Regulation (Regulation (EC) no. 2150/2002).

As there is no available information concerning industrial waste treatment for the earlier years, it was assumed that all estimated waste produced have followed the municipal disposal pattern between uncontrolled and controlled SWDS.

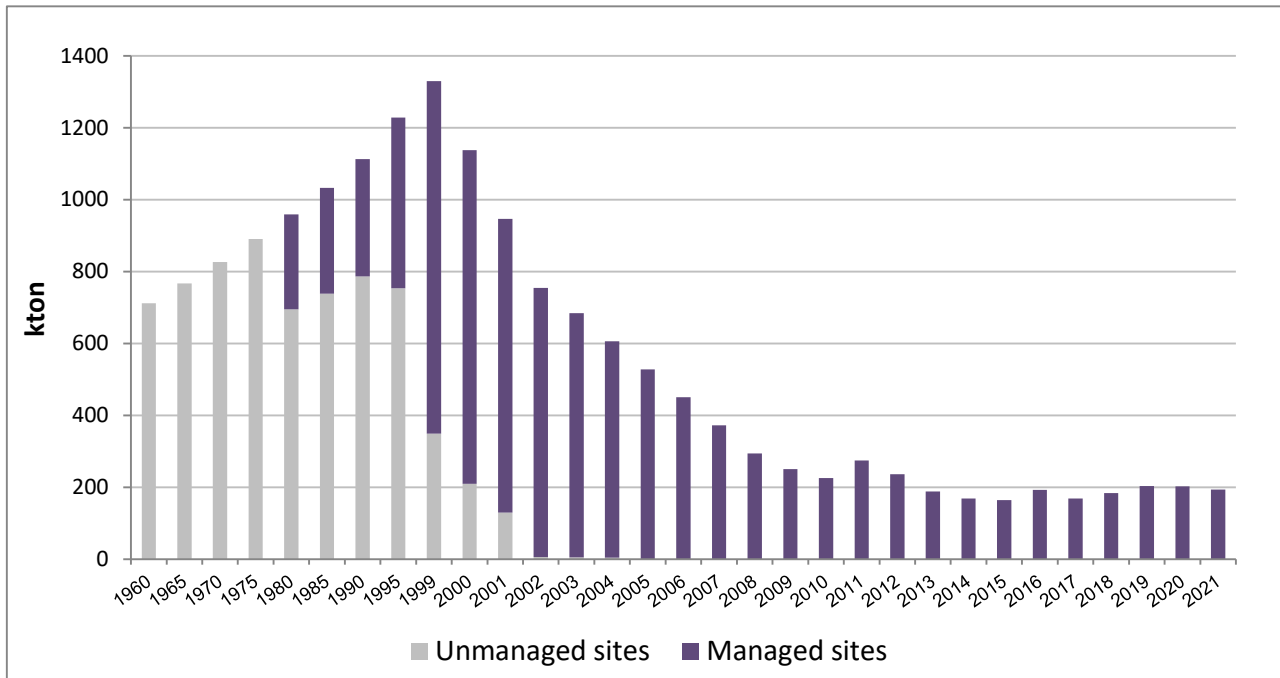

Source: APA

Figure 7-8: Quantities of fermentable industrial waste disposed to SWDS

The fluctuations of industrial waste amounts disposed in landfills, as shown in the figure above, are due among other factors to waste diversion from landfill to other treatment methods or destinations, such as shipping abroad and recycling.

Next figure presents the evolution of all industrial wastes treatment types since 2008. From 2008 to 2021 as the total amount of industrial waste increased from 7.81 Mt in 2008 to 13.63 Mt in 2021, the amount disposed in SWDS decreased from 2.14 Mt in 2008 to 1.33 Mt in 2021 as the recovery of waste increased from 4.69 Mt in 2008 to 11.48 Mt in 2021.

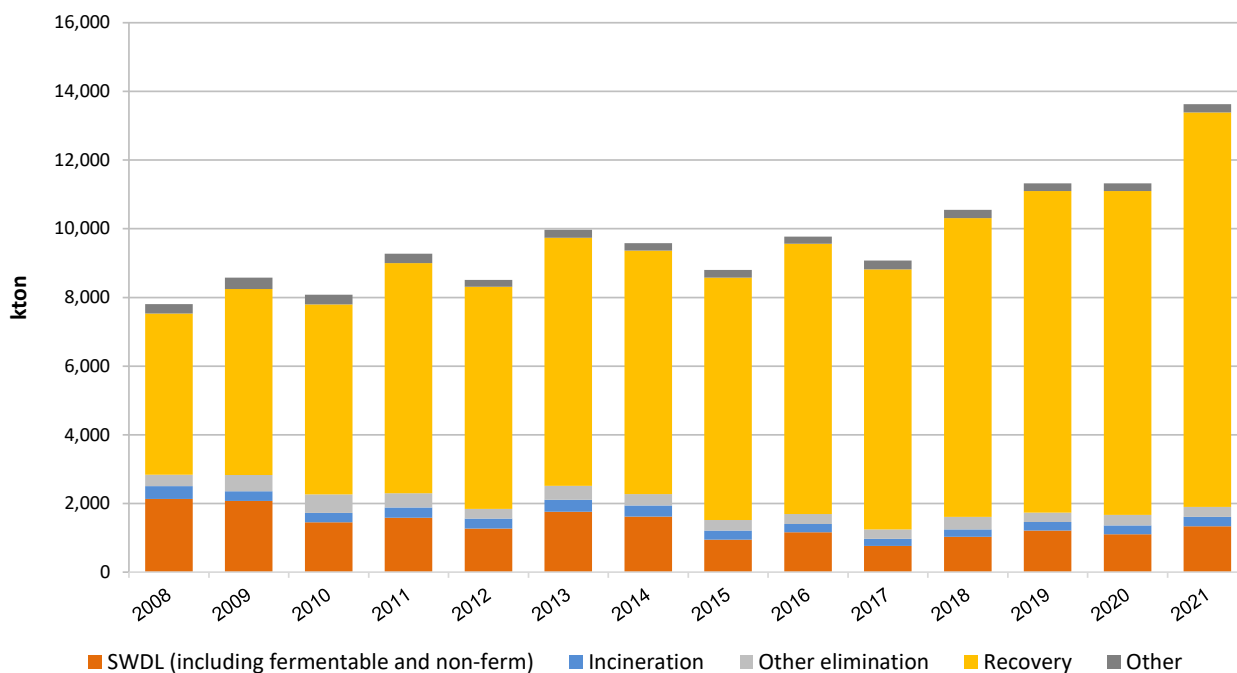

Notes:
Other elimination - includes biological and physio-chemical treatment not specified.
Recovery – includes regeneration, and recycling etc.
Other – storage before other treatments.
Source: APA/INE.

Figure 7-9: Total industrial waste by treatment types

7.2.2.2.3 Waste composition: municipal waste

Waste composition is one of the key parameters that influences the estimation of emissions from SWDS, which depend on the fraction of Degradable Organic Carbon (DOC) in the waste.

Data on waste composition are scarce for the previous years of the time series. Nowadays, data refer to the information collected from all waste management systems, while for the first years data referred to studies which were based in more restricted information. Nevertheless, the first studies included all waste fractions.

The estimation of Degradable Organic Carbon (DOC), presented in the following table, was based on national information on the composition of waste disposed in SWDS.



Table 7-5: Municipal waste composition disposed to SWDS and DOC

Fermentable fractions	DOC content	Early 60s	Early 70s	Early 80s	Early 90s	Mid 90s	2000	2010	2011	2012	2013	2014	2015	2016	2017	2018	2019	2020	2021
		Percentage of wet weight																	
Paper/cardboard	40	17.0	17.0	17.0	21.1	22.7	26.4	13.7	12.9	12.3	13.6	13.7	13.3	10.0	9.4	9.8	7.7	6.3	6.2
Glass	-	2.5	2.5	2.5	4.4	5.1	7.4	3.7	3.6	4.0	4.5	4.4	4.3	3.2	3.2	3.3	3.1	3.3	2.6
Plastics	-	3.0	3.0	3.0	9.2	11.7	11.1	10.8	10.5	10.2	10.8	10.8	10.8	12.5	14.1	14.1	13.5	12.1	11.4
Metal	-	3.0	3.0	3.0	2.8	2.7	2.8	2.0	1.8	1.6	1.9	1.9	1.8	1.6	1.6	1.7	1.5	1.4	1.4
Food waste	15	40.9	40.9	40.9	36.5	34.8	26.5	42.8	43.0	40.9	36.6	37.5	36.7	31.8	30.3	31.6	31.5	32.0	27.2
Textiles	24	5.5	5.5	5.5	3.8	3.1	2.6	6.0	6.4	6.7	7.1	7.4	7.8	8.1	8.1	8.1	8.1	8.1	8.1
Non-food fermentable materials	20	18.7	18.7	18.7	18.7	18.7	17.4	14.3	14.3	14.3	14.3	14.3	14.3	14.6	14.6	14.6	14.6	14.6	14.6
Wood	43	0.3	0.3	0.3	0.3	0.3	0.5	1.5	1.0	1.1	1.1	1.0	1.2	0.7	1.1	0.9	0.9	0.7	0.8
Other	-	9.1	9.1	9.1	3.2	0.9	5.4	5.3	6.5	8.9	10.3	9.1	9.8	17.6	17.7	15.9	19.1	21.6	27.7
DOC	-	18.1	18.1	18.1	18.7	18.9	18.9	16.8	16.4	16.0	15.9	16.1	16.1	13.9	13.6	13.9	13.0	12.5	11.8

Notes:

Data on waste composition: Early 60s, 70s and 80s data refer to Fernandes, A Pastor (1982), "RSU do Continente - um Guia para Orientação e Inform. Das Autarquias", LNETI. Early 90s: estimates from interpolation. Mid-90s: data refer to 1994; DGA. 2000 and since 2010: APA

DOC content: 2006 IPCC defaults.



7.2.2.2.4 Waste composition: industrial waste

Data on DOC varies according to the available information on industrial waste composition and includes estimates based on interpolation for missing years.

Until 2003 the inventory considered data from the waste registries at a disaggregated level of 6 digits of the European Waste List (LoW) Decision - 2000/532/EC, by treatment/destiny type. Based on these categories, a selection was done in order to consider the categories containing fermentable waste, and each of the categories selected was classified according to a group/DOC value.

Since 2008, data refer to the National Waste Registry that collects data via the SIRER's Integrated Waste Registration Map – MIRR at SIRAPA (2008-2011) and SILiAmb electronic platform (since 2012). Data provided by waste operators under this registry are treated subsequently by the INE (National Statistical Institute).

Both data sets, before 2003 and after 2008, are reported according to the European Waste list (LoW) and refer to substance oriented waste groups. Based on these categories, a selection was done in order to consider the categories containing fermentable waste, and each of the selected categories was classified according to a group/DOC value: paper, textiles, garden and other non-food organic putrescible waste, food waste, wood or straw, etc.

In both data sets, the transposition of the information between the European list of waste (LoW) and the EWC Stat classifications is done according to the stipulated in annex III of the waste statistics regulation (Reg. 849/2010, annex III), and thus consistency is considered to exist among waste groups.

Data presented in Table 7-6: Industrial organic waste composition and DOC, are reported according to EWC-Stat Rev 4 categories, which is a substance oriented waste statistical nomenclature.

The fraction “mixed and undifferentiated materials” refer to Mixed packaging which includes essentially composite packaging and mixed packaging, respectively, category 15 01 05 and 15 01 06 of the European list of waste (LoW). The DOC value was established considering equal proportions for each of these waste sub-types, and assuming the average composition (percentage of weight) for composite packaging as: 75% cardboard, 20% polyethylene and 5% aluminium (<http://www.protegeoqueebom.pt/2010/02/18/embalagens-de-cartao-para-liquidos/>); and mixed packaging as 20% for each fraction: paper, glass, plastic, metal and wood.

For the new category “Screening waste”, the DOC value was estimated on the basis of the composition of rejected waste disposed into landfills, considering two thirds of the fractions as inert materials and one third as biogenic.

Total amounts of organic industrial waste and associated DOC values refer to estimates based on interpolation for the years: 2000, 2001 (interpolation of 1999 and 2002 data); and 2004-2007 (interpolation of 2003 and 2008 data). The amounts of waste for the previous decades (1960-1998) were calculated considering annual growth rates as explained previously. Since 2008, data are provided by the waste operators and reported in the National Waste Registry.

DOC values used in the calculations resulted from weighted averages based on the quantities reported for each EWC category considered and the respective assigned DOC, and refer to disposal on land.



Table 7-6: Industrial organic waste composition and DOC

Waste groups (EWC-Stat/Version 4)	DOC (0..1)	Unit	1960-99	1999	2000	2001	2002	2003	2004	2005	2006	2007	2008	2009
			ton											
Health care and biological wastes (05)	0.15	wet waste		98			1	2					7,886	8,586
Paper and cardboard (07.2)	0.40	wet waste		778,422			58,383	278,007					2,320	3,449
Wood (07.5)	0.43	wet waste		155,142			64,044	14,566					20,551	13,947
Textiles (07.6)	0.24	wet waste		63,384			326,329	38,530					30,227	21,777
Waste of food preparation and products (09.1)	0.15	wet waste		19,209			56,455	158,286					14,485	10,604
Garden waste, park waste or other non-food organic putrescibles (09)	0.20	wet waste		77,269			208,965	172,135					22,441	6,782
Household and similar wastes (10.1)	0.18	wet waste		-			-	-					70,432	63,690
Mixed and undifferentiated materials (10.21, 10.22)	0.23	wet waste		-			-	-					17,736	16,444
Screening waste (10.3)	0.11	wet waste		-			-	-					6	14
Sludge (03.2, 03.3, 11)	0.13	wet waste		236,280			39,759	22,687					107,577	105,235
Total fermentable waste disposed on land	-		<i>estimates</i>	1,329,803	1,137,848	945,893	753,937	684,214	606,103	527,993	449,882	371,772	293,661	250,527
DOC (weighted average)	-			0.332	0.332	0.303	0.274	0.245	0.274	0.257	0.240	0.223	0.205	0.188

Waste groups (EWC-Stat/Version 4)	DOC (0..1)	Unit	2010	2011	2012	2013	2014	2015	2016	2017	2018	2019	2020	2021
			ton											
Health care and biological wastes (05)	0.15	wet waste	9,605	10,702	27,109	3,882	813	656	486	495	94	90	91	667
Paper and cardboard (07.2)	0.40	wet waste	1,325	1,178	797	385	314	206	349	287	300	284	337	231
Wood (07.5)	0.43	wet waste	6,965	5,326	3,394	1,190	593	869	1,003	3,273	4,037	2,864	1,361	2,080
Textiles (07.6)	0.24	wet waste	23,218	21,022	14,708	14,288	13,609	12,156	14,618	12,939	14,790	18,299	14,353	13,375
Waste of food preparation and products (09.1)	0.15	wet waste	9,788	8,887	11,186	10,320	10,871	5,919	4,860	3,464	4,291	4,036	5,386	4,378
Garden waste, park waste or other non-food organic putrescibles (09)	0.20	wet waste	6,127	10,349	6,035	3,601	4,615	6,980	4,138	3,909	4,631	5,508	7,313	5,738
Household and similar wastes (10.1)	0.18	wet waste	43,978	96,329	49,762	35,743	32,135	29,435	26,085	30,682	36,906	40,151	46,378	45,172
Mixed and undifferentiated materials (10.21, 10.22)	0.23	wet waste	16,644	15,563	10,639	10,108	10,513	10,836	11,235	11,099	17,408	27,544	24,741	27,704
Screening waste (10.3)	0.11	wet waste	0	0	336	3,579	99	382	368	278	709	1,010	430	93
Sludge (03.2, 03.3, 11)	0.13	wet waste	107,934	104,565	111,771	104,594	92,752	96,621	127,717	102,307	100,284	103,190	101,747	93,811
Total fermentable waste disposed on land	-		225,583	273,921	235,735	187,689	166,314	164,059	190,858	168,734	183,448	202,976	202,136	193,248
DOC (weighted average)	-		0.171	0.171	0.160	0.156	0.157	0.157	0.152	0.160	0.165	0.168	0.165	0.168

Notes:

a) DOC values: IPCC 2006.

b) Data on italics: estimates. Emission factors and other parameters

Other parameters used in the calculation rely on some IPCC default values, and apply both to municipal and industrial waste.

Table 7-7: Parameters used in Lo calculation

Parameter	Explanation	Value considered
MCF	IPCC defaults	Managed landfills = 1.0 Unmanaged/Uncategorised = 0.6
DOCF	2006 IPCC default (including lignin C)	0.5
F	2006 IPCC default	0.5

7.2.2.2.5 Methane generation rate constant (k)

The value of landfill gas generation rate constant (k) depends on several factors as the composition of the waste and the conditions of the SWDS (e.g. climatic conditions).

This parameter is related to the time taken for the DOC_m (Degradable Organic Matter) in waste to decay to half its initial mass ('half life' or t_{1/2}) as follows: $k = \ln 2 / t_{1/2}$. The k value considered was 0.07 (half life of about 10 years), which represents a higher decay rate compared to the k default value proposed by the IPCC 2000 (0.05 - half life of about 14 years).

The k value used was estimated as a function of the national climatic conditions, using a Geographic Information System. A geographic database with the universe Landfill Sites (SWDS) licensed in Portugal was crossed with cartography on the following climatological variables: a) Annual Potential Evapotranspiration (PET); 2) Mean Annual Temperature (MAT); 3) Mean Annual Precipitation (MAP) (from IPMA). Each SWDS was classified according to the climatic conditions and a corresponding k value, based on the recommended default methane generation rate (k) values from 2006 IPCC (Table 3.3, Chapter 3: SWD). The figure below presents the geographical location of landfill sites and their climatological conditions, considered as dry or wet, on the basis of the MAP/PET index.



The 0.07 refers to the average conditions of the overall SWDS.



Figure 7-10: Geographical location of Landfills and climatic conditions

7.2.2.2.6 Landfill gas recovered (R)

Data on landfill gas recovered and combusted is flared or used for energy purposes. The first quantities of biogas consumed for energy purposes reported by DGEG (the national energy authority) refer to 2004. This situation is related to the fact that the great majority of landfills have been implemented in the late 90s or the early 2000s. However, flaring (without energy recovery) started before. In order to account with this practice, the APA launched a questionnaire in 2012 with the aim of collecting the total amount of landfill gas combusted either in flaring (without energy recovery) or used for energy purposes. This inquiry was focused on the more recent years (since 2005) in order not to overload the waste systems managers.

As regards the coverage of the APA's questionnaire, it considered all Municipal SWDS, which totalled in 2012, 34 landfill sites in exploration (receiving waste) in Mainland, plus 3 closed landfill sites which do not receive waste anymore (but burn biogas).



Since 2015, data on biogas is collected from management systems in a specific form included in MRRU (Municipal Waste Registration Form), at APA, I.P.

At present there are 32 MSW landfills in exploration in Mainland, 26 of which use biogas for energy recover. In the two Autonomous Regions there are 6 landfills in exploration (4 in the Azores, and 2 in Madeira (1 of them for emergency situations)).

CH₄ recovered in flares and valorised for energy purposes is estimated on the basis of average biogas flows (continuous measurement) and the number of hours of burning. The concentration of CH₄ in biogas used in the estimates of the CH₄ quantities refer to monitoring plans (quarterly measurements) measuring the biogas quality (generally CH₄, CO₂, O₂, N₂, H₂S) at the entrance of the flares or the biogas energy recovery system.

The annual quantities of biogas burnt (in flares and energy recovering units) reported by each landfill (in cubic meters) were converted into CH₄ amounts considering the CH₄ percentages in biogas (based on measurements) reported by management systems.

Table 7-8: CH₄ in landfill gas

		2004	2005	2006	2007	2008	2009	2010	2011	2012
Average share of CH ₄	%	54	51	53	52	52	52	54	51	50
		2013	2014	2015	2016	2017	2018	2019	2020	2021
Average share of CH ₄	%	50	49	48	52	51	51	48	48	48

Source: APA.

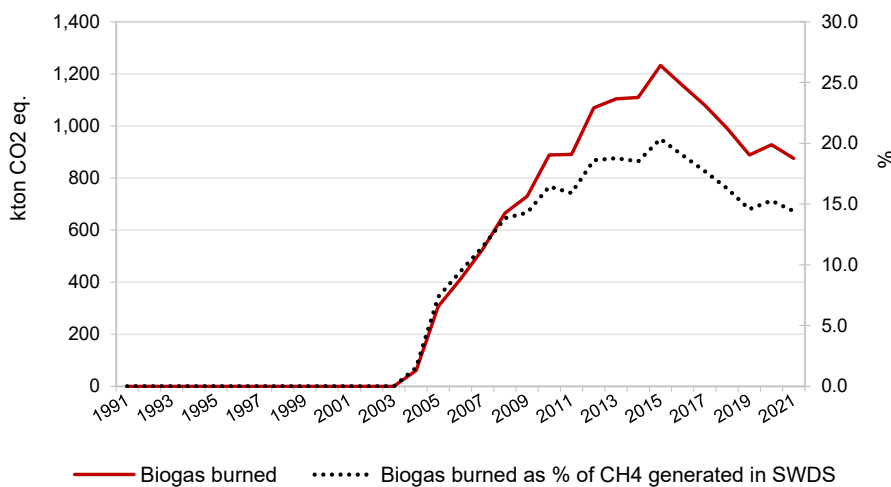

Source: APA and DGEG data.

Figure 7-11: Quantities of CH₄ combusted (SWDS)

The fraction of methane in landfill gas (F) value used was based in the IPCC (0.5) default for the whole time series. Data presented in Table 7.6 refer exclusively to landfill sites that burnt biogas for energy purposes or flaring and do not probably represent the whole landfill sites situations. Figures reported in Table 7.6 are weighted averages calculated from data reported by landfills that were used in the calculation of the CH₄ amounts recovered/burnt.

In what concerns the oxidation factor (OX), the IPCC default value – zero - was used for unmanaged SWDS. For landfill sites, which are considered as well-managed SWDS, it was used 0.1 for OX, as recommended in GPG (IPCC, 2006). The OX factor was applied after subtraction of CH₄ recovered.



7.2.3 Uncertainty assessment

7.2.3.1 Municipal Solid Wastes

The uncertainty of activity data for Municipal Solid Wastes is considered high for past years as data was estimated for each year from population and per capita waste production ratio and mostly because of the low accuracy in the back cast establishment of past solid wastes disposal since 1960. The situation changed in more recent years, where data refer to data collected by waste management systems. Different uncertainty values were considered for different periods applying equation 3.2; $AD = MSWT$ (Total Municipal Solid Waste produced) * $MSWF$ (Fraction of MSWT sent to SWDS), using the proposed values from IPCC 2006. A combined uncertainty of 14% was estimated for the quantities disposed in managed SWDS in 2021. The uncertainty of the emission factor was estimated using a combination of equation 3.2 and 3.1. The default values proposed IPCC 2006 were used to calculate uncertainties for each parameter: DOC (approx. 15%), DOCF (20%), MCF (10%), F (5%) and k (28.6%). An overall error of 25 % was estimated for CH₄ EF in 2021.

7.2.3.2 Industrial Wastes

The activity data for the calculation of emissions from Industrial Waste Production has a lower accuracy than Municipal Solid Wastes, because the time trend since 1960 was established with poor information only collected after 1999. The uncertainty considered in 2021 for the deposition on land of industrial solid wastes was about 18%.

Uncertainty in the determination of the emission factor follows the rules of error propagation and were set from the default values proposed in the 2006 IPCC. The calculated uncertainties in 2021 for the parameters are: DOC (29%), DOCF (20%), MCF (10%), F (5%) and k (28.6%). An overall error of 43 % was estimated for CH₄ EF in 2021.

7.2.4 Category specific QA/QC and verification

7.2.4.1 General QC 1

General QC 1 procedures were applied following the guidance from 2006 IPCC Guidelines (Volume 1/Table 6.1) in particular:

- Checks on data units, calculation procedures, and file links;
- Check for consistency in data between source categories;
- Verification of uncertainties estimates;
- Undertake completeness checks;
- Comparison of estimates to previous estimates.
- An analysis of emission trends and of IEF was performed to detect unusual trends in order to identify potential underlying problems.

7.2.4.2 QC2 procedures

Activity level parameters were compared with 2006 IPCC Guidelines default values.

National emission rates and implied emissions factors (IEF) were compared with other countries, in particular those with similar natural, demographic and economic conditions.



7.2.5 Category specific recalculations

Changes in this submission refer to:

- Solid Waste Deposited on Land (5.A.1)

CH₄ emissions: revision of activity data on MSW deposited on land: 2016-2020; revision of activity data on industrial waste deposited on land: 2020.

7.2.6 Category specific planned improvements

Identification of additional expertise to support the assumptions used to estimate the industrial waste time series for 1960–1998, and to reassess the time-series consistency.



7.3 Biological Treatment of Solid Waste (CRF 5.B)

7.3.1 Category description

This category refers to composting and anaerobic digestion of municipal organic waste. Furthermore, this submission includes, for the first time, composting of non-MSW (e.g. industrial organic waste, forest and garden waste, biogenic sludge from WWT).

The emissions from home composting are not included, as no reliable data exists on this activity.

After the period 1995-2002, characterized by a significant increase in MSW deposition capacity in landfills and incineration with energy recovery, the country has been investing in organic recovery infrastructures (Municipal Waste Management Systems – SGRU) to meet the objectives of the Directive Landfills. In 2002 there were 5 composting units, while in 2021, the number rose to 24 organic recovery units distributed throughout the country. Out of these, 19 units refer to mechanical and biological treatment and 5 to recovery organic units (biological treatment infrastructures for waste from selective collection).

Facilities with a capacity exceeding 75 tons/day for biological treatment activity (composting) (category 5.3 b) i) of Annex I) are covered by the regime of industrial emissions applicable to the prevention and integrated control of pollution (IPCC), established by the Decree-Law No. 127/2013, of 30 August. The inventory included for the first time in this submission the information reported under this regime from 6 facilities.

Anaerobic digestion started in 2006.

The table below presents the estimates of CH₄ emission from the biological treatment of solid waste.

Table 7-9: Emissions from Biological Treatment of Solid Waste (ktCO₂e)

Source	1990	2000	2005	2010	2015	2019	2020	2021
CH ₄	5.6	15.4	14.6	24.8	39.5	94.8	69.4	88.2
N ₂ O	3.2	8.7	8.3	13.9	19.9	47.2	34.1	43.5
Total	8.8	24.1	23.0	38.8	59.4	142.1	103.5	131.7

Note: Totals may not sum due to independent rounding

The source category Biological Treatment has been identified as a key category for CH₄, both in terms of level and trend.

Table 7-10: Calculation methods and types of emission factors for emissions on Solid Waste Disposal on Land

Source	Emissions reported	Methods	Activity Data	Emission Factors
5.B Biological treat. of solid waste	CH ₄	Tier 1	National data	D

7.3.2 Methodological issues

7.3.2.1 Methods

The emissions were estimated using the IPCC default (Tier 1) methodology (IPCC 2006), which is the product of the mass of organic waste treated by biological treatment and an emission factor. When CH₄ recovery occurs the amounts should be subtracted. As the CH₄ emission factor used for anaerobic digestion refer to the IPCC defaults which account for CH₄ recovery, the estimates do not consider biogas recovery in biological treatment systems (anaerobic digestion).

Due to lack of data, in particular for the years until 2008, some assumptions were made in order to estimate the amounts that are effectively subject to composting, i.e. the quantities that are forwarded to biological



treatment minus the amounts rejected afterwards. For the latest years, the rejections from composting represent approximately 55% of the total quantities sent to composting. This percentage was used to estimate the activity level for the past years. Data for the latest years refer to data collected from management systems, which separates entrances and rejections from biological treatment. The time series shown in the next figure presents some fluctuations which are the result of systems functioning interruptions what occurred for instance in 2002, when a composting system did not functioned in that year.

7.3.2.2 Activity Data

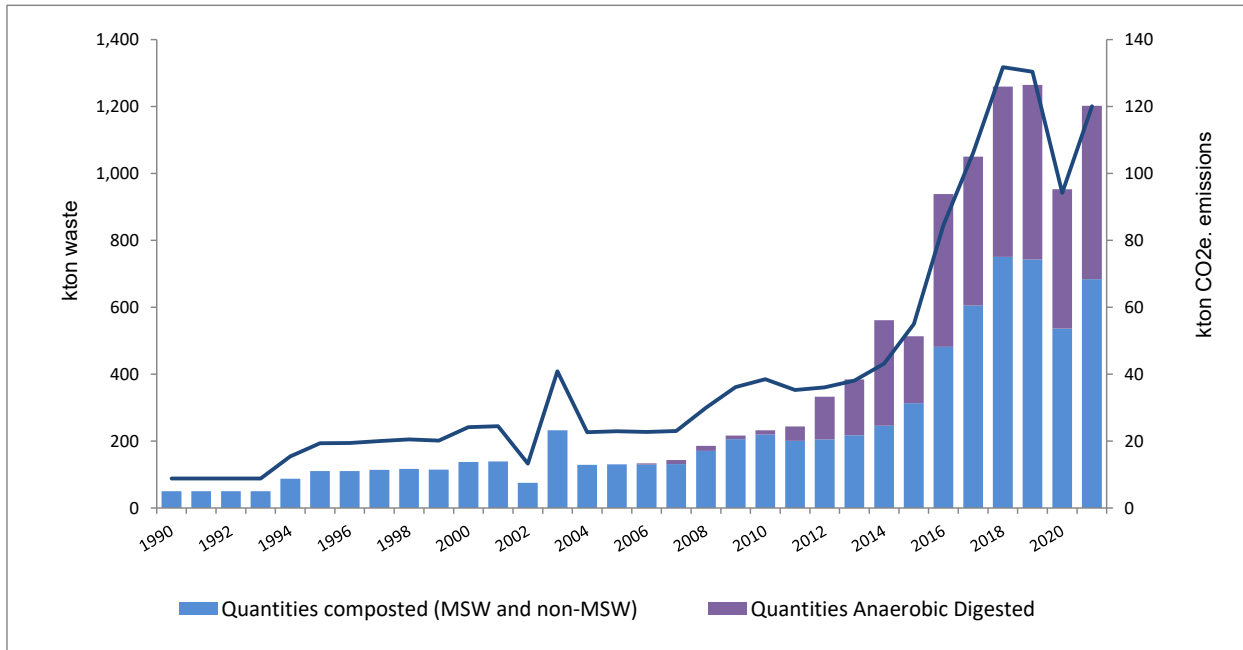

Figure 7-12: Quantities of waste Composted/ Digested and related emissions

7.3.2.3 Emission Factors

Table 7-11: Default emission factors for CH4 and N2O emissions from biological treatment (wet weight basis)

	CH4	N2O
	(g/kg waste treated)	(g/kg waste treated)
Composting	4	0.24
Anaerobic digestion	0.8	Assumed negligible

Source: 2015 corrigenda of the IPCC 2006 GL (IPCC TFI, 31 July 2015 as published at <http://www.ipcc-nggip.iges.or.jp/public/2006gl/index.html>).

7.3.3 Uncertainty assessment

The accuracy of the activity data on biological treatment of waste is considered to be lower for the previous years of the time series when information on waste collection and disposal was scarce. Even for the more recent years, there is still some uncertainty concerning the quantification of the amounts that are effectively subject to composting. In fact, there are considerable amounts of waste that are rejected after being forwarded to organic valorisation facilities. These amounts are well known for the latest years but information is difficult to obtain for previous years. The uncertainties estimated for the activity data varies from approx. 150% (1990) to 14% (2021). The uncertainties of the emissions factors were based on range variations considered in the 2006 IPCC for default emission factors for composting and anaerobic digestion, resulting in 109% for CH4. The uncertainty value considered for EF for N2O emissions from composting is 112.5%.



7.3.4 Category specific QA/QC and verification

QA/QC procedures included a series of checks: calculation formulas verification, data and parameters verification, and the information provided in this report.

7.3.5 Category specific recalculations

Composting (5.B.1)/ CH₄ and N₂O emissions: revision of activity data for the years 2013-2020. This included the accounting of non-municipal organic and garden and park waste quantities not previously considered.

Anaerobic Digestion (5.B.2) / CH₄ emissions: revision of activity data for the years 2016-2020.

7.3.6 Category specific planned improvements

No revisions are foreseen in the near future.



7.4 Waste Incineration (CRF 5.C)

7.4.1 Category description

Waste incineration in Portugal includes combustion of municipal, healthcare and industrial wastes.

Relevant gases emitted include CO₂, CH₄ and N₂O. CO₂ emissions are dependent to a large extent on the amount of fossil carbon in the waste burned. The non-CO₂ emissions are more dependent on the technology and conditions during the incineration process.

Waste incineration with energy recovery includes municipal incineration units (waste-to-energy facilities) and industrial plants (cement plants).

Incineration of municipal solid waste (MSW) takes place in four modern units where energy is recovered, and thus, according to the IPCC Guidelines, these emissions are accounted for in the energy sector (sub-category 1A1a Public electricity and heat production). Emissions from incineration of industrial waste with energy recovery occurring in some industrial plants (cement units) are reported in Energy sector 1A2.

The incineration of other waste, such as healthcare or industrial waste that occurs without energy recovery, is therefore allocated to the waste sector. Nevertheless, as the methodology applies for both situations (with and without energy recover), in order to avoid a double description, it is presented only once in this sub-section.

Emissions have been estimated for the non-biogenic and biogenic component of the waste. Emissions from the non-biogenic component have been reported under public electricity and heat production – other fuels. Non-CO₂ emissions from the biogenic part are accounted under public electricity and heat production – biomass, and the CO₂ emissions are reported as a memo item from solid biomass use.

Table 7-12: Emissions from Waste Incineration (ktCO₂e)

Source/ Gas	1990	2000	2005	2010	2015	2019	2020	2021
Incineration without energy recovery (CRF 5C)								
Industrial solid wastes	3.4	3.7	12.8	15.8	24.6	26.2	31.1	34.6
CO ₂	2.7	2.6	11.2	15.1	23.9	25.4	30.2	33.9
CH ₄	0.2	0.2	0.3	0.1	0.1	0.2	0.2	0.1
N ₂ O	0.6	0.8	1.3	0.6	0.5	0.7	0.7	0.6
Healthcare waste	3.2	4.7	2.8	0.5	1.5	0.2	2.3	3.5
CO ₂	4.4	2.6	0.4	1.4	0.2	2.1	3.3	3.0
CH ₄	0.1	0.1	0.0	0.0	0.0	0.1	0.1	0.1
N ₂ O	0.2	0.1	0.0	0.1	0.0	0.1	0.1	0.1
Open Burning of Waste/Agriculture residues	4.7	57.5	50.9	47.1	42.3	43.1	44.8	45.1
CH ₄	37.7	33.4	30.9	27.7	28.3	29.4	29.6	29.7
N ₂ O	19.8	17.5	16.2	14.5	14.8	15.4	15.5	15.6
Total	7.1	5.2	11.6	16.5	24.2	27.5	33.5	36.9
CH ₄	38.0	33.7	31.3	27.9	28.4	29.7	29.8	29.9
N ₂ O	20.5	18.4	17.5	15.1	15.3	16.2	16.3	16.2
Total	All gases	65.6	57.3	60.4	59.5	67.9	73.3	83.1
MSW incineration (CRF 1A1a)								
	-	308.9	358.4	370.3	446.4	482.5	491.5	434.3
CO ₂ : Non-biogenic	-	290.9	337.5	348.7	424.1	458.9	468.8	409.7
CO ₂ : Biogenic (memorandum item)	-	504.8	585.6	605.1	624.8	602.6	595.7	607.8
CH ₄	-	6.0	6.9	7.2	7.4	7.8	7.5	8.2
N ₂ O	-	12.1	14.0	14.5	15.0	15.8	15.2	16.5



The source category has been identified as a key category for CO₂, in terms of level.

Table 7-13: Calculation methods and types of emission factors for emissions on Solid Waste Disposal on Land

Source	Emissions reported	Methods	Activity Data	Emission Factors
5.C Incineration and open burning of waste	CH ₄	Tier 2a	National data	D

7.4.2 Methodological issues

7.4.2.1 CO₂ emissions

7.4.2.1.1 Methods

CO₂ emissions from waste incineration have been estimated using Tier 2a which requires the use of country-specific data on waste composition and default data on other parameters (equation 5.2 from 2006 IPCC).

For MSW and industrial waste incineration, CO₂ emissions were calculated on the basis of waste composition as following:

Equation 7-1: CO₂ emissions from MSW and industrial waste incineration

$$\text{CO}_2 \text{ emissions (Gg/yr)} = \text{MSW} * \sum_j (\text{WF}_j * \text{dm}_j * \text{CF}_j * \text{FCF}_j * \text{OF}_j) * 44 / 12)$$

Where:

- j - component of the MSW incinerated (such as paper, wood, plastics);
- MSW - total amount of municipal solid waste as wet weight incinerated (Gg/yr);
- WF_j - fraction of waste type/material of component j in the MSW (as wet weight incinerated);
- dm_j - dry matter content in the component j of the MSW incinerated, (fraction);
- CF_j - Fraction of carbon in the dry matter (i.e., carbon content) of component j;
- FCF_j - Fraction of fossil carbon in the total carbon of component j;
- OF_j - oxidation factor, (fraction);
- 44/12 = conversion factor from C to CO₂.

For healthcare wastes, the method applied is based on the total amount of waste combusted (based on equation 5.1 from 2006 IPCC), as follows:

Equation 7-2: CO₂ emissions from healthcare waste incineration

$$\text{CO}_2 \text{ emissions (Gg/yr)} = (\text{SW} * \text{CF} * \text{FCF} * \text{OF} * 44 / 12)$$

Where:

- SW - amount of waste incinerated (Gg/yr);
- CF - fraction of carbon content;
- FCF - fraction of fossil carbon;
- OF – oxidation factor (fraction).



7.4.2.1.2 Activity data, emission factors and other parameters

7.4.2.1.2.1 Municipal Solid Waste

In 1999, two incineration units, Valorsul and Lipor started to operate in an experimental regime, respectively in April and August 1999. Their industrial exploration started at the end of the same year or early January 2000. In 2001/2002, another unit started operating in the Autonomous regions of Madeira, and more recently, at the end of 2015, one more in the Autonomous Region of Azores. These units are dedicated to the incineration of MSW which includes domestic and commercial waste.

All the incineration units considered are modern units using best available technologies, either concerning the abatement technologies or the incineration techniques used, which aim at the optimization of the combustion process, and consequently the minimisation of atmospheric pollutants.

The incineration process used refers to continuous mass burning with heat recovery for steam and electricity production. The waste is burnt in a combustion grate at approximately 1000°C. During the waste incineration process, high temperature gases are released. These gases remain at least 2 seconds in the combustion chambers at a minimum temperature of 850°C. After the passage in the recovery boiler, the produced steam is used for electric power generation; the cooled gases suffer several treatment processes to remove NO_x, acid gases, dioxins, furans, heavy metals and particulates.

Abatement technologies used include:

- NO_x reduction system based on the ammonia or urea injection in the combustion chamber;
- semi-dry treatment process, consisting of a reactor, where spray fine droplets of an alkaline reagent (calcium hydroxide) are introduced to neutralise the acid gases;
- activated carbon injection to remove dioxins, furans and heavy metals;
- fabric filter for particulate removal.
- Emissions associated with the components of fossil origin – plastics, synthetic fibres, and synthetic rubber – are accounted for in the net emissions, which include also the non-CO₂ emissions from the combustion of organic materials (e.g. food waste, paper). CO₂ emissions from the biogenic component are only reported as a memo item.

2006 IPCC considers good practice to make a distinction between composition of waste incinerated and the composition of waste delivered to other waste management systems. Accordingly, CO₂ emissions estimates consider the composition of waste incinerated.

The fossil C content in MSW was calculated from the weighted average of the C content in plastics and textiles (fossil carbon) and the respective fractions of incinerated waste weight. The total C content of MSW, which includes the biogenic and non-biogenic (fossil) components, results from the weighted average of the different waste fractions and the respective total C content. The % of fossil carbon in waste was then obtained dividing the fossil C component by the total C content in MSW.

Information used for the calculation is presented in the table below.

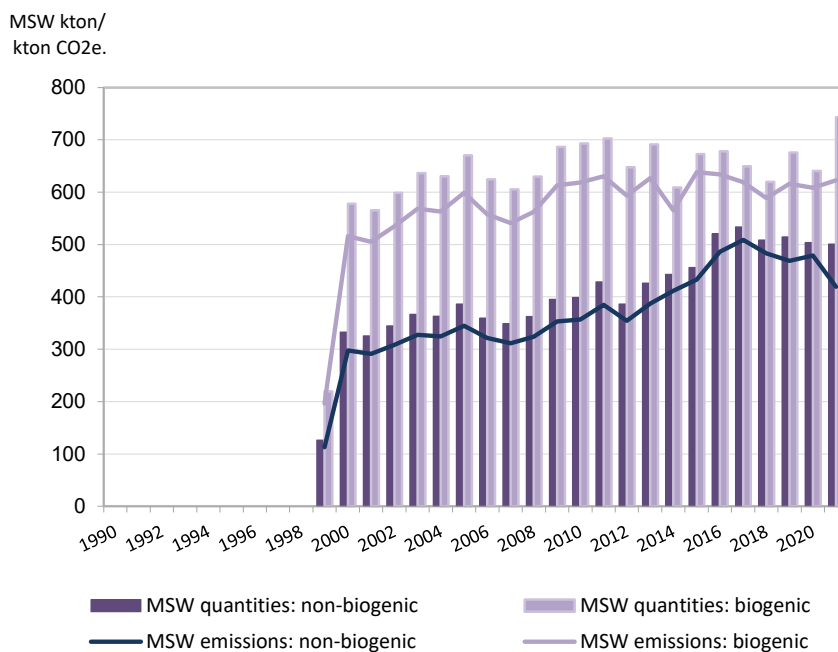

Table 7-14: Base table for MSW C content estimation

	Dry matter content	Carbon content	Fossil carbon	Waste composition (% of wet weight)						
	(% of wet weight)	(% of dry matter)	(% of total C)	< 1999	1999	2000	2010	2011	2012	2013
Paper/ Card	90	46	1	-	14.3	14.3	14.3	15.6	15.6	14.5
Glass	100	NA	NA	-	4.7	4.7	4.7	5.7	5.7	5.1
Plastics	100	75	100	-	10.0	10.0	10.0	10.7	10.7	10.7
Metals	100	NA	NA	-	2.0	2.0	2.0	1.9	1.9	1.8
Food waste	40	38	-	-	42.2	42.2	42.2	39.6	39.6	40.5
Textiles	80	50	20	-	7.9	7.9	7.9	6.1	7.5	7.9
Non-food fermentable materials	40	49	0	-	0.0	0.0	0.0	0.0	0.0	0.0
Wood	85	50	-	-	0.7	0.7	0.7	1.1	1.1	0.8
Other	90	3	100	-	18.1	18.1	18.1	19.3	17.9	18.7
C content in Plastics, Textiles, etc (1)					8.7	8.7	8.7	9.1	9.1	9.2
Total C of waste (2)	-	-	-	-	23.8	23.8	23.8	23.9	24.4	24.2
% non-biogenic C in waste (1)/(2) * 100	-	-	-	-	36.6	36.6	36.6	37.9	37.4	38.2

	Dry matter content	Carbon content	Fossil carbon	Waste composition (% of wet weight)								
	(% of wet weight)	(% of dry matter)	(% of total C)	2014	2015	2016	2017	2018	2019	2020	2021	
Paper/ Card	90	46	1	13.6	15.3	13.0	14.0	13.0	12.0	13.4	9.7	
Glass	100	NA	NA	5.1	5.1	4.5	4.3	3.9	4.0	4.5	4.2	
Plastics	100	75	100	12.3	12.1	12.8	13.6	13.5	12.3	13.2	10.2	
Metals	100	NA	NA	2.1	2.1	1.9	2.4	2.1	2.1	2.3	1.9	
Food waste	40	38	-	38.8	39.7	38.3	35.6	36.5	37.0	37.1	40.6	
Textiles	80	50	20	8.2	8.2	8.2	8.2	8.2	8.2	8.2	8.2	
Non-food fermentable materials	40	49	0	0.0	0.0	0.0	0.0	0.0	0.0	0.0	0.0	
Wood	85	50	-	0.5	0.4	0.7	0.5	1.0	1.5	1.0	1.2	
Other	90	3	100	19.4	17.2	20.5	21.5	21.8	22.9	20.2	23.9	
C content in Plastics, Textiles, etc (1)				10.4	10.2	10.8	11.5	11.4	10.5	11.2	9.0	
Total C of waste (2)	-	-	-	24.8	25.3	24.9	25.5	25.4	24.3	25.4	22.3	
% non-biogenic C in waste (1)/(2) * 100	-	-	-	42.1	40.4	43.4	45.1	45.1	43.2	44.0	40.3	

The emissions from MSW incineration occur with energy recovery and are therefore accounted in the energy sector (category 1A1a).



Source: APA

Figure 7-13: Incineration of Municipal Solid Waste: quantities incinerated (kt) and related emissions (kt CO2e) (accounted in CRF 1Aa)



The emissions result from the combustion of two fuel types: biogenic and non-biogenic, which are reported, in CRF Table 1.A(a), respectively as “Biomass” and “Other Fossil Fuels”. In the case of “Biomass”, emissions refer to combustion in Electricity Production units, Municipal waste incineration and Biogas burning. For “Other Fossil Fuels”, the emissions refer exclusively to Municipal waste incineration.

Table 7-15: CO2 Implied Emission Factors for CRF 1Aa

	Biomass					Other Fuels				
	Energy (GJ)		CO2 emissions (kt)		CO2 IEF (t/TJ)	Energy (GJ)		CO2 emissions (kt)		CO2 IEF (t/TJ)
	Elect.Ind.	MSW and Biogas comb	Elect.Ind.	MSW and Biogas comb		Elect.Ind.	MSW and Biogas comb	Elect.Ind.	MSW and Biogas comb	
1990	-	-	-	-	-	-	-	-	-	-
1991	-	-	-	-	-	-	-	-	-	-
1992	-	-	-	-	-	-	-	-	-	-
1993	-	-	-	-	-	-	-	-	-	-
1994	-	-	-	-	-	-	-	-	-	-
1995	-	-	-	-	-	-	-	-	-	-
1996	-	-	-	-	-	-	-	-	-	-
1997	-	-	-	-	-	-	-	-	-	-
1998	-	-	-	-	-	-	-	-	-	-
1999	85,550	1,718,652	9.6	191.9	111.7	-	990,360	-	110.6	111.7
2000	146,796	4,558,369	16.4	506.9	111.2	-	2,604,809	-	290.9	111.7
2001	316,477	4,451,843	35.4	495.5	111.4	-	2,549,172	-	284.7	111.7
2002	555,142	4,713,200	62.2	524.6	111.4	-	2,698,533	-	301.3	111.7
2003	699,691	5,002,798	78.4	557.3	111.5	-	2,868,620	-	320.3	111.7
2004	746,413	5,078,789	83.6	558.8	110.3	-	2,842,160	-	317.4	111.7
2005	716,680	5,587,014	80.3	604.3	108.6	-	3,021,924	-	337.5	111.7
2006	877,250	5,200,860	98.3	562.7	108.7	-	2,814,102	-	314.3	111.7
2007	896,657	5,272,498	100.4	558.1	106.8	-	2,728,869	-	304.7	111.7
2008	1,883,843	5,713,358	211.0	593.1	105.8	-	2,838,688	-	317.0	111.7
2009	3,970,991	6,339,269	444.8	652.6	106.4	-	3,094,902	-	345.6	111.7
2010	6,769,919	6,679,643	758.2	674.0	106.5	-	3,122,438	-	348.7	111.7
2011	7,127,005	7,164,617	798.2	707.6	105.4	-	3,352,060	-	376.0	112.2
2012	7,116,139	7,116,259	791.7	692.5	104.3	-	3,023,053	-	346.5	114.6
2013	7,239,303	7,739,889	804.2	740.8	103.1	-	3,336,791	-	378.6	113.5
2014	7,775,008	7,336,453	870.2	693.8	103.5	-	3,465,437	-	402.6	116.2
2015	7,693,786	8,244,240	861.7	787.7	103.5	-	3,570,090	-	424.1	118.8
2016	7,242,135	7,925,846	811.1	763.5	103.8	-	4,070,544	-	476.1	117.0
2017	7,196,037	7,820,411	806.0	755.9	104.0	-	4,173,921	-	498.2	119.4
2018	7,729,334	7,446,368	865.7	718.2	104.4	-	3,979,252	-	473.1	118.9
2019	7,543,471	7,809,249	844.9	740.5	103.3	-	4,023,725	-	458.9	114.0
2020	7,352,946	7,589,709	823.5	736.7	104.4	-	3,941,116	-	468.8	118.9
2021	6,787,611	8,529,493	760.2	756.1	99.0	-	3,918,001	-	409.7	104.6

7.4.2.1.2.2 Healthcare waste

Data on healthcare waste incinerated refers to data declared in registry maps of public and private healthcare units (for human and animal), research centers and other units (e.g. piercings, tattoos). The quantities of healthcare waste incinerated decreased strongly in the years 2000 as shown in the previous figure. Twenty-five public incinerators were closed in recent years in Mainland Portugal, and only one healthcare waste incinerator operated from 2004 after suffered two main requalification processes, the most significant occurred in 2004. This infrastructure is nowadays closed.

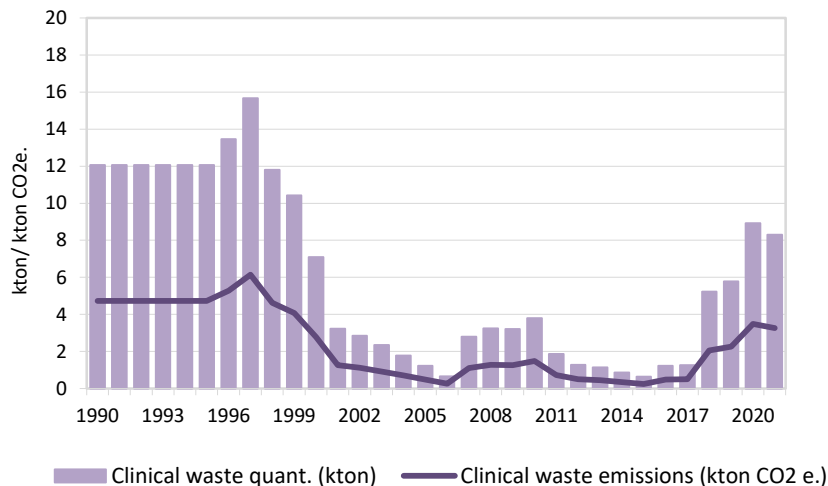

Sources: APA; DGS.

Figure 7-14: Incineration of Healthcare Waste: quantities incinerated (kt) and related emissions (kt CO2e)

Currently, there are two healthcare incinerators in Portugal: the “Centro Integrado de Gestão de Resíduos da Chamusca (CIGR)”, and the “Centro Integrado De Valorização E Tratamento De Resíduos Hospitalares E Industriais (CIVTRH)”. With this two units, Portugal is now able to treat all group IV healthcare wastes, as well as drug residues, animal by-products and other residues that need destruction by incineration.

In the CIVTRHI, the thermic treatment process includes 2 phases. At a first stage, designated as pyrolysis, the waste is burnt in oxygen deficit conditions at temperatures from 650°C to 800°C. The resulting gases get into a second combustion chamber or thermal reactor where the gases suffer a new combustion reaching higher temperatures (minimum 1100°C) during at least 2 seconds. These gases are then conducted into a boiler where they are cooled. After that, the gases suffer a dry treatment chemical process, in a contact reactor, through the direct injection of ammonia, lime and activated carbon in the gas flux. At the end, the gas is conducted into filters where the particulate matter is trapped.

The parameters considered for healthcare waste are presented in the following table.

Table 7-16: Parameters considered: healthcare waste

	Unit	Healthcare waste
C content of waste	%	40 a)
Fossil carbon in waste	% total C	25 a)

Note: a) 2006 IPCC default (wet basis).

The oxidation factor in percentage of carbon input considered is 100% (IPCC default).

7.4.2.1.2.3 Industrial Waste

Data refer to incineration of industrial solid waste in industrial units collected in APA, which includes hazardous and sewage sludge waste. Data for the years 1999, 2002 and 2003 refer to industrial units declarations. Data for the period 1990-98 are based on the same assumptions used for Industrial Solid Waste Disposed on Land: a per year growth rate of 2%. Data for the years 1999, 2002 and 2003 refer to the annual registries data. The years 2000 and 2001 refer to estimates based on the interpolation of 1999 and 2002 data, and the 2004-2007 period to an interpolation of 2003 and 2008 data.



Data from 2008 onwards refer to data collected via SIRER (Integrated System for Electronic Registry on Waste), first (2008-2011) in the SIRAPA platform and since 2012 in the SILiAmb electronic platform. After data collection and the respective validation at APA, I.P., data is handled by the INE (National Statistical Office) in order to extrapolate the information to the universe of enterprises for each economic branch, due to the different scope required by the national legislation on waste registration and the Waste Statistics Regulation (Regulation (EC) no. 2150/2002).

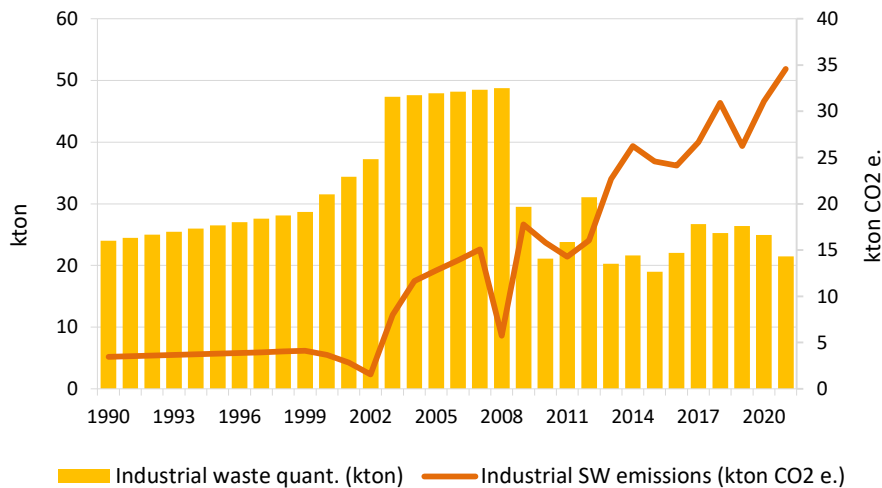

Source: APA (include estimates).

Figure 7-15: Quantities of combusted industrial waste

The significant fluctuations on the amounts of industrial waste incineration, as shown in the previous figure, results, at least partially, from the variation of fluxes to other treatments or destinations (landfilling, export (e.g. hazardous waste) and recycling) as a consequence of the annual waste market demand.

Despite the reduction in quantities of industrial waste incinerated, the emissions raised in more recent years due to the growth of the fossil carbon content fraction of waste incinerated.

Table 7-17: Parameters considered.

	Unit	Industrial Solid Waste									
		1990	1995	2000	2005	2008	2009	2010	2011	2012	
C content of waste	%	0.14	0.14	0.16	0.21	0.21	0.38	0.38	0.34	0.32	
Fraction of fossil carbon in waste	% total C	0.21	0.21	0.14	0.30	0.11	0.41	0.51	0.46	0.42	
Efficiency of combustion a)	%	100	100	100	100	100	100	100	100	100	

	Unit	Industrial Solid Waste									
		2013	2014	2015	2016	2017	2018	2019	2020	2021	
C content of waste	%	0.42	0.44	0.45	0.43	0.42	0.45	0.42	0.45	0.49	
Fraction of fossil carbon in waste	% total C	0.70	0.74	0.76	0.68	0.63	0.73	0.63	0.74	0.88	
Efficiency of combustion a)	%	100	100	100	100	100	100	100	100	100	

Note:

a) IPCC default.



The parameters presented in the previous table (C content and % total C) are national estimates based on the background data on industrial waste production. This information is classified according to the European Waste Catalogue list (EWC) and is disaggregated by treatment type. Each one of the EWC categories were classified according to a group and were assigned with an estimated fraction of C content and a fraction of fossil carbon in waste, which has been defined by expert judgment. The values considered resulted from weighted averages based on quantities reported for each of the EWC categories and the respective assigned C content and fraction of fossil C.

7.4.2.2 Non-CO₂ emissions

Non-CO₂ emissions are dependent in particular on the technology and conditions during the incineration process. The completeness of combustion (temperature, oxygen, residence time) is especially relevant for the CH₄ emissions. The N₂O emissions are mainly determined by technology, combustion temperature and waste composition.

7.4.2.2.1 Methods

Emissions were estimated as the product of the mass of total waste combusted and an emission factor for the pollutant emitted per unit mass of waste incinerated.

Equation 7-3: Non-CO₂ emissions from waste incineration

$$\text{Non-CO}_2 \text{ emissions (Gg/yr)} = \sum_i (IW_i * EF_i) * 10^{-6}$$

Where:

IW_i - amount of incinerated waste of type i (Gg/yr);

EF_i - aggregate pollutant emission factor for waste type i (kg pollutant/Gg);

i – waste type (MSW, Industrial waste, healthcare waste).

7.4.2.2.2 Emission factors

Emission factors applied are either country-specific (Tier 2), being obtained from monitoring data in incineration units, or obtained from references US/AP42 or EMEP/CORINAIR (EEA,2016) (Tier 1).

The CH₄ emission factor considered follows the guidance from 2006 IPCC that says that for continuous incineration of MSW and industrial waste, it is good practice to apply the CH₄ emission factors for Stationary Combustion (Volume 2, Chapter 2).

For N₂O emissions the default emission factor from table 5.6 of volume 5: waste of the 2006 IPCC was used.

Table 7-18: Emissions factors of GHG and precursors gases from incineration of MSW

Pollutants	Unit	EF	Source
LHV	MJ/kg	7.82	PROET study
CH ₄	g/GJ	30.00	2006 IPCC
N ₂ O	kg/ton MSW	0.05	2006 IPCC
SO _x	kg/ton MSW	[0.0152 - 0.0743]	Plant Specific (Monitoring Data)
NO _x	kg/ton MSW	[0.444 - 1.2069]	Plant Specific (Monitoring Data)
COVNM	kg/ton MSW	[0.0006 - 0.0059]	Plant Specific (Monitoring Data); 2016 EEA Guidebook (Tier 1); Nielsen et al. (2010)
CO	kg/ton MSW	[0.0075 - 0.0708]	Plant Specific (Monitoring Data)

**Table 7-19: Emissions factors of GHG and precursors gases from incineration of healthcare wastes: until 2004**

Pollutants	Unit	EF	Source
LHV	MJ/kg W	13.82	Country Study (Environmental Impact Assessment)
CH ₄	g/GJ	30.00	2006 IPCC
N ₂ O	kg/ton W	0.05	2006 IPCC
SO _x	kg/ton W	1.09	2016 EEA Guidebook (Tier 2, Uncontrolled)
NO _x	kg/ton W	1.78	2016 EEA Guidebook (Tier 2, Uncontrolled)
COVNM	kg/ton W	0.70	2016 EEA Guidebook (Tier 2, Uncontrolled)
CO	kg/ton W	1.48	2016 EEA Guidebook (Tier 2, Uncontrolled)

Table 7-20: Emissions factors of GHG and precursors gases from incineration of healthcare wastes: after 2005

Pollutants	Unit	EF	Source
LHV	MJ/kg W	13.82	Country Study (Environmental Impact Assessment)
CH ₄	g/GJ	30.00	2006 IPCC
N ₂ O	kg/ton W	0.05	2006 IPCC
SO _x	kg/ton W	0.09	2016 EEA Guidebook (Tier 2, Controlled by various types of abatement)
NO _x	kg/ton W	1.78	2016 EEA Guidebook (Tier 2, Uncontrolled)
COVNM	kg/ton W	0.70	2016 EEA Guidebook (Tier 2, Uncontrolled)
CO	kg/ton W	1.48	2016 EEA Guidebook (Tier 2, Uncontrolled)

Table 7-21: Emissions factors of GHG and precursors gases for Industrial solid waste incineration

Pollutants	Unit	EF	Source
LHV	MJ/kg	7.82	PROET study
CH ₄	g/GJ	30.00	2006 IPCC
N ₂ O	kg/ton MSW	0.10	Corinair 3rd version. Activity 090201. No NO _x abatement
SO _x	kg/ton MSW	0.05	2016 EEA Guidebook (Tier 1 default EF)
NO _x	kg/ton MSW	0.87	2016 EEA Guidebook (Tier 1 default EF)
NM _V OC	kg/ton MSW	7.40	2016 EEA Guidebook (Tier 1 default EF)
CO	kg/ton MSW	0.07	2016 EEA Guidebook (Tier 1 default EF)

7.4.2.2.2.1 Open Burning of Waste

Following the 2022 NECD review, Portugal reallocated emissions from residues burning of vineyard, olive trees or orchard, previously reported in the agriculture sector, to category 5C2.

In order to avoid repetition, the methodological description of this issue is considered in the category 3F chapter where emissions from in place field burning (e.g. stubble burning) are included.

7.4.3 Uncertainty Assessment

The accuracy of activity data considered for incineration of MSW was 5%. The uncertainty for CO₂ emission factor was estimated on the basis of the value ranges proposed by the 2006 IPCC for the fossil carbon fraction in % of total carbon for the different fractions of waste incinerated. The estimated uncertainty for 2021 resulting from the application of equation 3.2 is 30%.

For healthcare wastes an uncertainty of 30% for the years 1990 and 10% since 2006 was considered for the activity data. For industrial incineration (without energy recovery) an uncertainty of approx. 190% was estimated for the activity data for the early 1990s and 18% for the latest years.

The uncertainty of CO₂ emission factors was set as 10% for hospital wastes and 250% for industrial wastes, which expresses the uncertainty in carbon content and the additional uncertainty in the fraction of the incinerated carbon that has fossil origin. For N₂O and CH₄ emission factors a 100% uncertainty was considered.



7.4.4 Category specific QA/QC and verification

7.4.4.1 General QC 1

General QC 1 procedures were applied following the guidance from the IPCC GPG (IPCC 2000, Table 8.1) in particular:

- Checks on data units, calculation procedures, and data field relationships
- Check for consistency in data between source categories
- Verification of uncertainties estimates
- Undertake completeness checks
- Comparison of estimates to previous estimates.

An analysis of emission trends and of IEF was performed to detect unusual trends in order to identify potential underlying problems.

7.4.4.2 QC2 procedures

National emission rates and implied emissions factors (IEF) were compared with other countries, in particular those with similar natural, demographic and economic conditions.

The AD for waste incineration related to energy production used by the inventory was compared with DGEG energy balance available data. As the next figure shows, the amounts considered in the EB and the inventory do not differ significantly (biggest difference refers to 2014 (-4% in EB data)). As regards the energy content (NCV), the values considered by DGEG are lower than the values considered by the inventory. Data used in the inventory refer to a study done in the past, whereas EB data are annual data from operators.

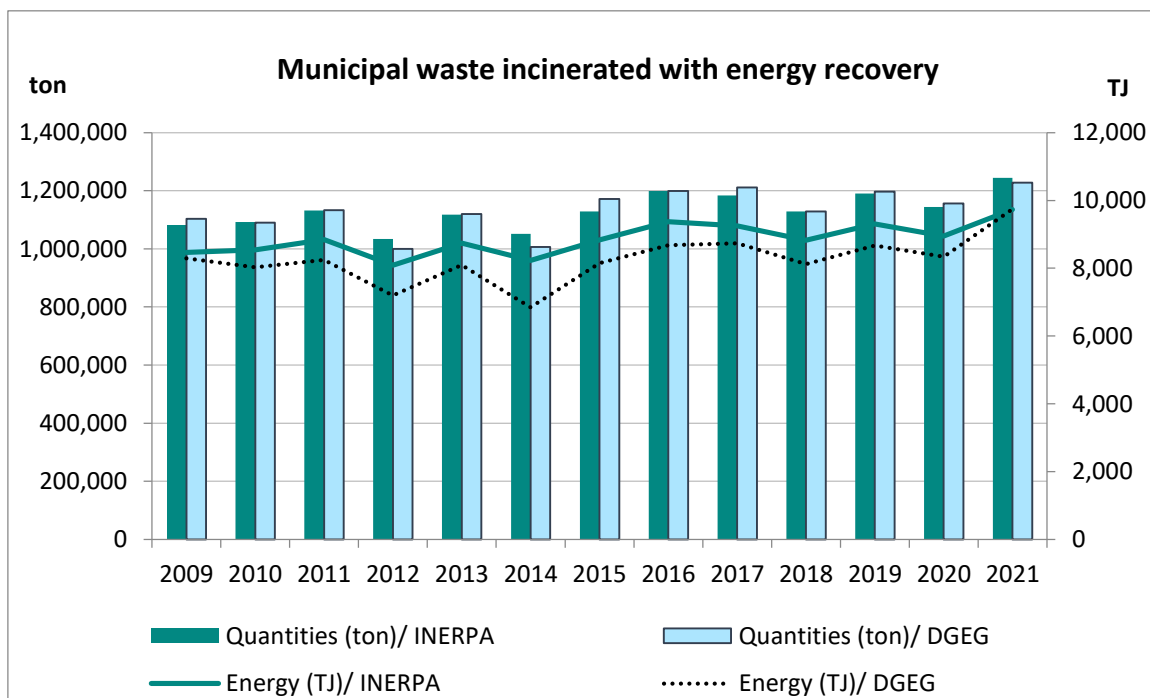

Figure 7-16: Comparison between MSW incineration data used in the inventory and EB data



7.4.5 Category specific recalculations

Changes in this submission refer to:

- Waste Incineration (5.C.1)

Industrial and Clinical waste: activity data update for 2019 and 2020.

- Open Burning of Waste (5.C.2)

CH₄ and N₂O emissions for the whole time series: following the 2022 NECD review, Portugal reallocated emissions from residues burning of vineyard, olive trees or orchard, previously reported in the agriculture sector, to category 5C2. The emissions from in place field burning (e.g. stubble burning) remained in category 3F.

7.4.6 Category specific planned improvements

Revision of the assumptions used to estimate the industrial waste time series for the period 1990–1998.



7.5 Wastewater Treatment and Discharge (CRF 5.D)

7.5.1 Category description

Wastewater treatment processes can produce CH₄ when treated or disposed anaerobically, and N₂O. CO₂ emissions from wastewater are not considered as these are of biogenic origin and should not be included in the national total emissions.

Table 7-22: Calculation methods and types of emission factors for emissions on wastewater treatment and discharge

Source	Emissions reported	Methods	Activity Data	Emission Factors
5.D.1 Domestic wastewater	CH ₄	Tier 2	National data	CS, D
	N ₂ O	Tier 1	National data	D
5.D.2 Industrial wastewater	CH ₄	Tier 2	National data	CS, D

The emissions estimates from wastewater treatment have been decreasing since 1990 as the next table shows. The overall reduction represents 50 per cent in the period 1990-2021.

Table 7-23: Emissions from Wastewater Treatment and Discharge (ktCO₂e)

Gas/Source	1990	2000	2005	2010	2015	2019	2020	2021
CH₄	1,698.8	1,439.1	1,557.0	1,346.7	1,070.0	824.5	777.5	769.1
Domestic wastewater	1,409.2	1,125.3	1,146.3	972.6	673.4	579.9	566.4	558.3
Industrial wastewater	289.6	313.8	410.6	374.2	396.5	244.7	211.1	210.7
N₂O	177.8	213.6	213.8	230.4	161.5	172.0	166.6	168.5
Domestic and Industrial wastewater	177.8	213.6	213.8	230.4	161.5	172.0	166.6	168.5
Total	1,876.7	1,652.7	1,770.7	1,577.1	1,231.4	996.5	944.2	937.6

7.5.2 Methodological issues

7.5.2.1 Domestic Wastewater CH₄ emissions

7.5.2.1.1 Methods

7.5.2.1.1.1 Determination of the total amount of organic material originated in each wastewater handling system

The main factor determining the CH₄ generation potential of wastewater is the amount of degradable organic component (DC) of the wastewater stream, which is expressed in terms of either BOD₅ (recommended for domestic wastewater and sludge), or COD (more appropriate for industrial waste streams). Total organics in wastewater (TOW) is a function of human population and the amount of degradable organic component generated per person.

Equation 7-4: Total organics in wastewater

$$TOW_{dom} = P * D_{dom}$$

Where:

TOW_{dom} - total domestic/commercial organics in wastewater in kg BOD₅/yr;

P - population in 1000 persons;

D_{dom} - domestic/commercial degradable organic component in kg BOD₅/1000 persons/yr.

The fraction of organics treated using wastewater handling system i (TOW_i) is calculated as a percentage of population served by wastewater handling system.

**Equation 7-5: Fraction of organics per wastewater handling system type**

$$TOW_i = (TOW_{dom} * U_i) - S_i$$

Where:

U_i – fraction of population served by each treatment/discharge pathway or system type i ;

S_i – organic component removed as sludge in each treatment system type i .

7.5.2.1.1.2 Estimation of emission factors

The emission factor for each wastewater depends on the maximum CH_4 producing potential of each waste type (B_o) and a weighted average of CH_4 conversion factors (MCF) for the different wastewater treatment systems existing in a country.

Equation 7-6: Emission Factors per wastewater handling system type

$$EF_i = B_o \times MCF_i$$

Where:

EF_i - emission factor (kg CH_4 /kg DC) for wastewater handling system type i ;

B_o - maximum methane producing capacity (kg CH_4 /kg BOD_5);

MCF_i - methane correction factors of each wastewater system i .

Maximum CH_4 producing capacity (B_o) is the maximum amount of CH_4 that can be generated from a given quantity of wastewater.

Methane Correction Factor (MCF) is an estimate of the fraction of DC that will ultimately degrade anaerobically. The MCF varies between 0 for a completely aerobic system to 1.0 for a completely anaerobic system.

7.5.2.1.1.3 Calculation of emissions

Emissions are a function of total organics generated and an emission factor characterizing the extent of CH_4 generation for each wastewater handling system. Total emissions are calculated as the sum of emissions from the different handling systems. CH_4 that is recovered and flared or used for energy should be subtracted from emissions, as it is not emitted into the atmosphere.

Equation 7-7: Total CH_4 emissions from wastewater handling

$$CH_4 \text{ emissions} = \sum_i (TOW_i * EF_i) - R$$

Where:

CH4 emissions - Total CH_4 emissions from wastewater handling in kg CH_4 /yr;

TOW_i - total organics in wastewater for type i in kg BOD_5 /yr. (Step 1);

EF_i - emission factor for waste type i in kg CH_4 /kg DC (Step 2);

R - total amount of methane recovered or flared in kg CH_4 .

7.5.2.1.2 Activity data and parameters

Total organic content of domestic sewage (TOW_{dom}) was determined multiplying the total population for each year by a per capita wastewater BOD_5 production rate. National population data is from the census from National Statistical Office (INE) for the years 1981, 1991, 2001 and 2011, and intermediate years have been estimated by interpolation.



Population data since 2011 refer to estimates also from INE. The BOD₅ factor considered was 60 g BOD₅/cap/day, which is the figure considered in the Council Directive 91/271/CEE, 21st May, referring to urban waste water treatment.

Population served by wastewater handling system

Until the 2018 submission, the accounting of this category was based exclusively on data trends for the public urban wastewater handling systems and types of treatment compiled by APA (previously INAG/ Water Institute which was integrated in the APA), which refer to:

- from 1990 to 1999, data are based on a compilation study, performed by ex-INAG, of all surveys and inventories done in the past concerning sanitation and wastewater treatment infrastructures. Data from this study refer to 1990, 1994 and 1999;
- from 2005 onwards, data is based on a database (INSAAR – “*Inventário Nacional de Sistemas de Abastecimento de Água e de Águas Residuais*”/ National survey on water supply and wastewater treatment systems) which was implemented and was managed by ex-INAG. From 2000 to 2004, data used in the calculations are interpolations based on the 1999 and 2005 figures.

As a consequence of the restructuration of the National Water Authority, the INSAAR, the national data base for water supply and wastewater treatment systems was deactivated and the last available year from this survey is the year 2009. Until the 2018 submission, data used for the period 2010-2016 referred to the latest available year of this survey (2009).

In order to overcome this situation, data on wastewater treatment types for this period was revised, based on new data collected for 2015 from Águas de Portugal (AdP Group) and other main urban wastewater treatment plants (> 50 000 inhab. eq.) information registered by APA.

AdP Group is a Portuguese state-owned company that operates in the water sector. AdP Group companies operates in mainland Portugal and in the fields of water supply and wastewater sanitation, namely the abstraction, treatment and distribution of water for public consumption and the collection, transport, treatment and disposal of urban wastewater. The other main WWTPs (> 50 000 inhab. eq.) are managed by municipal management entities.

AdP’s universe represents approximately 60% of wastewater treatment in Portugal. Together with other large wastewater treatment plants (> 50 000 inhab. eq.) data on wastewater treatment for 2015 is considered to represent around 70% of Portuguese resident population.

For the remaining share of the Portuguese population, two sets of data were considered for wastewater handling system types: one in mainland Portugal and the other referring to the Autonomous Regions of Madeira and Azores.

The next table shows the evolution of the total population by wastewater handling system.

For the period 1990-2009, data corresponds to previous set of data used in the preceding submissions, and thus refers to wastewater sanitation surveys from the National Water Authority.

For the years after 2010, data considered includes the 3 sets of information:

- the AdP’s universe representing, together with other major WW treatment, approximately 70% of population served;
- the Autonomous Regions (islands of Madeira and Azores) which represents around 5% of population;
- other systems in mainland Portugal, amounting for the remaining share of population.



Table 7-24: Percentage of population by wastewater handling system

Wastewater handling systems		1990	1994	1999	2000	2005	2010	2015	2019	2020	2021
		% population									
Population without sewerage		38.5	31.6	21.2	22.3	27.5	21.2	16.1	15.8	15.6	15.6
1.1-	% Pop: without sewerage (latrines)	37.0	23.4	6.4	5.3	0.0	0.0	0.0	0.0	0.0	0.0
1.2-	% Pop: individual treatment (private septic tanks)	1.5	8.2	14.8	16.9	27.5	21.2	16.1	15.8	15.6	15.6
Population with sewerage		43.3	47.4	36.8	31.9	7.5	7.1	1.5	1.5	1.4	1.4
2.1-	% de Pop: with discharge into the ocean, without treatment	6.5	6.5	6.5	5.6	1.0	1.1	0.4	0.4	0.3	0.3
2.2-	% de Pop: with discharge into inland waters, without treatment	36.8	40.8	30.3	25.9	4.0	1.1	0.2	0.2	0.2	0.2
2.3-	% de Pop: with discharge into soil, without treatment	0.0	0.0	0.0	0.0	0.1	0.0	0.0	0.0	0.0	0.0
2.4-	% de Pop: unknown disposal	0.0	0.0	0.0	0.4	2.4	4.9	0.9	0.9	0.9	0.8
3-	% Pop: with treatment	18.2	21.1	42.0	45.8	65.0	71.7	82.4	82.8	83.0	83.0
3.1-	% Pop: colective septic tanks	2.2	2.3	5.0	5.0	5.0	2.7	0.7	0.7	0.7	0.6
3.2-	% Pop: with preliminary treatment	0.0	0.0	0.0	0.5	3.0	6.9	1.8	1.1	1.1	1.1
3.3-	% Pop: with primary treatment	5.2	5.2	9.0	8.5	6.0	2.9	10.1	9.4	9.4	9.4
3.4-	% Pop: with secondary and tertiary treatment	10.8	13.6	28.0	31.8	51.0	59.3	69.7	71.5	71.8	71.9
3.4.1-	Biodisks with anaerobic sludge digestion	1.1	1.4	2.0	1.7	0.2	0.1	0.1	0.1	0.1	0.1
3.4.2-	Biodisks without anaerobic sludge digestion	0.0	0.0	0.0	0.1	0.8	0.2	0.2	0.2	0.2	0.2
3.4.3-	Activated sludge with anaerobic sludge digestion	1.4	2.0	4.6	6.9	18.5	18.3	30.8	30.9	30.8	30.8
3.4.4-	Activated sludge without anaerobic sludge digestion	1.4	2.0	4.6	5.8	11.7	14.4	18.4	18.7	18.9	19.1
3.4.5-	Laguning, with anaerobic pond	1.7	1.9	3.6	3.0	0.2	0.3	0.3	0.3	0.3	0.3
3.4.6-	Laguning, without anaerobic pond	0.6	0.6	1.2	1.9	5.3	4.2	4.2	4.3	4.3	4.3
3.4.7-	Percolation beds with anaerobic sludge digestion	3.6	4.6	8.8	8.0	3.7	2.8	2.5	2.5	2.5	2.5
3.4.8-	Percolation beds without anaerobic sludge digestion	0.0	0.0	0.0	0.7	3.9	1.9	2.5	2.5	2.5	2.5
3.4.9-	Imhoff Tank	0.6	0.3	0.1	0.3	1.3	0.8	0.3	0.3	0.3	0.3
3.4.10-	Oxidation ponds with anaerobic sludge digestion	0.0	0.0	0.0	0.1	0.6	0.6	0.4	0.4	0.4	0.4
3.4.11-	Oxidation ponds without anaerobic sludge digestion	0.3	0.4	1.6	1.6	1.5	1.3	0.6	0.5	0.5	0.6
3.4.12-	Other treatment with anaerobic sludge digestion	0.0	0.0	0.0	0.4	2.3	2.1	0.0	0.0	0.0	0.1
3.4.13-	Other treatment without anaerobic sludge digestion	0.0	0.3	1.6	1.4	0.2	1.4	9.4	10.9	10.9	10.9
3.4.14-	With unspecified treatment	0.0	0.0	0.0	0.1	0.8	10.8	0.0	0.0	0.0	0.0

Source: APA

Sludge is produced in all of the primary, secondary and tertiary stages of treatment. Sludge that is produced in primary treatment consists of solids that are removed from the wastewater and is not accounted in this category.

Total organic waste (TOW in terms of BOD₅ produced) was divided into 3 main fractions (please see next table), according to the information on wastewater handling types and on assumptions (expert judgment) concerning the fraction of the organic load treated as a liquid phase (wastewater) and as sludge according to wastewater handling systems' types, and the fraction retained as non-mineralised with other final destinations.



Table 7-25: Wastewater handling systems and associated fraction of organic load treated as liquid and solid phase

Wastewater handling systems					Share between liquid phase and solid treatment		Sludge accounted in other pathways a)
					Wastewater	Sludge	
					(% of organic load)		
Population without sewerage							
1.1-	% Pop: without sewerage (latrines)				100%	-	-
1.2-	% Pop: individual treatment (private septic tanks)				100%	-	-
Population with sewerage							
2.1-	% de Pop: with discharge into the ocean, without treatment				100%	-	-
2.2-	% de Pop: with discharge into inland waters, without treatment				100%	-	-
2.3-	% de Pop: with discharge into soil, without treatment				100%	-	-
2.4-	% de Pop: unknown disposal				100%	-	-
Population with treatment							
3.1-	% Pop: collective septic tanks				100%	-	-
3.2-	% Pop: with preliminary treatment				-	-	-
3.3-	% Pop: with primary treatment				70%	-	30%
3.4-	% Pop: with secondary and tertiary treatment				-	-	-
3.4.1-	Biodisks with anaerobic sludge digestion				63%	37%	-
3.4.2-	Biodisks without anaerobic sludge digestion				63%	-	37%
3.4.3-	Activated sludge with anaerobic sludge digestion				63%	37%	-
3.4.4-	Activated sludge without anaerobic sludge digestion				63%	-	37%
3.4.5-	Laguning, with anaerobic pond				100%	-	-
3.4.6-	Laguning, without anaerobic pond				63%	-	37%
3.4.7-	Percolation beds with anaerobic sludge digestion				63%	37%	-
3.4.8-	Percolation beds without anaerobic sludge digestion				63%	-	37%
3.4.9-	Imhoff Tank				100%	-	-
3.4.10-	Oxidation ponds with anaerobic sludge digestion				63%	37%	-
3.4.11-	Oxidation ponds without anaerobic sludge digestion				63%	-	37%
3.4.12-	Other treatment with anaerobic sludge digestion				63%	37%	-
3.4.13-	Other treatment without anaerobic sludge digestion				63%	-	37%
3.4.14-	With unspecified treatment				100%	-	-

Note:

a) Sludge accounted in other pathways include: agricultural recovery, energy recovery, landfill and composting.

Source: APA.

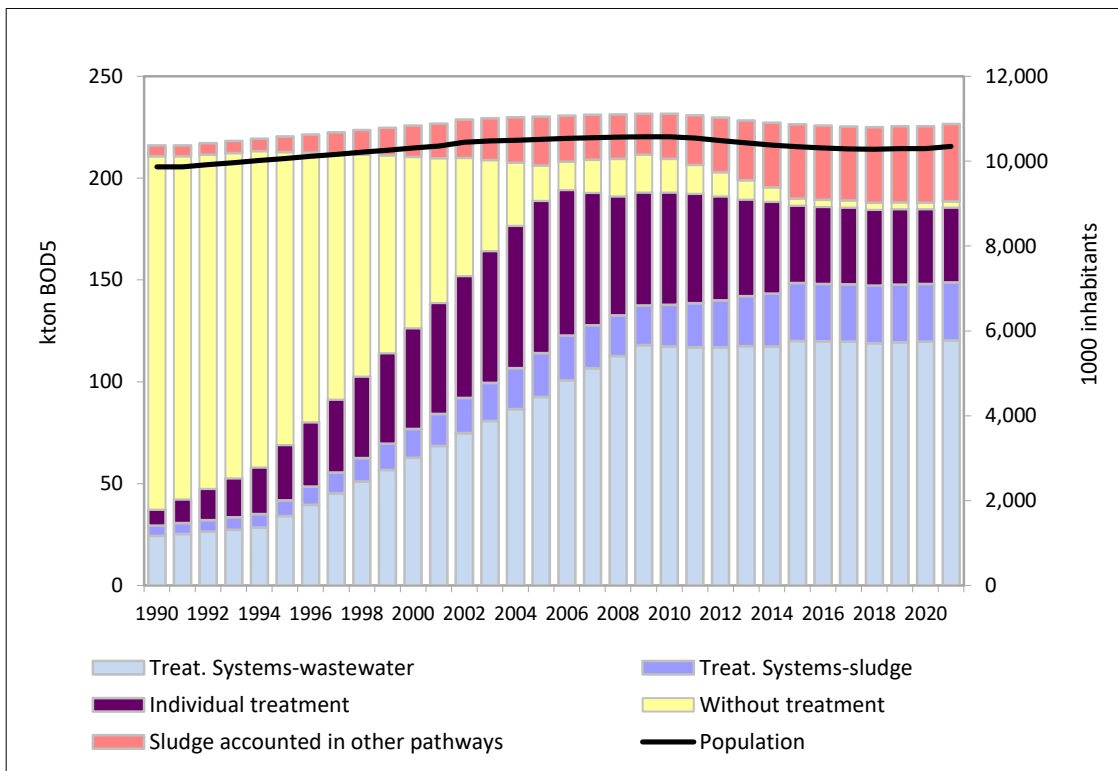

Notes:

Treatment systems – wastewater: refer to primary treatment (70% of organic load), Biodisks with and without anaerobic sludge digestion, Activated sludge with and without anaerobic sludge digestion, Lagoons without anaerobic pond, Percolation beds with anaerobic sludge digestion, Oxidation ponds and Other treatment (63% of organic load); Preliminary treatment, Treatment not specified, Lagoon, with anaerobic pond and Imhoff Tanks (100% of organic load).

Treatment systems – sludge: refer to Biodisks with anaerobic sludge digestion, Activated sludge with anaerobic sludge digestion, Percolation beds with anaerobic sludge digestion, Oxidation ponds, Other treatment (37% of organic load) and unspecified treatment.

Individual treatment: refer to wastewater not collected by a public system. It's assumed that the population has a private handling system (private septic tanks).

Without treatment: refer to wastewater collected but not treated, referring to discharges into the ocean, inland waters, soil, and unknown disposal type.

Sludge accounted in other pathways (agricultural recovery, energy recovery, landfill and composting): refer to the % of the organic load retained as non-mineralised sludge in primary treatment (30% of primary organic load generated), and 37% in activated sludge without anaerobic sludge digestion, lagoons without anaerobic pond, Percolation beds without anaerobic sludge digestion, oxidation ponds and other treatment.

Source: APA (estimates).

Figure 7-17: Wastewater and sludge BOD₅ produced according to handling systems and national population trends

The latest UNFCCC reviews recommended the consistent report of the quantity of sewage sludge spread in the environment under the waste sector and the sewage sludge applied to agricultural soils under the agriculture sector. Also, the guidance from 2006 IPCC mentions that when sludge removal data are considered, data should be consistent across the sectors and categories, and the amount disposed at SWDS, applied to agricultural land, incinerated or used elsewhere should be equal to the amount of organic component removed as sludge in CH₄ emissions estimates from domestic wastewater.

Sludge main destination solutions include agricultural recovery, energy recovery, landfill and composting and/ or co-composting with solid waste.

Emissions associated with sludge sent to landfilling, composting and incineration are accounted, respectively, in SWDS, biological treatment, waste incineration and agriculture recovery of sludge. Sludge data considered in these sectors are collected via the SIRER (Integrated System for Electronic Registry on Waste).



Regarding the agriculture recovery of sludge, information is reported to the Regional Directorates for Agriculture and Fisheries (DRAP), under Decree-Law no. 276/2009, of 2 October, which revoked the previous Decree-Law no. 118/2006 of 21 June transposing the Council Directive 86/278/EEC, of 12 June, and establishes the regime for the use of sewage sludge in agricultural soils.

Table 7-26: Wastewater handling systems and associated Methane Conversion Factors (MCF)

Wastewater handling systems			General WW Handling Systems and Plants		Centralised WWT Plants	
			Wastewater	Sludge	Wastewater	Sludge
Population without sewerage						
1.1-	% Pop: without sewerage (latrines)	a)	0.61	-	-	-
1.2-	% Pop: individual treatment (private septic tanks)		0.50	-	-	-
Population with sewerage						
2.1-	% de Pop: with discharge into the ocean, without treatment		0.00	-	-	-
2.2-	% de Pop: with discharge into inland waters, without treatment	b)	0.30	-	-	-
2.3-	% de Pop: with discharge into soil, without treatment	b)	0.30	-	-	-
2.4-	% de Pop: with unknown disposal		0.20	-	-	-
3-	% Pop: with treatment					
3.1-	% Pop: colective septic tanks		0.50	-	-	-
3.2-	% Pop: with preliminary treatment		0.00	0.00	-	-
3.3-	% Pop: with primary treatment		0.00	0.00	0.00	0.00
3.4-	% Pop: with secondary and tertiary treatment		-	-	-	-
3.4.1-	Biodisks with anaerobic sludge digestion	c)	0.17	0.80	-	-
3.4.2-	Biodisks without anaerobic sludge digestion		0.10	0.00	-	-
3.4.3-	Activated sludge with anaerobic sludge digestion	c)	0.17	0.80	0.00	0.80
3.4.4-	Activated sludge without anaerobic sludge digestion		0.10	0.00	0.00	0.00
3.4.5-	Laguning, with anaerobic pond	d)	0.20	0.00	-	-
3.4.6-	Laguning, without anaerobic pond		0.00	0.00	0.00	0.00
3.4.7-	Percolation beds with anaerobic sludge digestion	c)	0.17	0.80	0.00	0.80
3.4.8-	Percolation beds without anaerobic sludge digestion		0.10	0.00	0.00	0.00
3.4.9-	Imhoff Tank		0.80	0.00	-	-
3.4.10-	Oxidation ponds with anaerobic sludge digestion	d)	0.20	0.00	-	-
3.4.11-	Oxidation ponds without anaerobic sludge digestion		0.00	0.00	-	-
3.4.12-	Other treatment with anaerobic sludge digestion	c)	0.17	0.80	-	-
3.4.13-	Other treatment without anaerobic sludge digestion		0.00	0.00	0.00	0.00
3.4.14-	With unspecified treatment		0.20	0.00	-	-

Notes:

- a) Expert judgment, considering 85% of the cases (in majority in the North of the country) as humid conditions (MCF=0.7), and 15% in the better conditions (MCF=0.1).
- b) Expert judgment, assuming that half of the situations refer to bad conditions (stagnant sewer MCF=0.5), due to the Summer reduced flow in many sewerage, the high temperatures, and the stagnant conditions and eutrophication of inland waters in many places during that season. The other half of the situations was considered in good drainage and flow conditions of the sewer network (MCF=0.1).
- c) Wastewater: expert judgement, assuming a value between "well management" and "aerobic treatment plant, not well managed".
- d) Value corresponding to shallow lagoons (majority of systems).

Parameters: Bo - The default IPCC (2006) value for Bo 0.6 kg CH₄/kg BOD₅ was used for wastewater and sludge.

Parameters: MCF - The next table present the MCF factors used for each wastewater treatment system considered and data set used.

MCF values for “general wastewater handling systems and treatment plants” were used in the estimates for the period 1990-2009. The same values were used in the accounting of the whole period for the Autonomous Regions (islands of Madeira and Azores) and the other systems in mainland Portugal as referred above.



MCF figures for “centralised WWT plants” refer to the accounting of emissions from the AdP’s universe and other major WW treatment plants for the years after 2010. The large majority of these plants dispose of secondary treatment, and are well managed (for liquid phase MCF = 0). The plants with anaerobic sludge digestion produce biogas with energy recovery. A significant part of the plants include tertiary treatment.

Recovery of CH₄: data on biogas gas recovered refer to the amounts of biogas consumed in electrical production in municipal wastewater treatment systems. This information is collected annually by DGEG, together with data on electric energy produced and sold, typology of equipment, etc. The quantities of biogas that are reported in Nm³ were converted into CH₄ amounts, considering a density of 0.72 kg/m³ and a percentage of 60% of CH₄ in biogas. This figure is based on the assumption that municipal wastewater treatment uses anaerobic digestion and that the biogas produced has a content of 60 to 70% of CH₄ (Universidade de Coimbra, 2006).

During the waste related WG1 webinars that occurred in the autumn 2017 to discuss issues identified in the ESD-review and in the note prepared by Céline Gueguen et al. (2016), on “Wastewater treatment and discharge”, the issue related to the 2006 IPCC guidance on a combined approach for aerobic treatment of waste water with anaerobic treatment of sludge was raised. The guidelines assume MCF=0 for well managed aerobic WWTP. However, when the emissions from WWT and sludge treatment are estimated together, as proposed in the latest guidance, problems occur when the MCF = 0 is also applied to anaerobic sludge treatment, leading to zero CH₄ emissions and eventually to negative emissions if recovery is also considered.

The approach followed in the Portuguese inventory avoids however this problem, as emissions are estimated separately for water ponds and sludge treatment, considering the shares between the liquid phase and the solid treatment in percentage of organic load as presented in a previous table.

The quantities of recovered biogas considered refer only to measured biogas from anaerobic treatment of sludge. Next figure presents the quantities of biogas recovered and the respective percentages in terms of emissions generated in anaerobic sludge treatment and total emissions generated in MWWT.

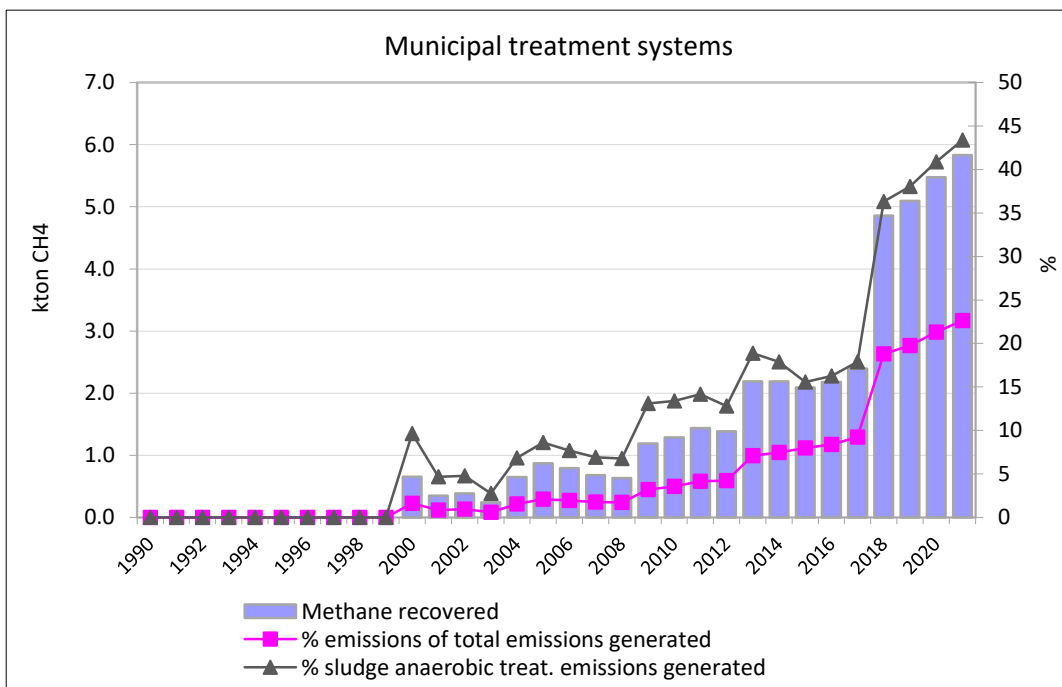

Source: Quantities based on DGEG data.

Figure 7-18: Methane recovery



7.5.2.2 Industrial Wastewater Handling CH₄ emissions

7.5.2.2.1 Methods

The method to estimate methane emissions from industrial wastewater handling is based on the methodology described in the IPCC (2006). The following formula is used:

Equation 7-8: CH₄ emissions from industrial wastewater handling

$$Emi_{CH_4} = \sum_j \{ (TOW_{(j)} - S_j) * \sum_h [WHS_{(j,h)} * MCF_{(h)}] - Rec_{CH_4(j,h)} \}$$

Where:

Emi_{CH_4} – Total methane emissions from industrial wastewater handling, t CH₄/yr;

$TOW_{(j)}$ – Total Organic wastewater generated from industrial sector j, expressed in COD, t O₂/yr;

S_j – Organic component removed as sludge, expressed in COD/yr (value assumed as zero);

$WHS_{(j,h)}$ – Part of the total organic wastewater generated in industrial sector j that is handled by system h, fraction;

$MCF_{(h)}$ – Methane Correction Factor, fraction;

$Rec_{CH_4(j,h)}$ – Quantity of methane generated from Industrial Wastewater Handling system h and industrial sector j, that is recovered and not released directly or indirectly to atmosphere, t CH₄/yr.

7.5.2.2.2 Activity data

The organic wastewater load (TOW) was estimated using statistical data on industrial production (Ind_{PROD} , ton product/yr) multiplied by pollution coefficients (Pol_{COEF} , kg O₂/ton product).

Equation 7-9: Industrial organic wastewater load

$$TOW = \sum_j Ind_{PRODj} * Pol_{COEFj}$$

Where:

TOW – Total organic wastewater load, expressed in COD, kg O₂

Ind_{PRODj} – Industrial production in industrial sector j, ton product/yr

Pol_{COEFj} – Pollution coefficients in industrial sector j, expressed in COD, kg O₂/ton product

The pollution coefficients that were used result from a study specifically done for the estimate of the loads from the Portuguese Industry (Cartaxo et al, 1985). Although these coefficients have the drawback of being relatively old, the fact that they had been developed from field monitoring data at installations in Portugal, make them more representative of the country specific conditions.

To ascertain the validity of our pollution coefficients consultation was made to the lead author of the study (Leonor Cartaxo), with a special focus was made to the top 6 industrial sectors¹.

¹ -Cork Granulation; Aliphatic hydrocarbons; Cyclic hydrocarbons; Kraft pulping; Synthetic fertilizers; Acid sulphite pulping.



The main conclusions from the meeting were:

- The COD in the Cotton fibres processing industries is mainly generated in textile printing an ink application, and should not be applied twice to production of thread production and final textile production;
- Taking into account the scope of the COD coefficients it was necessary to revised some of the industrial activity data;
- It is important to find other data sources to validate/update some of the coefficients.

In 2007 and following the consultation with Leonor Cartaxo and after careful revision of the industrial initial data, some changes were made to the activity data of specific industrial sectors.

The following table shows the pollution coefficients that were used in organic load estimates, based on the coefficients available in Cartaxo et al (1985). The set of available coefficients determined the list of industrial sectors that were considered in the estimation of water pollution discharges. For the estimation of emissions of methane TOW equals COD load.



Table 7-27: Pollution Coefficients to estimate Industrial organic wastewater production

Portuguese classification	IPCC industrial branches	Production Unit (PU)	BOD (kg/PU)	COD (kg/PU)
Slaughter House	Meat & Poultry	ton	18.0	27.0
Slaughter House, swine	Meat & Poultry	ton	18.4	41.9
Slaughter House, Poultry	Meat & Poultry	ton	5.5	12.7
Meat Packing	Meat & Poultry	ton	20.0	30.0
Milk processing	Dairy Products	m3	0.9	0.7
Cheese	Dairy Products	m3 milk	13.3	20.1
Other dairy products	Dairy Products	m3 milk	7.1	3.6
Fruit and vegetables conservat	Vegetables, Fruits & Juices	ton	15.0	27.0
Tomato juice	Vegetables, Fruits & Juices	ton	19.0	32.0
Fruit Juices	Vegetables, Fruits & Juices	ton	45.3	77.3
Fish processing and canning	Fish Processing	ton	17.5	35.0
Olive oil production	-	ton olives	15.0	45.0
Olive oil processing	-	ton	0.9	1.2
Edible oils	Vegetable Oils	ton	12.5	18.8
Margarine	Dairy Products	ton	3.3	7.5
Grains milling and processing	Starch Production	ton	4.5	9.0
Sugar processing	Sugar Refining	ton	1.9	4.2
Yeast	-	ton	600.0	1,080.0
Ethanol	Alcohol Refining	m3	328.4	1,192.3
Spirits Distillation	Wine & Vinegar	m3	94.6	217.9
Wine Cellars	Wine & Vinegar	ton grapes	4.5	7.5
Beer	Beer & Malt	m3	4.4	9.3
Mineral water and similars	Vegetables, Fruits & Juices	ton	6.0	9.6
Wool production	Textiles (Natural)	ton	89.0	366.0
Wool processing	Textiles (Natural)	ton	87.0	347.0
Synthetic fibres processing	Textiles (Natural)	ton	155.0	268.0
Artificial fibres processing	Textiles (Natural)	ton	30.0	52.0
Cotton fibres processing	Textiles (Natural)	ton	155.0	268.0
Leather industry	-	ton	85.0	212.5
Cork processing	-	ton	1.5	6.0
Cork granulation	-	ton	83.0	146.0
Kraft pulping	Pulp & Paper (Combined)	ton	27.5	30.0
Acid sulphite pulping	Pulp & Paper (Combined)	ton	283.0	200.0
Kraft paper	Pulp & Paper (Combined)	ton	0.7	2.8
Wafer board and Strand board	-	ton	14.2	43.4
Chorine and alkalis	-	ton ClNa	0.0	39.0
Inorganic acids	-	ton	0.0	50.0
Cyclic Hydrocarbons	Organic Chemicals	ton	285.0	10.0
Aliphatic Hydrocarbons	Organic Chemicals	ton	285.0	2.0
Synthetic fertilizers	-	ton	15.0	37.5
Pesticides	Drugs & Medicines	ton	22.7	30.0
Polymers	Plastics & Resins	ton	15.0	45.0
Synthetic rubber	Plastics & Resins	ton	15.0	45.0
Artificial fibres production	Plastics & Resins	ton	150.0	450.0
Polyester fibres production	Plastics & Resins	ton	6.4	16.3
Acrylic fibres production	Plastics & Resins	ton	49.5	121.1
Paints, varnishes and lacquers	Paints	ton	0.6	9.2
Pharmaceutical products	-	employe	0.0	13.5
Soaps	Soap & Detergents	ton	6.0	12.0
Detergents	Soap & Detergents	ton	0.6	1.7
Petroleum refining	Petroleum Refineries	ton	0.6	1.5



For each industrial sector identified, several statistical information sources - although obtained from the same institution - had to be used to establish the full time series from 1990 to 2021. Nevertheless, efforts were made to guarantee that the consistency in time series was not impaired by the use of different origins of information, as will be later explained. Detailed information on industrial production for each sector cannot be delivered in this report, because of confidential restraints existing in certain sectors.

For the construction of the time series the following methodology was used:

- Identification of the industrial sectors which represented 95% of the total wastewater CH₄ emissions in the Initial Report. From a total of 51 industrial sectors 15 represent 95% of the total CH₄ emissions (time period 1990-2004);
- In-depth analysis of the activity data time series for each industrial sector that represented 95% of the total wastewater CH₄ emissions. This analysis was conducted for every good produced by the 15 main industrial sectors. Extrapolations of activity data were made when required and feasible;
- General analysis of the time series for the remaining industrial sectors. For each of the 36 remaining industrial sectors a sector by sector analysis of the total goods produced was done. Again extrapolations of activity data were made when required and feasible.

Concerning the sources of information:

- Preference was given to statistical information publicly available from the webpage of the National Statistical Institute (INE) - <http://www.ine.pt/prodserv>. The use of these data guarantees the absence of confidential issues and usually comprehends the full time-series. It was not possible to use this data for all sectors because the level of disaggregation was seldom compatible with the needs of the inventory;
- The National Statistical Institute (INE) makes periodical annual surveys on industrial production. Unfortunately the survey that was executed until 1991, the IAIT survey, uses a different methodology, than the one that was used in the IAPI survey, that is being used since 1992;
- The IAIT survey was based on an inquiry to each industrial facility, used the Economic Activity Class code rev.1 (CAE rev 1) and a set of specific codes for products and materials. The IAPI survey uses the new revision of the CAE system (CAE rev2), and products and materials use a common code system (PRODCOM) in connection with CAE code. In opposition to the IAIT survey, the IAPI collected data for each company (headquarters). These two surveys were delivered to the Institute of Environment for inventory purposes, but with the compromise that confidential data could not be published;
- Refining of crude oil and petroleum products was established from the DGEG's Energy Balance and Galp's Reports, which data is available annually from 1990 till 2021;
- Production of paper pulp was available directly from the individual industrial plants, for the all period.



Table 7-28 and Table 7-29 present the building blocks of the activity data time series from the available information. Gaps in mid years were estimated by linear interpolation. In a similar mode, linear extrapolation was used to estimate data for years 1990-1991 and 2001 till 2021, whenever they were not available. All constructed time series were checked against the occurrence of inconsistencies that could appear due to the use of different sources of information². The checking of the time series was based on graph plotting of the data, and basically the aim was to detect unexpected sudden changes in the magnitude of the time series from 1991 till 1992, when IAIT was changed to IAPI. In some situations the beginning years when IAPI was started had to be discarded, because a sudden and temporary drop from IAIT values was observable and after some years they rise again and continue with a trend compatible with that that existed in IAIT. It was assumed that an adaptation period to the new industrial survey lead to a temporary underestimation of industrial production statistics.

Table 7-28: Sources of Information used to define the time-series of industrial production (1/2)

Industry	IAIT CAE rev1	IAPI PRODCOM	Infoline	Note
Slaughter House			1990-2021	Cattle, sheep, goats and horses
Slaughter House, swine			1990-2021	
Slaughter House, Poultry			1990-2021	Broilers, Turkeys, ducks, quails, ostrich, guinea-fowl, geese, pheasants, partridge and pigeons
Meat Packing	311120	15130-1513013-151301190200	-	
Milk processing	3112		1994-2021	
Cheese	3112	15510	-	
Other dairy products	3112		1994-2021	Cream, yogurt, powder milk, ice-creams
Fruit and vegetables conservation	3114		1994-2021	
Tomato juice			1994-2021	
Fruit Juices	3131+3132		1994-2021	
Fish processing and canning	3114	15200	-	
Olive oil production		15412	-	
Olive oil processing	31152	15420113	-	
Edible oils	31152	1541; 1542	-	Only Olive oil
Margarine	31154	1543	-	
Grains milling and processing	3116	156; 15860	-	
Sugar processing	3118	15830	-	
Yeast			1993-2021	
Ethanol	313110	159101070; 1592011	-	
Spirits Distillation	3131+3132	1591010-159101070+1592012	-	
Wine Cellars	3131+3132	15930; 15950	2001-2021	
Beer	3133	1596010	-	
Mineral water and similars			1993-2021	

² It must be stressed though, that all information sources were produced by the National Statistical Institute (INE). Only methodological procedures for data collection change according to years.



Table 7-29: Sources of Information used to define the time-series of industrial production (2/2)

Industry	IAIT CAE rev1	IAPI PRODCOM	Infoline	Note
Wool production		171002021	-	
Wool processing		171002027;1710042; 1710053	-	
Synthetic fibres processing	321130	171003031; 171003039;1710052 31/32/33/39/91/92/93 /99;1710055	171003039+17 1005231/32/33/ 39/91/92/93/99 +1710055	
Artificial fibres processing	321130	171003050;1710054/ 55	-	
Cotton fibres processing	321130	1710043; 171004553; 171004555; 171004557; 1720020; 173001023	-	
Leather industry		19101; 19102	-	
Cork processing	162902250; 162902290; 162902320; 162902350; 162902380	-	-	
Cork granulation	162902320; 162902350; 162902380	-	-	
Kraft pulping			-	LPS Data
Acid sulphite pulping			-	LPS Data
Kraft paper	3412	2112022; 2112023	-	
Wafer board and Strand board	33 (code 15460)	20202	-	
Chorine and alkalis		241301111; 2413015; 2413022	-	
Inorganic acids		2413014-241301453- 241301475- 241301477	-	
Cyclic Hydrocarbons		2414312; 2414314	-	
Aliphatic Hydrocarbons		2414311	-	
Synthetic fertilizers		2415	-	Original units is kg N, kg P2O5 and K2O and were converted to ton of fertilizer
Pesticides	3512	242	-	
Polymers	351312	24160-2416058	-	
Synthetic rubber		2417	-	
Artificial fibres production		2470023; 247003070	-	
Polyester fibres production		247001130; 247001315; 247001350	-	
Acrylic fibres production		247001150	-	
Paints, varnishes and lacquers	3521	24301	-	
Pharmaceutical products			1998-2021	
Soaps		2451131	-	
detergents		2451120/32	-	
Petroleum refining			-	DGEG EBs and Galp Reports: 1990-2021

Notes:

Cork industries: codes refer to CAE rev.3 (Economic Activity Class code).

Total wastewater load aggregated per industrial group is presented in Figure below, from where it is evident the continuous growth of discharge from 1990 to 2007, and the predominant importance of wastewater loads from the industry of food and drink, wood and wood derivatives and from the chemical industry. After that period the situation decreased and in later years an increasing trend can be observed again.

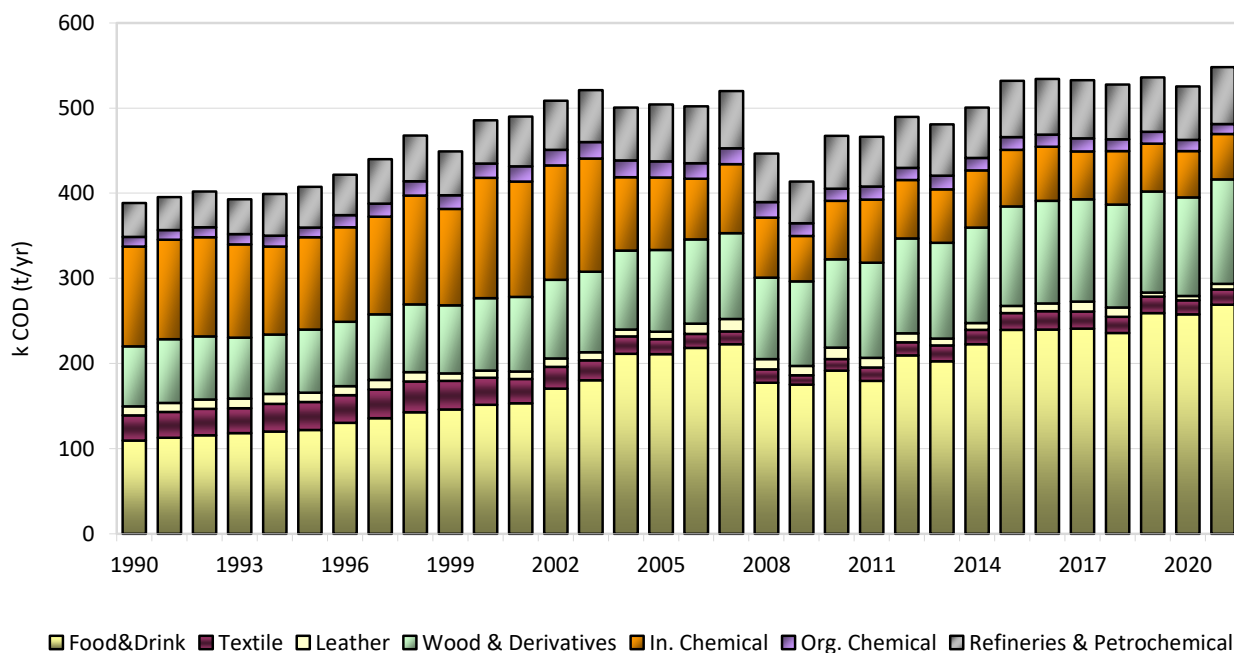
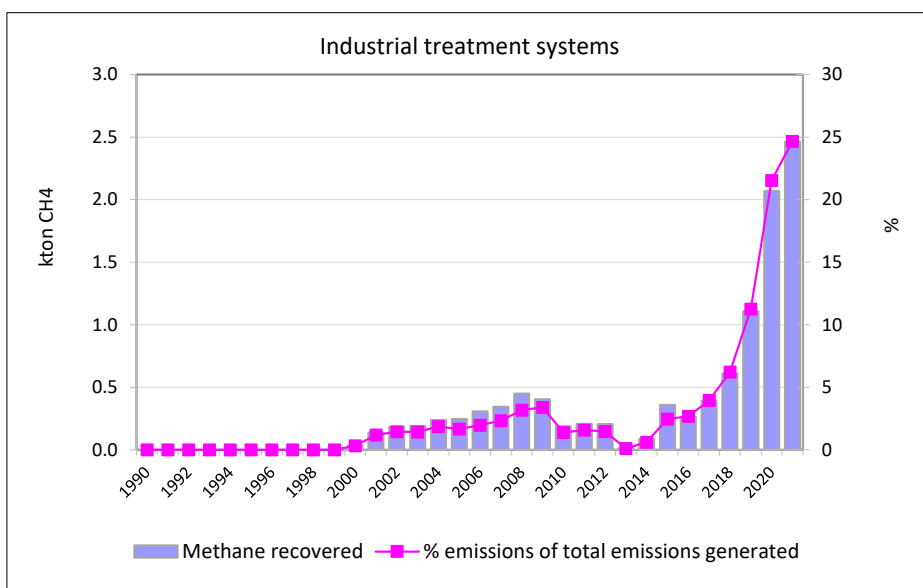

Figure 7-19: Industrial Wastewater load, expressed in COD, from major groups of industrial activity

Biogas generated in sludge treatment systems is recovered for electrical production in cogeneration units. DGEG collects information on the amounts of biogas consumed in an annual inquiry. The quantities of biogas that are reported in Nm³ were converted into CH₄, considering a density of 0.72 kg/m³ and a percentage of 60% of CH₄ in biogas. This figure is based on the assumption that wastewater treatment uses anaerobic digestion and that the biogas produced has a content of 60 to 70% of CH₄ (Universidade de Coimbra, 2006).



Source: Quantities based on DGEG data.

Figure 7-20: Methane recovery (Industry)



7.5.2.2.3 Emission factors and other parameters

7.5.2.2.3.1 Wastewater handling systems types

As consequence of the fact that there was no available comprehensive information about the existence of each treatment system, the necessary information to determine the %s for each sector had to be guessed specifically for the inventory using information collected from:

- EPER data. At the time that the inventory was compiled the EPER data was available for 2000 and partially for 2004. Information for the following sectors was available: paper pulp production; crude oil refining; slaughterhouses and meat processing; pig farms; olive oil extraction; fish canning and processing and chemical industry;
- Covenants of Environmental Adaptation. These were voluntary agreements between the Environmental Ministry, other ministries responsible for the permits of specific industrial sectors (Ministry of Economy or the Ministry of Agriculture, Rural Development and Fisheries) and several industrial associations in representation of the industrial units. The agreements were established between March 1997 and February 1998 with the objective to define a time schedule to reach the complete respect of legal constrains concerning the water, air, wastes and noise. The contract involved the elaboration of an *Assessment of the Environmental State*³ and a *Specific Plan of Elaboration*⁴. Eighteen sectors were involved: textile; dairy; stone quarrying and processing; vegetable oils; chemical industry; graphics and paper transformation; shoe making; rubber; ceramics; cork; wood and wood products; paper and card; electric and electronic equipment production; naval industry; crop protection industry; paint and varnishes, glues and adhesives and tomato processing. There was a specific agreement with the sector of extraction of olive oil;
- Information for individual plants or industrial associations, such as the paper pulp production industry and the oil refineries;
- Information collected from the Environmental Permits attributed to operators of installations covered by the IPCC Directive.

For each specific industrial sector the share of use of each specific treatment system was aggregated according to the following classes:

- There is no treatment of wastewater and the effluent is discharged in surface waters or in soil;
- Use of individual Septic Tank;
- Primary treatment only;
- Secondary treatment (aerobic), with deficient management;
- Secondary treatment (aerobic), well managed;
- Secondary treatment (anaerobic), no CH₄ recovery considered;
- Discharge into the public collecting system for treatment in urban wastewater system;

³ Caracterização da Situação Ambiental, in the original Portuguese nomenclature.

⁴ Plano Específico de Adaptação, in the original Portuguese nomenclature.



- Unknown destiny of effluent, determined as difference to total.

There was also shortage of information concerning the evolution for each sector, that is, the trend in time of the use of each specific wastewater treatment system. The following considerations apply:

- if data from the Covenants of Environmental Adaptation was used, the situation detected in the *Assessment of the Environmental State* was assumed to characterize well the situation before 1997, with no time trend. The plans were assumed to be effective in year 2000 and the situation was considered constant thereafter;
- if only one year was available, for example if data was obtained from EPER, a constant situation was assumed;
- the situation in the activity of refining of crude oil was known annually from 1990 to 2018.

Information from the Environmental Permits has been collected in latest years in order to improve the characterization of the wastewater treatment systems, in particular for the industrial sectors for which no information was available (unknown treatment).

The % of total industrial load, expressed in COD, for which the treatment system and final destination of effluents was unknown, varies from 1990 to 2021 between 49% and 10% as presented in the next table.

Table 7-30: Fraction of industrial wastewater by wastewater handling system (% of total industrial load expressed as COD)

Wastewater Handling System		1990	1995	2000	2005	2010	2015	2019	2020	2021
No treatment, discharge in river or soil	%	15.0	14.5	11.4	19.0	14.0	6.1	7.1	6.9	7.2
Primary	%	4.5	6.7	6.3	5.1	8.8	7.2	0.4	0.3	0.3
Secondary treatment: Aerobic, well managed	%	17.8	18.3	18.0	18.6	37.0	41.6	59.1	59.4	58.9
Secondary treatment: Aerobic, not well managed	%	9.6	9.6	8.0	7.3	16.9	14.8	3.5	3.3	3.4
Secondary treatment: Anaerobic, no CH4 recovery	%	0.0	0.0	0.2	2.2	2.9	2.3	2.4	2.4	2.3
Septic Tank	%	1.0	1.2	0.9	0.0	0.0	0.0	0.0	0.0	0.0
Municipal Sewer system, treatment with Municipal Waste Water	%	3.1	4.6	4.9	7.7	11.8	18.1	17.9	18.2	18.0
Unknown	%	48.9	45.0	50.3	40.0	8.6	9.9	9.7	9.5	9.8
Total	%	100.0	100.0	100.0	100.0	100.0	100.0	100.0	100.0	100.0

7.5.2.2.3.2 Methane Production Potential

The parameter B_0 , representing the maximum Methane Production Potential, was assumed constant and common to all sectors and treatment systems, and set to 0.25 kg CH₄/kg COD, the default value in the Good Practice Guidance from IPCC (2000).

7.5.2.2.3.3 Methane Correction Factor

MCF values used were established from the latest guidelines available (IPCC, 2006), and are presented in the next table.

Table 7-31: Methane Conversion Factors (MCF) and assumptions

Treatment System	MCF (%)	Explanatory Note
No treatment, discharge in river or soil	10	IPCC (2006). Table 6.8 Sea, river and lake discharge
Primary	0	Assuming that retention time is insufficient to create anaerobic conditions
Secondary treatment: Aerobic, well managed	0	IPCC (2006). Table 6.8 Aerobic Treatment Plant. Well managed
Secondary treatment: Aerobic, not well managed	30	IPCC (2006). Table 6.8 Aerobic Treatment Plant. Not well managed
Secondary treatment: Anaerobic, no CH4 recovery	80	IPCC (2006). Table 6.8 Anaerobic digester/reactor. CH4 capture not considered
Septic Tank	50	IPCC (2006). Table 6.3 Septic system
Treatment with Municipal Waste Water	9-18	Weighted average for the domestic wastewater system when there is any form of treatment.
Unknown	7-13	Weighted average based on MCF values for industrial treatment situations and respective organic load



In the case where the industrial effluent was discharged into the municipal wastewater treatment system, the MCF was determined from the average situation in Portugal for the domestic wastewater system when there is any form of treatment, either primary, secondary or tertiary. The values follow the evolution of the urban sector that was explained in previous chapters, have decreased from 18% in 1990 to 17% in 2021. For the unknown situations an average weighted MCF was calculated based on all known industrial treatment situations. Values also change over time, from 11% in 1990, 12% in 2010, and 7% in 2021.

7.5.2.2.4 Comparison of the Country Specific Methodology and the IPCC defaults

In order to evaluate if Portugal was over-estimating or under-estimating emissions in the base year, the CS Pollutant Coefficients (PC) used in submission were compared with the Pollutant Coefficients proposed by the IPCC GP (table 5.4 of the Good Practice). For the industrial sectors identified in Portugal, and whenever possible⁵, the comparison of the PC of Cartaxo el at (1985) (named CS) were compared with the equivalent IPCC in the next table⁶.

For the 2019 submission, the pollution coefficients for some sectors have been revised according to information collected from the units, literature, expert judgement and information on Best Available Techniques (BAT) reference documents, the so-called BREFs, the reference documents under the IPPC Directive (2008/1/EC) and the Industrial Emissions Directive (IED, 2010/75/EU).

The pollution coefficients that have been revised are highlighted in bold in the next table. The table notes refer the source of the new pollution coefficients considered.

⁵ The level of detail of the IPCC Pollutant Coefficients is not so detailed as the CS data set.

⁶ The original IPCC table refers only to wastewater generation rate and COD concentration. The Pollutant Coefficients presented in the table were obtained multiplying the wastewater by the COD concentration. If no recommend value was available in the original table the average value in the range was used.



Table 7-32: Comparison of Pollutant Coefficients from Cartaxo et al (1985) and IPCC defaults

Industry	Production Unit (PU)		CS (kg/PU)	IPCC default (kg/PU)	IPCC/ CS
Slaughter House	ton		27.0	53.3	1.97
Slaughter House, swine	ton		41.9	53.3	1.27
Slaughter House, Poultry	ton		12.7	53.3	4.20
Meat Packing	ton		30.0	53.3	1.78
Milk processing	m3	a)	0.7	18.9	27.00
Cheese	m3 milk		20.1	18.9	0.94
Other dairy products	m3 milk	a)	3.6	18.9	5.25
Fruit and vegetables conservation	ton		27.0	100.0	3.70
Tomato juice	ton		32.0	100.0	3.13
Fruit Juices	ton		77.3	100.0	1.29
Fish processing and canning	ton		35.0	32.5	0.93
Olive oil production	ton olives		45.0	-	-
Olive oil processing	ton		1.2	-	-
Edible oils	ton		18.8	2.6	0.14
Margarine	ton		7.5	18.9	2.52
Grains milling and processing	ton		9.0	90.0	10.00
Sugar processing	ton		4.2	35.2	8.38
Yeast	ton		1080.0	-	-
Ethanol	m3		1192.3	264.0	0.22
Spirits Distillation	m3		217.9	34.5	0.16
Wine Cellars	ton grapes		7.5	34.5	4.60
Beer	m3		9.3	18.3	1.96
Mineral water and similars	ton		9.6	100.0	10.42
Wool production	ton		366.0	154.8	0.42
Wool processing	ton		347.0	154.8	0.45
Synthetic fibres processing	ton		268.0	154.8	0.58
Artificial fibres processing	ton		52.0	154.8	2.98
Cotton fibres processing	ton		268.0	154.8	0.58
Leather industry	ton		212.5	-	-
Cork processing	ton	b)	6.0	-	-
Cork granulation	ton	c)	146.0	-	-
Kraft pulping	ton	d)	30.0	1,458.0	48.60
Acid sulphite pulping	ton	e)	200.0	1,458.0	7.29
Kraft paper	ton		2.8	1,458.0	520.71
Wafer board and Strand board	ton		43.4	-	-
Chorine and alkalis	ton ClNa		39.0	-	-
Inorganic acids	ton		50.0	-	-
Cyclic Hydrocarbons	ton	f)	10.0	201.0	20.10
Aliphatic Hydrocarbons	ton	g)	2.0	201.0	100.50
Synthetic fertilizers	ton		37.5	-	-
Pesticides	ton		30.0	-	-
Polymers	ton		45.0	2.2	0.05
Synthetic rubber	ton		45.0	2.2	0.05
Artificial fibres production	ton		450.0	2.2	0.00
Polyester fibres production	ton		16.3	2.2	0.14
Acrylic fibres production	ton		121.1	2.2	0.02
Paints, varnishes and lacquers	ton		9.2	30.3	3.29
Pharmaceutical products	employe		13.5	-	-
Soaps	ton		12.0	2.6	0.21
Detergents	ton		1.7	2.6	1.50
Petroleum refining	ton		1.5	0.6	0.40

Notes:

- a) Fresenius, W. et al, Waste Water Technology (1989).
b) Couceiro, Rúben (2015), Gestão/Tratamento de águas residuais numa indústria de produção de rolas de cortiça, ISA.
c) Average considering a production share of 30% for cork stoppers (20 kg CQO/ton) and 70% for other cork products (200 kg CQO/ton).
d) Conservative value, based on BREF BAT Ref Doc. Production of Pulp, Paper and Board, referring to Portuguese units.
e) BREF: maximum referred value.
f) Best Available Techniques (BAT) Reference Document for the Production of Large Volume Organic Chemicals; conservative value adopted, assuming the upper limit value of the non-BTX segment.
g) Conservative value based on data from a WWT plant.



7.5.2.3 N₂O emissions from wastewater

Sewage can be disposed on land or discharged into aquatic environments (e.g. rivers and estuaries), either directly without treatment or after treatment in septic systems or wastewater treatment facilities. N₂O can occur as direct emissions from treatment plants or from indirect emissions from wastewater after disposal of effluent into aquatic environments. N₂O can be generated during all these stages through nitrification/denitrification of the nitrogen in faeces, urine and other liquid wastes, which are typically in the form of urea and proteins. In general, temperature, pH, BOD₅, and nitrogen concentration influence N₂O production from human sewage.

Direct emissions from wastewater treatment plants is considered a minor source and predominantly associated with advanced centralized wastewater treatment plants with nitrification/denitrification steps. This category is considered since the revision made for this sector for the 2019 submission.

The inventory considers also, as previously, indirect N₂O emissions. Emissions from wastewater treatment that is discharged into aquatic environments are considered in this section, and those resulting from disposal of sludge in agriculture soils are included in the agriculture sector.

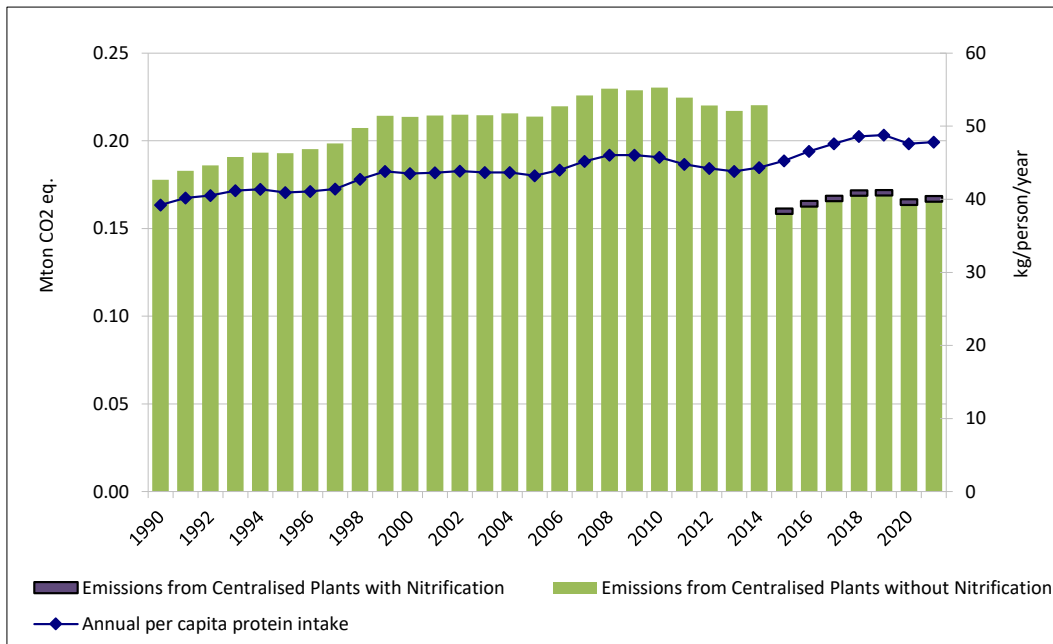

Source: Protein intake: INE data: Portuguese Food Balance Sheet (BAP).

Figure 7-21: N₂O emissions from wastewater and per capita protein intake



7.5.2.3.1 Methods

This category accounts for direct N₂O emissions from wastewater treatment plants and indirect emissions from wastewater after disposal of effluent into water bodies. Direct emissions from nitrification and denitrification at centralised wastewater treatment plants have been estimated from IPCC (2006) guidance (Box 6.1, Volume 5: Waste, page 6.26), as follows:

Equation 7-10: Direct N₂O emissions from wastewater treatment plants

$$N2O_{(PLANTS)} = P * T_{PLANT} * F_{IND-COM} * EF_{PLANT}$$

Where:

N₂O_(PLANTS) - N₂O emissions from plants (kg N₂O/yr);

P - number of inhabitants in the country;

T_{PLANT} - fraction of population served by modern centralized WWT plants (%);

F_{IND-COM} - factor for industrial and commercial co-discharged protein into the sewer system (1.25)

EF_{PLANT} – emissions factor (3.2 g N₂)/person/year)

Indirect emissions of N₂O from wastewater were estimated following the IPCC (2006) methodology, considering that the amount of protein consumed by humans determines the quantity of nitrogen contained in sewage, and including calculations that take into account N removal with sewage sludge (applied in agriculture soils), the non-consumed protein and the industrial and commercial sources discharged into the sewer system. The application of this F_{IND-COM} is only applied to collected (sewered) wastewater (excluding septic tanks and latrines).

Indirect N₂O emissions were estimated as follows:

Equation 7-11: Indirect N₂O emissions from wastewater

$$N2O_{(S)} = (P * Protein * Fra_{CNPR} * F_{NON-CON} * F_{IND-COM}^1) - N_{SEW} * EF * 44/28$$

Where:

N₂O_(S) - N₂O emissions from human sewage (kg N₂O/yr);

P - number of inhabitants in country;

Protein - annual per capita protein intake (kg/person/yr);

F_{NPR} - fraction of nitrogen in protein (kg N/kg protein);

F_{NON-CON} - factor for non-consumed protein added to the wastewater (1.2);

F_{IND-COM} - factor for industrial and commercial co-discharged protein into the sewer system (1.25);

N_{SEW} - nitrogen in sewage sludge applied to agriculture soils (please see CRF 4.D chapter);

EF - emission factor for N₂O emissions from discharged wastewater (kg N₂O-N/kg sewage-N produced);

44/28 is the molecular weight ratio of N₂O to N₂.

The amount of nitrogen associated with N₂O emissions from WWT plants was subtracted from the nitrogen accounted in the effluent.



7.5.2.3.2 Activity data

The fraction of population served by modern centralized WWT plants considered since 2015 is approximately 30%. For the years before 2015, due to data unavailability, no nitrification/ denitrification at centralised wastewater treatment plants were considered, which represents a conservative approach.

Portuguese population refer to National Statistical Office (INE) Census for the years 1981, 1991, 2001, 2011 and 2021; intermediate years have been estimated by interpolation. Data on annual per capita protein intake refer to the “*Balança Alimentar Portuguesa - BAP*” which is updated every five years. The latest data that come available in 2021 refer to the 2016-2020 period. Data for 2021 refer to the average of the 2016-2020 period. Other parameters used in the estimations are based on the 2006 IPCC defaults. The value considered for non-consumed protein discharged to wastewater pathways is 1.2. This value refer to an expert guess that takes into consideration the fact that no garbage disposals are used in Portuguese homes, representing an intermediate value between the IPCC proposed value for developed countries using garbage disposals (1.4) and developing countries (1.1).

Table 7-33: Data and parameters used calculation of N₂O emissions from wastewater

Parameter	Year	INE data (kg/person/year)
Annual per capita protein intake	1990	39.24
	1991	40.19
	1992	40.52
	1993	41.17
	1994	41.35
	1995	40.92
	1996	41.06
	1997	41.39
	1998	42.74
	1999	43.84
	2000	43.51
	2001	43.62
	2002	43.87
	2003	43.65
	2004	43.65
	2005	43.22
	2006	44.02
	2007	45.19
	2008	46.03
	2009	46.03
	2010	45.73
	2011	44.79
2012	44.24	
2013	43.84	
2014	44.35	
2015	45.26	
2016	46.57	
2017	47.60	
2018	48.62	
2019	48.80	
2020	47.60	
2021	47.84	
Fraction of nitrogen in protein	16%	2006 IPCC default
Fraction of non-consumed	20%	Expert judgement
Emission factor	0.005 kg N ₂ O-N/kg N	2006 IPCC default

Source:

INE (2021), Portuguese Food Balance Sheet (BAP) - 2016 - 2020. 2021 data: average of the 2016-2020 period.



7.5.3 Uncertainty assessment

For urban waste water treatment the activity data, expressed in organic load to wastewater systems, was estimated from population, BOD₅ per capita production, and the degree of utilisation of each type of treatment. The error associated with these variables needs to be incorporated in the determination of the final uncertainty value. Assuming the default uncertainties proposed in 2006 IPCC, 5% for human population and 30% for BOD₅ per capita, and 50% for the degree of utilisation of each type of treatment, a final 59% error was set for this activity.

Concerning the methane emission factor, the uncertainty of this parameter includes an error for the Maximum Methane Producing Capacity (Bo), for which the GPG default of 30% was used, and the error determination in the fraction of water treated anaerobically (MCF). For urban water the uncertainty in this last fraction was estimated to vary from 47% in 1990 to as 26% in 2021, considering the percentage of individual septic tanks and the lack of knowledge of in which conditions they operate.

As regards domestic wastewater handling N₂O emissions, the activity data (N load in effluent) was estimated from the population, the protein consumption per capita, the fraction of N in protein, the factor to adjust for non-consumed protein and the quantity of N in sludge subtracted to the effluent. The error associated with these variables were set from the default range values or uncertainties proposed in 2006 IPCC: 5% for human population, 10% for the protein intake, 6.3% for the fraction of N in protein, 9% for the factor to adjust for non-consumed protein, and 20% for the factor related to industrial and commercial co-discharged protein into the sewer system. The quantity of N in sludge subtracted to the effluent is considered to be very uncertain due to scarce data on sludge amounts produced and the respective content in N, and a value of 100% was considered. The equation 3.2 was applied to estimate the overall error for the activity data which is estimated as 25% in 2021. The uncertainty considered for the emission factor (kg N₂O-N/kg-N) was set from the default range values proposed in 2006 IPCC and is approx. 2500%.

In the case of industrial waste-water systems the available information is much scarcer. The uncertainty value was estimated for each industrial sector separately for the COD load and the uncertainty in the production activity data:

- the uncertainty in load was estimated for each available coefficient of pollution from the range of COD concentration values presented in the original documentation document (Cartaxo et al, 1985). Uncertainty values range from 11%, for the dairy industry, up to 100%;
- the uncertainty of production data is 20% if data was obtained from National Statistics and 50% if was interpolated.

The uncertainty considering all industrial activities, according to their production, varied between 21 and 33%, according to years.

For industrial wastewater treatment, also the uncertainty in the methane emission factor also changes with time and considers:

- the uncertainty in Bo, the maximum methane generation potential, is 30% according to the GP;
- the error of the allocation of each specific treatment system, established from the % of unknown situations, adds 20% to the error for the known cases;
- the uncertainty in MCF for each specific treatment system, set from the GP, and varying from 10% for Secondary Treatment, well managed, to 50% for the no treatment situation.



Finally the error was determined for each industry and propagated accordingly. The final uncertainty for the methane emission factor varies in time from 16% to 37%.

7.5.4 Category specific QA/QC and verification

7.5.4.1 Wastewater Handling

7.5.4.1.1 General QC 1

General QC 1 procedures were applied following the guidance from the IPCC GPG (IPCC 2000, Table 8.1) in particular:

- Checks on data units, calculation procedures, and data field relationships;
- Check for consistency in data between source categories;
- Verification of uncertainties estimates;
- Undertake completeness checks;
- Comparison of estimates to previous estimates.

7.5.4.1.2 QC2 procedures

Country-specific emission factors, in particular for industrial wastewater sector, were compared with IPCC default values. Domestic wastewater emissions were also estimated using the IPCC default method.

National emission rates and implied emissions factors (IEF) were compared with data from other countries. Significant deviations were observed for domestic and industrial wastewater emissions. These differences are however difficult to explain as it implies a deep analysis of the methodologies used by other countries.

7.5.5 Category specific recalculations

- Industrial wastewater (5.D.2)

CH4 emissions: revision of AD for some industrial sectors: 2020.

7.5.6 Category specific planned improvements

Despite the efforts done in the data revisions and pollution coefficients update for the latest submissions, further work should be done to extent the analysis to other sub-sectors.



7.6 Biogas burning without energy recovery (CRF 5.E)

7.6.1 Category description

The capture and burning of landfill gas and biogas (e.g. from sewage sludge) is used for energy purposes or flaring (without energy recovery). The resulting CO₂ from the combustion of landfill gas and biogas of biogenic origin, only needs to be reported as a memo item when there is energy recovery. CH₄ and N₂O emissions from the combustion of landfill gas and biogas captured need to be estimated and should be included in the energy sector when there is energy recovery, or in the waste sector when is flared.

For practical reasons all information related to the estimates of emissions from biogas combustion (with and without energy recovery) is presented here. However, the emissions related to energy recovery situations are accounted in sector 1A1a, and the emissions resulting from flaring are considered in category 5E.

The inventory considers landfill gas recovery values since 2000. However, in particular flaring (without energy recovery) started before. In order to account with this practice, a questionnaire was launched by APA in 2012 with the aim of collecting the total amount of landfill gas combusted either in flaring (without energy recovery) or used for energy purposes. This inquiry was focused on the more recent years (since 2005) in order not to overload the waste systems managers.

This questionnaire considered all Municipal SWDS, which totalled in 2012, 34 landfill sites in exploration (receiving waste) in Mainland, plus 3 closed landfill sites which do not receive waste anymore (but burn biogas).

Since 2015, data on biogas is collected from management systems in a specific form included in MRRU (Municipal Waste Registration Form), at APA, I.P.

At present there are 32 MSW landfills in exploration in Mainland, 26 of which use biogas for energy recover. In the two Autonomous Regions there are 6 landfills in exploration (4 in the Azores, and 2 in Madeira (1 of them for emergency situations)).

CH₄ recovered in flares and valorised for energy purposes is estimated on the basis of average biogas flows (continuous measurement) and the number of hours of burning. The concentration of CH₄ in biogas used in the estimates of the CH₄ quantities refer to monitoring plans (quarterly measurements) measuring the biogas quality (generally CH₄, CO₂, O₂, N₂, H₂S) at the entrance of the flares or the biogas energy recovery system.

7.6.2 Methodological issues

7.6.2.1 Methods

Emissions from the combustion of landfill gas and biogas with and without energy recovery have been estimated using emission factors based on the energy of the biogas consumed (combusted).



Table 7-34: Activity data, emission factors and related emissions of biogas combusted

Quantities of landfill gas and biogas combusted			2000	2001	2002	2003	2004	2005	2006	2007	2008	2009	2010
	Electrical production a)	GJ	38,031	28,056	30,216	24,647	146,555	342,822	317,318	536,868	787,149	968,432	1,261,021
	Flaring b)	GJ	-	-	-	-	-	266,085	440,544	420,404	416,178	356,085	287,131
Quantities of landfill gas and biogas combusted			2011	2012	2013	2014	2015	2016	2017	2018	2019	2020	2021
	Electrical production a)	GJ	1,668,286	2,051,425	2,335,114	2,575,738	2,984,082	2,621,564	2,741,127	2,598,224	2,525,505	2,581,348	2,716,054
	Flaring b)	GJ	60,069	58,012	55,954	53,896	30,104	71,515	15,139	22,987	37,915	56,837	2,143
Emission factors													
	CO2	kg/GJ	54.6										
	CH4	g/GJ	1										
	N2O	g/GJ	0.1										
	NOx	g/GJ	74										
	NM VOC	g/GJ	23										
	CO	g/GJ	29										
	SOx	g/GJ	0.67										
Emissions with energy recovery (CRF 1A1a)			2000	2001	2002	2003	2004	2005	2006	2007	2008	2009	2010
	CO2 c)	kton	2.1	1.5	1.6	1.3	8.0	18.7	17.3	29.3	43.0	52.9	68.9
	CH4	ton	0.038	0.028	0.030	0.025	0.147	0.343	0.295	0.582	0.826	0.880	1.146
	N2O	ton	0.004	0.003	0.003	0.002	0.015	0.034	0.030	0.058	0.083	0.088	0.115
Emissions with energy recovery (CRF 1A1a)			2011	2012	2013	2014	2015	2016	2017	2018	2019	2020	2021
	CO2 c)	kton	91.1	112.0	127.5	140.6	162.9	143.1	149.7	141.9	137.9	140.9	148.3
	CH4	ton	1.733	2.216	2.585	2.923	2.954	2.815	3.058	2.938	2.875	2.956	3.137
	N2O	ton	0.173	0.222	0.259	0.292	0.295	0.281	0.306	0.294	0.288	0.296	0.314
Emissions without energy recovery (CRF 5E)			2000	2001	2002	2003	2004	2005	2006	2007	2008	2009	2010
	CO2 d)	kton	-	-	-	-	-	-	-	-	-	-	-
	CH4	ton	-	-	-	-	-	0.266	0.441	0.420	0.416	0.356	0.287
	N2O	ton	-	-	-	-	-	0.027	0.044	0.042	0.042	0.036	0.029
Emissions without energy recovery (CRF 5E)			2011	2012	2013	2014	2015	2016	2017	2018	2019	2020	2021
	CO2 d)	kton	-	-	-	-	-	-	-	-	-	-	-
	CH4	ton	0.060	0.058	0.056	0.054	0.030	0.072	0.015	0.023	0.038	0.057	0.002
	N2O	ton	0.006	0.006	0.006	0.005	0.003	0.007	0.002	0.002	0.004	0.006	0.0002

Notes:

- a) Includes landfill biogas and other (e.g. sludge treatment plants) with energy recovery. Data refer mostly to DGEG data.
- b) Data refer to landfill gas flared without energy recovery. APA data.
- c) Memorandum item.
- d) According to the guidelines, CO2 emissions from source categories “Solid waste disposal on land and Waste incineration” should only be included if they derive from non-biological or inorganic waste sources.

7.6.3 Uncertainty Assessment

CH4 and N2O emissions from biogas flaring reported in category 5E refer to data collected from a direct enquiry to landfill management systems and refer to measured data. The uncertainty value for quantities of biogas flared was set at 5 %, which is in accordance to the values considered for LPS data in category 1A1a (biogas burning with energy recovery).

The uncertainty associated with CH4 and N2O emission factors was set to 150 % and 1000 %, respectively.

7.6.4 Category specific QA/QC and verification

General CQ1 procedures were applied.

7.6.5 Category specific recalculations

No recalculations have been made since last submission.

7.6.6 Category specific planned improvements

Not foreseen.



8 Other (CRF 6)

Portugal does not report any emissions under Other sector.



9 Indirect CO₂ and Nitrous Oxide emissions

Updated: March 2023

Indirect CO₂ emissions represented 312 kt in 2021 (considering also solvent use and road paving emissions) and 0.6% of total emissions, increasing 29% from year 1990. The two most relevant sectors are Industrial Processes (CRF 2) and Energy (CRF 1), with respectively, 54% and 46% of indirect CO₂ emissions.

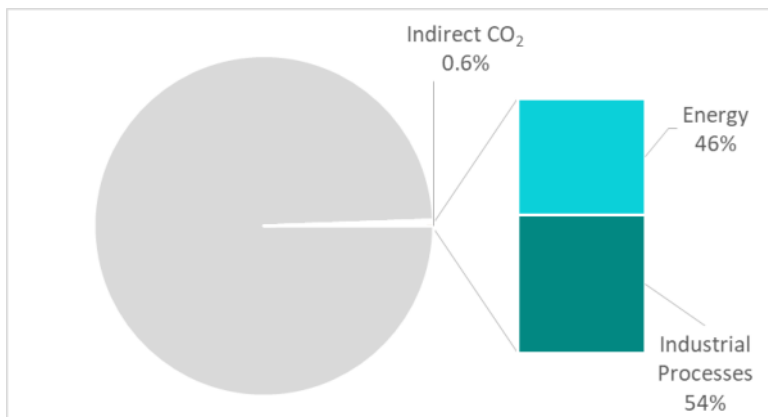

Figure 9-1: Indirect CO₂ emissions in 2021

In 2021, the most relevant category to indirect CO₂ emissions was 2D3a, representing 42% of the total (from which 99% NMVOC and 1% CO), followed by 1B2a (35% of indirect CO₂ emissions, from which 84% CO and 15% NMVOC), 1A2f (10% of indirect CO₂ emissions, from which 60% NMVOC; 32% CO; 8% CH₄) and 2B8 (8% of indirect CO₂ emissions, from which 79% NMVOC; 9% CO; 12% CH₄).

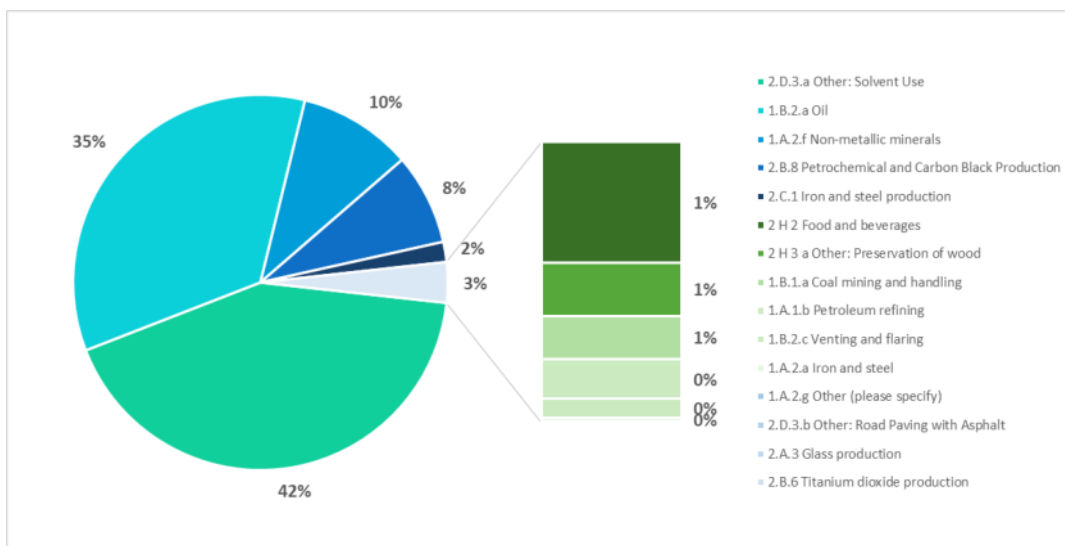

Figure 9-2: Indirect CO₂ emissions by CRF category in 2021

In order to ensure consistency with Portugal reporting under the first commitment period of the Kyoto Protocol, indirect CO₂ emissions from solvent use and road paving with asphalt are reported in category 2D3a and 2D3b of the CRF tables. For other sources of indirect CO₂, the emissions are reported in CRF Table 6.

In the calculation of indirect CO₂ emissions, only fossil carbon has been considered.



Indirect CO₂ emissions due to atmospheric oxidation of NMVOC, CH₄ and CO emissions are calculated using the equation below:

Equation 9-1: Indirect CO₂ emissions

$$Emissions_{CO_2} = \left[Emissions_{NMVOC} \times 0.60 \times \frac{44}{12} \right] + \left[Emissions_{CH_4} \times \frac{44}{16} \right] + \left[Emissions_{CO} \times \frac{44}{28} \right]$$

According to the information provided by box 7.2 of Volume 1: General Guidance and Reporting of 2006 IPCC Guidelines, the carbon fraction of NMVOC is assumed to be 60% by mass.

CH₄ estimates, methodologies and emission factors are presented in this document.

NMVOC and CO emissions are reported under the United Nations Economic Commission for Europe’s Convention on Long-Range Transboundary Air Pollution and the European Union National Emissions Ceilings Directive. Methodologies and emission factors used in the estimates are presented in the Portuguese Informative Inventory Report.

The following table indicates which CRF categories contribute to CO₂ indirect emissions and where these emissions are reported (CRF Table 6 or in the sectorial tables).

Table 9-1: CRF categories and description of CO₂ Indirect emissions

CRF category	Description	Indirect CO ₂	NMVOC	CH ₄	CO	Reported in:
1.A.1.b	Petroleum Refining	✓	✓	✓	✓	Table 6
1.A.1.c.i	Manufacture of Solid Fuels	✓	✓	✓	✓	Table 6
1.A.2.a	Iron and Steel	✓	✓	✓	✓	Table 6
1.A.2.f	Non-metallic Minerals	✓	✓	✓	✓	Table 6
1.A.2.g	Iron and Steel	✓	✓	✓	✓	Table 6
1.B.1.a.1.i	Underground Mines – Mining Activities	✓	✓	✓		Table 6
1.B.1.a.1.ii	Underground Mines – Post-Mining Activities	✓		✓		Table 6
1.B.1.a.1.iii	Abandoned Underground Mines	✓		✓		Table 6
1.B.1.b	Solid Fuel Transformation	✓	✓	✓	✓	Table 6
1.B.2.a.3	Fugitive Emissions – Oil – Transport	✓	✓	✓		Table 6
1.B.2.a.4	Fugitive Emissions – Oil – Refining/Storage	✓	✓	✓	✓	Table 6
1.B.2.a.5	Fugitive Emissions – Oil – Distribution of Oil Products	✓	✓			Table 6
1.B.2.c.2.i	Flaring - Oil	✓	✓	✓	✓	Table 6
2.B.1	Ammonia	✓			✓	Table 6
2.B.6	Titanium Dioxide	✓			✓	Table 6
2.B.8.b	Ethylene	✓	✓	✓		Table 6
2.B.8.f	Carbon Black	✓	✓		✓	Table 6
2.B.8.g.i	Low-Density Polyethylene (PEBD)	✓	✓			Table 6
2.B.8.g.ii	High-Density Polyethylene (PEAD)	✓	✓			Table 6
2.B.8.g.iii	Polypropylene	✓	✓			Table 6
2.B.8.g.iv	Polystyrene	✓	✓			Table 6
2.B.8.g.v	Formaldehyde	✓	✓		✓	Table 6
2.B.8.g.vi	Phthalic Anhydride	✓	✓		✓	Table 6
2.B.8.g.vii	Polyamide Fiber	✓	✓			CRF Table2(1).A-Hs1
2.B.8.g.viii	Polyester Fiber	✓	✓			CRF Table2(1).A-Hs1
2.B.8.g.ix	Polystyrene Fiber	✓	✓			CRF Table2(1).A-Hs1
2.B.8.g.x	Polypropylene Fiber	✓	✓			CRF Table2(1).A-Hs1
2.B.8.g.xi	Polyvinylchloride Fiber	✓	✓			CRF Table2(1).A-Hs1
2.B.8.g.xii	Acrylic Fiber	✓	✓			CRF Table2(1).A-Hs1
2.B.8.g.xiii	Acrylonitrile Fiber	✓	✓			CRF Table2(1).A-Hs1
2.B.8.g.xiv	Polyvinylchloride	✓	✓			CRF Table2(1).A-Hs1
2.B.8.g.xv	Polyurethane Foam	✓	✓			CRF Table2(1).A-Hs1
2.C.1.a	Steel	✓	✓	✓	✓	Table 6
2.C.1.b	Pig Iron	✓			✓	Table 6
2.C.1.d	Sinter	✓	✓	✓	✓	Table 6
2.D.3.a	Solvent Use	✓	✓		✓	CRF Table2(1).A-Hs2
2.D.3.b	Road Paving with Asphalt and Asphalt Blowing in Refineries	✓	✓	✓		CRF Table2(1).A-Hs2
2.H.2	Food and Beverages	✓	✓			Table 6
2.H.3.a	Chipboard Production	✓	✓			Table 6

10 Recalculations and Improvements

Table of Contents

10	Recalculations and Improvements	1
10.1	Overview of the review process	2
10.2	Overview recalculations	22
10.2.1	Recalculations Energy sector (CRF 1)	23
10.2.2	Recalculations Industrial Processes sector (CRF 2).....	23
10.2.3	Recalculations Agriculture sector (CRF 3).....	24
10.2.4	Recalculations LULUCF sector (CRF 4)	24
10.2.5	Recalculations Waste sector (CRF 5)	25

List of Tables

Table 10-1:	Reporting on implementation of UNFCCC recommendations and adjustments	3
Table 10-2:	Reporting on implementation of ESD recommendations	21
Table 10-3:	Synthesis of the recalculations made for the 2023 inventory submission by CRF category and their implications to the emissions level in 1990 and 2020.....	22



10 Recalculations and Improvements

Updated: March 2023

This section presents an overview of responses to the reviews and information on recalculations made in this submission. Recalculations made result mostly from recommendations issued from last EU and UNFCCC reviews reports and updates of activity data.

10.1 Overview of the review process

Table 10-1 presents the status of implementation of recommendations included in the UNFCCC Draft report on the individual review of the greenhouse gas inventory.

Table 10-2 presents the status of implementation of the findings included in the Final Review Report of the 2022 annual review of national greenhouse gas inventory data pursuant to Article 19(2) of Regulation (EU) No 525/2013, regarding the 'Effort Sharing Decision' (ESD).



Table 10-1: Reporting on implementation of UNFCCC recommendations and adjustments

CRF category / issue	Review recommendation	Review report / paragraph	MS response / status of implementation	Reason for non-implementation	Chapter/section in the NIR
Uncertainty analysis (2018-2022)	"Avoid reporting the uncertainty of the AD or EFs as 0.0 per cent, ensure that the uncertainty analysis incorporates and reports the intended information by checking for and correcting coding and compilation errors and document the results of this QA/QC procedure in the NIR. The ERT considers that the recommendation has not been fully addressed because the Party has not yet included in the uncertainty analysis values that characterize the uncertainties associated with AD and EFs for category 4.G (HWP)."	G.4	Implemented.		Art12_AnnexX_Uncertainty and completeness.xlsx; 15th April 2023 NIR Annex H: Uncertainty Assessment
Uncertainty analysis (2020-2022)	Report thorough work to quantify the assumptions used when defining the uncertainty of parameters for the LULUCF sector, including the key assumptions, choice of methods and detailed results, in accordance with the 2006 IPCC Guidelines (vol. 1, chap. 3, section 3.5).	G.5	To be developed in the future.	Portugal made in 2022 an extensive recalculation of the LULUCF sector. Unfortunately it was still not possible to revise and present in this submission the uncertainty estimates for LULUCF.	
Notation keys (2022)	<p>In CRF table 9 for 2020, Portugal notes three cases in which "NE" has been reported for insignificant categories, namely CO₂ and CH₄ emissions for category 2.C.2 (ferroalloys production) and N₂O emissions from category 2.G.3.b (other – propellant for pressure and aerosol products).</p> <p>In the sectoral sections of its NIR, Portugal presented the likely level of emissions, for the CO₂ emissions for category 2.C.2, based on available AD for 2011–2014 and 2017–2020 and a default tier 1 CO₂ EF and, for the N₂O emissions for category 2.G.3.b, for 1990 and 2016. During the review, Portugal provided data on the likely level of emissions for each of the three categories for 2020.</p> <p>The ERT encourages Portugal to include in every submission for categories for which "NE" has been reported data on the likely level of emissions or removals for the latest reported inventory year to show that it is below the significance threshold, in particular for categories included in the 2006 IPCC Guidelines.</p>	G.6	Implemented.		Section 4.4.3 Section 4.8.6



CRF category / issue	Review recommendation	Review report / paragraph	MS response / status of implementation	Reason for non-implementation	Chapter/section in the NIR
Inventory planning	<p>In the previous annual review report, the ERT noted that the Party reported in its NIR (p.1-24) that future inventory improvements are defined for each sector by the relevant inventory compiler and collated in a methodological development plan, which is updated and agreed every year. However, the NIR does not include the likely implementation dates of those improvement activities or the expected scope of the work involved.</p> <p>In table 10-1 of its NIR, Portugal stated that it is addressing this issue. During the review, Portugal presented several examples of improvements regarding the expected scope of the work involved. It also noted that the likely implementation dates for improvements are often difficult to establish, in particular where improvement activities depend on data or input from external entities.</p> <p>To enhance the transparency of the list of Portugal’s planned inventory improvement activities, the ERT encourages the Party to provide in its NIR more detail on the processes involved in the methodological development plan, including the likely implementation dates of the improvement activities and the expected scope of the work involved.</p>	G.7	Continuous improvement.	<p>Portugal has been trying to progressively be more transparent and specific concerning the information given in NIR sub-chapters “further improvements”. However, we acknowledge some difficulties in providing details on the planning of methodological developments, especially as regards likely implementation dates of the improvement activities, particularly when improvement activities depend on data and inputs from external entities. Furthermore, the increasing external demands often oblige, a small inventory team like the Portuguese, to redefine priorities when issues and activities not foreseen in our working plan occur. Nevertheless, we’ll try to continue the effort to be more detailed on this subject in the following NIRs, in particular as regards the processes involved in the methodological development plan.</p>	



CRF category / issue	Review recommendation	Review report / paragraph	MS response / status of implementation	Reason for non-implementation	Chapter/section in the NIR
Fuel combustion – reference approach – all fuels – CO2 (2014-2020)	Improve the consistency between the energy balance and the data available for large point sources in order to reduce the differences between the reference and sectoral approaches. The ERT considers that the recommendation has not been fully addressed because the Party has not yet investigated the reasons for the differences between the two approaches and improved consistency between the data from the energy balance and large point sources. Further findings and insight have not been summarized in the NIR. It may not be possible to reduce the difference between the reference and sectoral approaches to 2 per cent or less in all years across the full inventory time series, but, explaining in the NIR the large difference in 1997, in particular, would help resolve this issue.	E.1	Every year the inventory team tries to improve consistency between energy balance data and large point sources, but some issues remain to be resolved, and new issues arise. In the last submissions an effort was made to substantially reduce the differences, which are for several years of the time series below 2%.		3.12 Reference Approach
Feedstocks, reductants and other non-energy use of fuels – liquid fuels – CO2 (2014-2022)	Carry out QC checks for non-energy use of fuels, as prescribed in the 2006 IPCC Guidelines (vol. 3, chap. 1.4). The Party refers in its NIR to the emissions from the non-energy use of fuels in section 2.3 (p.2-9), section 3.11.5 (p.3-156) and section 4.5 (p.4-87). NIR section 4.5.2.6 on category-specific QA/QC and verification (p.4-89) presents no evidence of additional QC checks, with respect to non-energy use of fuels. During the review, the Party clarified that it did not carry out any QC checks for non-energy use of fuels in its 2022 submission.	E.2	Not implemented.	This recommendation was not considered a priority in the annual tasks to improve the reporting of the GHG inventory. And for that reason, the information requested in the NIR was not included. To be considered in next year's submission.	
Feedstocks, reductants and other non-energy use of fuels – liquid fuels – CO2 (2013-2018)	Provide information on non-energy use of LPG, naphtha and natural gas and indicate the categories under which the related emissions, if any, have been included. Portugal considers that it is not technically possible to include correct information for CO2 emissions related to the non-energy use of natural gas since there is no option to choose category 1.B.2.a.4 and intends to include this justification in its next NIR. To fully address this issue, Portugal should include a transparent and complete justification of its reporting of CO2 emissions related to the non-energy use of natural gas in its NIR.	E.3	Implemented. A justification was included in chapter 3.11.5 feedstocks of NIR 2023, with the intention of explaining the reporting of CO2 emissions related to the non-energy use of natural gas in Table 1A(d)."		3.11.5 Feedstocks CRF Tables 1A(d)
1.A.1 Energy industries – all fuels – CO2 (2015-2022)	Develop a country-specific CO2 EF for natural gas and provide further information on the reasons for not deriving country specific CO2 EFs for other fuels (hard coal and fuel oil) that are identified as key. The CO2 EF for natural gas is country-specific and is obtained from EU ETS reports. Portugal can fully resolve this issue by 1) providing transparent reasons about why it has chosen not to derive country-specific CO2 EFs for hard coal and fuel oil, clearly explaining why the current EFs used do not underestimate emissions; or, 2) develop country-specific EFs for hard coal and fuel oil.	E.5	Addressing. The national specific emission factor for Natural Gas was estimated. In the case of Fuel Oil it will not be possible to make such an estimate because there is no specific national information for this fuel. In the case of the Hard coal, practically all coal-burning facilities monitor the carbon content of burned fuel, so most emissions are estimated using TIER 3 methods using facility-specific EF.		



CRF category / issue	Review recommendation	Review report / paragraph	MS response / status of implementation	Reason for non-implementation	Chapter/section in the NIR
1.A.2 Manufacturing industries and construction – biomass – CO ₂ , CH ₄ and N ₂ O (2020 - 2022)	<p>Analyze the differences between the previous methodology and the new methodology introduced in 2011 to enhance consistency and recalculate biomass consumption for before 2011, if necessary.</p> <p>During the review, the Party clarified that revisions to the time series of biomass fuel consumption in category 1.A.2 (manufacturing industries and construction) needs to be coordinated with the energy statistics and industrial operator reporting entities. Although this coordination was included in the Party's methodological development plan for the inventory, it has not yet been implemented owing to the need to implement several other higher priority improvements and the limited resources related not only to the inventory but also to other entities.</p>	E.6	Not implemented.	Revisions to the series of biomass fuel consumption in category 1.A.2 (manufacturing industries and construction), will have to be coordinated with and at the same time with energy statistics and industrial operator reporting entities. Although foreseen in the methodological developing plan of the inventory, it was not possible to implement this recommendation until now due to the implementation of several other inventory improvements and also due to limited resources related not only to the inventory but also to other entities.	
1.A.2.f Non-metallic minerals – all fuels – CO ₂ , CH ₄ and N ₂ O (2015-2022)	<p>Include explanations for the introduction of industrial waste and the rate of biogenic and fossil fuel use in the NIR. The ERT considers that the recommendation has not been fully addressed because the Party has not yet provided sufficient detail about the reasons for the changes in fuel consumption over time. The ERT suggests that adding a brief commentary about the fuel consumptions and the likely reasons for any variability in their time-series, in each industry in the category, would help resolve this issue.</p>	E.9	Not implemented.	Brief explanations regarding the industrial waste considered were included in the NIR. However, the framework for the introduction of industrial waste in the sector is missing, as well as the rates of fossil and biogenic fuels used, information that we intend to include in next year's submission.	3.4.2.3.6 Non-Metallic Minerals
1.A.2.f Non-metallic minerals – gaseous fuels – CO ₂ , CH ₄ and N ₂ O (2022)	<p>Explain in the NIR why the glass industry was the first to adopt natural gas, and why adoption was slower for the cement industry subcategory. The Party has added figure 3-27 to its NIR (section 3.4.2.3.6, p.3-54) to show the change in the use of liquid fuels and natural gas in the ceramic, lime, glass and cement production industries for 1990–2020. During the review, the Party noted that its explanation of the cement industry's fuel transition has not been updated in the NIR and is therefore incorrect, as it includes the lime production industry. To address this issue, Portugal will update the text in its next annual submission.</p>	E.10	<p>Implemented.</p> <p>Text was updated in chapter 3.4.2.3.6</p>		Section 3.4.2.3.6



CRF category / issue	Review recommendation	Review report / paragraph	MS response / status of implementation	Reason for non-implementation	Chapter/section in the NIR
1.A.3.b Road transportation – liquid fuels – CO2 (2014-2022)	Continue with the efforts to develop country-specific CO2 EFs for gasoline and diesel oil, and investigate the possibility of obtaining a country-specific CO2 EF for gasoline and diesel oil reported under the EU ETS.	E.12	Addressing	Although it has not yet been possible to develop National CO2 EFs, contacts have been initiated with national Refineries with the aim of obtaining the carbon content of fuels. We are also looking into the possibility to analyze the carbon content in the fuel samples collected under the Fuel Quality Directive.	3.5.2 Road Transportation (CRF 1.A.3.b)/ 3.5.2.8 Further Improvements
1.A.3.e.ii Other (other transportation) – gaseous, liquid and solid fuels – CO2, CH4 and N2O (2014-2022)	Report the AD and emissions from ground activities at airports under the other transportation category, explain what type of consumption is included under the item “Serviços” in the energy balance and report the fuel consumption and the associated emission estimates under the appropriate category.	E.16	Addressing.	It is not possible to separate the fuel consumption related to ground activities in airports	3.5.5 Other Mobile Sources (CRF 1.A.3.e)
1.B.2.a Oil – liquid fuels – CH4 (2018-2022)	The AD in CRF table 1.B.2 for category 1.B.2.a.3 (oil – transport) are reported as Mt but should be reported as m3. The ERT concludes this issue has not been addressed. To resolve this issue, the Party must use the correct units for the EF and conduct a specific QC check during the compilation of the inventory to ensure that the units of EF associated with CH4 emissions from oil transport have been reported correctly.	E.17	Not implemented. The AD for category 1.B.2.a.3 is reported correctly in m3 in NIR's energy chapter 3.8.3.4.4. The AD in CRF table 1.B.2 for category 1.B.2.a.3 (transport – crude consumption) will be reported correctly in m3 in the next CRF submission.	Portugal assumed AD was only being reported incorrectly in the NIR chapter. The AD in CRF table 1.B.2 for category 1.B.2.a.3 (transport – crude consumption) will be reported correctly in m3 in the next CRF submission.	Section 3.8.3.4.4
1.B.2.d Other (oil, natural gas and other emissions from energy production) – CO2 (2015-2022)	Provide detailed information on the flows and operating regimes from geothermal energy production, and on how the CO2 EFs are derived.	E.22	Not implemented.	This recommendation was not considered a priority in the annual tasks to improve the reporting of the GHG inventory. And for that reason, the information requested in the NIR was not included. To consider in a future submission.	



CRF category / issue	Review recommendation	Review report / paragraph	MS response / status of implementation	Reason for non-implementation	Chapter/section in the NIR
1.A.1.c Manufacture of solid fuels and other energy industries – solid fuels – CO ₂ , CH ₄ and N ₂ O (2022)	The ERT encourages the Party to include in NIR chapter 3 information on all emission streams for its iron and steel operations, the categories under which the emissions are reported and the rationale for their allocation. The ERT suggests adding a column to NIR table 4-39 with the section or page number to act as a cross-reference to the methodological detail for each emission stream provided in the NIR.	E.24	Implemented. A column was added to NIR's Table 4-39 with the section or page number to act as a cross-reference to the methodological detail for each emission stream provided in the NIR.		Section 4.4.2.1 Table 4-37
2. General (IPPU) – general (2013-2022)	Include information in the NIR on specific QA/QC activities for industrial processes, for example for limestone and dolomite use and for glass production (reported under other mineral products), for which this information is not currently included. The ERT considers that the recommendation has not yet been fully addressed because the Party has not included information on QA/QC activities for all categories. For some categories such as category 2.B.1 (chemical industry – ammonia production) only a generic phrase stating that QA/QC procedures included a series of checks was provided.	1.2	Addressing. This issue has already been addressed for some categories (Cement, Iron and Steel, Lime in Dedicated Plants and Ethylene production sectors). QA/QC activities are presented for the first time in this submission for Ammonia Production (2.B.1).	This issue has not yet been fully concluded, as it is an on-going and time consuming process.	Section 4.2.2.6 Section 4.2.3.6 Section 4.3.2.6 Section 4.3.10.6 Section 4.4.2.6.
2. General (IPPU) – CO ₂ (2018-2022)	Include explanations of the checks performed to ensure time-series consistency for cement production, lime production from dedicated plants, other process uses of carbonates and lead production, where two data sources are used throughout the time series. These explanations can be included in the category-specific QC section.	1.3	Addressing. Portugal improved time-series consistency for cement, lime and glass and Rockwool production.	Regarding lead production, we have begun contacting sectoral associations and have not finalized collecting the data yet.	Section 4.2.2.2 Section 4.2.3.4 Section 4.2.7.4 Section 4.2.13.4



CRF category / issue	Review recommendation	Review report / paragraph	MS response / status of implementation	Reason for non-implementation	Chapter/section in the NIR
2.A.2 Lime production – CO2 (2015-2020)	<p>Investigate whether lime production in sugar mills and artisanal production of lime for sanitation purposes or for whitewash are potential activities and, in cases where such activities are present, provide estimates of CO2 emissions.</p> <p>The ERT considers that the recommendation has not yet been fully addressed because the Party has not estimated artisanal lime production using the techniques in the 2006 IPCC Guidelines (vol. 1, chap. 5, section 5.3).</p>	1.5	<p>Implemented.</p> <p>Regarding lime production in sugar mills, we obtained data on lime production from one operating facility for the period 1997-2008 (when the lime kiln operated) and made conservative CO2 estimates, which were far below (max. 0.013%) the level of significance. CO2 emissions from lime production in sugar mills are being reported for the period 1997-2008. The artisanal production of lime for sanitation purposes or for whitewash does not exist anymore. Following further research in order to assess the relevance of the potential underestimation, rough conservative CO2 estimates were made. Artisanal production of lime was obtained for 1990-2019 and a Tier 1 CO2 emission factor was applied according to 2006 IPCC Guidelines, considering high-calcium lime (Table 2.4 of chapter "2 - Mineral Industry Emissions" Volume 3). These estimates were found to be well below the threshold of significance (below 0.013%), therefore, we consider emissions from artisanal production of lime not relevant/negligible.</p>		Section 4.2.6
2.A.2 Lime production – CO2 (2018-2022)	<p>Check whether there are data transcription errors and confirm the correctness of the data with the facilities when large inter-annual changes in the IEFs are observed, in particular for 2009–2015. The ERT considers that the recommendation has not yet been fully addressed because despite the Party checked and corrected the information for one facility, the information on the IEF variability and how the IEF was validated with the four other facilities on lime production was still missing in the NIR.</p>	1.6	<p>Addressing.</p> <p>The Party will check the CO2 IEF variability and contact the other lime production facilities in order to report information in the NIR.</p>	<p>Improving time-series consistency is an on going and time consuming process and it has not been concluded yet.</p>	Section 4.2.3.3



CRF category / issue	Review recommendation	Review report / paragraph	MS response / status of implementation	Reason for non-implementation	Chapter/section in the NIR
2.A.4 Other process uses of carbonates – CO2 (2018-2022)	Work with the data provider (the EU ETS) to improve the quality of raw material data (e.g. by contacting facilities to check for reporting errors) and use raw material data for the years for which data from the ceramics industry were collected under the EU ETS as the AD for backcasting, instead of using estimated fuel consumption data collected directly from facilities. Based on CO2 emissions in category 2A4a of EU countries the CO2 emissions for ceramic production in Portugal are 75.44 kt CO2 eq. instead of 73.33 kt CO2 eq. reported by the country, which is an underestimation by 0.004 % of the national total and therefore below the significance threshold established in paragraph 37(b) of the UNFCCC Annex I inventory reporting guidelines.	I.11	Not implemented.	Concerning ceramics sector, it was only since 2012 that this activity was included in EU-ETS system. Currently, there are still a significant number of ceramics facilities that are not included in EU-ETS (circa 30%). We have contacted ceramics sectoral associations, which were not able to provide us with national production data.	
2.C.1 Iron and steel production – CO2 (2015-2022)	<p>Estimate emissions from the use of limestone and dolomite and report these estimates under category 2.C.1. The ERT considers that the recommendation has not yet been addressed because the Party has not collected sufficient AD or estimated CO2 emissions from the use of limestone and dolomite for purposes other than lime production, for example, limestone consumed as a flux.</p> <p>The ERT also noted that if half of the limestone/dolomite used for lime production were to be used as flux in steel production, the difference in emissions from limestone and dolomite used will result in a 0.01 per cent in emissions which below the significance threshold established in paragraph 37(b) of the UNFCCC Annex I inventory reporting guidelines.</p>	I.15	<p>Implemented.</p> <p>Regarding lime production in the integrated iron and steel facility, upon contact, the facility indicated that does not possess information concerning consumption of limestone/dolomite for other purposes than lime production, due to company restructuration in 2001 and consequent loss of old data. During the 2022 UNFCCC review, the ERT also referred that if half of the limestone/dolomite used for lime production were to be used as flux in steel production, it would result in a 0.01% difference in emissions from the use of limestone and dolomite, which is below the significance threshold established in paragraph 37(b) of the UNFCCC Annex I inventory reporting guidelines. Therefore, we will continue to consider that in the period 1990-2001, all limestone/dolomite were used for lime production and that there were no other uses for limestone/dolomite in the iron and steel facility. This clarification was included in the NIR.</p>		Section 4.2.4.4



CRF category / issue	Review recommendation	Review report / paragraph	MS response / status of implementation	Reason for non-implementation	Chapter/section in the NIR
<p>2.D.3 Other (non-energy products from fuels and solvent use) – CO2 (2020 - 2022)</p>	<p>Report all indirect CO2 emissions from solvent use as indirect CO2 emissions in CRF table 6 only, without reporting those emissions in CRF tables 2(l)s2 and 2(l).Ahs2. In addition, specify and explain in the NIR the activities leading to the indirect CO2 emissions reported in CRF table 6.</p> <p>The ERT considers that the recommendation has not yet been fully addressed because the Party has not included all indirect CO2 emissions in CRF table 6 only, without reporting those emissions in CRF tables 2(l)s2 and 2(l).A-Hs2.</p>	<p>I.16</p>	<p>Not implemented.</p>	<p>The report of indirect emissions was agreed several years ago, among EU countries with the aim of ensure consistency between KP commitment periods(CP). When indirect CO2 emissions are reported in table 6, they are separated from the national total and appear in the new lines for national total with and without indirect emissions. But if indirect CO2 emissions are reported in table 2.D.3, they are part of the national total in the summary tables. Countries, like Portugal, that reported indirect CO2 emissions in inventory submissions before 2015 (CP 1) in previous CRF table 3 (Sectoral report for solvents and other products use) should continue reporting these emissions. For this reason it was recommended and agreed to report these indirect CO2 emissions in CRF table 2(l) under “2D Non-energy products from fuels and solvent use” which includes a predefined drop down list in the CRF reporter under 2D3 Other for “solvent use” and for “asphalt roofing” and “road paving with asphalt”. The rationale was then to ensure the highest consistency with 2006 IPCC Guidelines and with the previous inventory submissions. We understand that this reporting may not be totally in line with the 2006 IPCC Guidelines. However, in order to comply with such Guidelines, there should be EU</p>	<p>Section 4.2.8.1 Section 4.3.1 Section 4.2.3.1 Section 4.3.7.1 Section 4.3.10.1 Section 4.3.11.1 Section 4.3.14.1 Section 4.3.15 Section 4.3.19 Section 4.4.2.1 Section 4.5.1 Section 4.5.4 Section 4.5.5.1 Section 4.9.1 Section 4.9.3 Section 4.9.4 Section 4.9.5 ANNEX J</p>



CRF category / issue	Review recommendation	Review report / paragraph	MS response / status of implementation	Reason for non-implementation	Chapter/section in the NIR
				<p>consensus and coherence of reporting among all the Member States. If Portugal were to comply with the 2006 IPCC Guidelines, it would not be complying with other Member States reporting on this matter. Nevertheless, the inventory team has made an effort to improve the transparency of the reporting of the indirect emissions by further clarifying in the appropriate sections of the 2022 March NIR submission. We have also attached in ANNEX J of the 15th March NIR submission the paper “WG1_190216_indirect emissions.docx” which includes further explanation to the approaches taken by Portugal and all other EU MS.</p>	
<p>2.E.1 Integrated circuits or semiconductors – HFCs, PFCs, SF6 and NF3 (2015-2022)</p>	<p>Include the estimates for HFCs, PFCs, SF6 and NF3 emissions from integrated circuits or semiconductors (category 2.E.1). If emissions do not occur, use the appropriate notation key (“NO”) in the CRF tables and provide an explanation in the NIR for this assessment. If the emissions from any of these categories are judged as insignificant in accordance with paragraph 37(b) of the UNFCCC Annex I inventory reporting guidelines, use the appropriate notation key (“NE”) in the CRF tables, providing a qualitative and quantitative justification in the NIR.</p> <p>The ERT considers that the recommendation has not yet been fully addressed because the Party has not included in NIR section 4.6.2 the information provided during the review and change the notation key “NE” to “NO” in the corresponding CRF tables.</p>	<p>I.17</p>	<p>Implemented.</p> <p>In order to assess the relevance of emissions resulting from this category, conservative CO2 eq estimates were made following the guidance from section 6.2.1.1, chapter 6, Volume 3 of the 2006 IPCC Guidelines. These estimates were found to be well below the threshold of significance (below 0.002%t), therefore, we report 2.E.1 as NO from 1995 to 2010 and as NE from 2011 onwards.</p>		<p>Chapter 4.6.2</p>



CRF category / issue	Review recommendation	Review report / paragraph	MS response / status of implementation	Reason for non-implementation	Chapter/section in the NIR
<p>2.E.2 Thin-film transistor flat-panel displays – PFCs, SF6 and NF3 (2015-2022)</p>	<p>Include the estimates for PFCs, SF6 and NF3 emissions from thin-film transistor flat-panel displays (category 2.E.2). If emissions do not occur, use the appropriate notation key (“NO”) in the CRF tables and provide an explanation in the NIR for this assessment. If the emissions from any of these categories are judged as insignificant in accordance with paragraph 37(b) of the UNFCCC Annex I inventory reporting guidelines, use the appropriate notation key (“NE”) in the CRF tables, providing a qualitative and quantitative justification in the NIR.</p> <p>The ERT concluded that the recommendation has not yet been addressed because the Party has not included in NIR section 4.6.3 the information provided during the review and change the notation key “NE” to “NO” in the corresponding CRF tables.</p>	<p>I.18</p>	<p>Implemented. Concerning TFT Flat Panel Display production, we have contacted our Focal Point and the Portuguese Association of Companies in the Electrical and Electronic Sector, which informed us there never was TFT flat-panel displays production in Portugal. There is only TFT imports. Therefore, we report 2.E.2 as NO for the whole time series.</p>		<p>Chapter 4.6.3</p>
<p>2.E.3 Photovoltaics 2.E.4 Heat transfer fluid – HFCs, PFCs and SF6 (2020 - 2022)</p>	<p>Complete research on the occurrence of activities under categories 2.E.3 and 2.E.4 in the country since 1990 and report AD and emissions as “NO” if an activity has not occurred, or, if corresponding activities occur in the country, either estimate and report AD or emissions, or, if considered insignificant, report them as “NE” and demonstrate that the likely level of emissions is below the significance threshold established in paragraph 37(b) of the UNFCCC Annex I inventory reporting guidelines.</p> <p>The ERT considers that the recommendation can be fully addressed if the Party includes the information provided during the review in NIR section 4.6.4 and report AD and emissions as “NO” for category 2.E.4.</p>	<p>I.19</p>	<p>Implemented. Concerning photovoltaics production, upon contacts with our Focal Point and the Portuguese Association of Renewable Energies (APREN), we learned that a solar panel production facility was in operation in the country from 2008 to 2018 but did not used fluorinated compounds in cell production (mounted in vacuum). Another photovoltaic modules facility is in operation since 1994, however, photovoltaic cells used to assemble photovoltaic modules are imported, and there is no F-gases consumption. Therefore, given that photovoltaics activities occur in the country but do not result in emissions or removals of F-gases in Portugal, we report 2.E.3 as NA. Concerning Heat Transfer Fluid, we have contacted our Focal Point and the Portuguese Association of Companies in the Electrical and Electronic Sector (ANIMEE), which informed us there never was Heat Transfer Fluid consumption in Portugal. Therefore, we report 2.E.4 as NO.</p>		<p>Section 4.6.4 Section 4.6.5</p>



CRF category / issue	Review recommendation	Review report / paragraph	MS response / status of implementation	Reason for non-implementation	Chapter/section in the NIR
2.B.1 Ammonia production – CO2 (2022)	The Party reported in its NIR (pp.4-56–4-60) that category 2.B.1 (ammonia production) was estimated using a tier 1 approach and default EFs from the 2006 IPCC Guidelines. Furthermore, in section 4.3.2.3 of its NIR, Portugal noted that according to the 2006 IPCC Guidelines, it is good practice to use the average EF for partial oxidation (which is the process used to produce ammonia in Portugal) when no information is available on the fuel type used in the process. Portugal used the total fuel requirement of 42.5 GJ/t NH3 and CO2 EF of 3.273 tonnes CO2/tonne NH3) sourced from the 2006 IPCC Guidelines (vol. 3, chap. 3.2.2.2, table 3.1). The use of this EF leads to an overestimation of emissions for this category. During the review, the Party clarified that it has contacted the ammonia production facilities and was informed that they do not possess data related to feedstock consumption for 1990–2009, as the facilities have been restructured and the records are no longer available. Category 2.B.1 is a key category and so a tier 2 or 3 method should be used to estimate emissions. The ERT considers that, even though the Party correctly applied a tier 1 approach, owing to the absence of suitable time-series-consistent AD for estimation of emissions using a higher tier method, it is not in line with the 2006 IPCC Guidelines. The ERT encourages the Party to use a higher-tier approach for estimating emissions from key category 2.B.1 (ammonia production).	I.24	Not implemented.	As good practice, Portugal acknowledges and pursues the application of Tier 2 methodologies or higher for Key Categories as much as technically possible. However, Portugal does not possess specific information from the ammonia production facilities such as fuel requirement and its carbon content and carbon oxidation factor, given the facilities informed that they did not possess such old data due to company restructuring, since they have long since terminated ammonia production. Therefore, no further improvements are planned to update to a higher tier approach.	
2.B.8 Petrochemical and carbon black production – CO2	The Party reported in its NIR section 4.3.11 (pp.4-67 – 4-68) the production process, methodology and EFs used to estimate CO2 emissions for category 2.B.8.c (ethylene dichloride and vinyl chloride monomer). The ERT noted that Portugal's CO2 IEF for vinyl chloride monomer production is high (1.77) and outside the range of all Annex I Parties (0.0113–0.29). During the review, Portugal confirmed that double counting occurred in this category because it used the total EF (0.294 t CO2/ t vinyl chloride monomer production) from NIR table 3.17, which already includes non-combustion and combustion processes, and then added the combustion emissions. The Party plans to correct this in its next annual submission. The ERT recommends that the Party revise the estimation of CO2 emissions from vinyl chloride monomer using at least a tier 1 approach and default EFs from 2006 IPCC Guidelines (vol. 3, chap.3.9.2.2, table 3.17).	I.25	Implemented. Upon investigation, the Party found there is no vinyl chloride monomer production in Portugal, therefore, VCM production is reported as NO for the whole time series.		Section 4.3.1.1
2.F.1 Refrigeration and air conditioning – HFCs and PFCs (2020)	Explain in its NIR the HFC and PFC composition of the blends used in refrigeration and air-conditioning equipment in the country. The ERT noted that some blends that the Party uses in commercial and domestic refrigeration equipment are not included in the table 7.8 of the NIR. The ERT considers that the recommendation can be fully addressed if the Party includes in its NIR the information provided during the review regarding the source of the composition and the global warming potential of the blends used.	I.21	Implemented. Information regarding the HFC/PFC composition and the global warming potential of the blends used is obtained from the Portuguese Environment Agency and was included in the 2023 NIR submission.		Section 4.7.2.4.1 Section 4.7.3.4.1 Section 4.7.3.4.2 Section 4.7.6.4.2 Section 4.7.7.4.1



CRF category / issue	Review recommendation	Review report / paragraph	MS response / status of implementation	Reason for non-implementation	Chapter/section in the NIR
3.B Manure management – CH4 (2018-2022)	Revise NIR table 5.25 and explain in the NIR that the country-specific manure management lagoon systems and tanks/earthen ponds correspond to the categories liquid/slurry with and without natural crust cover in the 2006 IPCC Guidelines, respectively. The ERT considers that the recommendation has not yet been fully addressed because the Party has not provided references to the sources that informed its description of the MMS and their alignment to the 2006 IPCC categories.	A.4	Implemented. Please check the updated description in section 5.3.3.	-	Chapter 5, section 5.3.3 - Emission Factors, table 5.23
3.D.a Direct N2O emissions from managed soils – N2O (2020-2022)	Correct the value for direct N2O emissions from managed soils for 2018 in NIR table 5-38 to match the values reported in CRF table 3.D.	A.6	Implemented.	-	Chapter 5, section 5.6 - N2O Emissions from Managed Soils (CRF 3.D), table 5-38. Values reported for direct N2O emissions from managed soils in the NIR match the values reported in CRF Table 3D.
3.A.1 Cattle – CH4 (2020)	The Party reported an estimated EF of 130.5 kg CH4/head/year for dairy cows for 2018 and stated in its NIR (p.5-17) that this value is comparable with the IPCC default value of 128 kg CH4/head/year. The ERT noted that this value is not in accordance with the 2006 IPCC Guidelines, which give 128 kg CH4/head/year as the North American default EF for dairy cattle (vol. 4, chap. 10, p.10.29, table 10.11). The ERT asked Portugal to clarify why it had selected the North American default EF. During the review, the Party clarified that milk production in Portugal (more than 8,000 kg/head/year) exceeds the value indicated for Western Europe (2,550 kg/head/year), but is closer to that of North America (8,400 kg/head/year). Therefore, the Party used for the comparison the default IPCC EF for North America (128 kg CH4/head/year) instead of the value for Western Europe (117 kg CH4/head/year) or Eastern Europe (99 kg CH4/head/year) (2006 IPCC Guidelines, vol. 4, chap. 10, table 10.11). The ERT agrees with the response provided by the Party. The ERT recommends that Portugal justify in its NIR the CH4 EF used for dairy cows (130.5 kg CH4/head/year) by comparing milk production per cow in the country with the milk production and default CH4 EF for different regions included in the 2006 IPCC Guidelines (vol. 4, chap. 10, table 10.11).	A.6	Implemented.		Chapter 5, section 5.2.3, page 5-18, footnote 11



CRF category / issue	Review recommendation	Review report / paragraph	MS response / status of implementation	Reason for non-implementation	Chapter/section in the NIR
3.D.b.2 N leaching and run-off – N ₂ O (2020-2022)	Revise the indirect N ₂ O emissions and the fraction leached from N sewage sludge applied to soils reported for 2018 for this category in the NIR and CRF table 3.D and explain this recalculation in the NIR.	A.9	Implemented. The value reported in CRF Table 3.D for 2018 is the same as the one reported in Table 5-49. This is not a recalculation that occurred from 2022 submission to 2023 submission. It was not correctly described in previous NIR, but the values have been corrected.	-	CRF Table 3.D Section 5.6.2.2 (Leaching and Runoff) Table 5-49 (EF5)
3.A Enteric fermentation – CH ₄ (2022)	The Party reported in NIR section 5.2.7 (p.5-32) that recalculations have been applied to enteric CH ₄ emissions owing to an update of national statistics on livestock numbers. However, the reasons for the update in the livestock population statistics, assumptions applied as well as sources of data used to carry out the updates are not documented in the NIR. During the review, the Party clarified that in future submissions it will improve the description of the recalculations. The increase in reported CH ₄ emissions between the 2021 and current submission has mainly been caused by the updated EFs for sheep and goats. The Party also explained that there has been a decrease in the number of non-dairy cattle from 2018 onward. The ERT recommends that the Party include information on the reasons for the update in any future updates to the livestock population statistics, assumptions applied as well as sources of data used to carry out the updates and the impact of those changes on CH ₄ emissions.	A.10	Implemented. Party has improved significantly the description of the recalculations. Please check all recalculations NIR subsectors.	-	Section 5.2.7 Section 5.3.7 Section 5.4.7 Section 5.5.4 Section 5.6.4 Section 5.7.7 Section 5.8.7 Section 5.9.7 Section 5.10.8



CRF category / issue	Review recommendation	Review report / paragraph	MS response / status of implementation	Reason for non-implementation	Chapter/section in the NIR
3.B Manure management – CH4, N2O (2022)	<p>The Party reported in NIR section 5.3.3 (p.5-36) that, since no new data on fraction of manure handled in each MMS are available, the 2010 distribution was assumed for 2019. The values for the fraction of manure handled in each MMS in 1990 and in 2020 are presented in NIR table 5-22. The ERT requested the Party to provide values and data sources for the fraction of manure handled in each MMS in 2010 and further clarify data sources of 2020 values in table 5-22. During the review, the Party clarified that the statement in the NIR should have referred to 2020 rather than 2019. Portugal’s general agriculture census for 2009 included for the first time a question for farmers related to the type of MMS in use on their farm. On the basis of that information and on the information from the national animal registration database about the number of livestock produced in pasture mode, the trend for 1990–2010 was updated in September 2017 for cattle (dairy cows, non-dairy cows and other cattle), sheep (ewes and other ovines), goats (does and other caprine) and equidae (horses, mules and asses). The Party indicated that it is in the process of analysing data from the general agriculture census for 2019 in order to update data related to MMS in use on farms in the country and plans to include the results of the analysis in its next annual submission. The Party also stated that it plans to correct the annual percentage share of each MMS for 2011–2020 and is developing a file to be updated annually by the operators with data related to MMS on farms. The ERT noted that application of the outdated shares for MMS for 2013-2019 did not lead to an underestimate for inclusion in a Saturday Paper. The ERT recommends that the Party update the fraction of manure handled in each MMS using the results of the 2019 agricultural census in the next annual submission.</p>	A.11	<p>There is work in progress in two different lines of work: 1) We are working in the update of MMS data based on 2019 Agriculture Census informations. This data will be updated in the next year submission (2014); 2) We are also developing a file to be updated annually by the operators with data related to farm specific N-flow balance, best available technologies implemented and MMS implemented in the farms. We expect to have results from this survey in 3 or 4 years. This file development will also be an extremely relevant tool in the definition of NH3 emissions reduction measures, since Portugal has exceeded the NH3 emission ceiling last year.</p>	Resource constraints.	-
4. General (LULUCF) – AD (2015-2022)	Revise the MAI and other relevant AD (e.g. the country-specific definition of important variables such as MAI and wood volume, the methodology on how the MAI is defined) and provide all methodological updates as soon as the NFI6 is officially published, in accordance with the 2006 IPCC Guidelines.	L.1	NFI6 data has now been considered.		NIR Chapter 6. Land-Use, Land-Use Change and Forestry (CRF 4)
4. General (LULUCF) – CO2, N2O and CH4 (2018-2022)	Analyse and transparently report the reasons which led to the significant inter-annual fluctuations in net emissions in the LULUCF sector, including for forest land and settlements. The Party reported in its NIR (p.10-24) that the recommendation has not yet been implemented.	L.2	Implemented.		
4. General (LULUCF) (2018-2022)	Complete CRF table summary 3s2 for all LULUCF categories and provide transparent information in the NIR on the descriptions, references and sources of information for the methodologies and EFs, as well as an indication of the level of complexity (i.e. tier) applied at the land-use subcategory and pool level. There are still categories in summary table 3s2 for which the Party has not included information on the methods and EFs used (e.g. CO2 emissions from cropland, grassland, wetlands).	L.3	Implemented.		



National Inventory Report - Portugal



CRF category / issue	Review recommendation	Review report / paragraph	MS response / status of implementation	Reason for non-implementation	Chapter/section in the NIR
4. General (LULUCF) (2018-2022)	Carry out a significance analysis to determine which carbon pools and subcategories are significant in each key category on the basis of the 2006 IPCC Guidelines (vol. 1, chap. 4.2, and vol. 4, chap. 1.3), and provide in the NIR detailed information on the results of this analysis. The Party reported in its NIR (p.10-25) that the recommendation has not yet been implemented.	L.4	Not implemented.	Portugal made in 2022 an extensive recalculation of the LULUCF sector. Unfortunately it was still not possible to implement this recommendation due to other task priorities.	
4. General (LULUCF) (2018-2022)	"(a) Revise the land-use classification scheme so that the land category other land includes only land without significant carbon stocks and land areas that do not fall within any other land-use category; (b) Reallocate shrubland to the appropriate land-use category in line with national land-use definitions (e.g. under forest land, grassland or cropland), reconstruct the land-use matrix accordingly and report the associated GHG emissions and removals from shrubland in the respective land-use category; (c) Report on the impact of this reallocation on the associated emissions and removals in the land-use categories affected, namely grassland and, if necessary, forest land and cropland. "	L.5	Implemented. "Shrublands" are now included under "Grasslands"		NIR Chapter 6. Land-Use, Land-Use Change and Forestry (CRF 4)
4. General (LULUCF) (2018-2022)	Provide detailed information on the technical specifications of the maps used for land representation, the classification protocol followed to ensure consistency over time, the QC protocol, the response design and the results of the accuracy assessment.	L.7	Implemented. New and revised land-use information has been inserted in the calculations.		NIR Chapter 6. Land-Use, Land-Use Change and Forestry (CRF 4)
Land representation (2018-2022)	Revise the assumption of constant areas for wetlands, settlements and other land between 1970 and 1994, taking into account any updated information from the new land-use map of the Portuguese Directorate-General for Territory (for 1990, 1995, 2007, 2010 and 2015).	L.8	Implemented. New and revised land-use information has been inserted in the calculations.		NIR Chapter 6. Land-Use, Land-Use Change and Forestry (CRF 4)
Land representation (2015-2022)	Correct the inconsistencies with regard to the areas of the different categories of land use and land-use change and revise the GHG emissions and removals by: (a) Ensuring that, for all years and all land-use categories, the values reported in CRF table 4.1 in the "Final area" row in year X-1 equal the values in the "Initial area" column in year X; (b) Ensuring that, for all years and all land-use categories, the values reported in CRF table 4.1 in the "Final area" row in year X for each land-use category equal the values in the background CRF tables 4.A-4.F for the total area of the respective land-use category for the same year X; (c) Ensuring that, for all years and all land remaining under the same land-use category, the cumulative area reported and taken into account in the estimation of the carbon stock changes and associated emissions and removals also appropriately takes into account the annual land-use conversions from a land-use category and the annual areas converted to that land-use category 20 or more years before;	L.11	Implemented.		CRF tables since July 2022.



National Inventory Report - Portugal



CRF category / issue	Review recommendation	Review report / paragraph	MS response / status of implementation	Reason for non-implementation	Chapter/section in the NIR
	(d) Explaining in the NIR the reasons for recalculating the associated GHG emissions and/or removals as a result of the revision of the land transition matrix.				
4.A Forest land – CO ₂ , CH ₄ and N ₂ O (2018-2022)	Include detailed information on the differences between the NFIs and the land-use map of the Portuguese Directorate-General for Territory for the forest land area, along with a justification for these differences and the reasons that led to the choice of the data source for the forest land area.	L.12	Not implemented.		
4.A Forest land – CO ₂ (2018-2022)	Establish a system for data collection on fuelwood gathering in order to collect the necessary information for estimating losses from living biomass and report on any updates on this matter in the NIR.	L.13	Implemented. A new methodology was introduced that resolves this issue.		
4.A Forest land – CO ₂ (2018-2022)	Provide detailed information on the scope and phases of the NFI6 in the NIR, including any updates with regard to the module/ phase on the evaluation of soil organic carbon.	L.14	NFI6 is concluded. The Soil Module was not implemented.	Portugal made in 2022 an extensive recalculation of the LULUCF sector. Unfortunately it was still not possible to implement this recommendation due to resource constraints.	
4.A.1 Forest land remaining forest land – CO ₂ (2018-2022)	Include in the NIR information on the justification of the expert judgment applied to estimate the MAI values reported in NIR table 6.10 and an explanation stating that these MAI values do not include loss due to mortality.	L.18	Implemented. There is now consistency between GHG Inventory and the NFI.	-	NIR Chapter 6. Land-Use, Land-Use Change and Forestry (CRF 4)
4.A.2 Land converted to forest land –	Develop further the sampling and estimation system and the application of the sampling system when developing carbon stock change estimates for mineral soils.	L.20	Not implemented.	Portugal made in 2022 an extensive recalculation of the LULUCF sector. Unfortunately it was still not possible to	



National Inventory Report - Portugal



CRF category / issue	Review recommendation	Review report / paragraph	MS response / status of implementation	Reason for non-implementation	Chapter/section in the NIR
CO2 (2014-2022)				implement this recommendation due to resource constraints.	
4.B.1 Cropland remaining cropland – CO2 (2018-2022)	Estimate and report all carbon stock changes in living biomass for perennial cropland types remaining under the same type in accordance with the 2006 IPCC Guidelines (vol. 4, chap. 5.2.1), taking into account the biomass growth and biomass losses associated with harvest, gathering or disturbance.	L.21	Implemented.		NIR Chapter 6. Land-Use, Land-Use Change and Forestry (CRF 4)
4.B.1 Cropland remaining cropland – CO2 (2018-2022)	Do not consider below-ground biomass in annual crops, in line with the IPCC default assumption (2006 IPCC Guidelines, vol. 4, chap. 5, p.5.10).	L.22	Annual Gains and Losses of biomass (above and below ground) are considered in all annual crops.		NIR Chapter 6. Land-Use, Land-Use Change and Forestry (CRF 4)
5.A Solid waste disposal on land – CH4 (2018-2022)	Make efforts to obtain information on the industrial waste growth rate from other experts in line with the 2006 IPCC Guidelines (vol. 1, annex 2A.1, p.2.20) and transparently report the expert judgment in the NIR, demonstrating compliance with the 2006 IPCC Guidelines. The Party reported in CRF table 5A and its NIR a recalculated time series for CH4 from category 5.A. During the review, the Party explained that it was not possible to identify additional expertise to support previous assumptions used to estimate the industrial waste time series for 1960–1998, hence, a new approach was developed using the value of country GDP as surrogate data for industrial waste generation and a recalculation was submitted. The ERT noted that the recalculation is not in accordance with the 2006 IPCC Guidelines (vol.1, chap.5.3.3.6, table 5.1), which highlight that the use of surrogate data as a technique for resolving data gaps is not appropriate unless there is strong correlation between data sets also state that using surrogate data as a splicing technique should not cover long periods. The ERT considers that the application of GDP as surrogate data for the determination of AD on industrial waste generation for 1960–1998 is not appropriate and the recommendation has not yet been addressed and there was a potential underestimation of emissions from disposal of industrial waste for 2013-2020. In response to the potential problem, Portugal reverted to using its previous methodology to estimate its historical time series (1960–1998) on industrial waste quantities deposited to SWDS and submitted revised estimates on Oct 24, 2022. The Party indicated that intends to reassess the time-series consistency by seeking additional expert input to establish a more robust time-series estimation in future submissions. This resolution is in line with the recommendation of the ERT and is acceptable to the ERT. The impact of the recalculation is an increase to 2020 emissions (+ 68 kt CO2 eq) for category 5A. Minor recalculations have also been submitted by Portugal under category 5C (incineration and open burning of waste) owing to the knock-on effect of the AD changes to the proportion of industrial waste that is incinerated;	W.1	In the absence of historical data on solid waste disposal an approach based on the evolution of Portuguese GDP was used in the March/April 2022 submission. The ERT considered however that the industrial waste generation was not significantly correlated with GDP proxy data used and requested Portugal to reassess the issue in a future submission.	Not yet possible to provide a new estimate of the historical industrial data series. Portugal intends to identify additional expertise to support the assumptions used to estimate the industrial waste time series for 1960–1998, and to reassess the time-series consistency.	5.A Solid waste disposal on land – CH4 (2018-2022)



National Inventory Report - Portugal



CRF category / issue	Review recommendation	Review report / paragraph	MS response / status of implementation	Reason for non-implementation	Chapter/section in the NIR
	however this only affects the emission time series for 1990–1998 under category 5C.				

Table 10-2: Reporting on implementation of ESD recommendations

CRF category / issue	Review recommendation	Review report / paragraph	MS response / status of implementation	Chapter/section in the NIR
2F1 Refrigeration and Air Conditioning, 1990-2020, HFCs	For category 2F1b Refrigeration and Air Conditioning: Domestic Refrigeration, HFC emissions in 2020, the TERT noted that Portugal reported high emissions in comparison to other Member States, as well as from refrigerants that were quite unusual for this particular subsector. In response to a question raised during the review, Portugal explained that this was due to not having yet considered the provisions of the EU F-Gas regulation 517/2014. Portugal provided a revised estimate for years 2020 and the whole time series since 1990, to be included in the next submission following further additional investigations. The TERT agreed with the revised estimate provided by Portugal and attached to the annex of the review report. The TERT recommends that Portugal include the revised estimate in its next submission.	PT-2F1-2022-0001	Implemented.	Chapter 4.7.6



10.2 Overview recalculations

The table below presents in a tabular form a synthesis of the main recalculations made in this 2023 submission and the implications in 1990 and 2020 emission levels.

Table 10-3: Synthesis of the recalculations made for the 2023 inventory submission by CRF category and their implications to the emissions level in 1990 and 2020

CRF Category	Implication To the CRF category (Gg CO ₂ eq.)		Implication to the Total Emissions without LULUCF & Indirect CO ₂ emissions (%)	
	in 1990	in 2020	in 1990	in 2020
Total	-46.19	-33.66	-0.08	-0.06
1. Energy	0.22	14.80	0.00	0.03
A. Fuel combustion activities	0.22	14.80	0.00	0.03
1. Energy industries	0.00	0.00	0.00	0.00
2. Manufacturing industries and construction	0.22	-0.21	0.00	0.00
3. Transport	0.00	15.01	0.00	0.03
4. Other sectors	0.00	0.00	0.00	0.00
5. Other	0.00	0.00	0.00	0.00
B. Fugitive Emissions from Fuels	0.00	0.00	0.00	0.00
1. Solid fuels	0.00	0.00	0.00	0.00
2. Oil and natural gas	0.00	0.00	0.00	0.00
C. CO ₂ transport and storage	0.00	0.00	0.00	0.00
2. Industrial Processes and Product Use	-46.68	-185.19	-0.08	-0.32
A. Mineral industry	-14.20	-59.51	-0.02	-0.10
B. Chemical industry	-26.63	-37.77	-0.04	-0.07
C. Metal industry	0.00	-1.49	0.00	0.00
D. Non-energy products from fuels and solvent use	-5.84	-17.24	-0.01	-0.03
F. F-gases	0.00	-69.21	0.00	-0.12
G. Other product manufacture and use	0.00	0.03	0.00	0.00
H. Other	0.00	0.00	0.00	0.00
3. Agriculture	-57.22	20.90	-0.10	0.04
A. Enteric fermentation	-0.01	51.79	0.00	0.09
B. Manure management	0.30	5.97	0.00	0.01
C. Rice cultivation	0.00	5.78	0.00	0.01
D. Agricultural soils	0.00	5.77	0.00	0.01
E. Prescribed burning of savannahs	0.00	0.00	0.00	0.00
F. Field burning of agricultural residues	-57.48	-45.64	-0.10	-0.08
G. Liming	-0.02	-0.05	0.00	0.00
H. Urea application	0.00	-2.06	0.00	0.00
I. Other carbon-containing fertilizer	0.00	-0.67	0.00	0.00
J. Other	0.00	0.00	0.00	0.00
4. Land Use, Land-use Change and Forestry	0.00	0.00	n.a	n.a
A. Forest land	0.00	0.00	n.a	n.a
B. Cropland	0.00	0.00	n.a	n.a
C. Grassland	0.00	0.00	n.a	n.a
D. Wetlands	0.00	0.00	n.a	n.a
E. Settlements	0.00	0.00	n.a	n.a
F. Other land	0.00	0.00	n.a	n.a
G. Harvested wood products	0.00	0.00	n.a	n.a
H. Other	0.00	0.00	n.a	n.a
5. Waste	57.48	115.83	0.10	0.20
A. Solid waste disposal	0.00	15.84	0.00	0.03
B. Biological treatment of solid waste	0.00	60.44	0.00	0.10
C. Incineration and open burning of waste	57.48	46.28	0.10	0.08
D. Waste water treatment and discharge	0.00	-6.74	0.00	-0.01
E. Other	0.00	0.00	0.00	0.00



10.2.1 Recalculations Energy sector (CRF 1)

Manufacturing Industries (CRF 1.A.2)

The major changes between submissions result from the following actions:

- Glass Industry (1A2f): Update of gaseous fuel consumption data for the year 2019.

Road transportation (CRF 1.A.3.b)

The major changes between submissions result from the update of activity data, namely:

- Revision of the stock and distances travelled data from 1994 to 2020;
- Revision of the incorporation rates of biofuels in 2017, 2019 and 2020;
- Revision of the share of FAME in Biodiesel and ETBE in Bioethanol in 2020;
- Revision of the 2014, 2015, 2016, 2019 and 2020 Energy Balances data provided by DGEG.

10.2.2 Recalculations Industrial Processes sector (CRF 2)

The major changes between submissions result from the following actions:

- 2.A.3 (Glass Production): correction of allocation errors regarding carbonates consumption time series were for the period 1990-2018;
- 2.A.4.a (Other Uses of Carbonates in Ceramics): correction of allocation errors regarding carbonates consumption time series for the whole time series;
- 2.A.4.b (Other Uses of Soda Ash): Consumption activity data was revised for the whole time series; imports data were revised from 2010 onwards; exports data were updated from 2013 onwards;
- 2.B.8.c (Ethylene Dichloride and Vinyl Chloride Monomer (VCM)): activity not occurring in the country, for the whole time series;
- 2.B.8.g (Other Petrochemical Production): Activity data update for minor sub-categories (please consult IIR 2023);
- 2.C.5 (Lead Production): Activity data update in 2020;
- 2.D.1 (Lubricants use): Two-stroke engines lubricants consumption data were updated for 1994-2020;
- 2.D.3.a (Domestic Solvent Use): Activity data update for minor sub-categories (please consult IIR 2023);
- 2.D.3.c (Urea based catalytic converters): Activity data were updated for 2007-2020;
- 2.E (Electronics Industry): Notation keys updated for all sub-sectors for the whole time series;
- 2.F.1.b (Domestic Refrigeration): Activity data was updated for the whole time series;
- 2.F.1.e (Mobile Air Conditioning): Data on vehicle fleet stock was updated for 1994-2020;
- 2.G.1 (Electrical Equipment): Activity data update for year 2020;
- Several minor sub-categories: Update on Gross Domestic Product (GDP) and Gross Value Added (GVA) for 2020.



10.2.3 Recalculations Agriculture sector (CRF 3)

Changes from previous submission (2021) and this year submission (2022) are due to the:

- Revision in the livestock numbers from 2017 onwards;
- Revision in the livestock numbers per climatic region from 2010 onwards;
- Update in the database used for the determination of emission factors from enteric fermentation of sheep and goats from 1998 onwards, following the same methodology used for updating non-dairy cattle information;
- New distribution between "cool" and "temperate" climatic regions, based on 2019 Agriculture Census data (from 2010 onwards);
- Update of Daily Volatile solids excreted (VS), following the methodological development plan;
- Update in "Other NP & NPK" fertilizers consumption National Statistics time series for the period 2003-2008;
- Update in "Other N" fertilizers consumption National Statistics time series for the period 2011-2013, years 2016 and 2019;
- Update in Ammonium Nitrate National Statistics in 2019;
- Update in Ammonium Sulphate National Statistics in 2018-2019 period;
- Update in Biomass Burnt from 2016 onwards;
- Revision of liming subsector activity data (lime production, imports and exports);
- Update in Urea consumption National Statistics time series for the period 2018-2019;
- Update in Calcium Ammonium Nitrate (CAN) fertilizers methodology; Since there is no reliable data for the period 2008-2014, we start using the average of the period 2015-2019; For the other periods we used National Statistics;
- Update in N content of sludge applied to soils from 2018 onwards;
- Other minor corrections were done as a result of internal QA/QC procedures which had no significant impact.

10.2.4 Recalculations LULUCF sector (CRF 4)

No recalculations were made in 2023 submission. However, after the submission of the NIR in April 2022, Portugal made a re-submission of the CRF tables and NIR in July 2022, where significant changes were included in the LULUCF chapter.

For this reason, Portugal includes below the main methodological changes and variables updates that occurred in the 2022 submission:

- Revision of land-use and land-use change data, reflecting the release of new COS and the revisions of previous COS (mainland Portugal) and the update of CLC maps information for the Autonomous Regions of Azores and Madeira
- Change in methodology to estimate harvest and allow a reconciliation of total carbon stocks derived from the National Forest Inventory and those from the GHG Inventory
- Introduction of new emission and sequestration factors for Permanent Crops, from Project LIFE MediNet
- Integration of Shrublands in "Grasslands" and not "Other Land", following a recommendation from previous UNFCCC reviews



- Harmonization of the methodology to estimate burnt areas per land-use type with land use and land-use change information, which are now estimated by overlapping the COS maps with the Annual Burnt Area maps provided by ICNF
- Inclusion of CO₂ emissions (and subsequent removals) from burnt areas of shrublands and permanent crops
- Update of harvest and HWP input data 2012-2020, reflecting the latest version of the UNECE/FAO Timber Products database.

10.2.5 Recalculations Waste sector (CRF 5)

Changes in this submission refer to:

- Solid Waste Deposited on Land (5.A.1)
CH₄ emissions: revision of activity data on MSW deposited on land: 2016-2020; revision of activity data on industrial waste deposited on land: 2020.
- Biological treatment of Solid Waste (5.B)
Composting (5.B.1)/ CH₄ and N₂O emissions: revision of activity data for the years 2013-2020. This included the accounting of non-municipal organic and garden and park waste quantities not previously considered.
Anaerobic Digestion (5.B.2) / CH₄ emissions: revision of activity data for the years 2016-2020.
- Waste Incineration (5.C.1)
Industrial and Clinical waste: activity data update for 2019 and 2020.
- Open Burning of Waste (5.C.2)
CH₄ and N₂O emissions for the whole time series: following the 2022 NECD review, Portugal reallocated emissions from residues burning of vineyard, olive trees or orchard, previously reported in the agriculture sector, to category 5C2. The emissions from in place field burning (e.g. stubble burning) remained in category 3F.
- Industrial Wastewater Handling(5.D.2)
CH₄ emissions: revision of AD for some industrial sectors: 2020.



LIST OF ACRONYMS

Acronym	English	Portuguese
ABS	Acrylonitrile Butadiene Styrene	Acrilo Nitrilo Butadieno Estireno
AC	Air Conditioning	Ar condicionado
ACAP	Portuguese Association of Automobile Business	Associação do Comércio Automóvel de Portugal
ADP	ADP fertilizers (national fertilizer industry)	ADP fertilizantes
AG	Aviation Gasoline	Gasolina de Aviação
AN	Ammonium Nitrate	Nitrato de Amónio
ANA	Airports and Air Navigation	Aeroportos e Navegação Aérea
ANAC	Portuguese Civil Aviation Authority	Autoridade Nacional da Aviação Civil
ANAM	Madeira Island Airports and Air Navigation	Aeroportos e Navegação Aérea da Madeira
ANECRA	National Association of Companies of Automobile Business and Reparation	Associação Nacional das Empresas do Comércio e da Reparação Automóvel
APED	Portuguese Association of Distribution Companies	Associação Portuguesa de Empresas de Distribuição
APIRAC	National Association of Industry of Refrigeration and Air Conditioning	Associação Portuguesa dos Industriais da Refrigeração e Ar Condicionado
APORBET	Portuguese Association of Bituminous Mixes Producers	Associação Portuguesa de Fabricantes de Misturas Betuminosas
AS	Ammonium Sulphate	Sulfato de Amónia
ASN	Ammonium Sulphate Nitrate	Sulfonitrato de Amónia
BAT	Best Available Technologies	-
BOD	Biochemical Oxygen Demand	Carência Bioquímica de Oxigénio
BOF	Basic Oxygen Furnace	-
CAFE	Clean Air For Europe	-
CAN	Calcium Ammonium Nitrate	Nitrato de Cálcio-amónio
CCDR-LVT	Lisbon and Tagus Valley Coordination and Regional Development Commission	Comissão de Coordenação e Desenvolvimento Regional de Lisboa e Vale do Tejo
CELPA	Portuguese Paper Industry Association	Associação da Indústria Papeleira
CFC	Chlorofluorocarbons	Clorofluorcarbonetos
CH4	Methane	Metano
CITEPA	Interprofessional Technical Centre of Studies of Atmospheric Pollution	Centre Interprofessionnel Technique d'Études de la Pollution Atmosphérique
CKD	Cement Kiln Dust	-
CMN	Calcium Magnesium Nitrate	-
CN	Calcium Nitrate	Nitrato de Cálcio
CO	Carbon Monoxide	Monóxido de Carbono
CO2	Carbon Dioxide	Dióxido de Carbono ou anidrido carbónico
CO2e	Carbon dioxide equivalent	Dióxido de carbono equivalente
COD	Chemical Oxygen Demand	Carência Química de Oxigénio
CONCAWE	European Oil Company Organisation for Environment, Health and Safety	Organização para o Meio Ambiente, Saúde e Segurança das Empresas Europeias de Petróleo
Concelho	Portuguese territorial unit under the responsibility of a municipal authority	-



Acronym	English	Portuguese
CORINAIR	Core Inventory Air Emissions	Inventário de Emissões Atmosféricas
CRF	Common Reporting Format	-
CTCV	Technological Centre for Ceramics and Glass	Centro Tecnológico da Cerâmica e do Vidro
DAP	Di-ammonium phosphate	-
DBH	Diameter at Breast Height	Diâmetro à Altura do Peito (DAP)
DC	Degradable Organic Component	Fracção Orgânica Degradável
DGA	General Directorate of Environment	Direcção Geral do Ambiente
DGADR	General Directorate for Agriculture and Rural Development	Direção Geral de Agricultura e do Desenvolvimento Rural
DGAE (ex DGE)	General Directorate for Economic Activities	Direcção Geral das Actividades Económicas
DGAV	General Directorate for Food and Veterinary	Direção geral de Alimentação e Veterinária
DGEG (ex DGEG)	General Directorate for Energy and Geology	Direcção Geral de Energia e Geologia
DGF	General Directorate of Forests	Direcção-Geral das Florestas
DGRF	General Directorate for Forestry Resources	Direcção Geral dos Recursos Florestais
DGTT	General Directorate of Terrestrial Transportation	Direcção Geral dos Transportes Terrestres
Distrito	Portuguese territorial unit comprehending several counties but not coincident with a region which is NUT II.	-
DOC	Degradable Organic Carbon	Carbono Orgânico Degradável
DOCF	Degradable Organic Carbon Dissimilated	-
DRAOT	Regional Directorate of Environment and Land Use Planning	Direcção Regional do Ambiente e Ordenamento do Território
EAF	Electric Arc Furnace	Forno Arco Eléctrico
EAPA	European Asphalt Pavement Association	-
EF	Emission Factors	Factores de Emissão
EMEP	Cooperative Programme for Monitoring and Evaluation of the Long-range Transmission of Air Pollutants in Europe	-
EPER	European Pollutant Emission Register	Registo Europeu de Emissões Poluentes
E-PRTR	European Pollutant Release and Transfer Register	-
FAEED	Federal Aviation Administration Aircraft Engine Emission Database	-
FAM	Animal Manure Nitrogen Applied to Soils	-
FAO	Food and Agriculture Organization of the United Nations	-
FCC	Fluidized-bed Catalytic Cracking	Cracking catalítico de leito fluidizado
FCR	Fixation in Crop Residues	-
FCT-UNL	Faculty of Science and Technology of New University of Lisbon	Faculdade de Ciências e Tecnologia da Universidade Nova de Lisboa
FGR	Annual amount of nitrogen in animal excreta (faeces and urine) deposited directly in soil during grazing in pasture and adjusted to account for the amount that volatilises as NH3	-
FOD	First Order Decay	Decaimento de Primeira Ordem
FSN	Nitrogen in Synthetic Fertilizers	-



Acronym	English	Portuguese
GASA	Analysis Group of Ambient Systems	Grupo de Análises de Sistemas Ambientais
GCV	Gross Calorific Value	-
GHG	Green House Gases	Gases Com Efeito de Estufa
GHV	Gross Heating Value	Poder Calorífico Superior
GIC	Large Combustion Plants (LCP)	Grandes Instalações de Combustão
GPG	Good Practice Guidance	-
GPP	Planning and Policies Office	Gabinete de Planeamento e Políticas
GPPAA	Agriculture and Food Planning and Policies Office (changed to GPP)	Gabinete de Planeamento e Política Agro-Alimentar
GWP	Global Warming Potential	-
H2S	Hydrogen Sulphide	Sulfureto de Hidrogénio
HCFC	Hydrochlorofluorocarbons	-
HDPE	High Density Poly Ethylene	-
HDV	Heavy Duty Vehicles	Veículos Pesados de Mercadorias
HFC	Hydrofluorocarbons	-
APA	Portuguese Environmental Agency	Agência Portuguesa do Ambiente
IAIT	Annual Survey to Manufacturing Industry	Inquérito Anual à Indústria Transformadora
IAPI	Annual Survey to Industrial Production	Inquérito Anual à Produção Industrial
ICAO	International Civil Aviation Organization	
IEF	Implied Emission Factors	Fatores de Emissão Implícitos
IEP	Portuguese Road Institute	Instituto de Estradas de Portugal
IFA	International Fertilizer Industry Association	
IFADAP	Institute for Financing and Support of Development of Agriculture and Fisheries	Instituto de Financiamento e Apoio ao Desenvolvimento da Agricultura e das Pescas
IFRAA	Forestry Inventory of the Autonomous Region of Azores	Inventário Florestal da Região Autónoma dos Açores
IFRAM	Forestry Inventory of the Autonomous Region of Madeira	Inventário Florestal da Região Autónoma da Madeira
IMT (ex. IMTT, DGV)	Institute for Mobility and Transportation	Instituto da Mobilidade e dos Transportes
INAG	National Water Institute	Instituto da Água
INE	National Statistics Institute	Instituto Nacional de Estatística
INIAV	National Institute for Agriculture and Veterinary Research	Instituto Nacional de Investigação Agrária e Veterinária
INR	National Wastes Institute	Instituto Nacional de Resíduos
INRA	National Institute for Agronomic Investigation (France)	Institut National de la Recherche Agronomique (França)
INRB	National Institute of Biological Resources (changed to INIAV)	Instituto Nacional de Recursos Biológicos
IPCC	Intergovernmental Panel on Climate Change	-
IPMA	Portuguese Sea and Atmosphere Institute	Instituto Português do Mar e da Atmosfera
ISP	Portuguese Insurance Institute	Instituto de Seguros de Portugal
IST-UTL	Technical Superior Institute – Lisbon Technical University	Instituto Superior Técnico – Universidade Técnica de Lisboa
JP	Jet Fuel	-



Acronym	English	Portuguese
LCP	Large Combustion Plants (the same as GIC)	o mesmo que GIC
LDPE	Low Density Poly Ethylene	Polietileno de Baixa Densidade (PEBD)
LDV	Light Duty Vehicles	Veículos Ligeiros de Mercadorias
LNG	Liquefied Natural Gas	Gás Natural Liquefeito
LOSP	Light Organic Solvent-based Preservatives	-
LQARS	Agriculture Chemical Laboratory Rebelo da Silva (integrated in INIAV)	Laboratório Químico Agrícola Rebelo da Silva
LPS	Large Point Sources (Corinair definition)	Grandes Fontes Poluidoras
LRTAP	Long-range Transboundary Air Pollution	Poluição Atmosférica Transfronteiras a Longa Distância
LTO	Landing and Take-off	Aterragens e Descolagens
LUCF	Land-use Change and Forestry	Alteração do Uso do Solo e Florestas
LULUCF	Land Use, Land-use Change and Forestry	Uso do Solo, Alteração do Uso do Solo e Florestas
MA	Ministry of Environment	Ministério do Ambiente
MAC	Mobile Air-conditioning systems	-
MADRP	Ministry of Agriculture, Rural Development and Fisheries (changed to MAMAOT)	Ministério da Agricultura, Desenvolvimento Rural e Pescas (changed to MAMAOT)
MAM	Ministry of Agriculture and Sea	Ministério da Agricultura e do Mar
MAMAOT	Ministry for Agriculture, Sea, Environment and Land Use Planning (changed to MAM)	Ministério da Agricultura, do Mar, do Ambiente e do Ordenamento do Território
MAOT	Ministry of Environment and Land Use Planning (changed to MAMAOT)	Ministério do Ambiente e Ordenamento do Território (changed to MAMAOT)
MCF	Methane Conversion Factor	Factor de Conversão de Metano
MCOTA	Ministry of Urban Affairs, Land Use Planning and Environment (older name of Ministry of Environment)	Ministério das Cidades, Ordenamento do Território e Ambiente (older name of Ministry of Environment)
MDI	Metered Dose Inhalers	-
MEET	Methodologies For Estimating Air Pollutant Emissions From Transport	-
MMS	Manure Management Systems	Sistema de Gestão de Estrumes
MSW	Municipal Solid Wastes	Resíduos Sólidos Municipais
MTBE	Methyl Tertiary Butyl Ether	Metil-Ter-Butil-Éter
Na ₂ S	Sodium Sulphide	Sulfureto de Sódio
NaOH	Sodium Hydroxide	Hidróxido de Sódio
NAPFUE	Corinair Fuel Nomenclature	
NATO	North Atlantic Treaty Organisation	Organização do Tratado do Atlântico Norte
NAV	National Entity responsible for air traffic	Navegação Aérea
NCV	Net Calorific Value	-
NFI	National Forestry Inventories	Inventário Florestal Nacional
NFR	New Format Reporting	-
NH ₃	Ammoniac	Amoníaco
NMVOC	Non Methane Volatile Organic Compounds	Compostos Orgânicos Voláteis Não Metânicos (COVNM)
NO _x	Nitrogen Oxides (NO + NO ₂)	Óxidos de Azoto (NO+NO ₂)
NPK	Nitrogen, Phosphorus and Potassium	Nitrogénio, Fósforo e Potássio



Acronym	English	Portuguese
NSS	Normal Super Phosphates	Superfosfatos simples
NUTS (0..III)	Nomenclature of Territorial Units for Statistics	Nomenclatura de Unidades Territoriais para fins estatísticos
OD	Origin - Destiny	Origem - Destino
ODS	Ozone Depleting Substances	-
OECD	Organization for Economic Co-operation and Development	Organização para a Cooperação e Desenvolvimento Económico (OCDE)
OX	Oxidation Factor	Factor de Oxidação
PAF	Forestry Action Program	Programa de Acção Florestal
PAH	Polycyclic Aromatic Hydrocarbons	Hidrocarbonetos Aromáticos Policíclicos
PCI	Low Heating Value (LHV)	Poder Calorífico Inferior
PDM	Methodological Development Plan	Plano de Desenvolvimento Metodológico
PEN	National Energetic Program	Plano Energético Nacional
PER	Perchloro-ethylene	Percloroetileno
PERSU	Strategic Plan on Municipal Solid Wastes	Plano Estratégico dos Resíduos Sólidos Urbanos
PETROGAL	Portuguese Petroleum Company	Empresa de Petróleos de Portugal
PFC	Perfluorinated Hydrocarbons	-
PM1	Particles with Aerodynamic Diameter smaller than 1 micrometre	Partículas cujo diâmetro aerodinâmico é inferior a 1 micrómetro
PM10	Particles with Aerodynamic Diameter smaller than 10 micrometres	Partículas cujo diâmetro aerodinâmico é inferior a 10 micrómetros
PM2.5	Particles with Aerodynamic Diameter smaller than 2.5 micrometres	Partículas cujo diâmetro aerodinâmico é inferior a 2.5 micrómetros
PNAC	National Climate Change Program	Programa Nacional para as Alterações Climáticas
PNPA	National Plan for Environmental Policy	Plano Nacional da Política de Ambiente
PP	Poly Propylene	Polipropileno
PS	Poly Styrene	Poliestireno
PTEN	National Emission Ceilings Program	Programa para os Tectos de Emissão Nacional
PVC	Poly Vinyl Chloride	Cloreto de Polivinil
RA	Agricultural Region	Região Agrária
RCM	Council Minister's Resolution	Resolução do Conselho de Ministros
REN	National Electric System	Rede Eléctrica Nacional
RVP	Reid Vapour Pressure	Pressão de Vapor de Reid
SF6	Sulphur Hexafluoride	Hexafluoreto de Enxofre
SNIERPA	National System of Inventories of Emissions and Removals of Atmospheric Pollutants	Sistema Nacional de Inventários de Emissões e Remoções de Poluentes Atmosféricos
SOx	Sulphur Oxides	Óxidos de Enxofre
SW	Solid Wastes	Resíduos Sólidos
SWDS	Solid Waste Disposal Sites	Locais para Deposição de Resíduos Sólidos
TANKS	Software designed to estimate air emissions from organic liquids in storage tanks (USEPA, September 27, 2001)	Software criado para a estimativa de emissões atmosféricas a partir de líquidos orgânicos em tanques de armazenamento (USEPA, 27 de Setembro de 2001)
TNT	Trinitrotoluene	Trinitrotolueno



Acronym	English	Portuguese
TOE	Tons of oil equivalent	Toneladas Equivalentes de Petróleo (TEP)
TOW	Total Organic Waste	Resíduo Orgânico Total
TRANSGÁS	Portuguese Company of Natural Gas	Sociedade Portuguesa de Gás Natural (Empresa)
TSP	Total Suspended Particles	Partículas Totais em Suspensão
TSS	Triple Super Phosphates	Superfosfatos Triplos
UNECE	United Nations Economic Commission for Europe	-
UNFCCC	United Nations Framework Convention on Climate Change	Convenção Quadro das Nações Unidas para as Alterações Climáticas
USEPA	United States Environmental Protection Agency	Agência de Protecção Ambiental dos Estados Unidos da América
VCM	Vinyl Chloride Monomer	Monómero de Cloreto de Vinilo
VOC	Volatile Organic Compounds	Compostos Orgânicos Voláteis
VRF	Vacuum Residual Fuel Oil	Resíduo de Alto Vácuo
WWH	Wastewater Handling	Tratamento de Águas Residuais
ZA	Agricultural Zone	Zona Agrária

REFERENCES

- ACAP, 2003. Estatísticas do Sector Automóvel. Associação do Comércio Automóvel de Portugal.
- AFN (1982, 1995, 2005) – National Forestry Inventories.
- AFN, 2009a. Série temporal de dados de área ardida. Autoridade Florestal Nacional, Lisboa (Conceição Ferreira, com. pessoal).
- AFN, 2009b. Volume cortado 2004-2006 para coníferas e não coníferas. Autoridade Florestal Nacional, Lisboa (Conceição Ferreira, com. pessoal).
- AFN (2010). Inventário Florestal Nacional de Portugal Continental IFN5 2005-2006.
- Almeida, Domingos, 2006. Manual de Culturas Hortícolas, Volume I e II.
- ANA, 2003. Estatísticas do Tráfego Aéreo 2002. ANA – Aeroportos de Portugal.
- APED, 1999. Anuário da Distribuição Portuguesa 1999.
- BEMA - 1997, Biogenic Emissions in the Mediterranean Area, Atmospheric Environment, Special issue 31-S1,1-256
- BHF - Centro Federal de Investigação Florestal (2000) - Estado das Florestas na Europa. Relatório de Síntese de ONU/CEE e CE, Genebra e Bruxelas.
- Bossard, M., Feranec, J. & J. Otahel, 2000. CORINE land cover technical guide – Addendum 2000. EEA Technical Report nº 40. Environmental European Agency. Copenhagen
- Büttner, G., G. Feranec and G. Jaffrain, 2006. CORINE Land Cover nomenclature illustrated guide - addendum 2006, available online at http://www.igeo.pt/gdr/en/index.php?princ=Projects/CLC2006&sessao=m_projectos
- Caetano, M., A. Araújo, A. Nunes, V. Nunes and M. Pereira, 2009a. Accuracy assessment of the CORINE Land Cover 2006 map of Continental Portugal, Technical Report, Instituto Geográfico Português, available online at http://www.igeo.pt/gdr/en/index.php?princ=Projects/CLC2006&sessao=m_projectos (last accessed 5 April 2011).
- Caetano, M., A. Nunes and V. Nunes, 2007. Manual de apoio à produção do CLC2006 para Portugal Continental, Technical report, Instituto Geográfico Português.
- Caetano, M. e Pereira, M. 2007. Proposta de trabalhos para o Instituto Geográfico Português no estudo piloto para definição da metodologia a adoptar por Portugal para prestação de informação no âmbito do sector LULUCF da UNFCCC e do Protocolo de Quioto, relatório técnico, Instituto Geográfico Português.
- Caetano, M., Araújo, A. e Nunes, V. 2008a. Proposta de conversão da nomenclatura da COS'90 para a da COS2007 - Relatório final (versão 6.0), relatório técnico, Instituto Geográfico Português.
- Caetano, M., Carrão H. & M. Painho, 2005. Alterações da ocupação do solo em Portugal Continental: 1985 - 2000, Instituto do Ambiente, Lisboa.
- Caetano, M., M. Pereira, H. Carrão, A. Araújo, A. Nunes and V. Nunes, 2008. Cartografia temática de ocupação/uso do solo do Instituto Geográfico Português. Mapping - Revista Internacional de Ciencias de la Tierra Nº 126, pp. 78-87.



- Caetano, M., Nunes, V and Pereira, M. 2009c. Land Use and Land Cover Map of Continental Portugal for 2007 (COS2007): project presentation and technical specifications development. 3rd Workshop of the EARSeL Special Interest Group on Land Use and Land Cover, 25 - 27 November 2009, Bonn, Germany, in press.
- Caetano, M., Nunes, V. and Nunes, A. 2009b. CORINE Land Cover 2006 for Continental Portugal, technical report, Instituto Geográfico Português.
- Caetano, M., Nunes, V. e Araújo, A. 2009a. Manual da COS2007 - Carta de Uso e Ocupação do Solo de Portugal Continental para 2007 (versão preliminar 2.16), relatório técnico, Instituto Geográfico Português.
- Caetano, M., Pereira, M., Carrão, H., Araújo, A., Nunes, A. e Nunes, V. 2008b. Cartografia temática de ocupação/uso do solo do Instituto Geográfico Português. Mapping - Revista Internacional de Ciencias de la Tierra, nº 126, pp. 78-87.
- Carreira, 2002. Fluorocarbonetos – Actividade 2001, AIR LIQUIDE
- Cartaxo et al, 1985. Determinação das cargas poluidoras brutas produzidas pelos sectores de actividade industrial em Portugal Continental. Ministério do Equipamento Social. Direcção-geral dos Recursos e Aproveitamentos Hidráulicos. Direcção de Serviços de Controle da Poluição.
- Carvalho, M.J. e G. Basch (1995): Effects of traditional and no-tillage on physical and chemical properties of a Vertisol. Proceedings of the EC-Workshop - II - on no-tillage crop production in the West-European Countries, Silsoe, May 1995, 2, 17 – 23, F. Tebrügge, A. Böhrnsen (ed.), Wissenschaftlicher Fachverlag, Giessen.
- Carvalho, J., 2000. Crescimento, Produção e Ecologia de Povoamentos de *Quercus pyrenaica* Wild em Portugal Continental. PhD Thesis. Universidade de Trás-os-Montes e Alto Douro, Vila Real, Portugal.
- Carvalho, M., Basch, G., Brandão, M., Santos, F., Figo, M. (2002). A sementeira directa e os resíduos das culturas no aumento do teor de matéria orgânica do solo e na desposta da cultura de trigo à adubação azotada. Proceedings of 1º Congresso Nacional de Mobilização de Conservação do Solo, APOSOLO, Évora.
- Carvalho, M., Basch, G., Calado, J.M.G., Barros, J.F.C. (2012). Long Term Effects of Tillage System and Crop Residue Management on Soil Carbon Content of a Luvisol under Rainfed Mediterranean Conditions. Special Issue Striving for Sustainable High Productivity through Improved Soil and Crop Management. Revista Científica de la Facultad de Agronomía, Universidad de la República, y del Instituto Nacional de Investigación Agropecuaria. ISSN 1510-0839
- CEC, 1992. CORINAIR Inventory. Default Emission Factors Handbook. 2nd ed. Comission of the European Comission.
- Coelho, M. B. & Godinho, J. M., 2002. SUBER DATA 2 - Base de dados de sobreiro - Manual para o utilizador. Publicações GIMREF, RT8/2002. Departamento de Engenharia Florestal, Instituto Superior de Agronomia, Lisboa.
- Correia, A., Faias, S., Tomé, M., Evangelista, M., Freire, J., Carvalho, P.O. (2008) Ajustamento simultâneo de equações de biomassa de Pinheiro Manso no Sul de Portugal. *Silva Lusitana* 16 (2): 197-205
- COSTA, J. B. (1985) – Caracterização e constituição do solo, 3ª Ed. FCGulbenkian, Lisboa.
- CPPE, 2000 - Companhia Portuguesa de Produção de Electricidade, 2001. Relatório de Ambiente 2000.
- Cunha, P. P., Lemos de Sousa, M. J., Pinto de Jesus, A., Rodrigues, C. F., Telles Antunes. M. e Tomás (2012) - *Coal in Portugal: Geology, Petrology and Geochemistry*.
- de VRIES, W., G.J. REINDS, M. KERKVOORDE, (2000) - Intensive monitoring of forest ecosystems in Europe, Technical Report 2000 / UN/ECE & EC Forest Intensive.



Dias, J.J. Mestre (2002) - Utilização da biomassa: avaliação dos resíduos e utilização de pellets em caldeiras domésticas.

DGE, 2003. Energy in Portugal. The 1990s. Direcção-Geral de Energia. Statistical Division (Eurostat file nº 200245501003).

DGRF, 2006. Manual de instruções para a realização do trabalho de fotointerpretação – 5º Inventário Florestal Nacional. Direcção Geral dos Recursos Florestais, Lisboa, Portugal (publicação interna).

Direcção-Geral das Florestas, 2001. Inventário Florestal Nacional – Portugal Continental – 3ª Revisão, 1995-1998, Relatório Final

Direcção-Geral de Energia, 1989. Informação Energia nº14. Direcção de Serviços e Planeamento e Assuntos Económicos e Divisão de Estatística.

Direcção-Geral de Energia, 1990. Informação Energia nº15. Direcção de Serviços e Planeamento e Assuntos Económicos e Divisão de Estatística.

Direcção-Geral de Energia, 1991. Informação Energia nº16. Direcção de Serviços e Planeamento e Assuntos Económicos e Divisão de Estatística.

Direcção-Geral de Energia, 1992. Informação Energia nº17. Direcção de Serviços e Planeamento e Assuntos Económicos e Divisão de Estatística.

Direcção-Geral de Energia, 1993. Informação Energia nº18. Direcção de Serviços e Planeamento e Assuntos Económicos e Divisão de Estatística.

Direcção-Geral de Energia, 1994. Informação Energia nº19. Direcção de Serviços e Planeamento e Assuntos Económicos e Divisão de Estatística.

Direcção-Geral de Energia, 1995. Informação Energia nº20. Direcção de Serviços e Planeamento e Assuntos Económicos e Divisão de Estatística.

Direcção-Geral de Energia, 1996. Informação Energia nº21. Direcção de Serviços e Planeamento e Assuntos Económicos e Divisão de Estatística.

Direcção-Geral de Energia, 1997. Informação Energia nº22. Direcção de Serviços e Planeamento e Assuntos Económicos e Divisão de Estatística.

Direcção-Geral de Energia, 1998. Informação Energia nº23. Direcção de Serviços e Planeamento e Assuntos Económicos e Divisão de Estatística.

Direcção-Geral de Energia, 1999. Informação Energia nº24. Direcção de Serviços e Planeamento e Assuntos Económicos e Divisão de Estatística.

Direcção-Geral de Energia, 2000. Informação Energia nº25. Direcção de Serviços e Planeamento e Assuntos Económicos e Divisão de Estatística.

Direcção-Geral de Energia, 2001. Informação Energia nº26. Direcção de Serviços e Planeamento e Assuntos Económicos e Divisão de Estatística.

Direcção-Geral de Energia, 2002. Balanços Energéticos - Séries Temporais 1990-2000.

Direcção-Geral de Energia, 2003. Energy in Portugal. The 1990s. Statistical Division (Eurostat file nº 200245501003).

EAPA, 2002. ASphalt in Figures. European Asphalt Pavement Association. Breukelen. The Netherlands.

EDP - Electricidade de Portugal, 2000. Relatório de Ambiente 1999.



- EDP - Electricidade de Portugal, 2001. Relatório de Ambiente 2000.
- EDP - Electricidade de Portugal, 2002. Emissões Atmosféricas das Centrais do SEP - Previsões para 2002.
- EDP-Electricidade de Portugal, 2002. Relatório de Ambiente 2001.
- EDP-Electricidade de Portugal, 2003. Relatório de Ambiente 2002 - Ambiente e Sociedade.
- EDP-Electricidade de Portugal, 2004. Relatório de Ambiente 2003 - Ambiente e Sociedade.
- EEA, 2002. EMEP/CORINAIR Emission Inventory Guidebook - 3rd edition October 2002 UPDATE Technical report No 30, Environment European Agency.
- EEA, 2002b. CORINE Land Cover Update. I&LC2000 Project. Technical Guidelines. Copenhagen
- Eggleston H.S., 1992, An Improved UK Ammonia Emission Inventory. In Proceedings of a workshop: Ammonia Emissions in Europe: emission coefficients and abatement costs, Laxenburg, Austria, February 4-6 1991, Klassen G., ed., IIASA, Laxenburg, Austria, pp. 95-107.
- EMEP/CORINAIR, 1996. Atmospheric Emission Inventory Guidebook (first edition). EMEP Task Force on Emission Inventories. European Environment Agency. Copenhagen.
- EMEP/EEA Emission Inventory Guidebook (2009), Chapter 11b forest fires.
- EMEP/EEA Emission Inventory Guidebook (2013).
- EMEP/EEA air pollutant emission inventory guidebook (2016)
- EPA, 2001. Inventory of U.S. Greenhouse Gas Emissions and Sinks: 1990-1999
- EPA, 2002. Inventory of U.S. Greenhouse Gas Emissions and Sinks: 1990-2000
- European Commission, 1994. Corinair. Technical annexes. Volume 2. Default Emission Factors Handbook. Directorate-General Environment, Nuclear Safety and Civil Protection. 327 pp
- FAA, Federal Aviation Administration Aircraft Engine Emission User Guide and Database (AEE-110). Office of Environment and Energy within the Federal Aviation Administration
- Faias, S., 2009. Analysis of Biomass Expansion Factors for the Most Important Species in Portugal. Master thesis. Instituto Superior de Agronomia, Universidade Técnica de Lisboa, Lisboa, Portugal.
- Faias, S.P. (2009) Analysis of Biomass Expansion Factors for the most important tree species in Portugal. Dissertação para obtenção do Grau de Mestre em Engenharia Florestal e dos Recursos Naturais, Instituto Superior de Agronomia.
- FAO, 2001. Lecture Notes on the Major Soils of the World. FAO Agriculture Department. Rome (<http://www.fao.org/docrep>)
- Fresenius, W., Schneider, W. Bohnke, B., Poppinghaus, K. (editors), *Waste Water Technology: Origin, Treatment, and Analysis of Waste Water*, Deutsche Gesellschaft für Technische Zusammenarbeit, Springer-Verlag, Berlin, Heidelberg, 1989.
- GDR (Grupo de Detecção Remota) 2009. CLC2006 - CORINE Land Cover 2006 for Continental Portugal. Available online at: <http://www.igeo.pt/gdr/en/projects/clc2006/> (last accessed 15 January 2010).
- Geron, C.D., A.B. Guenther and T.E. Pierce - 1994, An Improved Model for Estimating Emissions of Volatile Organic Compounds from Forests in the Eastern United States, J. Geophys. Res. 99 (D6) 12773-12791.
- Gonçalves, J. 2008a. Conversões de coordenadas com o programa PROJ – Método de conversão com grelhas. Primeiras Jornadas de Software Aberto para Sistemas de Informação Geográfica SASIG I, 20 – 22 Outubro



2008, Águeda, Portugal. Disponível online em: <http://gfoss.sigaberto.org/wp-content/uploads/2008/11/sasig2008.pdf> (último acesso em 23 Outubro 2009).

Gonçalves, J. 2008b. Grelhas no formato NTv2. Disponível online em: <http://www.fc.up.pt/pessoas/jagoncal/coordenadas/parte1.htm> (último acesso em 23 Outubro 2009).

GT SNIERPA 3.3/3.4 (Grupo de Trabalho do SNIERPA para o Artigo 3, Parágrafos 3 e 4, do Protocolo de Quioto) 2008. Acta da reunião de 12 de Fevereiro de 2008, meeting minutes, Agência Portuguesa do Ambiente.

GT SNIERPA 3.3/3.4 (Grupo de Trabalho do SNIERPA para o Artigo 3, Parágrafos 3 e 4, do Protocolo de Quioto) 2007a. Acta da reunião bilateral APA-IGP de 17 de Dezembro de 2007 (versão preliminar), meeting minutes, Agência Portuguesa do Ambiente.

GT SNIERPA 3.3/3.4 (Grupo de Trabalho do SNIERPA para o Artigo 3, Parágrafos 3 e 4, do Protocolo de Quioto) 2007b. Acta da reunião de 27 de Setembro de 2007 (versão preliminar), meeting minutes, Agência Portuguesa do Ambiente.

GT SNIERPA 3.3/3.4 (Grupo de Trabalho do SNIERPA para o Artigo 3, Parágrafos 3 e 4, do Protocolo de Quioto) 2007c. Acta da reunião de 17 de Julho de 2007, meeting minutes, Agência Portuguesa do Ambiente.

GT SNIERPA 3.3/3.4 (Grupo de Trabalho do SNIERPA para o Artigo 3, Parágrafos 3 e 4, do Protocolo de Quioto) 2009. Acta da reunião de 15 de Julho de 2009, Agência Portuguesa do Ambiente.

GT SNIERPA 3.3/3.4 (Grupo de Trabalho do SNIERPA para o Artigo 3, Parágrafos 3 e 4, do Protocolo de Quioto) 2008a. Acta da reunião de 12 de Fevereiro de 2008, Agência Portuguesa do Ambiente.

GT SNIERPA 3.3/3.4 (Grupo de Trabalho do SNIERPA para o Artigo 3, Parágrafos 3 e 4, do Protocolo de Quioto) 2008b. Acta da reunião de 27 de Outubro de 2008, Agência Portuguesa do Ambiente.

Guenther, A., Nicholas Hewitt, N., David Erickson, Ray Fall, Chris Geron, Tom Graedel, Peter Harley, Lee Klinger, Manuel Lerdau, W.A. McKay, Tom Pierce, Bob Scholes, Rainer Steinbrecher, Raja Tallamraju, John Taylor and Pat Zimmerman - 1995, A Global Model of Natural Volatile Organic Compound Emissions, *J. Geophys. Res.*, 100(D5), 8873-8892.

Guenther, A., Zimmerman, P.R., Harley, P. And Wildermuth, M. - 1994, Natural Volatile Organic Compound Emission rate estimates for U.S. Woodland landscapes, *Atmos. Environ.*, 28, 1197-1210

IA (Instituto do Ambiente) 2006. Portuguese initial report under the Kyoto Protocol - Report to facilitate the calculation of the assigned amount pursuant to Article 3, paragraphs 7 and 8, of the Kyoto Protocol (submission to the UNFCCC Secretariat), technical report.

IA (Instituto do Ambiente) 2006. Portuguese initial report under the Kyoto Protocol - Report to facilitate the calculation of the assigned amount pursuant to Article 3, paragraphs 7 and 8, of the Kyoto Protocol (submission to the UNFCCC Secretariat), technical report.

ICAO, 1989. ICAO Engine Exhaust Emission Databank. ICAO Committee on Aviation Environmental Protection Working Group 3 meeting, Mariehamn, Aland. October 10-13, 1989.

ICNF (2001-2012). Informação sobre áreas ardidadas e ocorrências de 2001 a 2012. <http://www.icnf.pt/portal/florestas/dfci/relat/rel-if>

IGP (Instituto Geográfico Português) 2002. Área coberta pela Carta de Ocupação do Solo - COS'90. Available online at: http://www.igeo.pt/produtos/CEGIG/cos_cartograma.htm (last accessed 15 January 2010).

INCM (Imprensa Nacional – Casa da Moeda) 2005. Resolução do Conselho de Ministros n.º 68/2005, de 17 de Março. Diário da República, série I-B, n.º 54. Available online at: <http://dre.pt/pdf1sdip/2005/03/054B00/23712374.PDF> (last accessed 9 April 2008).



INRA, 1984. Alimentation de Los Animales Monogastricos. Cerdo, Conejo, Aves. Ed. Mundi-Prensa, Madrid, 1985

IPCC (The Intergovernmental Panel on Climate Change) 2003. Good practice guidance for land use, land-use change and forestry, Institute for Global Environmental Strategies. Available online at: http://www.ipcc-nggip.iges.or.jp/public/gpplulucf/gpplulucf_contents.htm

IPCC (The Intergovernmental Panel on Climate Change) 2003. Good practice guidance for land use, land-use change and forestry, Institute for Global Environmental Strategies. Available online at: http://www.ipcc-nggip.iges.or.jp/public/gpplulucf/gpplulucf_contents.htm (last accessed 9 April 2008).

IPCC, 1995. IPCC Guidelines for National Greenhouse Gas Inventories. Volume 2 - Workbook. United Nations Environment Programme (UNEP), the Organization for Economic Co-operation and Development (OECD), the International Energy Agency (IEA) and the Intergovernmental Panel on Climate Change (IPCC).

IPCC, 1995b. IPCC Guidelines for National Greenhouse Gas Inventories. Volume 3 - Reference Manual. United Nations Environment Programme (UNEP), the Organization for Economic Co-operation and Development (OECD), the International Energy Agency (IEA) and the Intergovernmental Panel on Climate Change (IPCC).

IPCC, 1997. Revised 1996 IPCC Guidelines for National Greenhouse Gas Inventories. Volume 2 - Workbook. The Intergovernmental Panel on Climate Change (IPCC), the Organization for Economic Co-operation and Development (OECD) and the International Energy Agency (IEA).

IPCC, 1997b. Revised 1996 IPCC Guidelines for National Greenhouse Gas Inventories. Volume 3 - Reference Manual. The Intergovernmental Panel on Climate Change (IPCC), the Organization for Economic Co-operation and Development (OECD) and the International Energy Agency (IEA).

IPCC, 2000. Good Practice Guidance and Uncertainty Management in National Greenhouse Gas Inventories. The Intergovernmental Panel on Climate Change (IPCC).

IPCC, 2003. Good Practice Guidance for Land Use, Land-Use Change and Forestry. The Intergovernmental Panel on Climate Change (IPCC).

IPCC (2006). Guidelines for National Greenhouse Gas Inventories.

IPCC/OECD, 1994. IPCC Draft Guidelines for National Greenhouse Gas Inventories. Volume 2 - Workbook. IPCC/OECD Joint Programme.

IPCC/OECD, 1994b. IPCC Draft Guidelines for National Greenhouse Gas Inventories. Volume 3 - Reference Manual. IPCC/OECD Joint Programme.

ISR, Departamento de Engenharia Electrotécnica e de Computadores, Universidade de Coimbra, 24 de Marco de 2006. EFIPRE Eficiência Energética e Integração Sustentada de PRE-Biogás.

Jarrige, R., 1988. Alimentation des Bovins, Ovins et Caprins, INRA, Parisa.

Kauppi, P.E., K. Mielikainen & K. Kuusela (1992) - Biomass and carbon budget of European forests, 1971, Science 256:70-74.

LQARS, 2000. Manual de Fertilização das Culturas. Laboratório Químico Agrícola Rebelo da Silva, Lisboa.

Luchetta, L., V. Simon and L. Torres - 1999 (confirmar data), Estimation of the Yeraly Emission of non-methanic Volatile Organic Compounds (VOCs) from the Forest Ecosystem in France.

Luz, A., Nunes, A. e Caetano, M. 2008. Proposta metodológica para a correcção das distorções geométricas da COS'90: resultados preliminares. X Encontro de Utilizadores de Informação Geográfica (ESIG 2008), 14 - 16 Maio 2008, Oeiras, Portugal, in press.



MADRP/DGPC (MINISTÉRIO DA AGRICULTURA, DO DESENVOLVIMENTORURAL E PESCAS/ DIRECÇÃO-GERAL DE PROTECÇÃO DAS CULTURAS), 2006. Requisitos Mínimos para o Exercício da Produção Integrada.

Martins, A. A. A. (1992) – Génese e evolução de solos derivados de granitos / Estudo de uma climo-sequência no norte de Portugal, Tese PhD em Engenharia Agrícola, UTAD, Vila Real.

McDonald, P., Edwards, R.A., Greenhalgh, J.F.D. Et C.A. Morgan, 2002. Animal Nutrition. Prentice Hall, Harlow.

Menegon, G., Pivotti, F. & G. Xiccato, 1985. Fundamentos de Tecnologia Agrária. 2º Volume. Publicações Europa-América.

Ministerio de Medio Ambiente, y Medio Rural y Marino (2011) - Inventario de emisiones de gases de efecto invernadero de España años 1990-2009. Comunicación a la comisión europea.

Montero, G., Ruiz-Peinado, R. Muñoz, M (2005) Producción de biomasa y fijación de CO2 por los bosques españoles. INIA 220: 25-36.

Montero, G., Ruiz-Peinado, R., & Muñoz, M., 2005. Producción de biomassa y fijación de CO2 por los bosques españoles. In Coléccion Monografías INIA. Serie Forestal nº13. Instituto Nacional de Investigaciones Agrarias, Ministerio de Agricultura, Madrid, Espanha.

Mueller-Edzards, C., W. de Vries & J.W. (1997) - Ten years of monitoring forest condition in Europe -, Technical Background Report / UN/ECE & EC: 211-224, Geneva – Brussels.

Nery, F. 2007. Sobre a avaliação da conformidade da Carta de Ocupação do Solo de 1990, relatório de projecto, Projecto MUBISPI [POCTI/42351/GEO/2001].

Nery, F. e Marrecas, P. 2003. Avaliação de qualidade da Carta de Ocupação do Solo de Portugal Continental de 1990, relatório de projecto, Projecto MUBISPI [POCTI/42351/GEO/2001].

Nunes, T.V. - 1996, Biogenic Emissions of non-methane hydrocarbons. Contribution to the evaluation of VOC emission rates by portuguese ecosystems (in Portuguese). Ph. Thesis, University of Aveiro, Portugal.

Nunes, T.V. And C.A. Pio - 1999, Emission of Volatile Organic Compounds from Portuguese Eucalyptus Forests.

Oliveira, Arlinda Leal Franco de (1967) - Estudo da matéria orgânica nas unidades de solos cartografados em Portugal (a sul do rio Tejo), Sec. Est. Agricultura / DGSFA, Lisboa.

Olson, J.S. (1963). Energy storage and the balance of producers and decomposers in ecological systems. Ecology 44 (2): 322-331. Quoted in Rosa (2009).

Painho, M. & M. Caetano, 2006. Cartografia de ocupação do solo. Portugal continental 1985-2000 CORINE Land Cover 2000, Instituto do Ambiente, Amadora, available at: http://www.igeo.pt/gdr/index.php?princ=PROJECTOS/CLC2000&sessao=m_projectos

Páscoa, F., 1987. Estrutura, Crescimento e Produção em Povoamentos de Pinheiro Bravo. Um Modelo de Simulação. PhD Thesis. Instituto Superior de Agronomia, Universidade Técnica de Lisboa, Lisboa, Portugal.

Patrício, Maria S.F. 2006. Análise da potencialidade produtiva do castanheiro em Portugal. PhD Thesis. Departamento de Engenharia Florestal, Instituto Superior de Agronomia, Lisboa, Portugal.

Pereira et al, 2002. Quantificação dos Sumidouros Terrestres de Carbono em Portugal Continental. Universidade Técnica de Lisboa - Instituto Superior de Economia.

Pereira, M., Luz, A. and Caetano, M. 2008. Pilot study for defining Portugal's reporting methodology under the UNFCCC and the Kyoto Protocol, in the LULUCF sector (Final report of work package WP10 - Portuguese Geographic Institute), technical report, Instituto Geográfico Português.



- Pereira, M^a Conceição and Caetano, M., 2008. Pilot study for defining Portugal's reporting methodology under the UNFCCC and the Kyoto Protocol, in the LULUCF sector, IGP.
- Pereira, T. C., Seabra, T., Maciel, H. & Torres, P., 2009. Portuguese National Inventory Report on Greenhouse Gases, 1990-2007 Submitted under the United Nations Framework Convention on Climate Change and the Kyoto Protocol. Portuguese Environmental Agency. Amadora.
- Pereira, J., Figueiredo, N., Goufo, P., Carneiro, J., Morais, R., Carranca, C., Coutinho, J and Trindade, H , 2013 – Effects of elevated temperature and atmospheric carbon dioxide concentration on the emissions of methane and nitrous oxide from Portuguese flooded rice fields – *Atmospheric Environment* 80 (2013)464-471.
- Pio, C.A. And A.A. Valente - 1998, Atmospheric Fluxes and Concentrations of Monoterpenes in Resin-Tapped Pine Forests, *Atmosph. Env.* Vol 32 nº 4, 683-691.
- Pio, C.A., Nunes, T.V. And A.R. Valente - 1999 (Confirmar data), Emission of Volatile Organic Compounds from Portuguese Maritime Pine Forests, Universidade de Aveiro, Portugal.
- PNAC, 2003. Medidas Adicionais Visando o Cumprimento do Protocolo de Quioto, Documento de trabalho.
- PNALE, 2004. Plano Nacional de Atribuição de Licenças de Emissão de CO₂ (PNALE) 2005-2007, Grupo de Trabalho PNALE.
- PTEN, 2002. Programa para os Tectos de Emissão Nacional - Estudos de Base - Cenário de Referência, Departamento de Ciências e Engenharia do Ambiente da Faculdade de Ciências e Tecnologia da Universidade Nova de Lisboa - Instituto do Ambiente - Centro de Estudos em Economia da Energia, dos Transportes e Ambiente.
- Razquin, M. C., O Porco e a sua alimentação razional, Biblioteca Agrícola Litexa, Lisboa, 1975.
- REN-Rede Eléctrica Nacional, 2003. Emissões Atmosféricas das Centrais do SEN - Previsões para 2003.
- Rosa, I (2009). Estimativa das emissões de gases com efeito de estufa resultantes de fogos de vegetação em Portugal. Dissertação para a obtenção do Grau de Mestre em Engenharia Florestal e Gestão dos Recursos Naturais. Instituto Superior de Agronomia.
- Rosário, L. (2009) - Referências para a avaliação do sequestro de carbono nos solos portugueses com base na rede ICP Forest e LQARS.
- Rosário, L.; Ferreira, C; Avelar, T.; Paulino, J. e Pina, A: (2010) - Bases para a avaliação do sequestro e sinks de carbono orgânico total nos solos florestais e agrícolas Portugueses – Dados da Rede ICP Forest (1995), LQARS (1999) e Projecto BioSoil (2005).
- Sánchez-González, M. S., Tomé, M. & Montero, G., 2005. Modelling height and diameter growth of dominant cork oak trees in Spain. *Annals of Forest Science*, 62:633-643.
- Schulze, E.D. (ed) (2000) - Carbon and nitrogen cycling in Europe forest, *Ecological Studies* 142, in press, Springer Verlag, Hiedelberg.
- Seixas, J., V. Gois, F. Ferreira, R. Diniz, F. Moura, P. Torres, C. Furtado, S. Martinho, P. Matos, S. Fava, M. Remédio e J. Gonçalves, 2000. Emissão e Controlo de Gases com Efeito de Estufa em Portugal. Ministério do Ambiente e Ordenamento do Território, GASA-DCEA-FCT, Março 2000.
- Silva, P., T. Nunes, C. Campos, M. Mariz and C.Pio - 1999, Emissões de Compostos Orgânicos Voláteis pela Floresta de Sobreiro em Portugal, 6^a Conferência Nacional sobre a Qualidade do Ambiente, 627-637, 1999.
- Silva, T.P., Pereira, J.M.C., Paúl, J.C.P, Santos, M.T.N., Vasconcelos, M.J.P. (2006) Estimativa de emissões atmosféricas originadas por fogos rurais em Portugal. *Silva Lusitana* 14 (2): 239-263.



Simpson - 1996, Inventorying Biogenic VOC Emissions in Europe, EMEP MSC-W, Norwegian Meteorological Institute, Oslo.

Simpson, D., Alex Guenther, C. Nicholas Hewitt and Rainer Steinbrecher - 1995. Biogenic Emissions in Europe. 1. Estimates and Uncertainties, *J. Geophys. Res.*, 100 (D11), 22875-22890.

Simpson, D., Wilfried Winiwarter, Gynnar Borjesson, Steve Cinderby, Antonio Ferreiro, Alex Guenther, C. Nicholas Hewitt, Robert Janson, M. Aslam K. Khalil, Susan Owen, Tom E. Pierce, Hans Puxbaum, Martha Shearer, Ute Skiba, Rainer Steinbrecher, Leonor Tarrasón and Mats H. Oquist - 1999. Inventorying emissions from nature in Europe, *J. Geophys. Res.*, 104 (D7), 8113-8152.

Soares, P., Oliveira, T. & Tomé, M., 2006. O Modelo Globulus 3.0. Publicações GIMREF, RC2/2006. Departamento de Engenharia Florestal, Instituto Superior de Agronomia, Lisboa, Portugal.

Spain (2012). National Inventory Report (2012 submission).

Teixeira, R., Domingos, T., Canaveira, P., Avelar, T., Basch, G., Belo, C.C., Calouro, F., Crespo, D., Ferreira, V.G., Martins, C. (2008b). Carbon sequestration in biodiverse sown grasslands. *Options méditerranéennes – Sustainable Mediterranean Grasslands and Their Multi-Functions*, A-79: 123-126.

Teixeira, R., Domingos, T., Costa, A.P.S.V., Oliveira, R., Farropas, L., Calouro, F., Barradas, A.M., Carneiro, J.P.B.G. (2008a). The dynamics of soil organic matter accumulation in Portuguese grasslands soils. *Options méditerranéennes – Sustainable Mediterranean Grasslands and Their Multi-Functions*, A-79: 41-44.

Teixeira, Ricardo et al., 2009. Soil organic carbon stocks in Portuguese cropland soils, IST/LQARS.

Teixeira, R. (2010). Sustainable Land Uses and Carbon Sequestration: the Case of Sown Biodiverse Permanent Pastures Rich in Legumes. Ph.D. Thesis in Environmental Engineering. Instituto Superior Técnico, Technical University of Lisbon, Lisbon.

Tomé, M., 2004. Modelo de crescimento e produção para a gestão do montado de sobro em Portugal. Relatório final do projecto POCTI/AGR/35172/99. Publicações GIMREF, RFP1/2005. Departamento de Engenharia Florestal, Instituto Superior de Agronomia, Lisboa, Portugal.

Tomé, M., Barreiro, S., Cortiçada, A., Paulo, J., Meyer, A. Ramos, T., Malico, P. (2007) Inventário Florestal 2005-2005. Áreas, volumes e biomassas dos povoamentos florestais. Resultados nacionais e por NUT's II e III. Publicações GIMREF PT 8

Tomé, M., Barreiro, S., Cortiçada, A., Paulo, J. A., Meyer, A. V., Ramos, T. & Malico, P., 2007. Inventário Florestal 2005-2006. Áreas, Volumes e Biomassas dos Povoamentos Florestais. Resultados Nacionais e por NUT's II e III. Publicações GIMREF, PT 8/2007, Centro de Estudos Florestais, Instituto Superior de Agronomia, Lisboa, Portugal.

Tomé, Margarida et al., 2009. Carbon Stock Changes in Portuguese Eucalyptus, ISA.

USEPA, 1979. AP-42, Compilation of Air Pollutant Emission Factors, Section 4.5, Final Section, "Asphalt Paving Operations", U.S. Environmental Protection Agency, Emissions Inventory Branch, Office of Air Quality Planning and Standards, Research Triangle Park, New York, USA.

USEPA, 1980. AP-42 Supplement 10 for Compilation of Air Pollutant Emission Factors, Third Edition. Research Triangle Park, North Carolina: U.S. Environmental Protection Agency, Office of Air Quality Planning and Standards, February, 1980.

USEPA, 1980b. AP-42, Compilation of Air Pollutant Emission Factors, Section 13.3, Final Section, "Explosive Detonation", U.S. Environmental Protection Agency, Emissions Inventory Branch, Office of Air Quality Planning and Standards, Research Triangle Park, New York, USA.



USEPA, 1981. AP-42, Compilation of Air Pollutant Emission Factors, Section 4.1, Final Section, "Dry Cleaning", U.S. Environmental Protection Agency, Emissions Inventory Branch, Office of Air Quality Planning and Standards, Research Triangle Park, New York, USA.

USEPA, 1981b. AP-42, Compilation of Air Pollutant Emission Factors, Section 4.9.1, Final Section, "General Graphic Arts", U.S. Environmental Protection Agency, Emissions Inventory Branch, Office of Air Quality Planning and Standards, Research Triangle Park, New York, USA.

USEPA, 1981c. AP-42, Compilation of Air Pollutant Emission Factors, Section 4.9.1, Final Section, "Publication Gravure Printing", U.S. Environmental Protection Agency, Emissions Inventory Branch, Office of Air Quality Planning and Standards, Research Triangle Park, New York, USA.

USEPA, 1983. AP-42, Compilation of Air Pollutant Emission Factors, Section 6.5, Final Section, "Phthalic Anhydride", U.S. Environmental Protection Agency, Emissions Inventory Branch, Office of Air Quality Planning and Standards, Research Triangle Park, New York, USA.

USEPA, 1983b. AP-42, Compilation of Air Pollutant Emission Factors, Section 6.5, Final Section, "Explosives", U.S. Environmental Protection Agency, Emissions Inventory Branch, Office of Air Quality Planning and Standards, Research Triangle Park, New York, USA.

USEPA, 1983c. AP-42, Compilation of Air Pollutant Emission Factors, Section 6.4, Final Section, "Paint and Varnishes", U.S. Environmental Protection Agency, Emissions Inventory Branch, Office of Air Quality Planning and Standards, Research Triangle Park, New York, USA.

USEPA, 1986. AP-42, Compilation of Air Pollutant Emission Factors, Section 11.15, Final Section, "Glass Manufacturing", U.S. Environmental Protection Agency, Emissions Inventory Branch, Office of Air Quality Planning and Standards, Research Triangle Park, New York, USA.

USEPA, 1986b. AP-42, Compilation of Air Pollutant Emission Factors, Section 12.3, Final Section, "Primary Copper Smelting", U.S. Environmental Protection Agency, Emissions Inventory Branch, Office of Air Quality Planning and Standards, Research Triangle Park, New York, USA.

USEPA, 1986c. AP-42, Compilation of Air Pollutant Emission Factors, Section 12.4, Final Section, "Ferroalloy Production", U.S. Environmental Protection Agency, Emissions Inventory Branch, Office of Air Quality Planning and Standards, Research Triangle Park, New York, USA.

USEPA, 1986d. AP-42, Compilation of Air Pollutant Emission Factors, Section 12.5, Final Section, "Iron and Steel Production", U.S. Environmental Protection Agency, Emissions Inventory Branch, Office of Air Quality Planning and Standards, Research Triangle Park, New York, USA.

USEPA, 1986e. AP-42, Compilation of Air Pollutant Emission Factors, Section 12.8, Final Section, "Secondary Aluminum Operations", U.S. Environmental Protection Agency, Emissions Inventory Branch, Office of Air Quality Planning and Standards, Research Triangle Park, New York, USA.

USEPA, 1990. AP-42, Compilation of Air Pollutant Emission Factors, Section 10.2, Final Section, "Chemical Wood Pulping", U.S. Environmental Protection Agency, Emissions Inventory Branch, Office of Air Quality Planning and Standards, Research Triangle Park, New York, USA.

USEPA, 1991. AP-42, Compilation of Air Pollutant Emission Factors, Section 6.6.3, Final Section, "Polystyrene", U.S. Environmental Protection Agency, Emissions Inventory Branch, Office of Air Quality Planning and Standards, Research Triangle Park, New York, USA.

USEPA, 1991b. AP-42, Compilation of Air Pollutant Emission Factors, Section 6.6.4, Final Section, "Polypropylene", U.S. Environmental Protection Agency, Emissions Inventory Branch, Office of Air Quality Planning and Standards, Research Triangle Park, New York, USA.



USEPA, 1991c. AP-42, Compilation of Air Pollutant Emission Factors, Section 6.6.1, Final Section, "Poly vinyl Chloride", U.S. Environmental Protection Agency, Emissions Inventory Branch, Office of Air Quality Planning and Standards, Research Triangle Park, New York, USA.

USEPA, 1991d. AP-42, Compilation of Air Pollutant Emission Factors, Section 6.7, Final Section, "Printing Ink", U.S. Environmental Protection Agency, Emissions Inventory Branch, Office of Air Quality Planning and Standards, Research Triangle Park, New York, USA.

USEPA, 1991e. AP-42, Compilation of Air Pollutant Emission Factors, Section 13.5, Final Section, "Industrial Flares", U.S. Environmental Protection Agency, Emissions Inventory Branch, Office of Air Quality Planning and Standards, Research Triangle Park, New York, USA.

USEPA, 1992. AP-42, Compilation of Air Pollutant Emission Factors, Section 2.5, Final Section, "Open Burning", U.S. Environmental Protection Agency, Emissions Inventory Branch, Office of Air Quality Planning and Standards, Research Triangle Park, New York, USA.

USEPA, 1993. AP-42, Compilation of Air Pollutant Emission Factors, Section 8.1, Final Section, "Synthetic Ammonia", U.S. Environmental Protection Agency, Emissions Inventory Branch, Office of Air Quality Planning and Standards, Research Triangle Park, New York, USA.

USEPA, 1993b. AP-42, Compilation of Air Pollutant Emission Factors, Section 8.10, Final Section, "Sulphuric Acid", U.S. Environmental Protection Agency, Emissions Inventory Branch, Office of Air Quality Planning and Standards, Research Triangle Park, New York, USA.

USEPA, 1993c. AP-42, Compilation of Air Pollutant Emission Factors, Section 8.2, Final Section, "Urea", U.S. Environmental Protection Agency, Emissions Inventory Branch, Office of Air Quality Planning and Standards, Research Triangle Park, New York, USA.

USEPA, 1993d. AP-42, Compilation of Air Pollutant Emission Factors, Section 8.3, Final Section, "Ammonium Nitrate", U.S. Environmental Protection Agency, Emissions Inventory Branch, Office of Air Quality Planning and Standards, Research Triangle Park, New York, USA.

USEPA, 1993e. AP-42, Compilation of Air Pollutant Emission Factors, Section 8.5.1, Final Section, "Normal Superphosphates", U.S. Environmental Protection Agency, Emissions Inventory Branch, Office of Air Quality Planning and Standards, Research Triangle Park, New York, USA.

USEPA, 1993f. AP-42, Compilation of Air Pollutant Emission Factors, Section 8.5.2, Final Section, "Triple Superphosphates", U.S. Environmental Protection Agency, Emissions Inventory Branch, Office of Air Quality Planning and Standards, Research Triangle Park, New York, USA.

USEPA, 1993g. AP-42, Compilation of Air Pollutant Emission Factors, Section 8.5.3, Final Section, "Ammonium Phosphate", U.S. Environmental Protection Agency, Emissions Inventory Branch, Office of Air Quality Planning and Standards, Research Triangle Park, New York, USA.

USEPA, 1993h. AP-42, Compilation of Air Pollutant Emission Factors, Section 8.13, Final Section, "Sulfur Recovery", U.S. Environmental Protection Agency, Emissions Inventory Branch, Office of Air Quality Planning and Standards, Research Triangle Park, New York, USA.

USEPA, 1995. AP-42, Compilation of Air Pollutant Emission Factors, Section 11.6, Final Section, "Portland Cement Manufacturing", U.S. Environmental Protection Agency, Emissions Inventory Branch, Office of Air Quality Planning and Standards, Research Triangle Park, New York, USA.

USEPA, 1995b. AP-42, Compilation of Air Pollutant Emission Factors, Section 12.13, Final Section, "Steel Foundries", U.S. Environmental Protection Agency, Emissions Inventory Branch, Office of Air Quality Planning and Standards, Research Triangle Park, New York, USA.



USEPA, 1995c. AP-42, Compilation of Air Pollutant Emission Factors, Section 5.1, Final Section, "Petroleum Refining", U.S. Environmental Protection Agency, Emissions Inventory Branch, Office of Air Quality Planning and Standards, Research Triangle Park, New York, USA.

USEPA, 1995d. AP-42, Compilation of Air Pollutant Emission Factors, Section 5.3, Final Section, "Natural Gas Processing", U.S. Environmental Protection Agency, Emissions Inventory Branch, Office of Air Quality Planning and Standards, Research Triangle Park, New York, USA.

USEPA, 1995e. AP-42, Compilation of Air Pollutant Emission Factors, Section 6.2, Final Section, "Adipic Acid", U.S. Environmental Protection Agency, Emissions Inventory Branch, Office of Air Quality Planning and Standards, Research Triangle Park, New York, USA.

USEPA, 1995f. AP-42, Compilation of Air Pollutant Emission Factors, Section 11.5, Final Section, "Refractory Manufacturing", U.S. Environmental Protection Agency, Emissions Inventory Branch, Office of Air Quality Planning and Standards, Research Triangle Park, New York, USA.

USEPA, 1995g. AP-42, Compilation of Air Pollutant Emission Factors, Section 9.11.1, Final Section, "Vegetable Oil Processing", U.S. Environmental Protection Agency, Emissions Inventory Branch, Office of Air Quality Planning and Standards, Research Triangle Park, New York, USA.

USEPA, 1995h. AP-42, Compilation of Air Pollutant Emission Factors, Section 9.5.2, Final Section, "Meat Smokehouses", U.S. Environmental Protection Agency, Emissions Inventory Branch, Office of Air Quality Planning and Standards, Research Triangle Park, New York, USA.

USEPA, 1995i. AP-42, Compilation of Air Pollutant Emission Factors, Section 9.12.2, Final Section, "Wines and Brandy", U.S. Environmental Protection Agency, Emissions Inventory Branch, Office of Air Quality Planning and Standards, Research Triangle Park, New York, USA.

USEPA, 1995j. AP-42, Compilation of Air Pollutant Emission Factors, Section 9.13.1, Final Section, "Fish Processing", U.S. Environmental Protection Agency, Emissions Inventory Branch, Office of Air Quality Planning and Standards, Research Triangle Park, New York, USA.

USEPA, 1995k. AP-42, Compilation of Air Pollutant Emission Factors, Section 9.13.2, Final Section, "Coffee Roasting", U.S. Environmental Protection Agency, Emissions Inventory Branch, Office of Air Quality Planning and Standards, Research Triangle Park, New York, USA.

USEPA, 1996. AP-42, Compilation of Air Pollutant Emission Factors, Section 1.2, Final Section, "Anthracite Coal Combustion", U.S. Environmental Protection Agency, Emissions Inventory Branch, Office of Air Quality Planning and Standards, Research Triangle Park, New York, USA.

USEPA, 1996b. AP-42, Compilation of Air Pollutant Emission Factors, Section 8.4, Final Section, "Ammonium Sulphate", U.S. Environmental Protection Agency, Emissions Inventory Branch, Office of Air Quality Planning and Standards, Research Triangle Park, New York, USA.

USEPA, 1996b. AP-42, Compilation of Air Pollutant Emission Factors, Section 1.5, Final Section, "Liquified Petroleum Gas Combustion", U.S. Environmental Protection Agency, Emissions Inventory Branch, Office of Air Quality Planning and Standards, Research Triangle Park, New York, USA.

USEPA, 1996c. AP-42, Compilation of Air Pollutant Emission Factors, Section 11.6, Final Section, "Ceramic Products Manufacturing", U.S. Environmental Protection Agency, Emissions Inventory Branch, Office of Air Quality Planning and Standards, Research Triangle Park, New York, USA.

USEPA, 1996d. AP-42, Compilation of Air Pollutant Emission Factors, Section 8.4, Final Section, "Ammonium Sulfate", U.S. Environmental Protection Agency, Emissions Inventory Branch, Office of Air Quality Planning and Standards, Research Triangle Park, New York, USA.



USEPA, 1996e. AP-42, Compilation of Air Pollutant Emission Factors, Section 9.12.1, Final Section, "Malt Beverages", U.S. Environmental Protection Agency, Emissions Inventory Branch, Office of Air Quality Planning and Standards, Research Triangle Park, New York, USA.

USEPA, 1997. AP-42, Compilation of Air Pollutant Emission Factors, Section 11.3, Final Section, "Bricks and Related Clay Products", U.S. Environmental Protection Agency, Emissions Inventory Branch, Office of Air Quality Planning and Standards, Research Triangle Park, New York, USA.

USEPA, 1997b. AP-42, Compilation of Air Pollutant Emission Factors, Section 7.1, Final Section, "Organic Liquids Storage Tanks", U.S. Environmental Protection Agency, Emissions Inventory Branch, Office of Air Quality Planning and Standards, Research Triangle Park, New York, USA.

USEPA, 1997c. AP-42, Compilation of Air Pollutant Emission Factors, Section 9.5.1, Final Section, "Meat Packing Houses", U.S. Environmental Protection Agency, Emissions Inventory Branch, Office of Air Quality Planning and Standards, Research Triangle Park, New York, USA.

USEPA, 1997d. AP-42, Compilation of Air Pollutant Emission Factors, Section 9.9.6, Final Section, "Bread Baking", U.S. Environmental Protection Agency, Emissions Inventory Branch, Office of Air Quality Planning and Standards, Research Triangle Park, New York, USA.

USEPA, 1997e. AP-42, Compilation of Air Pollutant Emission Factors, Section 9.12.3, Final Section, "Distilled Spirits", U.S. Environmental Protection Agency, Emissions Inventory Branch, Office of Air Quality Planning and Standards, Research Triangle Park, New York, USA.

USEPA, 1998. AP-42, Compilation of Air Pollutant Emission Factors, Section 1.1, Final Section, "Bituminous And Subbituminous Coal Combustion", U.S. Environmental Protection Agency, Emissions Inventory Branch, Office of Air Quality Planning and Standards, Research Triangle Park, New York, USA.

USEPA, 1998b. AP-42, Compilation of Air Pollutant Emission Factors, Section 1.3, Final Section, "Fuel Oil Combustion", U.S. Environmental Protection Agency, Emissions Inventory Branch, Office of Air Quality Planning and Standards, Research Triangle Park, New York, USA.

USEPA, 1998c. AP-42, Compilation of Air Pollutant Emission Factors, Section 1.4, Final Section, "Natural Gas Combustion", U.S. Environmental Protection Agency, Emissions Inventory Branch, Office of Air Quality Planning and Standards, Research Triangle Park, New York, USA.

USEPA, 1998d. AP-42, Compilation of Air Pollutant Emission Factors, Section 11.17, Final Section, "Lime Manufacturing", U.S. Environmental Protection Agency, Emissions Inventory Branch, Office of Air Quality Planning and Standards, Research Triangle Park, New York, USA.

USEPA, 1998e. AP-42, Compilation of Air Pollutant Emission Factors, Section 8.8, Final Section, "Nitric Acid", U.S. Environmental Protection Agency, Emissions Inventory Branch, Office of Air Quality Planning and Standards, Research Triangle Park, New York, USA.

USEPA, 1998f. AP-42, Compilation of Air Pollutant Emission Factors, Section 9.9.1, Final Section, "Grain Elevators and Processes", U.S. Environmental Protection Agency, Emissions Inventory Branch, Office of Air Quality Planning and Standards, Research Triangle Park, New York, USA.

USEPA, 1999. USER'S GUIDE to TANKS. Storage Tank Emissions Calculation Software. Version 4.0

USEPA, 2000. AP-42, Compilation of Air Pollutant Emission Factors, Section 11.1, Final Section, "Hot Mix Asphalt Plants", U.S. Environmental Protection Agency, Emissions Inventory Branch, Office of Air Quality Planning and Standards, Research Triangle Park, New York, USA.



USEPA, 2000d. AP-42, Compilation of Air Pollutant Emission Factors, Section 12.2, Final Section, "Coke Production", U.S. Environmental Protection Agency, Emissions Inventory Branch, Office of Air Quality Planning and Standards, Research Triangle Park, New York, USA.

USEPA, 2001. EIIP, Volume III, Chapter 11, Revised Final, "Gasoline Marketing (Stage I and Stage II)", U.S. Environmental Protection Agency, Emissions Inventory Branch, Eastern Research Group, USA.

USEPA, 2001b. EIIP, Volume III, Chapter 12, Revised Final, "Marine Vessel Loading, Ballasting, and Transit", U.S. Environmental Protection Agency, Emissions Inventory Branch, Eastern Research Group, USA.

USEPA, 2001c. EIIP, Volume III, Chapter 17, Revised Final, "Asphalt Paving", U.S. Environmental Protection Agency, Emissions Inventory Branch, Eastern Research Group, USA.

USEPA, 2003. AP-42, Compilation of Air Pollutant Emission Factors, Section 1.6, Final Section, "Wood Residue Combustion in Boilers", U.S. Environmental Protection Agency, Emissions Inventory Branch, Office of Air Quality Planning and Standards, Research Triangle Park, New York, USA.

USEPA, 2003b. AP-42, Compilation of Air Pollutant Emission Factors, Section 9.9.1, Final Section, "Grain Elevators and Processes", U.S. Environmental Protection Agency, Emissions Inventory Branch, Office of Air Quality Planning and Standards, Research Triangle Park, New York, USA.

USEPA, 2004. AP-42, Compilation of Air Pollutant Emission Factors, Section 11.1, Final Section, "Hot Mix Asphalt Plants", U.S. Environmental Protection Agency, Emissions Inventory Branch, Office of Air Quality Planning and Standards, Research Triangle Park, New York, USA.

Valente A.J.R., Nunes, T.V. And C.A. Pio - 1996, Emission of Volatile Organic Compounds by the Portuguese coniferous forests in Portugal (in Portuguese), 5ª Conferência Nacional sobre a Qualidade do Ambiente, 771-782, University of Algarve, Portugal.

Vanmechelen, L., R. Groenemans & E. van Ranst (1997) - Forest soil conditions in Europe. Results of a large-scale soil survey, Forest Soil Co-ordinating Centre / UN-ECE & EC, Geneva & Brussels.

Veldt, C - 1988, Inventorying natural VOC emissions for the CORINAIR project. In Corinair Default Emission Factor handbook, Technical Annexes Volume 2, European Commission EUR 12586/2, 101-128

Veldt, C. - 1991, The use of biogenic VOC measurements in emissions inventories, Apeldoorn, The Netherlands, MT-TNO Report 91-323

Veldt, C. -1989, Leaf biomass data for the estimation of biogenic VOC emissions, Apeldoorn, The Netherlands, MT-TNO Report 89-306

Vivancos, A.D. 1997. Tratado de Fertilización. Ediciones Mundi-Prensa. Madrid

<http://www.igeo.pt/produtos/CEGIG/COS.htm> – consulted in March 2022

http://www.iea.org/stats/balancetable.asp?COUNTRY_CODE=PT – consulted in March 2022

<http://www.ine.pt/> - consulted in January 2022

faostat.fao.org/ - consulted in November 2021



Annex A: Energy Balance

Updated: March 2023

Table A-1: Energy Balance Sheet for 2021

BALANÇO ENERGÉTICO tep	Hulha e Antracite	Coque de Carvão	Total de Carvão	Petróleo Bruto	Refugos e Produtos Intermediários	GPL	Gasolinas	Petróleos	Jets	Gasóleo	Fuelóleo	Nafta	Coque de Petróleo	Total de Petróleo Energético	Lubrificantes	Asfaltos	Parafinas	Solventes	Outros	Total de Petróleo Não Energético	Total de Petróleo	Gás Natural	
2021 provisório	1	2	3 = 1 + 2	4	5	6	7	8	9	10	11	12	13	14 = 4 a 13	15	16	17	18	19	20 = 15 a 19	21 = 14 + 20	22	
IMPORTAÇÕES	01	2 251	6 789	9 040	9 628 181	1 425 718	819 261	213 366	229	152 559	1 527 505	150 259	201 747	214 314	14 333 139	40 945	227 350	3 679	4 653	5 178	281 805	14 614 944	4 975 907
PRODUÇÃO DOMÉSTICA	02																						
VARIACÃO DE "STOCKS"	03	- 185 514	- 1 194	- 186 708	- 136 421	- 33 085	- 16 831	- 38 628	117	43 657	- 95 067	81 835	- 3 329	- 20 270	- 218 022	- 340	- 1 606	- 857	- 735	13 595	10 057	- 207 965	2 205
SAÍDAS	04	1	169	170	153 526	39 471	1 489 874		662 149	1 546 149	2 049 870	235 276		6 176 315	48 329	41 244	2 097	3 937	95 158	190 765	6 367 080		
Exportações	04.01	1	169	170	153 526	39 471	1 489 874		662 149	1 546 149	2 049 870	235 276		6 176 315	48 329	41 244	2 097	3 937	95 158	190 765	6 367 080		
Transportes Marítimos Internacionais	04.02								2 526	1 402 547	1 532 593	235 276		4 855 813	47 738	41 244	2 097	3 937	95 158	190 174	5 045 987		
Aviação Internacional	04.03								659 623	143 602	517 277			660 879	591					591	661 470		
														659 623							659 623		
CONSUMO DE ENERGIA PRIMÁRIA	05	187 764	7 814	195 578	9 764 602	1 305 277	796 621	-1 237 880	112	- 553 247	-4 750 607	-2 165 175	- 579 438		8 374 846	- 7 044	187 712	2 439	1 451	- 103 575	80 983	8 455 829	4 973 702
PARA NOVAS FORMAS DE ENERGIA	06	185 459		185 459	9 758 942	909 096	- 42 744	-2 262 898	- 159	- 680 260	-4 750 607	-2 165 175	- 579 438		186 757	- 53 859	- 61 770	- 2 483	- 4 530	- 114 996	- 237 638	- 50 881	3 015 884
Briquetes	06.01																						
Coque	06.02																						
Produtos de Petróleo	06.03				9 758 942	1 032 757	- 130 593	-2 262 898	- 159	- 680 260	-4 766 960	-2 399 152	- 715 505		- 163 828	- 53 859	- 61 770	- 2 483	- 4 530	- 114 996	- 237 638	- 401 466	165 682
Hidrogénio	06.04																						
Petroquímica	06.05					- 158 266	87 849								65 650							65 650	
Electricidade	06.06	185 459		185 459						16 332	142 661			158 993							158 993	1 782 937	
Cogeração	06.07					34 605				21	91 316			125 942							125 942	1 067 265	
Produção de Electricidade	06.07.01									21	41 565			41 586							41 586	330 413	
Refinação de Petróleo	06.07.02					34 605								34 605							34 605		
Gás de Cidade	06.07.03																						
Agricultura	06.07.04																						7 825
Alimentação, bebidas e tabaco	06.07.05										7 993			7 993							7 993	63 591	
Têxteis	06.07.06																					115 560	
Papel e Artigos de Papel	06.07.07										15 404			15 404							15 404	280 835	
Químicas e Plásticos	06.07.08										26 354			26 354							26 354	142 043	
Cerâmicas	06.07.09																					20 875	
Vidro e Artigos de Vidro	06.07.10																						
Cimento e Cal	06.07.11																					2 029	
Metalgúrgicas	06.07.12																						
Siderurgia	06.07.13																						
Vestuário, Calçado e Curtumes	06.07.14																					6 300	
Madeira e Artigos de Madeira	06.07.15																						
Borracha	06.07.16																					7 399	
Metálo-eleto-mecânicas	06.07.17																					1 799	
Outras Indústrias Transformadoras	06.07.18																					2 342	
Indústrias Extrativas	06.07.19																					17 478	
Serviços	06.07.20																					68 776	



National Inventory Report - Portugal



BALANÇO ENERGÉTICO tep		Hulha e Antracite	Coque de Carvão	Total de Carvão	Petróleo Bruto	Refugos e Produtos Intermediários	GPL	Gasolinas	Petróleos	Jets	Gasóleo	Fuelóleo	Nata	Coque de Petróleo	Total de Petróleo Energético	Lubrificantes	Asfaltos	Parafinas	Solventes	Outros	Total de Petróleo Não Energético	Total de Petróleo	Gás Natural
2021 provisório		1	2	3 = 1 + 2	4	5	6	7	8	9	10	11	12	13	14 = 4 a 13	15	16	17	18	19	20 = 15 a 19	21 = 14 + 20	22
CONSUMO DO SECTOR ENERGÉTICO	07				5 660	396 181	220		85				98 443	457	501 046		458	110	82		650	501 696	98 059
Consumo Próprio da Refinação	07.01					359 983	220						96 672		456 875							456 875	90 791
Perdas da Refinação	07.02				5 660	36 198			85				1 771	457	44 171		458	110	82		650	44 821	
Coquerie e outras não especificadas	07.03																						
Centrais Elétricas	07.04																						
Bombagem Hidroelétrica	07.05																						
Extração de Carvão, Petróleo e GN	07.06																						
Perdas de Transporte e Distribuição	07.07																						7 268
CONSUMO COMO MATÉRIA PRIMA	08						331 651								880 432							880 432	56 128
DISPONÍVEL PARA CONSUMO FINAL	09	2 305	7 814	10 119			507 494	1 025 018	186	127 013	4 827 030	85 286		234 584	6 806 611	46 815	249 024	4 812	5 899	11 421	317 971	7 124 582	1 803 631
ACERTOS		54	98	152			14 753	2 718	- 172	- 16 769	- 24 890	- 17 769		2 391	- 39 738	- 401	- 4 160	- 464	130	- 25	- 4 921	- 44 659	32 276
CONSUMO FINAL	10	2 251	7 716	9 967			492 741	1 022 300	358	143 782	4 851 920	103 055		232 193	6 846 349	47 216	253 184	5 276	5 769	11 446	322 892	7 169 241	1 771 355
AGRICULTURA E PISCAS	10.01						4 565	485	219		401 178	2 556			409 003	384					384	409 387	7 539
Agricultura	10.01.01						4 565	345	219		312 691	64			317 884	171					171	318 055	7 530
Pescas	10.01.02							140			88 487	2 492			91 119	213					213	91 332	9
INDÚSTRIAS EXTRATIVAS	10.02						967				29 755	1 569			32 291	677	9				686	32 977	2 947
INDÚSTRIAS TRANSFORMADORAS	10.03	2 251	7 716	9 967			46 860	1 376	21		72 684	34 364		232 193	387 498	12 738	5 564	5 276	5 651	11 446	40 675	428 173	1 201 791
Alimentação, bebidas e tabaco	10.03.01						15 833				9 382	17 181			42 396	194					194	42 590	171 353
Têxteis	10.03.02						1 838				182	1 818			3 838	744					744	4 582	152 821
Papel e Artigos de Papel	10.03.03						776		3		3 202	12 940			16 921	649		2 750	3 745	7 144	24 065	152 771	
Químicas e Plásticos	10.03.04						2 497		1		1 638	837			4 973	4 645	5 564	4 040	2 815	7 701	24 765	29 738	95 429
Cerâmicas	10.03.05						2 870		1		989			7 552	11 412	77					77	11 489	211 318
Vidro e Artigos de Vidro	10.03.06						97				141				238	174					174	412	186 593
Cimento e Cal	10.03.07						426		15		15 980			224 641	241 062	298					298	241 360	49 929
Metalúrgicas	10.03.08	1	5 612	5 613			1 266				465			1 731	483				3		486	2 217	26 263
Siderurgia	10.03.09	2 107	1 954	4 061			8				1 458			1 466	372				11		383	1 849	49 530
Vestuário, Calçado e Curtumes	10.03.10						2 120				268	262			2 650	22					22	2 672	12 950
Madeira e Artigos de Madeira	10.03.11						1 132				4 465	26			5 623	310					984	6 607	9 954
Borracha	10.03.12						751				22				773	2 286	674	562			2 848	3 621	8 728
Metalo-eleto-mecânicas	10.03.13	2	93	95			14 743	1 376	1		8 359				24 479	2 267					2 339	26 818	59 771
Outras Indústrias Transformadoras	10.03.14	141	57	198			2 503				26 133	1 300			29 936	217					217	30 153	14 381
CONSTRUÇÃO E OBRAS PÚBLICAS	10.04						8 203		1		79 291	13 081			100 576	1 060	247 611		112		248 783	349 359	16 313
TRANSPORTES	10.05						34 663	1 020 324	37	119 429	4 189 704	42 984			5 407 141	32 136					32 136	5 439 277	23 803
Aviação Nacional	10.05.01							1 243		119 429					120 672	49					49	120 721	
Transportes Marítimos Nacionais	10.05.02										30 441	42 984			73 425	375					375	73 800	
Caminho de Ferro	10.05.03										8 712				8 712							8 712	
Rodoviários	10.05.04						34 663	1 019 081	37		4 150 551				5 204 332	31 712					31 712	5 236 044	23 803
SETOR DOMÉSTICO	10.06						339 156		72		49 689				388 917							388 917	287 759
SERVIÇOS	10.07						58 327	115	8	24 353	29 619	8 501			120 923	221			6		228	121 151	231 203



National Inventory Report - Portugal



BALANÇO ENERGÉTICO tep 2021 provisório		Gases Incond. de Petroquímica 23	Hidrogénio 24	Gases e Outros Derivados 25 = 23 + 24	Hidro- eletricidade 26	Eólica 27	Foto- voltaica 28	Geo- térmica 29	Termo- eletricidade 30	Total de Eletricidade 31	Calor 32	Resíduos não Renováveis 33	Solar Térmico 34	Lenhas e Resíduos Vegetais 35	Resíduos Sólidos Urbanos 36	Licores Sulfúricos 37	Outros Renováveis 38	Biogás 39	Biocombustiv eis 40	Bombas de Calor 41	Renováveis Sem Eletricidade 42 = 34 a 41	TOTAL GERAL 43=3+21+22+25 +31+32+33+42
IMPORTAÇÕES	01									820 820		24 908		60 358			22 089		145 138		227 585	20 673 204
PRODUÇÃO DOMÉSTICA	02				1 157 098	1 136 543	192 396	15 355		2 501 392		173 933	105 480	1 858 993	132 208	1 010 303	20 324	87 311	285 888	706 102	4 206 609	6 881 934
VARIACÃO DE "STOCKS"	03																		- 1 878		- 1 878	- 394 346
SÁIDAS	04									412 063				286 580					66 130		352 710	7 132 023
Exportações	04.01									412 063				286 580					66 130		352 710	5 810 930
Transportes Marítimos Internacionais	04.02																					661 470
Aviação Internacional	04.03																					659 623
CONSUMO DE ENERGIA PRIMÁRIA	05				1 157 098	1 136 543	192 396	15 355		2 910 149		198 841	105 480	1 632 771	132 208	1 010 303	42 413	87 311	366 774	706 102	4 083 362	20 817 461
PARA NOVAS FORMAS DE ENERGIA	06				1 157 098	1 136 543	192 396	15 355	-1 882 127	-1 882 127	-1 346 813	110 048		644 294	132 208	1 010 303		80 075	365 714		2 232 594	2 264 164
Briquetes	06.01																					105 217
Coque	06.02																					24 713
Produtos de Petróleo	06.03		140 969	140 969															365 714		365 714	- 1 495
Hidrogénio	06.04		- 140 969	- 140 969																		1 540 857
Petroquímica	06.05	- 67 145		- 67 145																		594 875
Eletricidade	06.06				1 157 098	1 136 543	192 396	15 355	-1 309 953	-1 309 953	-1 346 813	100 553		415 736	132 208	1 010 303		74 924			622 868	1 540 857
Cogeração	06.07	67 145		67 145					- 572 174	- 572 174	- 1 346 813	9 495		228 558				5 151			1 244 012	594 875
Produção de Eletricidade	06.07.01								- 16 634	- 16 634	- 931											24 021
Refinação de Petróleo	06.07.02								- 102 526	- 102 526	- 157 942											104 550
Gás de Cidade	06.07.03																					
Agricultura	06.07.04								- 3 314	- 3 314	- 2 935							440			440	2 016
Alimentação, bebidas e tabaco	06.07.05								- 19 118	- 19 118	- 39 117											13 349
Têxteis	06.07.06								- 46 582	- 46 582	- 38 766											30 212
Papel e Artigos de Papel	06.07.07								- 273 222	- 273 222	- 914 230			177 902		1 010 303		97			1 188 302	297 089
Químicas e Plásticos	06.07.08	67 145		67 145					- 55 955	- 55 955	- 118 036	7 953										69 504
Cerâmicas	06.07.09								- 6 913	- 6 913	- 9 811											4 151
Vidro e Artigos de Vidro	06.07.10																					
Cimento e Cal	06.07.11								- 860	- 860	- 640											529
Metalgúrgicas	06.07.12																					
Siderurgia	06.07.13																					
Vestuário, Calçado e Curtumes	06.07.14								- 2 617	- 2 617	- 1 684											1 999
Madeira e Artigos de Madeira	06.07.15								- 6 950	- 6 950	- 21 230			50 656							50 656	22 476
Borracha	06.07.16								- 2 541	- 2 541	- 4 188	1 542										2 212
Metálo-eleto-mecânicas	06.07.17								- 768	- 768	- 624											407
Outras Indústrias Transformadoras	06.07.18								- 1 691	- 1 691	- 1 033							2 093			2 093	1 711
Indústrias Extrativas	06.07.19								- 5 054	- 5 054	- 9 770											2 654
Serviços	06.07.20								- 27 426	- 27 426	- 25 876							2 521			2 521	17 995



National Inventory Report - Portugal



BALANÇO ENERGÉTICO tep	Gases Incond. de Petroquímica	Hidrogénio	Gases e Outros Derivados	Hidro- eletricidade	Eólica	Fol- vollaica	Geo- térmica	Termo- eletricidade	Total de Eletricidade	Calor	Resíduos não Renováveis	Solar Térmico	Lenhas e Resíduos Vegetais	Resíduos Sólidos Urbanos	Licores Sulfúricos	Outros Renováveis	Biogás	Biocombustiv- eis	Bombas de Calor	Renováveis Sem Eletricidade	TOTAL GERAL	
																						23
2021 provisório																						
CONSUMO DO SECTOR ENERGÉTICO	07								723 149	157 942												1 480 846
Consumo Próprio da Refinação	07.01								49 926	157 942												755 534
Perdas da Refinação	07.02																					44 821
Coquerie e outras não especificadas	07.03								3													3
Centrais Elétricas	07.04								71 475													71 475
Bombagem Hidroelétrica	07.05								171 037													171 037
Extração de Carvão, Petróleo e GN	07.06																					
Perdas de Transporte e Distribuição	07.07								430 708													437 976
CONSUMO COMO MATÉRIA PRIMA	08																					936 560
DISPONÍVEL PARA CONSUMO FINAL	09								4 069 127	1 188 871	88 793	105 480	988 477			42 413	7 236	1 060	706 102	1 850 768	16 135 891	
ACERTOS									422									1			1	- 11 808
CONSUMO FINAL	10								4 068 705	1 188 871	88 793	105 480	988 477			42 413	7 236	1 059	706 102	1 850 767	16 147 699	
AGRICULTURA E PISCAS	10.01								95 829	2 935			1 824								1 824	517 514
Agricultura	10.01.01								89 668	2 935			1 824								1 824	420 012
Pescas	10.01.02								6 161													97 502
INDÚSTRIAS EXTRATIVAS	10.02								43 561	9 770												89 255
INDÚSTRIAS TRANSFORMADORAS	10.03								1 367 639	1 150 474	88 793		182 770			41 059	7 236	280			231 345	4 478 182
Alimentação, bebidas e tabaco	10.03.01								173 028	39 117			29 790				2 252				32 042	458 130
Têxteis	10.03.02								73 237	38 766			8 081								8 081	277 487
Papel e Artigos de Papel	10.03.03								268 290	914 230			38 066								43 050	1 402 406
Químicas e Plásticos	10.03.04								219 375	118 036	180		4 644			4 984					4 924	467 682
Cerâmicas	10.03.05								39 216	9 811			20 172					280			20 172	292 006
Vidro e Artigos de Vidro	10.03.06								48 152													235 157
Cimento e Cal	10.03.07								58 719	640	88 613		19 221			41 059					60 280	499 541
Metalúrgicas	10.03.08								24 891				3								3	58 987
Siderurgia	10.03.09								117 136													172 576
Vestuário, Calçado e Curtumes	10.03.10								26 878	1 684			1 767								1 767	45 951
Madeira e Artigos de Madeira	10.03.11								83 846	21 230			55 671								55 671	177 308
Borracha	10.03.12								21 967	4 188												38 504
Metalo-eleto-mecânicas	10.03.13								152 268	624			155								155	239 731
Outras Indústrias Transformadoras	10.03.14								60 636	2 148			5 200								5 200	112 716
CONSTRUÇÃO E OBRAS PÚBLICAS	10.04								38 476													404 148
TRANSPORTES	10.05								40 114									779			779	5 503 973
Aviação Nacional	10.05.01																					120 721
Transportes Marítimos Nacionais	10.05.02																					73 800
Caminho de Ferro	10.05.03								38 606													47 318
Rodoviários	10.05.04								1 508									779			779	5 262 134
SETOR DOMÉSTICO	10.06								1 219 283			59 639	781 218							267 968	1 108 825	3 004 784
SERVIÇOS	10.07								1 263 803	25 692		45 841	22 665			1 354			438 134		507 994	2 149 843



Annex B: Energy (CRF 1.A.3, 1.A.4 and 1.A.5)

Updated: March 2023

Transport (CRF 1.A.3)

Table B-1: Activity data for CRF 1.A.3.a: Fuel consumption from Aviation sector (t)

Fuel Sales	NAPFUE	1990	1991	1992	1993	1994	1995	1996	1997	1998	1999	2000	2001	2002	2003	2004	2005	
Aviation Gasoline	L	209	1 893	1 751	1 560	1 212	1 435	1 914	1 540	1 876	1 925	1 964	2 353	2 304	2 334	1 985	1 847	2 192
Jet Fuel	L	207	554 471	564 264	596 977	565 406	572 457	599 465	595 172	613 723	654 021	720 960	752 932	741 541	715 095	770 040	835 208	865 857

Fuel Sales	NAPFUE	2006	2007	2008	2009	2010	2011	2012	2013	2014	2015	2016	2017	2018	2019	2020	2021	
Aviation Gasoline	L	209	2 179	2 086	2 280	2 869	2 258	1 268	1 168	1 333	1 257	1 256	1 211	804	1 101	1 072	1 183	
Jet Fuel	L	207	907 189	949 650	969 349	907 530	985 343	1 006 836	1 015 897	1 027 228	1 086 001	1 139 567	1 239 311	1 409 602	1 501 383	1 580 683	592 926	758 571



Table B-2: Aircraft type and representative aircraft for LTO and cruise emission factors

Code	Aircraft Name	Fuel Type	Description	Representative	
				LTO	Cruise
100	Fokker 100	LJeK	L2J	100	100
146	BAe 146 all pax models	LJeK	L4J	146	146
310	Airbus A310 all pax models	LJeK	L2J	310	310
319	Airbus A319	LJeK	L2J	319	320
320	Airbus A320-100/200	LJeK	L2J	321	320
321	Airbus A321-100/200	LJeK	L2J	321	320
330	Airbus A330 all models	LJeK	L2J	330	330
332	Airbus A330-200	LJeK	L2J	330	330
333	Airbus A330-300	LJeK	L2J	330	330
340	Airbus A340 all models	LJeK	L4J	342	340
342	Airbus A340-200	LJeK	L4J	342	340
343	Airbus A340-300	LJeK	L4J	343	340
346	Airbus A340-600	LJeK	L4J	346	340
707	Boeing 707/720 all pax models	LJeK	L4J	707	340
717	Boeing 717	LJeK	L2J	717	NA
727	Boeing 727 all pax models	LJeK	L3J	727	727
731	Boeing 737-100 pax	LJeK	L2J	731	731
735	Boeing 737-500 pax	LJeK	L2J	735	734
736	Boeing 737-600 pax	LJeK	L2J	736	734
737	Boeing 737 all pax models	LJeK	L2J	731	731
739	Boeing 737-900 pax	LJeK	L2J	739	734
741	Boeing 747-100 pax	LJeK	L4J	741	741
747	Boeing 747 all pax models	LJeK	L4J	747	741
753	Boeing 757-300 pax	LJeK	L2J	752	757
757	Boeing 757 all pax models	LJeK	L2J	752	757
764	Boeing 767-400 pax	LJeK	L2J	764	767
767	Boeing 767 all pax models	LJeK	L2J	767	767
772	Boeing 777-200 pax	LJeK	L2J	772	777
773	Boeing 777-300 pax	LJeK	L2J	773	777
777	Boeing 777 all pax models	LJeK	L2J	772	777
14F	BAe 146 Freighter (-100/200/300QT & QC)	LJeK	L4J	146	146
31F	Airbus A310 Freighter	LJeK	L2J	310	310
31X	Airbus A310-200 Freighter	LJeK	L2J	312	310
32S	Airbus A318/319/320/321	LJeK	L2J	320	320
70F	Boeing 707 Freighter	LJeK	L4J	70F	340
70M	Boeing 707 Combi	LJeK	L4J	707	340
72F	Boeing 727 Freighter (-100/200)	LJeK	L3J	72F	727
72M	Boeing 727 Combi	LJeK	L3J	727	727
72S	Boeing 727-200 Advanced pax	LJeK	L3J	722	727
72X	Boeing 727-100 Freighter	LJeK	L3J	721	727
73F	Boeing 737 all Freighter models	LJeK	L2J	731	731
73H	Boeing 737-800 (winglets) pax	LJeK	L2J	73H	734
73M	Boeing 737-200 Combi	LJeK	L2J	732	731
73W	Boeing 737-700 (winglets) pax	LJeK	L2J	73W	734
73Y	Boeing 737-300 Freighter	LJeK	L2J	733	731
74C	Boeing 747-200 Combi	LJeK	L4J	742	741
74F	Boeing 747 all Freighter models	LJeK	L4J	74F	741
74J	Boeing 747-400 (Domestic) pax	LJeK	L4J	744	74J
74M	Boeing 747 all Combi models	LJeK	L4J	747	741
74U	Boeing 747-300 / 747-200 SUD Freighter	LJeK	L4J	743	741
75F	Boeing 757 Freighter	LJeK	L2J	75F	757
75M	Boeing 757 Mixed Configuration	LJeK	L2J	752	757
76F	Boeing 767 all Freighter models	LJeK	L2J	767	767
76X	Boeing 767-200 Freighter	LJeK	L2J	762	767
76Y	Boeing 767-300 Freighter	LJeK	L2J	763	767
A109	Agusta A-109	LJeK	H2T	S61	NA
A26	Antonov AN-26	LJeK	L2T	A26	AN6
A32	Antonov AN-32	LJeK	L2T	A32	NA
A4F	Antonov AN-124 Ruslan	LJeK	L4J	A4F	340
A660	Ayres Turbo Thrush (S-2R-T660)	LJeK	L1T	C208	C208
AA5	Gulfstream American AA-5 Traveler	LAvG	L1P	AA5	DHO
AB3	Airbus Industrie A300 pax	LJeK	L2J	AB3	310
AB4	Airbus Industrie A300B2/B4/C4 pax	LJeK	L2J	AB4	310
AB6	Airbus Industrie A300-600 pax	LJeK	L2J	AB6	310
ABB	Airbus Industrie A300-600ST Beluga Freighter	LJeK	L2J	AB6	310
ABF	Airbus Industrie A300 Freighter	LJeK	L2J	AB3	310
AC11	Rockwell Commander	LAvG	L1P	C150	DHO



National Inventory Report - Portugal



Code	Aircraft Name	Fuel Type	Description	Representative	
				LTO	Cruise
ACD	Gulfstream/Rockwell (Aero) Commander/Turbo Commander	L JeK	L2T	ACD	NA
ACT	Gulfstream/Rockwell (Aero) Turbo Commander	L JeK	L2T	ACT	NA
AEST	Aerostar 600	L AvG	L2P	AEST	DHO
AJET	Dassault Alpha Jet	L JeK	L2J	FA10	S20
ALO3	Aerospatiale Alouette 3	L JeK	H1T	ALO3	NA
AN4	Antonov AN-24	L JeK	L2T	AN4	NA
AN6	Antonov AN-26 / AN-30 / AN-32	L JeK	L2T	A26	AN6
AN7	Antonov AN-72 / AN-74	L JeK	L2J	AN7	F27
ANF	Antonov AN-12	L JeK	L4T	ANF	NA
APH	Eurocopter (Aerospatiale) SA330 Puma / AS332 Super Puma	L JeK	H2T	S61	NA
ARJ	Avro RJ70 / RJ85 / RJ100 Avroliner	L JeK	L4J	ARJ	146
AS32	Aerospatiale Super Puma	L JeK	H2T	S61	NA
AS50	Aerospatiale Fennec (AS-550)	L JeK	H1T	S61	NA
AS65	Aerospatiale Dolphin (AS-366)	L JeK	H2T	AS65	NA
ASTR	IAI Gulfstream G100	L JeK	L2J	WWP	S20
AT3	AIDC AT-3 Tzu-Chung	L JeK	L2J	AT3	NA
AT43	Aerospatiale/Alenia ATR 42-300 / 320	L JeK	L2T	ATR	AT42
AT5	Aerospatiale/Alenia ATR 42-500	L JeK	L2T	ATR	AT42
AT5T	Air Tractor AT-502	L JeK	L1T	C208	C208
AT7	Aerospatiale/Alenia ATR 72	L JeK	L2T	ATR	AT7
AT8T	Air Tractor AT-802 Fire Boss	L JeK	L1T	C208	NA
ATP	British Aerospace ATP	L JeK	L2T	ATR	AT42
ATR	Aerospatiale/Alenia ATR 42/ ATR 72	L JeK	L2T	ATR	AT42
B06	Agusta AB-206 LongRanger	L JeK	H1T	S61	NA
B11	British Aerospace (BAC) One Eleven / RomBAC One Eleven	L JeK	L2J	B11	B11
B12	British Aerospace (BAC) One Eleven 200	L JeK	L2J	B12	B11
B200	Beech 200 Super King Air	L JeK	L2T	BE20	BE20
B350	Beech Super King Air 350	L JeK	L2T	BE30	B350
B36T	Allison 36 Turbine Bonanza	L JeK	L1T	C208	C208
B412	Bell 412	L JeK	H1T	BH2	NA
B72	Boeing 720B pax	L JeK	L4J	B72	NA
B735	Boeing 737-500	L JeK	L2J	735	734
B74R	Boeing 747SR	L JeK	L4J	74V	741
B74S	Boeing 747SP	L JeK	L4J	B74S	741
BE1	Beechcraft 1900/1900C/1900D	L JeK	L2T	BE1	BE1
BE10	Beech King Air 100	L JeK	L2T	BE10	B350
BE18	Beech 18	L AvG	L2P	BE18	DHO
BE19	Beech 19 Sport	L AvG	L1P	BE19	DHO
BE2	Beechcraft twin piston engines	L AvG	L2P	BE55	DHO
BE20	Beech Huron	L JeK	L2T	BE20	BE20
BE30	Beech Super King Air 300	L JeK	L2T	BE30	B350
BE33	Beech Bonanza 33	L AvG	L1P	BE33	DHO
BE35	Beech Bonanza 35	L AvG	L1P	BE33	DHO
BE36	Beech Bonanza 36	L AvG	L1P	BE33	DHO
BE4	Beech Beechjet	L JeK	L2J	BE40	LOH
BE40	Beech Beechjet	L JeK	L2J	BE40	LOH
BE55	Beech Baron	L AvG	L2P	BE55	DHO
BE58	Beech Baron 58	L AvG	L2P	BE55	DHO
BE76	Beech Duchess	L AvG	L2P	BE55	DHO
BE95	Beech 95 Travel Air	L JeK	L2T	BE10	B350
BE9L	Beech King Air 90	L JeK	L2T	BE10	B350
BEC	Beechcraft light aircraft	L AvG	L1P	BE19	DHO
BEH	Beechcraft 1900D	L JeK	L2T	BE1	BE1
BEP	Beechcraft light aircraft - single engine	L AvG	L1P	BE19	DHO
BES	Beechcraft 1900/1900C	L JeK	L2T	BE1	BE1
BET	Beechcraft light aircraft - twin turboprop engine	L JeK	L2T	BE20	BE1
BH2	Bell Helicopters	L JeK	H1T	BH2	NA
BNI	Pilatus Britten-Norman BN-2A/B Islander	L AvG	L2P	BNI	DHO
C130	Lockheed Hercules	L JeK	L4T	C130	LOH
C150	Cessna 150	L AvG	L1P	C150	DHO
C160	Transall C-160	L JeK	L2T	C160	NA
C17	Boeing Globemaster 3	L JeK	L4J	C17	NA
C172	Cessna 172 Mescalero	L AvG	L1P	C150	DHO
C177	Cessna 177 Cardinal	L AvG	L1P	C150	DHO
C182	Cessna 182 Skylane	L AvG	L1P	C150	DHO
C185	Cessna 185 Skywagon	L AvG	L1P	C150	DHO
C206	Cessna 206 Stationair	L AvG	L1P	C150	DHO
C208	Cessna 208 Caravan	L JeK	L1T	C208	C208
C210	Cessna 210 Centurion	L AvG	L1P	C150	DHO



National Inventory Report - Portugal



Code	Aircraft Name	Fuel Type	Description	Representative	
				LTO	Cruise
C303	Cessna T303 Crusader	L AvG	L2P	C404	DHO
C310	Cessna 310	L AvG	L2P	C337	DHO
C337	Cessna 337 Super Skymaster	L AvG	L2P	C337	DHO
C402	Cessna 402 Businessliner	L AvG	L2P	C404	DHO
C404	Cessna 402 Titan	L AvG	L2P	C404	DHO
C414	Cessna 414 Chancellor	L AvG	L2P	C404	DHO
C421	Cessna 421 Executive Commuter	L AvG	L2P	C404	DHO
C425	Cessna 425 Conquest	L JeK	L2T	C425	NA
C441	Cessna 441 Conquest	L JeK	L2T	C441	NA
C500	Cessna 500 Citation	L JeK	L2J	C500	DHO
C501	Cessna 501 Citation 1SP	L JeK	L2J	C500	DHO
C510	Cessna Citation Muatang	L JeK	L2J	C500	DHO
C525	Cessna 525 Citation	L JeK	L2J	C500	DHO
C550	Cessna 550 Citation 2	L JeK	L2J	C550	DHO
C551	Cessna 551 Citation 2SP	L JeK	L2J	C551	DHO
C560	Cessna 560 Citation 5	L JeK	L2J	C560	S20
C56X	Cessna 560XL Citation Excel	L JeK	L2J	C560	S20
C650	Cessna 650 Citation 3	L JeK	L2J	C680	SH6
C680	Cessna 680 Citation Sovereign	L JeK	L2J	C680	SH6
C750	Cessna 750 Citation 10	L JeK	L2J	C750	F50
CCJ	Canadair Challenger	L JeK	L2J	CCJ	AN6
CCX	Canadair Global Express	L JeK	L2J	CR7	FRJ
CL30	BD-100 Challenge	L JeK	L2J	CL30	NA
CL4	Canadair CL-44	L JeK	L4T	CL4	F28
CN2	Cessna light aircraft - twin piston engines	L AvG	L2P	C404	DHO
CNA	Cessna light aircraft	0	0	C150	DHO
CNJ	Cessna Citation	L JeK	L2J	C500	DHO
CNT	Cessna light aircraft - twin turboprop engines	L JeK	L2T	CNT	NA
CRJ	Canadair Regional Jet	L JeK	L2J	CR1	FRJ
CRV	Aerospatiale (Sud Aviation) Se.210 Caravelle	L JeK	L2J	CRV	D94
CS2	CASA / IPTN 212 Aviocar	L JeK	L2T	CS2	NA
CS5	CASA / IPTN CN-235	L JeK	L2T	CS5	NA
CVF	Convair CV-240 / 440 / 580 / 600 / 640 Freighter	L JeK	L2T	CVF	NA
CVR	Convair CV-240 / 440 / 580 / 600 / 640 pax	L JeK	L2T	CVR	NA
CVY	Convair CV-580 / 600 / 640 Freighter	L JeK	L2T	CVY	BE1
D10	Douglas DC-10 pax	L JeK	L3J	D10	D10
D1F	Douglas DC-10 all Freighters	L JeK	L3J	D10	D10
D1X	Douglas DC-10-10 Freighter	L JeK	L3J	D11	D10
D28	Fairchild Dornier Do.228	L JeK	L2T	D28	BE20
D38	Fairchild Dornier Do.328	L JeK	L2T	FRJ	FRJ
D8F	Douglas DC-8 all Freighters	L JeK	L4J	D8T	340
D8L	Douglas DC-8-62 pax	L JeK	L4J	D8X	340
D8M	Douglas DC-8 all Combi models	L JeK	L4J	DC8	340
D8T	Douglas DC-8-50 Freighter	L JeK	L4J	D8T	340
D8Y	Douglas DC-8-71 / 72 / 73 Freighters	L JeK	L4J	D8Y	340
D9F	Douglas DC-9 all Freighters	L JeK	L2J	D9F	D91
DC3T	Douglas DC-3	L JeK	L2T	DC3T	NA
DC8	Douglas DC-8 all pax models	L JeK	L4J	DC8	340
DC9	Douglas DC-9 all pax models	L JeK	L2J	DC9	D91
DF3	Dassault (Breguet Mystere) Falcon 50 / 900	L JeK	L3J	FA50	F50
DFL	Dassault (Breguet Mystere) Falcon	0	0	FA10	S20
DH1	De Havilland Canada DHC-8-100 Dash 8 / 8Q	L JeK	L2T	DH8	DH8
DH3	De Havilland Canada DHC-8-300 Dash 8 / 8Q	L JeK	L2T	DH8	DH8
DH4	De Havilland Canada DHC-8-400 Dash 8Q	L JeK	L2T	DH8	DH8
DH7	De Havilland Canada DHC-7 Dash 7	L JeK	L4T	DH7	DH7
DH8	De Havilland Canada DHC-8 Dash 8 all models	L JeK	L2T	DH8	DH8
DHB	De Havilland Canada DHC-2 Beaver / Turbo Beaver	L AvG	L1P	DHB	DHO
DHO	De Havilland Canada DHC-3 Otter / Turbo Otter	L AvG	L1P	DHB	DHO
DHP	De Havilland Canada DHC-2 Beaver	L AvG	L1P	DHB	DHO
DHR	De Havilland Canada DHC-2 Turbo-Beaver	L AvG	L1P	DHB	DHO
DHS	De Havilland Canada DHC-3 Otter	L AvG	L1P	DHB	DHO
DHT	De Havilland Canada DHC-6 Twin Otter	L JeK	L2T	DHT	B350
DR40	Robin DN-400	L AvG	L1P	C150	DHO
E121	Embraer 121 Xingu	L JeK	L2T	E121	B350
E3CF	Boeing Sentry	L JeK	L4J	E3CF	NA
E70	Embraer 170	L JeK	L2J	EMJ	FRJ
EM2	Embraer EMB.120 Brasilia	L JeK	L2T	EM2	NA
EMB	Embraer EMB.110 Bandeirante	L JeK	L2T	EMB	EMB
EMJ	Embraer 170/190	L JeK	L2J	EMJ	FRJ



National Inventory Report - Portugal



Code	Aircraft Name	Fuel Type	Description	Representative	
				LTO	Cruise
ER3	Embraer RJ135	L JeK	L2J	ERJ	ERJ
ER4	Embraer RJ145 Amazon	L JeK	L2J	ERJ	ERJ
ERJ	Embraer RJ135 / RJ140 / RJ145	L JeK	L2J	ERJ	ERJ
F16	Lockheed F-16 Fighting Falcon	L JeK	L1J	F16	NA
F27	Fairchild FH.227	L JeK	L2T	FK7	NA
F28	Fokker F.28 Fellowship 3000	L JeK	L2J	F24	F28
F2TH	Dassault Falcon 2000	L JeK	L2J	F2TH	NA
F406	Cessna F406 Caravan 2	L JeK	L2T	F406	F406
F50	Fokker 50	L JeK	L2T	F50	F50
F70	Fokker 70	L JeK	L2J	F70	NA
F900	Dassault Falcon 900	L JeK	L3J	F900	F50
FA10	Dassault Falcon 10	L JeK	L2J	FA10	S20
FA20	Dassault Falcon 20	L JeK	L2J	FA20	S20
FA50	Dassault Falcon 50	L JeK	L3J	FA50	F50
FRJ	Fairchild Dornier 328JET	L JeK	L2J	FRJ	FRJ
GALX	IAI Galaxi	L JeK	L2J	WWP	S20
GLF2	Grumman Gulfstream 2	L JeK	L2J	GLF3	NA
GLF3	Grumman Gulfstream 3	L JeK	L2J	GLF3	NA
GLF4	Grumman Gulfstream 4	L JeK	L2J	GLF4	NA
GLF5	Grumman Gulfstream 5	L JeK	L2J	GLF5	NA
GRG	Grumman G.21 Goose	L AvG	A2P	GRG	B350
GRJ	Gulfstream Aerospace G-1159 Gulfstream II / III / IV / V	L JeK	L2J	GLF3	NA
GRS	Gulfstream Aerospace G-159 Gulfstream I	L JeK	L2T	GRS	NA
H25	British Aerospace (Hawker Siddeley) HS-125	L JeK	L2J	H25	S20
H25B	British Aerospace (Hawker Siddeley) HS-125	L JeK	L2J	H25	S20
H60	Sikorsky Black Hawk	L JeK	H2T	S61	NA
HS7	Hawker Siddeley HS.748	L JeK	L2T	HS7	FRJ
IL6	Ilyushin IL62	L JeK	L4J	IL6	340
IL7	Ilyushin IL76	L JeK	L4J	IL7	340
IL8	Ilyushin IL18	L JeK	L4T	IL8	NA
IL9	Ilyushin IL96 pax	L JeK	L4J	IL9	340
ILW	Ilyushin IL86	L JeK	L4J	ILW	340
J31	British Aerospace Jetstream 31	L JeK	L2T	J31	J31
J41	British Aerospace Jetstream 41	L JeK	L2T	J41	J41
L10	Lockheed L-1011 Tristar pax	L JeK	L3J	L10	D10
L11	Lockheed L-1011 1 / 50 / 100 / 150 / 200 / 250 Tristar pax	L JeK	L3J	L10	D10
L1F	Lockheed L-1011 Tristar Freighter	L JeK	L3J	L10	D10
L29	Aero (2) L-29 Delfin	L JeK	L1J	F16	NA
L4T	LET 410	L JeK	L2T	L4T	NA
LJ31	Learjet 31	L JeK	L2J	LJ31	S20
LJ35	Learjet 35	L JeK	L2J	LJ35	S20
LJ40	Learjet 40	L JeK	L2J	LJ35	S20
LJ45	Learjet 45	L JeK	L2J	LJ35	S20
LJ60	Learjet 60	L JeK	L2J	LJ35	S20
LOE	Lockheed L-188 Electra pax	L JeK	L4T	LOE	NA
LOF	Lockheed L-188 Electra Freighter	L JeK	L4T	LOF	NA
LOH	Lockheed L-182 / 282 / 382 (L-100) Hercules	L JeK	L4T	C130	LOH
LOM	Lockheed L-188 Electra Mixed Configuration	L JeK	L4T	LOM	NA
LRJ	Gates Learjet	L JeK	L2J	LJ23	S20
LYNX	Westland Lynx	L JeK	H2T	S61	NA
M11	McDonnell Douglas MD11 pax	L JeK	L3J	M11	D10
M1F	McDonnell Douglas MD11 Freighter	L JeK	L3J	M11	D10
M1M	McDonnell Douglas MD11 Mixed Configuration	L JeK	L3J	M11	D10
M20P	Mooney M-20	L AvG	L1P	M20P	DHO
M20T	Mooney TLS	L AvG	L1P	M20P	DHO
M80	McDonnell Douglas MD80	L JeK	L2J	M81	M82
M82	McDonnell Douglas MD82	L JeK	L2J	M82	M82
M83	McDonnell Douglas MD83	L JeK	L2J	M83	M82
M88	McDonnell Douglas MD88	L JeK	L2J	M88	M82
M90	McDonnell Douglas MD90	L JeK	L2J	M90	M82
MBH	Eurocopter (MBB) Bo.105	L JeK	H2T	S61	NA
MIH	MIL Mi-8 / Mi-17 / Mi-171 / Mil-172	L JeK	H2T	S61	NA
MU2	Mitsubishi Mu-2	L JeK	L2T	MU2	NA
ND2	Aerospatiale (Nord) 262	L JeK	L2T	ND2	NA
NDC	Aerospatiale SN.601 Corvette	L JeK	L2J	NDC	DHO
P180	Piaggio P-180 Avanti	L JeK	L2T	P180	B350
P28A	Piper Archer 2	L AvG	L1P	P28A	DHO
PA18	Piper Super Club	L AvG	L1P	PA18	DHO
PA2	Piper light aircraft - twin piston engines	L AvG	L2P	PA31	DHO



National Inventory Report - Portugal



Code	Aircraft Name	Fuel Type	Description	Representative	
				LTO	Cruise
PA24	Piper Comanche	L AvG	L1P	PA24	DHO
PA27	Piper Aztec	L AvG	L1P	PA27	DHO
PA3	Piper Twin Comanche	L AvG	L2P	PA31	DHO
PA31	Piper Navajo	L AvG	L2P	PA31	DHO
PA32	Piper Saratoga	L AvG	L1P	PA32	DHO
PA34	Piper Seneca	L AvG	L2P	PA44	DHO
PA44	Piper Seminole	L AvG	L2P	PA44	DHO
PA46	Piper Malibu	L AvG	L1P	PA46	DHO
PAG	Piper light aircraft	L AvG	L1P	P28A	DHO
PAT4	Piper T-1040	L JeK	L2T	PAT4	SWM
PL2	Pilatus PC-12	L JeK	L1T	PL2	C208
PL6	Pilatus PC-6 Turbo Porter	L JeK	L1T	PL6	C208
PN6	Partenavia P.68	L AvG	L2P	PN6	DHO
PUMA	Aerospatile Puma	L JeK	H2T	S61	NA
S05F	Siai-Marchetti S-205-20F	L AvG	L1P	C150	DHO
S20	Saab 2000	L JeK	L2T	S20	S20
S58	Sikorsky S-58T	L JeK	H1T	S58	NA
S58P	Sikorsky S-58	L AvG	H1P	S61	NA
S61	Sikorsky S-61	L JeK	H2T	S61	NA
S76	Sikorsky S-76	L JeK	H2T	S61	NA
SA3	Stits Playboy	L AvG	L1P	SA3	DHO
SBR1	North American Sabreliner	L JeK	L2J	SBR1	NA
SF3	Saab SF340A/B	L JeK	L2T	SF3	SF3
SH3	Shorts SD.330	L JeK	L2T	SH3	SH3
SH6	Shorts SD.360	L JeK	L2T	SH6	SH6
SHB	Shorts SC-5 Belfast	L JeK	L4T	SHB	NA
SR20	Cirrus SR-20	L AvG	L1P	C150	DHO
SR22	Cirrus SR-22	L AvG	L1P	C150	DHO
SSC	Aerospatiale/BAC Concorde	L JeK	L4J	SSC	NA
SW2	Swearingen Merlin 2	L JeK	L2T	SW2	NA
SW3	Swearingen Merlin 3	L JeK	L2T	SW3	SHS
SW4	Swearingen Merlin 4	L JeK	L2T	SW4	NA
SWM	Fairchild (Swearingen) SA26 / SA226 / SA227 Metro / Merlin / Expediter	L JeK	L2T	PA31	SWM
T20	Tupolev Tu-204 / Tu-214	L JeK	L2J	T20	NA
TBM	Grumman Avenger	L AvG	L1P	C150	NA
TBM7	Socata TBM-700	L JeK	L1T	TBM7	C208
TOBA	Socata Tobago	L AvG	L1P	C150	DHO
TRIN	Scata Pashosh	L AvG	L1P	C150	DHO
TU3	Tupolev Tu134	L JeK	L2J	TU3	NA
TU5	Tupolev Tu154	L JeK	L3J	TU5	727
VC10	Bac VC-10	L JeK	L4J	VC10	NA
VCV	Vickers Viscount	L JeK	L4T	VCV	NA
WG30	Westland WG-30	L JeK	H2T	S61	NA
WWP	Israel Aircraft Industries 1124 Westwind	L JeK	L2J	WWP	S20
YK2	Yakovlev Yak 42	L JeK	L3J	YK2	NA
YK4	Yakovlev Yak 40	L JeK	L3J	YK4	NA
YK5	Yakovlev Yak 50	L AvG	L1P	C150	DHO



National Inventory Report – Portugal



Table B-3: Road transportation energy based implied emission factors (t/TJ) for 2021

Category	Fuel	Segment	Euro Standard	CO2 fossil t/TJ	CH4 t/TJ	N2O t/TJ
Passenger Cars	Petrol	Mini	Euro 4	71.19	0.00869	0.00089
Passenger Cars	Petrol	Mini	Euro 5	71.25	0.00870	0.00057
Passenger Cars	Petrol	Mini	Euro 6 a/b/c	71.29	0.00870	0.00053
Passenger Cars	Petrol	Mini	Euro 6 d-temp	71.39	0.00872	0.00052
Passenger Cars	Petrol	Mini	Euro 6 d	71.45	0.00872	0.00050
Passenger Cars	Petrol	Small	PRE ECE - ECE 15/04	69.88	0.04047	0.00287
Passenger Cars	Petrol	Small	Euro 1	70.71	0.00968	0.00481
Passenger Cars	Petrol	Small	Euro 2	70.82	0.01425	0.00280
Passenger Cars	Petrol	Small	Euro 3	71.09	0.01033	0.00106
Passenger Cars	Petrol	Small	Euro 4	71.18	0.00731	0.00075
Passenger Cars	Petrol	Small	Euro 5	71.25	0.00732	0.00049
Passenger Cars	Petrol	Small	Euro 6 a/b/c	71.30	0.00732	0.00045
Passenger Cars	Petrol	Small	Euro 6 d-temp	71.38	0.00733	0.00045
Passenger Cars	Petrol	Small	Euro 6 d	71.44	0.00734	0.00042
Passenger Cars	Petrol	Medium	PRE ECE - ECE 15/04	70.02	0.03386	0.00240
Passenger Cars	Petrol	Medium	Euro 1	71.24	0.00818	0.00411
Passenger Cars	Petrol	Medium	Euro 2	71.28	0.01256	0.00251
Passenger Cars	Petrol	Medium	Euro 3	71.34	0.00869	0.00090
Passenger Cars	Petrol	Medium	Euro 4	71.35	0.00625	0.00064
Passenger Cars	Petrol	Medium	Euro 5	71.36	0.00625	0.00042
Passenger Cars	Petrol	Medium	Euro 6 a/b/c	71.37	0.00625	0.00039
Passenger Cars	Petrol	Medium	Euro 6 d-temp	71.39	0.00625	0.00037
Passenger Cars	Petrol	Medium	Euro 6 d	71.42	0.00625	0.00035
Passenger Cars	Petrol	Large-SUV-Executive	PRE ECE - ECE 15/04	69.87	0.02702	0.00191
Passenger Cars	Petrol	Large-SUV-Executive	Euro 1	71.28	0.00635	0.00317
Passenger Cars	Petrol	Large-SUV-Executive	Euro 2	71.31	0.00921	0.00182
Passenger Cars	Petrol	Large-SUV-Executive	Euro 3	71.35	0.00741	0.00076
Passenger Cars	Petrol	Large-SUV-Executive	Euro 4	71.36	0.00458	0.00047
Passenger Cars	Petrol	Large-SUV-Executive	Euro 5	71.38	0.00458	0.00030
Passenger Cars	Petrol	Large-SUV-Executive	Euro 6 a/b/c	71.39	0.00458	0.00028
Passenger Cars	Petrol	Large-SUV-Executive	Euro 6 d-temp	71.40	0.00458	0.00027
Passenger Cars	Petrol	Large-SUV-Executive	Euro 6 d	71.39	0.00458	0.00026
Passenger Cars	Petrol Hybrid	All Segments	Euro 4	71.35	0.01027	0.00108
Passenger Cars	Petrol Hybrid	All Segments	Euro 5	71.45	0.00995	0.00104
Passenger Cars	Petrol Hybrid	All Segments	Euro 6 a/b/c	71.43	0.01010	0.00102
Passenger Cars	Petrol Hybrid	All Segments	Euro 6 d-temp	71.42	0.01013	0.00100
Passenger Cars	Petrol Hybrid	All Segments	Euro 6 d	71.46	0.01012	0.00099
Passenger Cars	Diesel	Mini	Euro 4	69.29	0.00030	0.00489
Passenger Cars	Diesel	Mini	Euro 5	69.29	0.00002	0.00489
Passenger Cars	Diesel	Mini	Euro 6 a/b/c	69.34	0.00002	0.00397
Passenger Cars	Diesel	Mini	Euro 6 d-temp	69.33	0.00002	0.00397
Passenger Cars	Diesel	Small	Conventional	69.16	0.00525	-
Passenger Cars	Diesel	Small	Euro 1	69.20	0.00405	0.00098
Passenger Cars	Diesel	Small	Euro 2	69.19	0.00162	0.00183
Passenger Cars	Diesel	Small	Euro 3	69.20	0.00056	0.00329
Passenger Cars	Diesel	Small	Euro 4	69.20	0.00020	0.00329
Passenger Cars	Diesel	Small	Euro 5	69.20	0.00001	0.00329



National Inventory Report – Portugal



Category	Fuel	Segment	Euro Standard	CO2 fossil t/TJ	CH4 t/TJ	N2O t/TJ
Passenger Cars	Diesel	Small	Euro 6 a/b/c	69.25	0.00001	0.00268
Passenger Cars	Diesel	Small	Euro 6 d-temp	69.24	0.00001	0.00268
Passenger Cars	Diesel	Small	Euro 6 d	69.24	0.00001	0.00268
Passenger Cars	Diesel	Medium	Conventional	69.16	0.00525	-
Passenger Cars	Diesel	Medium	Euro 1	69.20	0.00405	0.00098
Passenger Cars	Diesel	Medium	Euro 2	69.19	0.00162	0.00183
Passenger Cars	Diesel	Medium	Euro 3	69.20	0.00056	0.00329
Passenger Cars	Diesel	Medium	Euro 4	69.20	0.00020	0.00329
Passenger Cars	Diesel	Medium	Euro 5	69.20	0.00001	0.00329
Passenger Cars	Diesel	Medium	Euro 6 a/b/c	69.25	0.00001	0.00268
Passenger Cars	Diesel	Medium	Euro 6 d-temp	69.24	0.00001	0.00268
Passenger Cars	Diesel	Medium	Euro 6 d	69.24	0.00001	0.00268
Passenger Cars	Diesel	Large-SUV-Executive	Conventional	69.16	0.00525	-
Passenger Cars	Diesel	Large-SUV-Executive	Euro 1	69.15	0.00303	0.00073
Passenger Cars	Diesel	Large-SUV-Executive	Euro 2	69.15	0.00125	0.00142
Passenger Cars	Diesel	Large-SUV-Executive	Euro 3	69.15	0.00040	0.00240
Passenger Cars	Diesel	Large-SUV-Executive	Euro 4	69.15	0.00015	0.00240
Passenger Cars	Diesel	Large-SUV-Executive	Euro 5	69.15	0.00001	0.00240
Passenger Cars	Diesel	Large-SUV-Executive	Euro 6 a/b/c	69.20	0.00001	0.00195
Passenger Cars	Diesel	Large-SUV-Executive	Euro 6 d-temp	69.20	0.00001	0.00195
Passenger Cars	Diesel	Large-SUV-Executive	Euro 6 d	69.19	0.00001	0.00195
Passenger Cars	LPG Bifuel	All Segments	Conventional	65.09	0.01875	-
Passenger Cars	LPG Bifuel	All Segments	Euro 1	65.09	0.01776	-
Passenger Cars	LPG Bifuel	All Segments	Euro 2	65.09	0.01050	-
Passenger Cars	LPG Bifuel	All Segments	Euro 3	65.09	0.00894	-
Passenger Cars	LPG Bifuel	All Segments	Euro 4	65.09	0.00861	-
Passenger Cars	LPG Bifuel	All Segments	Euro 5	65.09	0.00861	-
Passenger Cars	LPG Bifuel	All Segments	Euro 6 a/b/c	65.08	0.00861	-
Passenger Cars	LPG Bifuel	All Segments	Euro 6 d-temp	65.07	0.00861	-
Light Commercial Vehicles	Petrol	N1-I	Conventional	69.83	0.03030	0.00215
Light Commercial Vehicles	Petrol	N1-I	Euro 1	71.21	0.00975	0.00491
Light Commercial Vehicles	Petrol	N1-I	Euro 2	71.22	0.01427	0.00281
Light Commercial Vehicles	Petrol	N1-I	Euro 3	71.33	0.01033	0.00107
Light Commercial Vehicles	Petrol	N1-I	Euro 4	71.37	0.00659	0.00075
Light Commercial Vehicles	Petrol	N1-I	Euro 5	71.36	0.00659	0.00048
Light Commercial Vehicles	Petrol	N1-I	Euro 6 a/b/c	71.40	0.00660	0.00047
Light Commercial Vehicles	Petrol	N1-I	Euro 6 d-temp	71.43	0.00660	0.00045
Light Commercial Vehicles	Petrol	N1-II & N1-III	Conventional	69.85	0.02659	0.00188
Light Commercial Vehicles	Petrol	N1-II & N1-III	Euro 1	71.28	0.00502	0.00527
Light Commercial Vehicles	Petrol	N1-II & N1-III	Euro 2	71.32	0.00735	0.00656
Light Commercial Vehicles	Petrol	N1-II & N1-III	Euro 3	71.30	0.00534	0.00129
Light Commercial Vehicles	Petrol	N1-II & N1-III	Euro 4	71.37	0.00354	0.00087
Light Commercial Vehicles	Petrol	N1-II & N1-III	Euro 5	71.41	0.00564	0.00045
Light Commercial Vehicles	Petrol	N1-II & N1-III	Euro 6 a/b/c	71.40	0.00564	0.00040
Light Commercial Vehicles	Petrol	N1-II & N1-III	Euro 6 d-temp	71.41	0.00564	0.00039
Light Commercial Vehicles	Diesel	N1-I	Conventional	69.16	0.00525	-
Light Commercial Vehicles	Diesel	N1-I	Euro 1	69.20	0.00405	0.00098
Light Commercial Vehicles	Diesel	N1-I	Euro 2	69.19	0.00162	0.00183
Light Commercial Vehicles	Diesel	N1-I	Euro 3	69.20	0.00056	0.00329
Light Commercial Vehicles	Diesel	N1-I	Euro 4	69.20	0.00020	0.00329
Light Commercial Vehicles	Diesel	N1-I	Euro 5	69.20	0.00001	0.00329



National Inventory Report – Portugal



Category	Fuel	Segment	Euro Standard	CO2 fossil t/TJ	CH4 t/TJ	N2O t/TJ
Light Commercial Vehicles	Diesel	N1-I	Euro 6 a/b/c	69.25	0.00001	0.00268
Light Commercial Vehicles	Diesel	N1-I	Euro 6 d-temp	69.24	0.00001	0.00268
Light Commercial Vehicles	Diesel	N1-I	Euro 6 d	69.24	0.00001	0.00268
Light Commercial Vehicles	Diesel	N1-II & N1-III	Conventional	69.12	0.00380	-
Light Commercial Vehicles	Diesel	N1-II & N1-III	Euro 1	69.13	0.00265	0.00064
Light Commercial Vehicles	Diesel	N1-II & N1-III	Euro 2	69.13	0.00109	0.00124
Light Commercial Vehicles	Diesel	N1-II & N1-III	Euro 3	69.13	0.00035	0.00210
Light Commercial Vehicles	Diesel	N1-II & N1-III	Euro 4	69.13	0.00013	0.00210
Light Commercial Vehicles	Diesel	N1-II & N1-III	Euro 5	69.14	0.00000	0.00227
Light Commercial Vehicles	Diesel	N1-II & N1-III	Euro 6 a/b/c	69.19	0.00000	0.00185
Light Commercial Vehicles	Diesel	N1-II & N1-III	Euro 6 d-temp	69.19	0.00000	0.00185
Light Commercial Vehicles	Diesel	N1-II & N1-III	Euro 6 d	69.18	0.00000	0.00185
Heavy Duty Trucks	Diesel	<=20 t	Conventional	69.07	0.00890	0.00370
Heavy Duty Trucks	Diesel	<=20 t	Euro I	69.08	0.01073	0.00098
Heavy Duty Trucks	Diesel	<=20 t	Euro II	69.08	0.00828	0.00094
Heavy Duty Trucks	Diesel	<=20 t	Euro III	69.07	0.00856	0.00053
Heavy Duty Trucks	Diesel	<=20 t	Euro IV	69.41	0.00058	0.00147
Heavy Duty Trucks	Diesel	<=20 t	Euro V	69.41	0.00062	0.00436
Heavy Duty Trucks	Diesel	<=20 t	Euro VI A/B/C	69.33	0.00062	0.00435
Heavy Duty Trucks	Diesel	<=20 t	Euro VI D/E	69.33	0.00062	0.00435
Heavy Duty Trucks	Diesel	20 - 28 t	Conventional	69.05	0.00862	0.00239
Heavy Duty Trucks	Diesel	20 - 28 t	Euro I	69.06	0.00992	0.00080
Heavy Duty Trucks	Diesel	20 - 28 t	Euro II	69.06	0.00776	0.00078
Heavy Duty Trucks	Diesel	20 - 28 t	Euro III	69.06	0.00705	0.00041
Heavy Duty Trucks	Diesel	20 - 28 t	Euro IV	69.39	0.00046	0.00111
Heavy Duty Trucks	Diesel	20 - 28 t	Euro V	69.39	0.00047	0.00325
Heavy Duty Trucks	Diesel	20 - 28 t	Euro VI A/B/C	69.31	0.00046	0.00321
Heavy Duty Trucks	Diesel	20 - 28 t	Euro VI D/E	69.31	0.00046	0.00321
Heavy Duty Trucks	Diesel	>28 t	Conventional	69.04	0.00709	0.00197
Heavy Duty Trucks	Diesel	>28 t	Euro I	69.05	0.00792	0.00102
Heavy Duty Trucks	Diesel	>28 t	Euro II	69.05	0.00612	0.00101
Heavy Duty Trucks	Diesel	>28 t	Euro III	69.05	0.00575	0.00057
Heavy Duty Trucks	Diesel	>28 t	Euro IV	69.39	0.00040	0.00150
Heavy Duty Trucks	Diesel	>28 t	Euro V	69.39	0.00041	0.00435
Heavy Duty Trucks	Diesel	>28 t	Euro VI A/B/C	69.31	0.00041	0.00432
Heavy Duty Trucks	Diesel	>28 t	Euro VI D/E	69.31	0.00041	0.00432
Buses	Diesel	Urban Buses	Conventional	69.13	0.00764	0.00131
Buses	Diesel	Urban Buses	Euro I	69.14	0.00869	0.00060
Buses	Diesel	Urban Buses	Euro II	69.15	0.00595	0.00063
Buses	Diesel	Urban Buses	Euro III	69.15	0.00526	0.00031
Buses	Diesel	Urban Buses	Euro IV	69.50	0.00031	0.00075
Buses	Diesel	Urban Buses	Euro V	69.50	0.00030	0.00190
Buses	Diesel	Urban Buses	Euro VI A/B/C	69.36	0.00029	0.00228
Buses	Diesel	Urban Buses	Euro VI D/E	69.36	0.00029	0.00227
Buses	Diesel	Coaches	Conventional	69.07	0.00760	0.00303
Buses	Diesel	Coaches	Euro I	69.08	0.00802	0.00086
Buses	Diesel	Coaches	Euro II	69.08	0.00518	0.00080
Buses	Diesel	Coaches	Euro III	69.08	0.00466	0.00048
Buses	Diesel	Coaches	Euro IV	69.41	0.00024	0.00134
Buses	Diesel	Coaches	Euro V	69.41	0.00023	0.00371
Buses	Diesel	Coaches	Euro VI A/B/C	69.32	0.00022	0.00339



National Inventory Report – Portugal



Category	Fuel	Segment	Euro Standard	CO2 fossil t/TJ	CH4 t/TJ	N2O t/TJ
Buses	Diesel	Coaches	Euro VI D/E	69.32	0.00022	0.00339
Buses	CNG	Urban CNG Buses	Euro I	57.25	0.25526	0.03754
Buses	CNG	Urban CNG Buses	Euro III	57.27	0.05861	0.04579
Buses	CNG	Urban CNG Buses	EEV	57.27	0.04174	0.04259
L-Category	Petrol	Mopeds 2-stroke <50 cm ³	Conventional	70.83	0.19087	0.00087
L-Category	Petrol	Mopeds 2-stroke <50 cm ³	Euro 1	71.99	0.04803	0.00110
L-Category	Petrol	Mopeds 2-stroke <50 cm ³	Euro 2	72.51	0.02661	0.00110
L-Category	Petrol	Mopeds 2-stroke <50 cm ³	Euro 3	73.43	0.02204	0.00112
L-Category	Petrol	Mopeds 2-stroke <50 cm ³	Euro 4	73.94	0.02220	0.00113
L-Category	Petrol	Mopeds 2-stroke <50 cm ³	Euro 5	73.28	0.02200	0.00112
L-Category	Petrol	Mopeds 4-stroke <50 cm ³	Conventional	70.83	0.19087	0.00087
L-Category	Petrol	Mopeds 4-stroke <50 cm ³	Euro 1	71.99	0.04803	0.00110
L-Category	Petrol	Mopeds 4-stroke <50 cm ³	Euro 2	72.51	0.02661	0.00110
L-Category	Petrol	Mopeds 4-stroke <50 cm ³	Euro 3	73.84	0.02643	0.00134
L-Category	Petrol	Mopeds 4-stroke <50 cm ³	Euro 4	74.53	0.02721	0.00138
L-Category	Petrol	Mopeds 4-stroke <50 cm ³	Euro 5	73.71	0.02691	0.00137
L-Category	Petrol	Motorcycles 2-stroke >50 cm ³	Conventional	71.42	0.09789	0.00131
L-Category	Petrol	Motorcycles 2-stroke >50 cm ³	Euro 1	72.12	0.07150	0.00142
L-Category	Petrol	Motorcycles 2-stroke >50 cm ³	Euro 2	72.39	0.02171	0.00143
L-Category	Petrol	Motorcycles 2-stroke >50 cm ³	Euro 3	73.63	0.01391	0.00225
L-Category	Petrol	Motorcycles 2-stroke >50 cm ³	Euro 4	73.94	0.01349	0.00218
L-Category	Petrol	Motorcycles 2-stroke >50 cm ³	Euro 5	73.46	0.01340	0.00217
L-Category	Petrol	Motorcycles 4-stroke <250 cm ³	Conventional	70.47	0.13469	0.00135
L-Category	Petrol	Motorcycles 4-stroke <250 cm ³	Euro 1	70.66	0.11455	0.00164
L-Category	Petrol	Motorcycles 4-stroke <250 cm ³	Euro 2	70.69	0.11065	0.00197
L-Category	Petrol	Motorcycles 4-stroke <250 cm ³	Euro 3	70.89	0.06077	0.00227
L-Category	Petrol	Motorcycles 4-stroke <250 cm ³	Euro 4	71.10	0.05366	0.00200
L-Category	Petrol	Motorcycles 4-stroke <250 cm ³	Euro 5	70.89	0.05350	0.00200
L-Category	Petrol	Motorcycles 4-stroke 250 - 750 cm ³	Conventional	70.38	0.09810	0.00098
L-Category	Petrol	Motorcycles 4-stroke 250 - 750 cm ³	Euro 1	70.67	0.08124	0.00104
L-Category	Petrol	Motorcycles 4-stroke 250 - 750 cm ³	Euro 2	70.75	0.07748	0.00113
L-Category	Petrol	Motorcycles 4-stroke 250 - 750 cm ³	Euro 3	70.99	0.02561	0.00080
L-Category	Petrol	Motorcycles 4-stroke 250 - 750 cm ³	Euro 4	71.05	0.03053	0.00096
L-Category	Petrol	Motorcycles 4-stroke 250 - 750 cm ³	Euro 5	70.86	0.03045	0.00095
L-Category	Petrol	Motorcycles 4-stroke >750 cm ³	Conventional	70.04	0.08552	0.00086
L-Category	Petrol	Motorcycles 4-stroke >750 cm ³	Euro 1	70.41	0.05065	0.00092
L-Category	Petrol	Motorcycles 4-stroke >750 cm ³	Euro 2	70.58	0.03859	0.00092
L-Category	Petrol	Motorcycles 4-stroke >750 cm ³	Euro 3	70.87	0.01490	0.00080
L-Category	Petrol	Motorcycles 4-stroke >750 cm ³	Euro 4	70.94	0.01773	0.00095
L-Category	Petrol	Motorcycles 4-stroke >750 cm ³	Euro 5	70.75	0.01768	0.00095



National Inventory Report – Portugal



Table B-4: Road transportation distance based implied emission factor for 2021 (g/km and mg/km)

Category	Fuel	Segment	Euro Standard	CO ₂ fossil g/km	CH ₄ mg/km	N ₂ O mg/km
Passenger Cars	Petrol	Mini	Euro 4	163.17	19.918	2.04
Passenger Cars	Petrol	Mini	Euro 5	163.17	19.918	1.31
Passenger Cars	Petrol	Mini	Euro 6 a/b/c	163.15	19.918	1.21
Passenger Cars	Petrol	Mini	Euro 6 d-temp	163.14	19.918	1.20
Passenger Cars	Petrol	Mini	Euro 6 d	163.13	19.918	1.13
Passenger Cars	Petrol	Small	PRE ECE - ECE 15/04	197.20	114.216	8.10
Passenger Cars	Petrol	Small	Euro 1	187.85	25.723	12.79
Passenger Cars	Petrol	Small	Euro 2	186.87	37.588	7.38
Passenger Cars	Petrol	Small	Euro 3	188.14	27.335	2.80
Passenger Cars	Petrol	Small	Euro 4	193.95	19.918	2.05
Passenger Cars	Petrol	Small	Euro 5	193.95	19.918	1.33
Passenger Cars	Petrol	Small	Euro 6 a/b/c	193.93	19.918	1.23
Passenger Cars	Petrol	Small	Euro 6 d-temp	193.92	19.918	1.21
Passenger Cars	Petrol	Small	Euro 6 d	193.90	19.918	1.14
Passenger Cars	Petrol	Medium	PRE ECE - ECE 15/04	236.15	114.216	8.10
Passenger Cars	Petrol	Medium	Euro 1	224.01	25.723	12.93
Passenger Cars	Petrol	Medium	Euro 2	213.30	37.588	7.50
Passenger Cars	Petrol	Medium	Euro 3	224.39	27.335	2.82
Passenger Cars	Petrol	Medium	Euro 4	227.56	19.918	2.05
Passenger Cars	Petrol	Medium	Euro 5	227.56	19.918	1.33
Passenger Cars	Petrol	Medium	Euro 6 a/b/c	227.54	19.918	1.23
Passenger Cars	Petrol	Medium	Euro 6 d-temp	227.53	19.918	1.18
Passenger Cars	Petrol	Medium	Euro 6 d	227.51	19.918	1.13
Passenger Cars	Petrol	Large-SUV-Executive	PRE ECE - ECE 15/04	295.39	114.216	8.10
Passenger Cars	Petrol	Large-SUV-Executive	Euro 1	288.53	25.723	12.83
Passenger Cars	Petrol	Large-SUV-Executive	Euro 2	290.96	37.588	7.44
Passenger Cars	Petrol	Large-SUV-Executive	Euro 3	263.27	27.335	2.80
Passenger Cars	Petrol	Large-SUV-Executive	Euro 4	310.63	19.918	2.05
Passenger Cars	Petrol	Large-SUV-Executive	Euro 5	310.63	19.918	1.32
Passenger Cars	Petrol	Large-SUV-Executive	Euro 6 a/b/c	310.61	19.918	1.23
Passenger Cars	Petrol	Large-SUV-Executive	Euro 6 d-temp	310.60	19.918	1.16
Passenger Cars	Petrol	Large-SUV-Executive	Euro 6 d	310.58	19.918	1.12
Passenger Cars	Petrol Hybrid	All Segments	Euro 4	138.44	19.918	2.09
Passenger Cars	Petrol Hybrid	All Segments	Euro 5	142.99	19.918	2.08
Passenger Cars	Petrol Hybrid	All Segments	Euro 6 a/b/c	140.92	19.918	2.01
Passenger Cars	Petrol Hybrid	All Segments	Euro 6 d-temp	140.46	19.918	1.97
Passenger Cars	Petrol Hybrid	All Segments	Euro 6 d	140.68	19.918	1.95
Passenger Cars	Diesel	Mini	Euro 4	114.85	0.501	8.10
Passenger Cars	Diesel	Mini	Euro 5	114.85	0.034	8.10
Passenger Cars	Diesel	Mini	Euro 6 a/b/c	114.92	0.034	6.58
Passenger Cars	Diesel	Mini	Euro 6 d-temp	114.91	0.034	6.58
Passenger Cars	Diesel	Small	Conventional	214.45	16.270	-
Passenger Cars	Diesel	Small	Euro 1	174.86	10.231	2.48
Passenger Cars	Diesel	Small	Euro 2	180.49	4.219	4.78
Passenger Cars	Diesel	Small	Euro 3	170.20	1.368	8.10
Passenger Cars	Diesel	Small	Euro 4	170.20	0.501	8.10
Passenger Cars	Diesel	Small	Euro 5	170.20	0.034	8.10



National Inventory Report – Portugal



Category	Fuel	Segment	Euro Standard	CO2 fossil g/km	CH4 mg/km	N2O mg/km
Passenger Cars	Diesel	Small	Euro 6 a/b/c	170.32	0.034	6.58
Passenger Cars	Diesel	Small	Euro 6 d-temp	170.31	0.034	6.58
Passenger Cars	Diesel	Small	Euro 6 d	170.29	0.034	6.58
Passenger Cars	Diesel	Medium	Conventional	214.45	16.270	-
Passenger Cars	Diesel	Medium	Euro 1	174.86	10.231	2.48
Passenger Cars	Diesel	Medium	Euro 2	180.49	4.219	4.78
Passenger Cars	Diesel	Medium	Euro 3	170.20	1.368	8.10
Passenger Cars	Diesel	Medium	Euro 4	170.20	0.501	8.10
Passenger Cars	Diesel	Medium	Euro 5	170.20	0.034	8.10
Passenger Cars	Diesel	Medium	Euro 6 a/b/c	170.32	0.034	6.58
Passenger Cars	Diesel	Medium	Euro 6 d-temp	170.31	0.034	6.58
Passenger Cars	Diesel	Medium	Euro 6 d	170.29	0.034	6.58
Passenger Cars	Diesel	Large-SUV-Executive	Conventional	214.45	16.270	-
Passenger Cars	Diesel	Large-SUV-Executive	Euro 1	233.74	10.231	2.48
Passenger Cars	Diesel	Large-SUV-Executive	Euro 2	233.74	4.219	4.78
Passenger Cars	Diesel	Large-SUV-Executive	Euro 3	233.74	1.368	8.10
Passenger Cars	Diesel	Large-SUV-Executive	Euro 4	233.74	0.501	8.10
Passenger Cars	Diesel	Large-SUV-Executive	Euro 5	233.74	0.034	8.10
Passenger Cars	Diesel	Large-SUV-Executive	Euro 6 a/b/c	233.91	0.034	6.58
Passenger Cars	Diesel	Large-SUV-Executive	Euro 6 d-temp	233.90	0.034	6.58
Passenger Cars	Diesel	Large-SUV-Executive	Euro 6 d	233.88	0.034	6.58
Passenger Cars	LPG Bifuel	All Segments	Conventional	182.25	52.506	-
Passenger Cars	LPG Bifuel	All Segments	Euro 1	192.40	52.506	-
Passenger Cars	LPG Bifuel	All Segments	Euro 6 d-temp	192.40	31.052	-
Passenger Cars	LPG Bifuel	All Segments	Euro 3	192.40	26.424	-
Passenger Cars	LPG Bifuel	All Segments	Euro 4	192.40	25.444	-
Passenger Cars	LPG Bifuel	All Segments	Euro 5	192.40	25.444	-
Passenger Cars	LPG Bifuel	All Segments	Euro 6 a/b/c	192.38	25.444	-
Passenger Cars	LPG Bifuel	All Segments	Euro 6 d-temp	192.37	25.444	-
Light Commercial Vehicles	Petrol	N1-I	Conventional	263.23	114.216	8.10
Light Commercial Vehicles	Petrol	N1-I	Euro 1	187.85	25.723	12.96
Light Commercial Vehicles	Petrol	N1-I	Euro 2	187.55	37.588	7.40
Light Commercial Vehicles	Petrol	N1-I	Euro 3	188.80	27.335	2.84
Light Commercial Vehicles	Petrol	N1-I	Euro 4	195.78	18.089	2.07
Light Commercial Vehicles	Petrol	N1-I	Euro 5	195.78	18.089	1.32
Light Commercial Vehicles	Petrol	N1-I	Euro 6 a/b/c	195.76	18.089	1.29
Light Commercial Vehicles	Petrol	N1-I	Euro 6 d-temp	195.75	18.089	1.22
Light Commercial Vehicles	Petrol	N1-II & N1-III	Conventional	300.09	114.216	8.10
Light Commercial Vehicles	Petrol	N1-II & N1-III	Euro 1	364.94	25.723	26.98
Light Commercial Vehicles	Petrol	N1-II & N1-III	Euro 2	364.94	37.588	33.56
Light Commercial Vehicles	Petrol	N1-II & N1-III	Euro 3	364.94	27.335	6.62
Light Commercial Vehicles	Petrol	N1-II & N1-III	Euro 4	364.94	18.089	4.46
Light Commercial Vehicles	Petrol	N1-II & N1-III	Euro 5	229.14	18.089	1.44
Light Commercial Vehicles	Petrol	N1-II & N1-III	Euro 6 a/b/c	229.12	18.089	1.28
Light Commercial Vehicles	Petrol	N1-II & N1-III	Euro 6 d-temp	229.11	18.089	1.25
Light Commercial Vehicles	Diesel	N1-I	Conventional	214.45	16.270	-
Light Commercial Vehicles	Diesel	N1-I	Euro 1	174.86	10.231	2.48
Light Commercial Vehicles	Diesel	N1-I	Euro 2	180.49	4.219	4.78
Light Commercial Vehicles	Diesel	N1-I	Euro 3	170.20	1.368	8.10
Light Commercial Vehicles	Diesel	N1-I	Euro 4	170.20	0.501	8.10
Light Commercial Vehicles	Diesel	N1-I	Euro 5	170.20	0.024	8.10



National Inventory Report – Portugal



Category	Fuel	Segment	Euro Standard	CO2 fossil g/km	CH4 mg/km	N2O mg/km
Light Commercial Vehicles	Diesel	N1-I	Euro 6 a/b/c	170.32	0.024	6.58
Light Commercial Vehicles	Diesel	N1-I	Euro 6 d-temp	170.31	0.024	6.58
Light Commercial Vehicles	Diesel	N1-I	Euro 6 d	170.29	0.024	6.58
Light Commercial Vehicles	Diesel	N1-II & N1-III	Conventional	295.98	16.270	-
Light Commercial Vehicles	Diesel	N1-II & N1-III	Euro 1	266.62	10.231	2.48
Light Commercial Vehicles	Diesel	N1-II & N1-III	Euro 2	266.62	4.219	4.78
Light Commercial Vehicles	Diesel	N1-II & N1-III	Euro 3	266.62	1.368	8.10
Light Commercial Vehicles	Diesel	N1-II & N1-III	Euro 4	266.62	0.501	8.10
Light Commercial Vehicles	Diesel	N1-II & N1-III	Euro 5	246.37	0.003	8.10
Light Commercial Vehicles	Diesel	N1-II & N1-III	Euro 6 a/b/c	246.55	0.003	6.58
Light Commercial Vehicles	Diesel	N1-II & N1-III	Euro 6 d-temp	246.54	0.003	6.58
Light Commercial Vehicles	Diesel	N1-II & N1-III	Euro 6 d	246.52	0.003	6.58
Heavy Duty Trucks	Diesel	<=20 t	Conventional	559.31	72.071	30.00
Heavy Duty Trucks	Diesel	<=20 t	Euro I	495.93	77.050	7.07
Heavy Duty Trucks	Diesel	<=20 t	Euro II	486.41	58.280	6.63
Heavy Duty Trucks	Diesel	<=20 t	Euro III	548.95	68.059	4.22
Heavy Duty Trucks	Diesel	<=20 t	Euro IV	535.91	4.501	11.36
Heavy Duty Trucks	Diesel	<=20 t	Euro V	522.00	4.627	32.78
Heavy Duty Trucks	Diesel	<=20 t	Euro VI A/B/C	526.60	4.690	33.04
Heavy Duty Trucks	Diesel	<=20 t	Euro VI D/E	527.70	4.716	33.13
Heavy Duty Trucks	Diesel	20 - 28 t	Conventional	865.23	108.037	30.00
Heavy Duty Trucks	Diesel	20 - 28 t	Euro I	752.29	108.037	8.75
Heavy Duty Trucks	Diesel	20 - 28 t	Euro II	730.99	82.096	8.28
Heavy Duty Trucks	Diesel	20 - 28 t	Euro III	759.26	77.493	4.53
Heavy Duty Trucks	Diesel	20 - 28 t	Euro IV	734.72	4.819	11.77
Heavy Duty Trucks	Diesel	20 - 28 t	Euro V	715.97	4.819	33.50
Heavy Duty Trucks	Diesel	20 - 28 t	Euro VI A/B/C	725.52	4.819	33.60
Heavy Duty Trucks	Diesel	20 - 28 t	Euro VI D/E	726.24	4.819	33.60
Heavy Duty Trucks	Diesel	>28 t	Conventional	1 051.81	108.037	30.00
Heavy Duty Trucks	Diesel	>28 t	Euro I	941.32	108.037	13.95
Heavy Duty Trucks	Diesel	>28 t	Euro II	926.41	82.096	13.52
Heavy Duty Trucks	Diesel	>28 t	Euro III	931.18	77.493	7.72
Heavy Duty Trucks	Diesel	>28 t	Euro IV	842.64	4.819	18.25
Heavy Duty Trucks	Diesel	>28 t	Euro V	820.25	4.819	51.37
Heavy Duty Trucks	Diesel	>28 t	Euro VI A/B/C	824.12	4.819	51.40
Heavy Duty Trucks	Diesel	>28 t	Euro VI D/E	824.21	4.819	51.40
Buses	Diesel	Urban Buses	Conventional	1 582.92	175.000	30.00
Buses	Diesel	Urban Buses	Euro I	1 392.47	175.000	12.00
Buses	Diesel	Urban Buses	Euro II	1 321.69	113.750	12.00
Buses	Diesel	Urban Buses	Euro III	1 357.54	103.250	6.00
Buses	Diesel	Urban Buses	Euro IV	1 193.76	5.250	12.80
Buses	Diesel	Urban Buses	Euro V	1 212.89	5.250	33.20
Buses	Diesel	Urban Buses	Euro VI A/B/C	1 261.48	5.250	41.50
Buses	Diesel	Urban Buses	Euro VI D/E	1 268.42	5.250	41.50
Buses	Diesel	Coaches	Conventional	684.42	75.287	30.00
Buses	Diesel	Coaches	Euro I	648.18	75.287	8.06
Buses	Diesel	Coaches	Euro II	652.47	48.936	7.59
Buses	Diesel	Coaches	Euro III	658.42	44.419	4.53
Buses	Diesel	Coaches	Euro IV	657.65	2.259	12.67
Buses	Diesel	Coaches	Euro V	692.92	2.259	37.09
Buses	Diesel	Coaches	Euro VI A/B/C	700.34	2.259	34.29



National Inventory Report – Portugal



Category	Fuel	Segment	Euro Standard	CO2 fossil g/km	CH4 mg/km	N2O mg/km
Buses	Diesel	Coaches	Euro VI D/E	701.36	2.259	34.29
Buses	CNG	Urban CNG Buses	Euro I	1 525.19	6 800.000	1 000.00
Buses	CNG	Urban CNG Buses	Euro III	1 250.86	1 280.000	1 000.00
Buses	CNG	Urban CNG Buses	EEV	1 344.60	980.000	1 000.00
L-Category	Petrol	Mopeds 2-stroke <50 cm ³	Conventional	81.27	219.000	1.00
L-Category	Petrol	Mopeds 2-stroke <50 cm ³	Euro 1	65.65	43.800	1.00
L-Category	Petrol	Mopeds 2-stroke <50 cm ³	Euro 2	65.65	24.090	1.00
L-Category	Petrol	Mopeds 2-stroke <50 cm ³	Euro 3	65.65	19.710	1.00
L-Category	Petrol	Mopeds 2-stroke <50 cm ³	Euro 4	65.65	19.710	1.00
L-Category	Petrol	Mopeds 2-stroke <50 cm ³	Euro 5	65.65	19.710	1.00
L-Category	Petrol	Mopeds 4-stroke <50 cm ³	Conventional	81.27	219.000	1.00
L-Category	Petrol	Mopeds 4-stroke <50 cm ³	Euro 1	65.65	43.800	1.00
L-Category	Petrol	Mopeds 4-stroke <50 cm ³	Euro 2	65.65	24.090	1.00
L-Category	Petrol	Mopeds 4-stroke <50 cm ³	Euro 3	55.07	19.710	1.00
L-Category	Petrol	Mopeds 4-stroke <50 cm ³	Euro 4	53.98	19.710	1.00
L-Category	Petrol	Mopeds 4-stroke <50 cm ³	Euro 5	53.98	19.710	1.00
L-Category	Petrol	Motorcycles 2-stroke >50 cm ³	Conventional	109.43	150.000	2.00
L-Category	Petrol	Motorcycles 2-stroke >50 cm ³	Euro 1	101.23	100.373	2.00
L-Category	Petrol	Motorcycles 2-stroke >50 cm ³	Euro 2	101.23	30.365	2.00
L-Category	Petrol	Motorcycles 2-stroke >50 cm ³	Euro 3	65.46	12.365	2.00
L-Category	Petrol	Motorcycles 2-stroke >50 cm ³	Euro 4	67.79	12.365	2.00
L-Category	Petrol	Motorcycles 2-stroke >50 cm ³	Euro 5	67.79	12.365	2.00
L-Category	Petrol	Motorcycles 4-stroke <250 cm ³	Conventional	104.64	200.000	2.00
L-Category	Petrol	Motorcycles 4-stroke <250 cm ³	Euro 1	86.04	139.477	2.00
L-Category	Petrol	Motorcycles 4-stroke <250 cm ³	Euro 2	71.59	112.059	2.00
L-Category	Petrol	Motorcycles 4-stroke <250 cm ³	Euro 3	62.51	53.590	2.00
L-Category	Petrol	Motorcycles 4-stroke <250 cm ³	Euro 4	71.00	53.590	2.00
L-Category	Petrol	Motorcycles 4-stroke <250 cm ³	Euro 5	71.00	53.590	2.00
L-Category	Petrol	Motorcycles 4-stroke 250 - 750 cm ³	Conventional	143.47	200.000	2.00
L-Category	Petrol	Motorcycles 4-stroke 250 - 750 cm ³	Euro 1	136.34	156.731	2.00
L-Category	Petrol	Motorcycles 4-stroke 250 - 750 cm ³	Euro 2	125.12	137.014	2.00
L-Category	Petrol	Motorcycles 4-stroke 250 - 750 cm ³	Euro 3	177.13	63.900	2.00
L-Category	Petrol	Motorcycles 4-stroke 250 - 750 cm ³	Euro 4	148.69	63.900	2.00
L-Category	Petrol	Motorcycles 4-stroke 250 - 750 cm ³	Euro 5	148.69	63.900	2.00
L-Category	Petrol	Motorcycles 4-stroke >750 cm ³	Conventional	163.80	200.000	2.00
L-Category	Petrol	Motorcycles 4-stroke >750 cm ³	Euro 1	153.82	110.657	2.00
L-Category	Petrol	Motorcycles 4-stroke >750 cm ³	Euro 2	153.75	84.066	2.00
L-Category	Petrol	Motorcycles 4-stroke >750 cm ³	Euro 3	176.84	37.172	2.00
L-Category	Petrol	Motorcycles 4-stroke >750 cm ³	Euro 4	148.73	37.172	2.00
L-Category	Petrol	Motorcycles 4-stroke >750 cm ³	Euro 5	148.73	37.172	2.00

**Table B-5: Fuel and lubricant consumption from road transport sector (TJ)**

Fuel	1990	1991	1992	1993	1994	1995	1996	1997	1998	1999	2000
Diesel*	75 778.03	79 322.06	83 290.83	85 747.79	92 121.05	97 235.69	105 415.48	112 872.10	127 740.58	138 050.34	160 136.37
Petrol**	61 131.89	67 292.71	75 053.58	79 027.71	81 635.79	84 280.67	86 727.50	87 424.17	90 989.75	91 945.40	92 733.15
CNG	0.00	0.00	0.00	0.00	0.00	0.00	0.00	0.00	0.00	0.00	29.78
LPG	0.98	2.56	4.51	5.03	5.40	13.28	82.77	796.75	910.55	1 097.65	1 027.14
Lubricants 2-stroke	74.00	69.02	63.91	58.09	52.45	48.08	44.03	40.06	37.51	34.16	31.08
Lubricants 4-stroke	279.29	293.10	313.09	323.29	337.26	348.34	365.55	377.75	405.05	420.12	452.67

Fuel	2001	2002	2003	2004	2005	2006	2007	2008	2009	2010	2011
Diesel*	169 398.15	171 651.80	173 177.29	175 597.29	176 673.02	185 226.47	186 797.14	186 665.76	190 450.08	194 527.94	182 938.79
Petrol**	88 217.65	92 096.09	89 286.60	85 921.39	80 634.46	74 586.03	69 599.90	65 277.90	64 029.05	60 751.90	54 696.56
CNG	197.04	304.13	397.29	391.52	440.00	437.06	483.91	505.81	502.58	526.74	528.29
LPG	996.03	975.81	942.26	867.96	963.02	1 028.40	1 068.05	1 189.80	1 394.20	1 331.70	1 385.83
Lubricants 2-stroke	26.04	25.49	22.48	20.72	19.56	18.92	18.58	17.70	18.67	19.88	18.88
Lubricants 4-stroke	452.67	466.60	463.79	465.99	463.26	470.81	467.30	462.99	473.58	477.75	446.70

Fuel	2012	2013	2014	2015	2016	2017	2018	2019	2020	2021
Diesel*	167 871.09	164 487.36	168 842.84	173 023.45	177 089.50	181 287.35	183 537.84	188 589.09	160 872.98	173 807.88
Petrol**	49 789.07	48 030.82	48 013.34	47 473.13	46 243.71	45 359.67	45 073.09	46 694.92	38 762.34	42 643.50
CNG	503.17	520.13	508.32	548.05	496.72	616.92	672.94	733.02	841.34	996.58
LPG	1 465.38	1 537.39	1 541.87	1 647.00	1 720.61	1 700.22	1 668.86	1 710.39	1 289.37	1 451.27
Lubricants 2-stroke	17.60	17.78	18.07	18.70	20.65	20.73	21.08	22.35	20.15	21.97
Lubricants 4-stroke	413.33	407.44	417.21	424.78	430.23	436.80	440.30	453.18	384.56	415.56

* includes incorporation of Biodiesel

** includes incorporation of Bioethanol



National Inventory Report – Portugal



Table B-6: Vehicle fleet

Category	Fuel	Segment	Euro Standard	1990	1995	2000	2005	2010	2015	2019	2020	2021
Passenger Cars	Petrol	Mini	Euro 4	0	0	0	0	32 145	29 767	30 676	30 563	31 144
Passenger Cars	Petrol	Mini	Euro 5	0	0	0	0	0	20 992	17 375	17 813	18 290
Passenger Cars	Petrol	Mini	Euro 6 a/b/c	0	0	0	0	0	11 646	48 662	42 537	35 245
Passenger Cars	Petrol	Mini	Euro 6 d-temp	0	0	0	0	0	0	18 260	23 887	23 858
Passenger Cars	Petrol	Mini	Euro 6 d	0.0	0.0	0.0	0.0	0.0	0.0	0.0	0.0	5 718.0
Passenger Cars	Petrol	Small	PRE ECE - ECE 15/04	1 314 342	1 510 432	1 147 073	678 906	381 268	233 461	162 932	121 554	116 006
Passenger Cars	Petrol	Small	Euro 1	0	544 032	695 574	555 115	427 631	303 928	208 270	168 994	156 112
Passenger Cars	Petrol	Small	Euro 2	0	0	574 509	510 073	478 939	417 071	336 759	251 758	239 629
Passenger Cars	Petrol	Small	Euro 3	0	0	0	364 643	336 001	327 523	305 966	266 156	262 896
Passenger Cars	Petrol	Small	Euro 4	0	0	0	0	174 241	159 967	159 689	157 782	158 878
Passenger Cars	Petrol	Small	Euro 5	0	0	0	0	0	82 554	70 645	71 190	72 122
Passenger Cars	Petrol	Small	Euro 6 a/b/c	0	0	0	0	0	35 274	178 038	164 975	148 998
Passenger Cars	Petrol	Small	Euro 6 d-temp	0	0	0	0	0	0	64 875	107 678	107 462
Passenger Cars	Petrol	Small	Euro 6 d	0.0	0.0	0.0	0.0	0.0	0.0	0.0	0.0	43 127.0
Passenger Cars	Petrol	Medium	PRE ECE - ECE 15/04	49 005	55 651	41 937	25 475	17 040	11 835	8 797	7 906	7 721
Passenger Cars	Petrol	Medium	Euro 1	0	42 397	66 756	72 893	57 398	40 698	29 110	25 646	24 243
Passenger Cars	Petrol	Medium	Euro 2	0	0	185 430	167 393	160 952	141 023	115 583	105 243	101 080
Passenger Cars	Petrol	Medium	Euro 3	0	0	0	180 661	167 216	163 184	152 327	145 679	144 350
Passenger Cars	Petrol	Medium	Euro 4	0	0	0	0	89 578	82 307	82 558	81 630	82 178
Passenger Cars	Petrol	Medium	Euro 5	0	0	0	0	0	19 221	25 632	26 113	26 746
Passenger Cars	Petrol	Medium	Euro 6 a/b/c	0	0	0	0	0	4 863	43 343	53 820	67 728
Passenger Cars	Petrol	Medium	Euro 6 d-temp	0	0	0	0	0	0	24 941	39 050	38 855
Passenger Cars	Petrol	Medium	Euro 6 d	0.0	0.0	0.0	0.0	0.0	0.0	0.0	0.0	14 109.0
Passenger Cars	Petrol	Large-SUV-Executive	PRE ECE - ECE 15/04	91 320	76 145	48 942	24 497	20 759	17 246	13 570	13 466	13 375
Passenger Cars	Petrol	Large-SUV-Executive	Euro 1	0	17 144	21 751	17 101	14 858	11 861	9 695	9 324	9 323
Passenger Cars	Petrol	Large-SUV-Executive	Euro 2	0	0	26 680	28 162	29 249	26 723	23 933	22 778	22 949
Passenger Cars	Petrol	Large-SUV-Executive	Euro 3	0	0	0	16 474	16 639	16 853	16 154	15 549	15 834
Passenger Cars	Petrol	Large-SUV-Executive	Euro 4	0	0	0	0	7 206	6 153	7 850	7 790	8 263
Passenger Cars	Petrol	Large-SUV-Executive	Euro 5	0	0	0	0	0	4 003	2 893	3 143	3 380
Passenger Cars	Petrol	Large-SUV-Executive	Euro 6 a/b/c	0	0	0	0	0	1 419	7 101	6 177	6 472
Passenger Cars	Petrol	Large-SUV-Executive	Euro 6 d-temp	0	0	0	0	0	0	2 049	3 317	3 310
Passenger Cars	Petrol	Large-SUV-Executive	Euro 6 d	0.0	0.0	0.0	0.0	0.0	0.0	0.0	0.0	1 278.0
Passenger Cars	Petrol Hybrid	All Segments	Euro 4	0	0	0	1 227	7 601	7 699	7 711	7 567	7 643
Passenger Cars	Petrol Hybrid	All Segments	Euro 5	0	0	0	0	0	6 682	10 956	11 954	12 343
Passenger Cars	Petrol Hybrid	All Segments	Euro 6 a/b/c	0	0	0	0	0	4 088	26 876	27 604	28 331
Passenger Cars	Petrol Hybrid	All Segments	Euro 6 d-temp	0	0	0	0	0	0	13 181	35 873	35 873
Passenger Cars	Petrol Hybrid	All Segments	Euro 6 d	0.0	0.0	0.0	0.0	0.0	0.0	0.0	0.0	22 692.0
Passenger Cars	Diesel	Mini	Euro 4	0	0	0	0	6 055	6 282	7 926	8 176	8 404
Passenger Cars	Diesel	Mini	Euro 5	0	0	0	0	0	2 571	3 478	3 641	3 936
Passenger Cars	Diesel	Mini	Euro 6 a/b/c	0	0	0	0	0	0	1 215	1 215	1 215
Passenger Cars	Diesel	Mini	Euro 6 d-temp	0	0	0	0	0	0	10	10	10
Passenger Cars	Diesel	Small	Conventional	31 145	52 304	50 885	43 369	29 400	19 428	13 077	10 837	10 064
Passenger Cars	Diesel	Small	Euro 1	0	33 346	43 841	42 456	34 746	28 085	22 032	19 927	18 846
Passenger Cars	Diesel	Small	Euro 2	0	0	37 486	37 250	35 885	33 745	30 548	29 102	28 571
Passenger Cars	Diesel	Small	Euro 3	0	0	0	71 323	71 133	72 403	70 077	68 067	67 923
Passenger Cars	Diesel	Small	Euro 4	0	0	0	0	50 792	51 113	53 835	53 663	54 437
Passenger Cars	Diesel	Small	Euro 5	0	0	0	0	0	24 667	29 157	30 072	30 719
Passenger Cars	Diesel	Small	Euro 6 a/b/c	0	0	0	0	0	5 889	41 414	41 609	41 803



National Inventory Report – Portugal



Category	Fuel	Segment	Euro Standard	1990	1995	2000	2005	2010	2015	2019	2020	2021
Passenger Cars	Diesel	Small	Euro 6 d-temp	0	0	0	0	0	0	14 590	21 890	21 890
Passenger Cars	Diesel	Small	Euro 6 d	0.0	0.0	0.0	0.0	0.0	0.0	0.0	0.0	7 300.0
Passenger Cars	Diesel	Medium	Conventional	9 902	26 450	26 190	24 159	18 657	12 999	8 669	7 440	6 824
Passenger Cars	Diesel	Medium	Euro 1	0	49 845	72 530	74 093	68 423	58 530	46 801	42 311	40 193
Passenger Cars	Diesel	Medium	Euro 2	0	0	144 097	143 182	144 836	137 124	124 804	118 534	116 362
Passenger Cars	Diesel	Medium	Euro 3	0	0	0	285 107	283 682	280 755	268 890	261 511	260 747
Passenger Cars	Diesel	Medium	Euro 4	0	0	0	0	388 526	389 210	391 130	386 220	388 772
Passenger Cars	Diesel	Medium	Euro 5	0	0	0	0	0	247 219	299 230	310 544	315 522
Passenger Cars	Diesel	Medium	Euro 6 a/b/c	0	0	0	0	0	95 659	351 997	361 957	371 917
Passenger Cars	Diesel	Medium	Euro 6 d-temp	0	0	0	0	0	0	57 512	89 456	89 456
Passenger Cars	Diesel	Medium	Euro 6 d	0.0	0.0	0.0	0.0	0.0	0.0	0.0	0.0	31 944.0
Passenger Cars	Diesel	Large-SUV-Executive	Conventional	57 173	70 532	65 192	57 821	50 984	43 722	37 413	35 003	34 454
Passenger Cars	Diesel	Large-SUV-Executive	Euro 1	0	37 787	65 106	67 426	64 727	57 454	49 676	46 680	45 856
Passenger Cars	Diesel	Large-SUV-Executive	Euro 2	0	0	211 246	209 863	209 622	195 252	177 237	168 253	166 893
Passenger Cars	Diesel	Large-SUV-Executive	Euro 3	0	0	0	238 066	236 996	235 335	227 520	221 328	222 223
Passenger Cars	Diesel	Large-SUV-Executive	Euro 4	0	0	0	0	239 424	238 400	250 218	247 082	250 636
Passenger Cars	Diesel	Large-SUV-Executive	Euro 5	0	0	0	0	0	107 912	126 949	129 937	132 863
Passenger Cars	Diesel	Large-SUV-Executive	Euro 6 a/b/c	0	0	0	0	0	31 759	134 162	136 950	139 738
Passenger Cars	Diesel	Large-SUV-Executive	Euro 6 d-temp	0	0	0	0	0	0	17 852	26 068	26 068
Passenger Cars	Diesel	Large-SUV-Executive	Euro 6 d	0.0	0.0	0.0	0.0	0.0	0.0	0.0	0.0	8 216.0
Passenger Cars	LPG Bifuel	All Segments	Conventional	25	164	4 561	4 477	5 671	7 562	8 243	8 243	8 243
Passenger Cars	LPG Bifuel	All Segments	Euro 1	0	186	7 066	6 937	8 788	11 718	12 770	12 770	12 770
Passenger Cars	LPG Bifuel	All Segments	Euro 2	0	0	9 300	9 129	11 566	15 421	16 806	16 806	16 806
Passenger Cars	LPG Bifuel	All Segments	Euro 3	0	0	0	4 753	6 021	8 028	8 750	8 750	8 750
Passenger Cars	LPG Bifuel	All Segments	Euro 4	0	0	0	0	1 592	1 585	1 620	1 620	1 620
Passenger Cars	LPG Bifuel	All Segments	Euro 5	0	0	0	0	0	3 750	4 329	4 329	4 329
Passenger Cars	LPG Bifuel	All Segments	Euro 6 a/b/c	0	0	0	0	0	0	2 725	2 725	2 725
Passenger Cars	LPG Bifuel	All Segments	Euro 6 d-temp	0	0	0	0	0	0	6 706	6 706	6 706
Light Commercial Vehicles	Petrol	N1-I	Conventional	35 580	35 948	30 761	21 038	13 153	9 754	7 791	6 950	6 978
Light Commercial Vehicles	Petrol	N1-I	Euro 1	0	461	919	832	533	322	209	174	152
Light Commercial Vehicles	Petrol	N1-I	Euro 2	0	0	230	214	190	178	125	137	125
Light Commercial Vehicles	Petrol	N1-I	Euro 3	0	0	0	402	480	431	372	356	337
Light Commercial Vehicles	Petrol	N1-I	Euro 4	0	0	0	0	11	13	18	22	22
Light Commercial Vehicles	Petrol	N1-I	Euro 5	0	0	0	0	0	4	10	11	12
Light Commercial Vehicles	Petrol	N1-I	Euro 6 a/b/c	0	0	0	0	0	0	6	9	9
Light Commercial Vehicles	Petrol	N1-I	Euro 6 d-temp	0	0	0	0	0	0	67	132	133
Light Commercial Vehicles	Petrol	N1-II & N1-III	Conventional	2 219	2 731	2 435	2 000	1 609	1 422	1 216	1 209	1 276
Light Commercial Vehicles	Petrol	N1-II & N1-III	Euro 1	0	38	110	89	151	121	102	92	96
Light Commercial Vehicles	Petrol	N1-II & N1-III	Euro 2	0	0	31	232	276	264	229	222	221
Light Commercial Vehicles	Petrol	N1-II & N1-III	Euro 3	0	0	0	25	57	67	72	74	76
Light Commercial Vehicles	Petrol	N1-II & N1-III	Euro 4	0	0	0	0	4	13	31	27	30
Light Commercial Vehicles	Petrol	N1-II & N1-III	Euro 5	0	0	0	0	0	1	6	8	18
Light Commercial Vehicles	Petrol	N1-II & N1-III	Euro 6 a/b/c	0	0	0	0	0	0	4	6	9
Light Commercial Vehicles	Petrol	N1-II & N1-III	Euro 6 d-temp	0	0	0	0	0	0	2	3	9
Light Commercial Vehicles	Diesel	N1-I	Conventional	46 471	161 742	160 307	141 339	97 499	65 074	43 927	38 400	35 649
Light Commercial Vehicles	Diesel	N1-I	Euro 1	0	28 452	107 939	104 661	89 788	73 461	56 930	51 569	48 808
Light Commercial Vehicles	Diesel	N1-I	Euro 2	0	0	143 654	142 123	132 054	118 382	101 958	95 766	93 007
Light Commercial Vehicles	Diesel	N1-I	Euro 3	0	0	0	162 955	167 534	157 942	145 646	140 055	138 654
Light Commercial Vehicles	Diesel	N1-I	Euro 4	0	0	0	0	103 686	105 451	101 449	99 106	99 322
Light Commercial Vehicles	Diesel	N1-I	Euro 5	0	0	0	0	0	24 562	25 118	24 769	25 176
Light Commercial Vehicles	Diesel	N1-I	Euro 6 a/b/c	0	0	0	0	0	5 651	14 593	14 652	15 075
Light Commercial Vehicles	Diesel	N1-I	Euro 6 d-temp	0	0	0	0	0	0	6 402	6 930	7 273



National Inventory Report – Portugal



Category	Fuel	Segment	Euro Standard	1990	1995	2000	2005	2010	2015	2019	2020	2021
Light Commercial Vehicles	Diesel	N1-I	Euro 6 d	0.0	0.0	0.0	0.0	0.0	0.0	0.0	0.0	540.0
Light Commercial Vehicles	Diesel	N1-II & N1-III	Conventional	206 191	344 266	327 430	278 575	215 732	171 559	149 929	142 347	141 864
Light Commercial Vehicles	Diesel	N1-II & N1-III	Euro 1	0	18 185	104 999	101 499	92 045	79 823	73 060	69 970	70 036
Light Commercial Vehicles	Diesel	N1-II & N1-III	Euro 2	0	0	81 309	117 418	109 705	99 062	92 737	89 845	90 072
Light Commercial Vehicles	Diesel	N1-II & N1-III	Euro 3	0	0	0	104 492	133 051	123 906	117 989	114 960	115 556
Light Commercial Vehicles	Diesel	N1-II & N1-III	Euro 4	0	0	0	0	97 479	117 396	115 188	113 480	115 564
Light Commercial Vehicles	Diesel	N1-II & N1-III	Euro 5	0	0	0	0	0	36 262	39 526	40 528	41 972
Light Commercial Vehicles	Diesel	N1-II & N1-III	Euro 6 a/b/c	0	0	0	0	0	19 182	70 193	72 021	75 109
Light Commercial Vehicles	Diesel	N1-II & N1-III	Euro 6 d-temp	0	0	0	0	0	0	56 032	83 709	86 526
Light Commercial Vehicles	Diesel	N1-II & N1-III	Euro 6 d	0.0	0.0	0.0	0.0	0.0	0.0	0.0	0.0	27 822.0
Heavy Duty Trucks	Diesel	<=20 t	Conventional	33 568	43 785	40 420	31 480	19 438	11 275	8 609	7 774	7 666
Heavy Duty Trucks	Diesel	<=20 t	Euro I	0	4 239	6 243	6 151	5 165	3 752	3 160	2 877	2 846
Heavy Duty Trucks	Diesel	<=20 t	Euro II	0	0	13 333	16 183	16 090	12 678	11 853	11 036	10 949
Heavy Duty Trucks	Diesel	<=20 t	Euro III	0	0	0	7 035	12 220	13 128	14 296	13 348	13 389
Heavy Duty Trucks	Diesel	<=20 t	Euro IV	0	0	0	0	11 343	11 241	11 414	11 007	11 138
Heavy Duty Trucks	Diesel	<=20 t	Euro V	0	0	0	0	2 702	9 139	10 620	10 692	10 842
Heavy Duty Trucks	Diesel	<=20 t	Euro VI A/B/C	0	0	0	0	0	7 287	19 869	19 452	19 507
Heavy Duty Trucks	Diesel	<=20 t	Euro VI D/E	0	0	0	0	0	0	4 215	8 410	12 624
Heavy Duty Trucks	Diesel	20 - 28 t	Conventional	8 891	11 108	10 189	7 840	4 246	2 198	1 549	1 375	1 287
Heavy Duty Trucks	Diesel	20 - 28 t	Euro I	0	989	1 523	1 538	1 236	823	671	632	598
Heavy Duty Trucks	Diesel	20 - 28 t	Euro II	0	0	3 451	4 258	4 040	3 124	2 783	2 694	2 645
Heavy Duty Trucks	Diesel	20 - 28 t	Euro III	0	0	0	1 401	1 919	2 087	2 377	2 395	2 482
Heavy Duty Trucks	Diesel	20 - 28 t	Euro IV	0	0	0	0	815	876	1 179	1 243	1 338
Heavy Duty Trucks	Diesel	20 - 28 t	Euro V	0	0	0	0	168	462	770	831	940
Heavy Duty Trucks	Diesel	20 - 28 t	Euro VI A/B/C	0	0	0	0	0	183	755	806	900
Heavy Duty Trucks	Diesel	20 - 28 t	Euro VI D/E	0	0	0	0	0	0	221	441	661
Heavy Duty Trucks	Diesel	>28 t	Conventional	9 595	15 044	13 400	8 321	3 000	1 014	525	451	386
Heavy Duty Trucks	Diesel	>28 t	Euro I	0	3 911	6 194	5 752	2 985	1 248	721	617	557
Heavy Duty Trucks	Diesel	>28 t	Euro II	0	0	14 171	17 551	12 378	6 098	2 943	2 614	2 357
Heavy Duty Trucks	Diesel	>28 t	Euro III	0	0	0	8 007	8 529	5 942	2 475	2 213	2 102
Heavy Duty Trucks	Diesel	>28 t	Euro IV	0	0	0	0	1 088	644	729	773	824
Heavy Duty Trucks	Diesel	>28 t	Euro V	0	0	0	0	90	137	194	216	249
Heavy Duty Trucks	Diesel	>28 t	Euro VI A/B/C	0	0	0	0	0	77	505	534	557
Heavy Duty Trucks	Diesel	>28 t	Euro VI D/E	0	0	0	0	0	0	198	395	592
Buses	Diesel	Urban Buses	Conventional	5 458	6 603	6 238	5 265	2 875	1 351	702	509	449
Buses	Diesel	Urban Buses	Euro I	0	806	1 299	1 233	1 422	1 012	541	418	368
Buses	Diesel	Urban Buses	Euro II	0	0	2 991	3 515	3 650	3 477	2 729	2 315	2 056
Buses	Diesel	Urban Buses	Euro III	0	0	0	2 231	2 898	3 377	3 657	3 352	3 177
Buses	Diesel	Urban Buses	Euro IV	0	0	0	0	1 698	1 840	2 389	2 300	2 320
Buses	Diesel	Urban Buses	Euro V	0	0	0	0	395	1 084	1 297	1 315	1 415
Buses	Diesel	Urban Buses	Euro VI A/B/C	0	0	0	0	0	433	1 621	1 614	1 679
Buses	Diesel	Urban Buses	Euro VI D/E	0	0	0	0	0	0	344	598	890
Buses	Diesel	Coaches	Conventional	751	898	847	719	429	203	101	75	67
Buses	Diesel	Coaches	Euro I	0	98	168	170	221	170	90	69	61
Buses	Diesel	Coaches	Euro II	0	0	402	460	491	499	403	341	299
Buses	Diesel	Coaches	Euro III	0	0	0	214	270	364	458	429	417
Buses	Diesel	Coaches	Euro IV	0	0	0	0	136	154	248	245	250
Buses	Diesel	Coaches	Euro V	0	0	0	0	38	108	143	148	166
Buses	Diesel	Coaches	Euro VI A/B/C	0	0	0	0	0	42	149	147	152
Buses	Diesel	Coaches	Euro VI D/E	0.0	0.0	0.0	0.0	0.0	0.0	32.0	57.0	84.0
Buses	CNG	Urban CNG Buses	Euro I	0	0	0	0	0	1	1	1	1
Buses	CNG	Urban CNG Buses	Euro II	0	0	1	23	23	16	0	0	0



National Inventory Report – Portugal



Category	Fuel	Segment	Euro Standard	1990	1995	2000	2005	2010	2015	2019	2020	2021
Buses	CNG	Urban CNG Buses	Euro III	0	0	0	21	30	35	36	28	22
Buses	CNG	Urban CNG Buses	EEV	0	0	0	0	90	89	416	503	518
L-Category	Petrol	Mopeds 2-stroke <50 cm ³	Conventional	417 346	341 022	264 699	140 866	100 710	92 770	88 863	91 027	94 785
L-Category	Petrol	Mopeds 2-stroke <50 cm ³	Euro 1	0	0	0	9 163	7 145	5 651	4 328	3 997	3 634
L-Category	Petrol	Mopeds 2-stroke <50 cm ³	Euro 2	0	0	0	15 238	15 911	11 368	9 423	8 882	8 663
L-Category	Petrol	Mopeds 2-stroke <50 cm ³	Euro 3	0	0	0	0	17 922	26 070	26 632	24 215	20 842
L-Category	Petrol	Mopeds 2-stroke <50 cm ³	Euro 4	0	0	0	0	0	0	2 756	3 575	3 369
L-Category	Petrol	Mopeds 2-stroke <50 cm ³	Euro 5	0.0	0.0	0.0	0.0	0.0	0.0	0.0	0.0	1 089.0
L-Category	Petrol	Mopeds 4-stroke <50 cm ³	Conventional	417 346	341 022	264 699	140 866	100 710	92 770	88 863	91 027	94 785
L-Category	Petrol	Mopeds 4-stroke <50 cm ³	Euro 1	0	0	0	9 163	7 145	5 651	4 328	3 997	3 634
L-Category	Petrol	Mopeds 4-stroke <50 cm ³	Euro 2	0	0	0	15 238	15 911	11 368	9 423	8 882	8 663
L-Category	Petrol	Mopeds 4-stroke <50 cm ³	Euro 3	0	0	0	0	17 922	26 070	26 632	24 215	20 842
L-Category	Petrol	Mopeds 4-stroke <50 cm ³	Euro 4	0	0	0	0	0	0	2 756	3 575	3 369
L-Category	Petrol	Mopeds 4-stroke <50 cm ³	Euro 5	0.0	0.0	0.0	0.0	0.0	0.0	0.0	0.0	1 089.0
L-Category	Petrol	Motorcycles 2-stroke >50 cm ³	Conventional	14 753	20 578	31 798	14 218	29 622	28 748	31 363	31 658	32 437
L-Category	Petrol	Motorcycles 2-stroke >50 cm ³	Euro 1	0	0	0	10 200	14 985	14 535	18 439	17 893	17 691
L-Category	Petrol	Motorcycles 2-stroke >50 cm ³	Euro 2	0	0	0	6 158	12 526	12 961	17 102	16 731	16 012
L-Category	Petrol	Motorcycles 2-stroke >50 cm ³	Euro 3	0	0	0	0	20 774	56 563	74 752	76 261	76 322
L-Category	Petrol	Motorcycles 2-stroke >50 cm ³	Euro 4	0	0	0	0	0	0	37 006	50 302	50 503
L-Category	Petrol	Motorcycles 2-stroke >50 cm ³	Euro 5	0.0	0.0	0.0	0.0	0.0	0.0	0.0	0.0	14 961.0
L-Category	Petrol	Motorcycles 4-stroke <250 cm ³	Conventional	7 869	10 975	17 591	9 473	8 375	5 565	5 600	5 652	5 791
L-Category	Petrol	Motorcycles 4-stroke <250 cm ³	Euro 1	0	0	0	6 796	4 237	2 814	3 292	3 195	3 159
L-Category	Petrol	Motorcycles 4-stroke <250 cm ³	Euro 2	0	0	0	4 103	3 541	2 509	3 053	2 987	2 859
L-Category	Petrol	Motorcycles 4-stroke <250 cm ³	Euro 3	0	0	0	0	5 873	10 950	13 347	13 616	13 627
L-Category	Petrol	Motorcycles 4-stroke <250 cm ³	Euro 4	0	0	0	0	0	0	6 607	8 981	9 017
L-Category	Petrol	Motorcycles 4-stroke <250 cm ³	Euro 5	0.0	0.0	0.0	0.0	0.0	0.0	0.0	0.0	2 671.0
L-Category	Petrol	Motorcycles 4-stroke 250 - 750 cm ³	Conventional	26 481	36 936	54 811	27 567	22 198	14 564	14 879	15 019	15 388
L-Category	Petrol	Motorcycles 4-stroke 250 - 750 cm ³	Euro 1	0	0	0	19 777	11 229	7 364	8 748	8 489	8 393
L-Category	Petrol	Motorcycles 4-stroke 250 - 750 cm ³	Euro 2	0	0	0	11 940	9 387	6 566	8 113	7 937	7 596
L-Category	Petrol	Motorcycles 4-stroke 250 - 750 cm ³	Euro 3	0	0	0	0	15 567	28 656	35 464	36 179	36 208
L-Category	Petrol	Motorcycles 4-stroke 250 - 750 cm ³	Euro 4	0	0	0	0	0	0	17 556	23 864	23 959
L-Category	Petrol	Motorcycles 4-stroke 250 - 750 cm ³	Euro 5	0.0	0.0	0.0	0.0	0.0	0.0	0.0	0.0	7 098.0
L-Category	Petrol	Motorcycles 4-stroke >750 cm ³	Conventional	17 027	23 749	40 396	21 773	21 039	16 289	17 789	17 956	18 398
L-Category	Petrol	Motorcycles 4-stroke >750 cm ³	Euro 1	0	0	0	15 620	10 643	8 236	10 459	10 149	10 034
L-Category	Petrol	Motorcycles 4-stroke >750 cm ³	Euro 2	0	0	0	9 430	8 897	7 344	9 700	9 490	9 082
L-Category	Petrol	Motorcycles 4-stroke >750 cm ³	Euro 3	0	0	0	0	14 755	32 049	42 399	43 255	43 289
L-Category	Petrol	Motorcycles 4-stroke >750 cm ³	Euro 4	0	0	0	0	0	0	20 990	28 531	28 645
L-Category	Petrol	Motorcycles 4-stroke >750 cm ³	Euro 5	0.0	0.0	0.0	0.0	0.0	0.0	0.0	0.0	8 486.0



National Inventory Report – Portugal



Table B-7: Total activity (vkm)

Category	Fuel	Segment	Euro Standard	1990	1995	2000	2005	2010	2015	2019	2020	2021
Passenger Cars	Petrol	Mini	Euro 4	0	0	0	0	228 173 413	219 635 990	208 382 889	176 325 934	188 655 333
Passenger Cars	Petrol	Mini	Euro 5	0	0	0	0	0	88 637 867	118 939 596	106 790 145	114 253 919
Passenger Cars	Petrol	Mini	Euro 6 a/b/c	0	0	0	0	0	71 291 757	275 590 145	209 360 284	199 009 226
Passenger Cars	Petrol	Mini	Euro 6 d-temp	0	0	0	0	0	0	163 501 055	184 630 696	229 361 586
Passenger Cars	Petrol	Mini	Euro 6 d	0.0	0.0	0.0	0.0	0.0	0.0	0.0	0.0	47 409 412.5
Passenger Cars	Petrol	Small	PRE ECE - ECE 15/04	17 125 833 850	18 395 761 856	11 320 359 994	5 370 810 690	2 217 574 229	1 034 108 450	587 123 976	373 307 065	367 285 657
Passenger Cars	Petrol	Small	Euro 1	0	8 147 241 831	9 118 322 556	5 965 152 451	3 567 910 871	2 035 902 333	1 178 425 603	802 446 122	771 864 430
Passenger Cars	Petrol	Small	Euro 2	0	0	7 429 277 088	6 008 906 309	4 479 117 684	3 165 733 973	2 201 874 758	1 387 795 792	1 378 561 137
Passenger Cars	Petrol	Small	Euro 3	0	0	0	4 259 638 143	3 346 988 852	2 712 125 013	2 210 563 388	1 628 083 775	1 681 553 233
Passenger Cars	Petrol	Small	Euro 4	0	0	0	0	1 267 747 175	1 286 213 282	1 181 185 877	993 790 522	1 044 564 341
Passenger Cars	Petrol	Small	Euro 5	0	0	0	0	0	491 085 446	526 599 453	460 679 272	483 700 393
Passenger Cars	Petrol	Small	Euro 6 a/b/c	0	0	0	0	0	258 223 056	1 445 875 207	1 225 598 021	1 031 342 038
Passenger Cars	Petrol	Small	Euro 6 d-temp	0	0	0	0	0	0	727 757 998	1 042 699 364	1 256 686 539
Passenger Cars	Petrol	Small	Euro 6 d	0.0	0.0	0.0	0.0	0.0	0.0	0.0	0.0	447 980 904.6
Passenger Cars	Petrol	Medium	PRE ECE - ECE 15/04	647 706 668	801 083 548	523 571 608	256 187 797	121 484 573	62 062 421	37 793 890	28 152 272	28 343 926
Passenger Cars	Petrol	Medium	Euro 1	0	483 101 517	968 506 976	882 801 703	534 810 270	301 037 175	182 259 312	134 916 554	132 750 332
Passenger Cars	Petrol	Medium	Euro 2	0	0	2 163 401 075	2 314 946 329	1 739 493 843	1 237 777 319	874 070 783	669 591 783	671 854 923
Passenger Cars	Petrol	Medium	Euro 3	0	0	0	2 042 395 419	1 829 328 927	1 467 720 651	1 202 794 036	973 123 311	1 006 904 363
Passenger Cars	Petrol	Medium	Euro 4	0	0	0	0	660 945 790	677 189 652	617 047 557	519 098 098	547 100 548
Passenger Cars	Petrol	Medium	Euro 5	0	0	0	0	0	124 589 037	192 509 976	167 665 347	178 833 233
Passenger Cars	Petrol	Medium	Euro 6 a/b/c	0	0	0	0	0	34 567 305	366 512 535	400 148 954	471 426 755
Passenger Cars	Petrol	Medium	Euro 6 d-temp	0	0	0	0	0	0	204 826 167	276 831 257	334 997 083
Passenger Cars	Petrol	Medium	Euro 6 d	0.0	0.0	0.0	0.0	0.0	0.0	0.0	0.0	107 292 272.9
Passenger Cars	Petrol	Large-SUV-Executive	PRE ECE - ECE 15/04	1 435 416 132	1 107 301 978	593 101 256	224 585 265	129 611 233	77 287 495	51 771 081	40 038 578	42 484 739
Passenger Cars	Petrol	Large-SUV-Executive	Euro 1	0	309 174 864	375 180 809	233 710 569	144 117 610	86 734 058	58 219 308	45 683 442	49 012 301
Passenger Cars	Petrol	Large-SUV-Executive	Euro 2	0	0	439 852 547	430 767 432	319 404 030	223 019 353	172 179 693	135 247 371	146 757 725
Passenger Cars	Petrol	Large-SUV-Executive	Euro 3	0	0	0	239 472 382	193 251 343	147 535 630	120 275 309	96 569 282	107 414 431
Passenger Cars	Petrol	Large-SUV-Executive	Euro 4	0	0	0	0	58 377 949	51 113 954	56 647 270	47 349 106	55 903 367
Passenger Cars	Petrol	Large-SUV-Executive	Euro 5	0	0	0	0	0	22 576 608	21 255 164	19 633 301	24 863 163
Passenger Cars	Petrol	Large-SUV-Executive	Euro 6 a/b/c	0	0	0	0	0	10 714 170	56 860 749	41 631 307	56 659 495
Passenger Cars	Petrol	Large-SUV-Executive	Euro 6 d-temp	0	0	0	0	0	0	11 718 266	16 375 304	33 051 053
Passenger Cars	Petrol	Large-SUV-Executive	Euro 6 d	0.0	0.0	0.0	0.0	0.0	0.0	0.0	0.0	6 767 883.8
Passenger Cars	Petrol Hybrid	All Segments	Euro 4	0	0	0	19 280 077	95 919 042	88 517 793	78 440 069	65 525 995	68 924 789
Passenger Cars	Petrol Hybrid	All Segments	Euro 5	0	0	0	0	0	96 523 883	175 632 265	157 644 985	165 606 734
Passenger Cars	Petrol Hybrid	All Segments	Euro 6 a/b/c	0	0	0	0	0	54 022 714	275 403 295	262 659 595	293 126 645
Passenger Cars	Petrol Hybrid	All Segments	Euro 6 d-temp	0	0	0	0	0	0	121 847 829	286 259 327	312 155 841
Passenger Cars	Petrol Hybrid	All Segments	Euro 6 d	0.0	0.0	0.0	0.0	0.0	0.0	0.0	0.0	194 241 868.9
Passenger Cars	Diesel	Mini	Euro 4	0	0	0	0	53 646 231	62 640 243	71 677 592	61 137 424	70 107 137
Passenger Cars	Diesel	Mini	Euro 5	0	0	0	0	0	20 377 644	33 271 458	28 724 776	35 842 823
Passenger Cars	Diesel	Mini	Euro 6 a/b/c	0	0	0	0	0	0	7 272 843	8 338 628	13 119 732
Passenger Cars	Diesel	Mini	Euro 6 d-temp	0	0	0	0	0	0	59 859	51 173	109 671
Passenger Cars	Diesel	Small	Conventional	749 769 632	751 935 607	639 874 133	428 657 162	264 698 001	136 247 208	83 158 552	58 050 994	56 174 873
Passenger Cars	Diesel	Small	Euro 1	0	656 417 686	815 252 124	581 109 877	435 429 781	276 410 822	200 758 677	151 972 889	150 038 355
Passenger Cars	Diesel	Small	Euro 2	0	0	793 039 282	639 106 611	515 790 626	381 948 394	315 626 881	251 603 801	256 156 536
Passenger Cars	Diesel	Small	Euro 3	0	0	0	1 109 336 668	1 067 001 845	825 384 925	730 953 003	593 469 819	619 094 091
Passenger Cars	Diesel	Small	Euro 4	0	0	0	0	723 736 373	621 769 096	586 122 804	487 779 393	511 714 838
Passenger Cars	Diesel	Small	Euro 5	0	0	0	0	0	331 417 096	460 860 185	375 735 895	380 809 072
Passenger Cars	Diesel	Small	Euro 6 a/b/c	0	0	0	0	0	86 689 468	596 150 187	537 645 625	527 750 300



National Inventory Report – Portugal



Category	Fuel	Segment	Euro Standard	1990	1995	2000	2005	2010	2015	2019	2020	2021
Passenger Cars	Diesel	Small	Euro 6 d-temp	0	0	0	0	0	0	213 194 906	273 449 642	280 478 553
Passenger Cars	Diesel	Small	Euro 6 d	0.0	0.0	0.0	0.0	0.0	0.0	0.0	0.0	97 148 903.7
Passenger Cars	Diesel	Medium	Conventional	231 464 098	465 355 004	413 596 456	302 278 117	211 938 472	111 033 136	64 096 313	45 614 725	42 616 808
Passenger Cars	Diesel	Medium	Euro 1	0	906 179 150	1 363 273 964	1 067 096 808	894 418 191	581 320 675	421 060 645	318 036 088	312 825 278
Passenger Cars	Diesel	Medium	Euro 2	0	0	2 801 855 147	2 480 878 486	2 200 872 580	1 628 063 907	1 373 940 244	1 096 698 706	1 121 033 004
Passenger Cars	Diesel	Medium	Euro 3	0	0	0	4 634 679 417	4 729 685 715	3 564 675 053	3 155 361 201	2 572 331 167	2 662 366 550
Passenger Cars	Diesel	Medium	Euro 4	0	0	0	0	5 561 278 899	5 245 340 653	4 704 659 924	3 876 313 677	4 043 394 423
Passenger Cars	Diesel	Medium	Euro 5	0	0	0	0	0	3 346 070 060	4 601 844 185	3 814 896 572	4 067 727 727
Passenger Cars	Diesel	Medium	Euro 6 a/b/c	0	0	0	0	0	1 228 408 457	4 414 462 332	4 294 274 822	4 648 336 947
Passenger Cars	Diesel	Medium	Euro 6 d-temp	0	0	0	0	0	0	661 748 196	879 941 573	956 030 617
Passenger Cars	Diesel	Medium	Euro 6 d	0.0	0.0	0.0	0.0	0.0	0.0	0.0	0.0	334 747 317.3
Passenger Cars	Diesel	Large-SUV-Executive	Conventional	1 275 652 831	1 249 562 825	1 076 435 402	760 276 391	618 023 805	411 093 224	320 236 697	250 323 914	254 701 723
Passenger Cars	Diesel	Large-SUV-Executive	Euro 1	0	525 297 686	1 486 208 010	1 126 013 665	947 789 336	632 113 471	490 420 614	381 801 356	388 238 238
Passenger Cars	Diesel	Large-SUV-Executive	Euro 2	0	0	3 302 679 244	4 020 260 959	3 191 781 082	2 244 202 869	1 838 603 432	1 450 685 924	1 490 608 824
Passenger Cars	Diesel	Large-SUV-Executive	Euro 3	0	0	0	3 533 745 758	4 444 508 974	3 169 197 140	2 790 227 496	2 273 913 552	2 359 704 607
Passenger Cars	Diesel	Large-SUV-Executive	Euro 4	0	0	0	0	3 234 382 838	3 749 265 357	3 339 387 701	2 746 269 685	2 874 806 070
Passenger Cars	Diesel	Large-SUV-Executive	Euro 5	0	0	0	0	0	1 490 532 696	2 119 927 472	1 728 344 797	1 794 650 883
Passenger Cars	Diesel	Large-SUV-Executive	Euro 6 a/b/c	0	0	0	0	0	272 403 734	1 495 066 371	1 552 554 041	1 738 174 065
Passenger Cars	Diesel	Large-SUV-Executive	Euro 6 d-temp	0	0	0	0	0	0	135 108 150	168 660 136	221 657 403
Passenger Cars	Diesel	Large-SUV-Executive	Euro 6 d	0.0	0.0	0.0	0.0	0.0	0.0	0.0	0.0	56 630 267.3
Passenger Cars	LPG Bifuel	All Segments	Conventional	362 577	1 126 869	31 780 936	23 681 573	26 008 189	28 565 833	25 193 513	25 722 648	24 219 398
Passenger Cars	LPG Bifuel	All Segments	Euro 1	0	3 809 484	172 693 428	123 288 812	129 664 047	151 638 011	135 577 046	97 339 979	107 441 085
Passenger Cars	LPG Bifuel	All Segments	Euro 2	0	0	169 310 734	118 453 061	176 295 946	194 957 482	163 523 964	121 627 421	137 640 975
Passenger Cars	LPG Bifuel	All Segments	Euro 3	0	0	0	76 012 654	105 882 345	114 465 748	90 731 358	66 744 098	74 794 982
Passenger Cars	LPG Bifuel	All Segments	Euro 4	0	0	0	0	28 497 324	24 965 501	19 103 427	13 966 029	15 624 662
Passenger Cars	LPG Bifuel	All Segments	Euro 5	0	0	0	0	0	48 481 518	52 555 664	37 598 598	43 259 241
Passenger Cars	LPG Bifuel	All Segments	Euro 6 a/b/c	0	0	0	0	0	0	28 703 432	23 962 900	28 667 745
Passenger Cars	LPG Bifuel	All Segments	Euro 6 d-temp	0	0	0	0	0	0	64 530 686	50 562 550	60 564 802
Light Commercial Vehicles	Petrol	N1-I	Conventional	554 508 903	405 669 360	245 969 131	123 180 519	53 338 829	29 256 711	19 222 682	14 417 246	14 700 158
Light Commercial Vehicles	Petrol	N1-I	Euro 1	0	10 712 734	15 539 179	10 673 857	5 093 586	2 253 884	1 188 491	852 777	877 351
Light Commercial Vehicles	Petrol	N1-I	Euro 2	0	0	4 564 212	3 058 088	1 995 756	1 430 649	834 350	758 933	732 557
Light Commercial Vehicles	Petrol	N1-I	Euro 3	0	0	0	5 484 147	5 238 703	3 841 352	3 113 894	2 433 272	2 393 558
Light Commercial Vehicles	Petrol	N1-I	Euro 4	0	0	0	0	204 406	142 959	159 123	161 677	170 374
Light Commercial Vehicles	Petrol	N1-I	Euro 5	0	0	0	0	0	37 396	72 470	68 555	81 052
Light Commercial Vehicles	Petrol	N1-I	Euro 6 a/b/c	0	0	0	0	0	0	73 749	88 738	90 176
Light Commercial Vehicles	Petrol	N1-I	Euro 6 d-temp	0	0	0	0	0	0	1 075 489	1 826 043	1 863 712
Light Commercial Vehicles	Petrol	N1-II & N1-III	Conventional	33 743 420	38 956 577	25 457 506	16 481 440	8 515 112	5 070 961	3 552 094	2 832 034	3 081 407
Light Commercial Vehicles	Petrol	N1-II & N1-III	Euro 1	0	802 406	1 902 520	1 021 520	1 453 882	913 475	651 088	452 783	475 946
Light Commercial Vehicles	Petrol	N1-II & N1-III	Euro 2	0	0	754 749	3 418 253	3 078 265	2 580 574	1 874 789	1 612 456	1 633 001
Light Commercial Vehicles	Petrol	N1-II & N1-III	Euro 3	0	0	0	459 300	383 743	367 318	315 460	262 623	282 329
Light Commercial Vehicles	Petrol	N1-II & N1-III	Euro 4	0	0	0	0	37 368	123 790	279 371	200 490	230 155
Light Commercial Vehicles	Petrol	N1-II & N1-III	Euro 5	0	0	0	0	0	14 779	78 518	84 061	195 787
Light Commercial Vehicles	Petrol	N1-II & N1-III	Euro 6 a/b/c	0	0	0	0	0	0	31 425	38 068	80 883
Light Commercial Vehicles	Petrol	N1-II & N1-III	Euro 6 d-temp	0	0	0	0	0	0	23 419	26 658	95 678
Light Commercial Vehicles	Diesel	N1-I	Conventional	1 181 067 318	3 176 988 775	2 361 022 096	1 564 373 905	1 011 556 502	540 027 904	338 379 692	250 557 725	241 591 437
Light Commercial Vehicles	Diesel	N1-I	Euro 1	0	743 450 566	2 195 273 459	1 544 860 090	1 161 239 682	700 876 312	482 915 712	364 789 155	358 384 145
Light Commercial Vehicles	Diesel	N1-I	Euro 2	0	0	3 448 674 170	2 421 074 710	2 008 833 770	1 345 184 640	1 037 611 013	811 462 471	817 952 502
Light Commercial Vehicles	Diesel	N1-I	Euro 3	0	0	0	3 033 051 800	2 959 675 792	2 115 340 655	1 753 878 456	1 404 769 347	1 441 475 881
Light Commercial Vehicles	Diesel	N1-I	Euro 4	0	0	0	0	2 079 241 099	1 689 725 142	1 460 723 120	1 184 553 906	1 227 169 585
Light Commercial Vehicles	Diesel	N1-I	Euro 5	0	0	0	0	0	477 704 067	448 481 408	367 771 263	382 633 282
Light Commercial Vehicles	Diesel	N1-I	Euro 6 a/b/c	0	0	0	0	0	110 230 516	267 372 966	234 597 504	249 996 495
Light Commercial Vehicles	Diesel	N1-I	Euro 6 d-temp	0	0	0	0	0	0	122 268 719	110 958 279	120 611 908



National Inventory Report – Portugal



Category	Fuel	Segment	Euro Standard	1990	1995	2000	2005	2010	2015	2019	2020	2021
Light Commercial Vehicles	Diesel	N1-I	Euro 6 d	0.0	0.0	0.0	0.0	0.0	0.0	0.0	0.0	8 955 098.3
Light Commercial Vehicles	Diesel	N1-II & N1-III	Conventional	5 532 090 794	6 186 948 457	4 606 900 348	2 980 822 421	2 074 380 383	1 257 044 429	997 411 201	791 465 061	820 303 960
Light Commercial Vehicles	Diesel	N1-II & N1-III	Euro 1	0	552 858 098	2 466 076 496	1 657 684 171	1 310 250 717	838 608 958	681 216 884	543 306 769	566 193 247
Light Commercial Vehicles	Diesel	N1-II & N1-III	Euro 2	0	0	2 141 417 356	2 078 131 922	1 714 285 137	1 137 806 817	946 163 111	759 384 937	792 227 066
Light Commercial Vehicles	Diesel	N1-II & N1-III	Euro 3	0	0	0	2 170 158 553	2 581 184 902	1 780 069 673	1 499 848 498	1 211 098 678	1 261 812 963
Light Commercial Vehicles	Diesel	N1-II & N1-III	Euro 4	0	0	0	0	2 070 184 479	2 014 554 266	1 798 196 942	1 468 472 669	1 545 242 105
Light Commercial Vehicles	Diesel	N1-II & N1-III	Euro 5	0	0	0	0	0	673 388 571	738 412 301	635 224 290	678 374 220
Light Commercial Vehicles	Diesel	N1-II & N1-III	Euro 6 a/b/c	0	0	0	0	0	354 929 023	1 240 008 586	1 111 636 231	1 223 581 984
Light Commercial Vehicles	Diesel	N1-II & N1-III	Euro 6 d-temp	0	0	0	0	0	0	972 181 441	1 195 602 154	1 281 652 514
Light Commercial Vehicles	Diesel	N1-II & N1-III	Euro 6 d	0.0	0.0	0.0	0.0	0.0	0.0	0.0	0.0	437 823 728.5
Heavy Duty Trucks	Diesel	<=20 t	Conventional	1 238 478 247	1 166 279 618	905 165 778	516 579 017	279 343 089	119 168 159	81 314 715	60 214 549	61 879 049
Heavy Duty Trucks	Diesel	<=20 t	Euro I	0	116 615 712	213 287 245	158 426 380	110 672 725	55 988 175	39 611 378	29 517 611	29 568 487
Heavy Duty Trucks	Diesel	<=20 t	Euro II	0	0	514 267 742	569 781 792	462 542 880	242 067 730	191 327 392	145 602 543	147 058 999
Heavy Duty Trucks	Diesel	<=20 t	Euro III	0	0	0	244 326 541	640 379 801	517 325 658	513 137 433	394 117 146	408 230 116
Heavy Duty Trucks	Diesel	<=20 t	Euro IV	0	0	0	0	725 479 146	677 168 009	589 615 075	469 377 042	490 601 986
Heavy Duty Trucks	Diesel	<=20 t	Euro V	0	0	0	0	166 828 709	630 967 382	692 362 239	575 762 723	603 190 109
Heavy Duty Trucks	Diesel	<=20 t	Euro VI A/B/C	0	0	0	0	0	459 060 360	1 316 817 327	1 137 893 454	1 239 629 206
Heavy Duty Trucks	Diesel	<=20 t	Euro VI D/E	0	0	0	0	0	0	243 679 370	415 637 682	678 703 783
Heavy Duty Trucks	Diesel	20 - 28 t	Conventional	473 796 395	432 071 138	330 358 303	181 130 472	89 832 074	32 089 138	20 317 766	14 341 870	13 939 485
Heavy Duty Trucks	Diesel	20 - 28 t	Euro I	0	37 269 801	72 582 165	55 883 431	35 014 781	16 070 597	11 134 594	8 619 360	8 503 885
Heavy Duty Trucks	Diesel	20 - 28 t	Euro II	0	0	161 059 494	187 796 546	142 853 073	71 512 396	53 133 977	41 596 736	42 983 398
Heavy Duty Trucks	Diesel	20 - 28 t	Euro III	0	0	0	56 432 722	86 212 066	71 046 723	69 146 330	59 042 502	61 563 998
Heavy Duty Trucks	Diesel	20 - 28 t	Euro IV	0	0	0	0	28 664 348	35 045 563	46 350 961	39 991 527	44 025 526
Heavy Duty Trucks	Diesel	20 - 28 t	Euro V	0	0	0	0	5 732 656	18 729 987	39 057 870	34 561 270	39 513 607
Heavy Duty Trucks	Diesel	20 - 28 t	Euro VI A/B/C	0	0	0	0	0	4 524 181	26 776 048	26 583 537	34 788 917
Heavy Duty Trucks	Diesel	20 - 28 t	Euro VI D/E	0	0	0	0	0	0	6 010 319	10 253 070	15 777 721
Heavy Duty Trucks	Diesel	>28 t	Conventional	1 197 276 692	1 119 474 323	626 125 542	224 999 911	66 945 189	15 091 616	6 991 653	4 867 633	4 413 227
Heavy Duty Trucks	Diesel	>28 t	Euro I	0	324 449 813	489 000 184	229 951 663	86 490 660	24 249 006	11 588 840	8 261 260	7 685 602
Heavy Duty Trucks	Diesel	>28 t	Euro II	0	0	1 364 979 970	1 253 923 608	476 304 821	154 375 629	60 644 622	43 155 515	40 068 053
Heavy Duty Trucks	Diesel	>28 t	Euro III	0	0	0	653 350 971	668 661 637	314 229 731	101 532 072	74 661 848	71 876 328
Heavy Duty Trucks	Diesel	>28 t	Euro IV	0	0	0	0	44 476 890	27 764 119	29 218 630	25 214 630	27 504 917
Heavy Duty Trucks	Diesel	>28 t	Euro V	0	0	0	0	3 071 066	5 845 307	9 776 823	8 888 146	10 346 319
Heavy Duty Trucks	Diesel	>28 t	Euro VI A/B/C	0	0	0	0	0	1 917 120	16 726 090	16 144 734	19 773 177
Heavy Duty Trucks	Diesel	>28 t	Euro VI D/E	0	0	0	0	0	0	5 384 811	9 183 588	14 130 728
Buses	Diesel	Urban Buses	Conventional	303 457 923	242 503 352	181 742 593	113 013 364	53 479 559	17 612 789	7 748 708	4 585 617	4 241 993
Buses	Diesel	Urban Buses	Euro I	0	36 901 003	68 417 272	46 762 520	42 018 890	17 179 135	7 630 703	5 054 509	4 368 162
Buses	Diesel	Urban Buses	Euro II	0	0	174 824 260	165 449 718	134 689 591	85 514 685	49 004 684	33 465 347	29 259 716
Buses	Diesel	Urban Buses	Euro III	0	0	0	119 422 639	123 964 868	109 240 475	98 498 090	72 128 273	70 226 662
Buses	Diesel	Urban Buses	Euro IV	0	0	0	0	61 531 186	68 917 192	81 806 403	65 374 474	65 761 230
Buses	Diesel	Urban Buses	Euro V	0	0	0	0	11 342 174	44 925 839	53 644 290	43 209 468	48 004 283
Buses	Diesel	Urban Buses	Euro VI A/B/C	0	0	0	0	0	14 723 371	62 095 839	54 511 158	56 792 873
Buses	Diesel	Urban Buses	Euro VI D/E	0	0	0	0	0	0	9 209 190	10 966 058	16 116 758
Buses	Diesel	Coaches	Conventional	50 778 103	39 210 953	28 471 024	17 610 700	8 801 824	2 902 373	1 220 671	733 213	686 662
Buses	Diesel	Coaches	Euro I	0	6 132 435	10 780 423	7 528 153	7 109 584	2 965 727	1 311 694	853 275	753 781
Buses	Diesel	Coaches	Euro II	0	0	29 740 848	26 727 271	21 598 581	13 772 234	7 793 360	5 291 398	4 521 945
Buses	Diesel	Coaches	Euro III	0	0	0	15 747 127	15 228 660	14 045 835	14 077 198	10 495 279	10 301 096
Buses	Diesel	Coaches	Euro IV	0	0	0	0	7 547 365	8 656 792	11 351 409	9 209 405	9 241 964
Buses	Diesel	Coaches	Euro V	0	0	0	0	1 625 677	6 673 906	8 079 640	6 505 741	7 375 170
Buses	Diesel	Coaches	Euro VI A/B/C	0	0	0	0	0	1 997 253	8 250 230	7 081 252	7 313 304
Buses	Diesel	Coaches	Euro VI D/E	0.0	0.0	0.0	0.0	0.0	0.0	1 202 540.0	1 438 334.6	2 093 372.7
Buses	CNG	Urban CNG Buses	Euro I	0	0	0	0	0	49 169	28 076	25 180	24 978
Buses	CNG	Urban CNG Buses	Euro II	0	0	1 204 723	7 750 076	3 580 913	2 378 500	0	0	0



National Inventory Report – Portugal



Category	Fuel	Segment	Euro Standard	1990	1995	2000	2005	2010	2015	2019	2020	2021
Buses	CNG	Urban CNG Buses	Euro III	0	0	0	11 374 676	5 731 529	6 169 325	3 586 812	2 471 301	2 188 723
Buses	CNG	Urban CNG Buses	EEV	0	0	0	0	13 332 265	15 042 774	27 850 717	33 504 515	40 379 383
L-Category	Petrol	Mopeds 2-stroke <50 cm ³	Conventional	1 668 421 253	1 058 488 627	647 698 167	266 346 701	133 811 425	90 595 069	68 986 936	58 513 236	62 639 481
L-Category	Petrol	Mopeds 2-stroke <50 cm ³	Euro 1	0	0	0	38 238 846	18 517 456	9 464 916	5 206 826	3 883 938	3 546 557
L-Category	Petrol	Mopeds 2-stroke <50 cm ³	Euro 2	0	0	0	60 847 897	50 690 774	23 410 302	13 932 620	10 610 146	10 386 605
L-Category	Petrol	Mopeds 2-stroke <50 cm ³	Euro 3	0	0	0	0	66 171 672	73 793 263	64 247 424	46 913 640	41 586 212
L-Category	Petrol	Mopeds 2-stroke <50 cm ³	Euro 4	0	0	0	0	0	0	7 619 650	9 549 849	10 596 367
L-Category	Petrol	Mopeds 2-stroke <50 cm ³	Euro 5	0.0	0.0	0.0	0.0	0.0	0.0	0.0	0.0	1 962 316.7
L-Category	Petrol	Mopeds 4-stroke <50 cm ³	Conventional	1 668 421 253	1 058 488 627	647 698 167	266 346 701	133 811 425	90 595 069	68 986 936	58 513 236	62 639 481
L-Category	Petrol	Mopeds 4-stroke <50 cm ³	Euro 1	0	0	0	38 238 846	18 517 456	9 464 916	5 206 826	3 883 938	3 546 557
L-Category	Petrol	Mopeds 4-stroke <50 cm ³	Euro 2	0	0	0	60 847 897	50 690 774	23 410 302	13 932 620	10 610 146	10 386 605
L-Category	Petrol	Mopeds 4-stroke <50 cm ³	Euro 3	0	0	0	0	66 171 672	73 793 263	64 247 424	46 913 640	41 586 212
L-Category	Petrol	Mopeds 4-stroke <50 cm ³	Euro 4	0	0	0	0	0	0	7 619 650	9 549 849	10 596 367
L-Category	Petrol	Mopeds 4-stroke <50 cm ³	Euro 5	0.0	0.0	0.0	0.0	0.0	0.0	0.0	0.0	1 962 316.7
L-Category	Petrol	Motorcycles 2-stroke >50 cm ³	Conventional	58 977 967	63 871 477	77 807 269	26 883 119	39 358 177	28 074 022	24 348 011	20 350 138	21 436 270
L-Category	Petrol	Motorcycles 2-stroke >50 cm ³	Euro 1	0	0	0	42 566 434	38 836 120	24 344 815	22 183 146	17 386 866	17 265 309
L-Category	Petrol	Motorcycles 2-stroke >50 cm ³	Euro 2	0	0	0	24 589 930	39 906 520	26 690 793	25 286 603	19 986 305	19 197 775
L-Category	Petrol	Motorcycles 2-stroke >50 cm ³	Euro 3	0	0	0	0	76 701 837	160 106 188	180 332 813	147 746 485	152 285 907
L-Category	Petrol	Motorcycles 2-stroke >50 cm ³	Euro 4	0	0	0	0	0	0	109 609 661	135 489 109	144 932 836
L-Category	Petrol	Motorcycles 2-stroke >50 cm ³	Euro 5	0.0	0.0	0.0	0.0	0.0	0.0	0.0	0.0	26 958 879.4
L-Category	Petrol	Motorcycles 4-stroke <250 cm ³	Conventional	68 832 672	74 537 350	94 183 867	39 191 718	24 348 434	11 891 258	9 512 607	7 949 717	8 373 899
L-Category	Petrol	Motorcycles 4-stroke <250 cm ³	Euro 1	0	0	0	64 269 925	24 922 390	10 688 437	8 979 542	7 027 121	6 977 584
L-Category	Petrol	Motorcycles 4-stroke <250 cm ³	Euro 2	0	0	0	34 255 070	25 365 857	11 603 673	10 138 654	8 011 238	7 707 160
L-Category	Petrol	Motorcycles 4-stroke <250 cm ³	Euro 3	0	0	0	0	43 917 521	73 978 444	77 098 783	64 095 820	64 891 495
L-Category	Petrol	Motorcycles 4-stroke <250 cm ³	Euro 4	0	0	0	0	0	0	42 687 423	51 573 004	60 557 121
L-Category	Petrol	Motorcycles 4-stroke <250 cm ³	Euro 5	0.0	0.0	0.0	0.0	0.0	0.0	0.0	0.0	10 531 269.4
L-Category	Petrol	Motorcycles 4-stroke 250 - 750 cm ³	Conventional	231 637 816	250 852 991	293 463 246	114 050 257	64 535 707	31 120 266	25 274 656	21 124 699	22 251 349
L-Category	Petrol	Motorcycles 4-stroke 250 - 750 cm ³	Euro 1	0	0	0	187 031 533	66 049 922	27 970 737	23 861 795	18 670 809	18 538 418
L-Category	Petrol	Motorcycles 4-stroke 250 - 750 cm ³	Euro 2	0	0	0	99 684 508	67 243 520	30 366 568	26 942 318	21 287 312	20 476 945
L-Category	Petrol	Motorcycles 4-stroke 250 - 750 cm ³	Euro 3	0	0	0	0	116 407 978	193 600 575	204 857 365	170 308 656	172 421 755
L-Category	Petrol	Motorcycles 4-stroke 250 - 750 cm ³	Euro 4	0	0	0	0	0	0	113 428 242	137 037 987	160 905 851
L-Category	Petrol	Motorcycles 4-stroke 250 - 750 cm ³	Euro 5	0.0	0.0	0.0	0.0	0.0	0.0	0.0	0.0	27 986 129.0
L-Category	Petrol	Motorcycles 4-stroke >750 cm ³	Conventional	148 940 640	161 292 714	216 283 981	90 079 307	61 166 174	34 806 235	30 217 814	25 255 682	26 603 868
L-Category	Petrol	Motorcycles 4-stroke >750 cm ³	Euro 1	0	0	0	147 718 691	62 603 021	31 282 861	28 528 865	22 321 833	22 163 050
L-Category	Petrol	Motorcycles 4-stroke >750 cm ³	Euro 2	0	0	0	78 729 055	63 733 418	33 964 678	32 212 558	25 452 512	24 482 836
L-Category	Petrol	Motorcycles 4-stroke >750 cm ³	Euro 3	0	0	0	0	110 335 949	216 523 758	244 917 308	203 618 146	206 141 332
L-Category	Petrol	Motorcycles 4-stroke >750 cm ³	Euro 4	0	0	0	0	0	0	135 615 106	163 838 033	192 376 480
L-Category	Petrol	Motorcycles 4-stroke >750 cm ³	Euro 5	0.0	0.0	0.0	0.0	0.0	0.0	0.0	0.0	33 458 761.7

**Table B-8: Activity data for CRF 1.A.3.c: Fuel consumption from Railways sector (GJ)**

Fuel	Technology	unit	1990	1991	1992	1993	1994	1995	1996	1997	1998	1999	2000	2001	2002	2003	2004	2005
Railways	Gas Oil	TJ	2,390	2,502	2,507	2,293	2,276	2,326	2,119	2,036	1,889	1,859	1,829	1,630	1,522	1,317	1,193	1,110
	Sub-bituminous Coal	TJ	1	0	1	0	1	0	0	0	1	1	1	1	1	1	1	1
	Coke	TJ	0	0	0	0	0	0	0	-	-	-	-	-	-	-	-	-
Fuel	Technology	unit	2006	2007	2008	2009	2010	2011	2012	2013	2014	2015	2016	2017	2018	2019	2020	2021
Railways	Gas Oil	TJ	1 021	1 030	1 088	747	635	554	452	408	429	407	373	397	385	393	347	344
	Sub-bituminous Coal	TJ	1	1	1	1	1	1	1	-	-	-	-	-	-	-	-	-
	Coke	TJ	-	-	-	-	-	-	-	-	-	-	-	-	-	-	-	-



Other Sectors (CRF 1.A.4)

Table B-9: Activity data for CRF 1.A.4.a.i: Fuel consumption in the commercial, services and institutional sector: stationary (TJ)

Fuel	Technology	unit	1990	1991	1992	1993	1994	1995	1996	1997	1998	1999	2000	2001	2002	2003	2004	2005
Liquefied Petroleum Gases	Medium Boilers	TJ	447	490	539	616	577	370	706	995	957	960	1 025	1 230	779	779	682	435
	Stove, Hobs and Ovens	TJ	751	883	1 042	1 282	1 294	898	1 856	2 841	2 980	3 271	3 389	3 977	4 335	4 508	4 732	4 371
Natural Gas & Gas Work Gas	Medium Boilers	TJ	403	446	425	519	525	595	640	649	1 209	1 976	2 443	2 980	3 867	4 521	5 005	4 809
	Heat Pump	TJ	-	-	-	-	-	-	-	-	-	-	11	11	12	15	15	16
	Stove, Hobs and Ovens	TJ	102	111	104	125	124	138	146	145	265	424	612	660	729	826	873	966
	Gas Turbines	TJ	-	-	-	-	-	-	-	-	-	-	255	281	480	567	677	735
Gas Oil	Medium Boilers	TJ	5 640	6 918	8 280	8 446	8 592	7 889	8 726	13 106	16 719	18 352	18 392	21 957	24 195	26 051	29 093	28 452
Wood and Wood Waste	Medium Boilers	TJ	-	-	-	-	-	-	-	-	-	-	-	-	-	-	-	-
	Ovens	TJ	-	-	-	-	-	-	-	-	-	-	-	-	-	-	-	-
Fuel Oil	Medium Boilers ¹	TJ	-	-	-	-	-	-	-	-	231	363	333	246	208	166	241	251
	Medium Boilers ²	TJ	2 367	2 073	1 978	2 058	3 663	4 267	3 297	1 333	2 559	3 022	2 933	3 203	3 326	2 741	2 912	2 932
Fuel	Technology	unit	2006	2007	2008	2009	2010	2011	2012	2013	2014	2015	2016	2017	2018	2019	2020	2021
Liquefied Petroleum Gases	Medium Boilers	TJ	453	450	457	460	430	395	431	421	421	428	418	344	376	240	151	141
	Stove, Hobs and Ovens	TJ	3 896	4 037	4 686	4 343	1 716	1 532	1 488	1 538	2 714	2 956	2 917	2 833	3 737	2 972	2 457	2 301
Natural Gas & Gas Work Gas	Medium Boilers	TJ	5 538	5 999	6 073	7 213	7 457	7 666	8 002	7 804	7 733	8 254	9 149	9 287	9 480	8 972	7 403	8 487
	Heat Pump	TJ	19	24	26	29	37	37	44	51	68	95	73	77	82	81	69	79
	Stove, Hobs and Ovens	TJ	1 017	1 047	1 015	1 087	1 255	1 215	1 269	1 235	1 335	1 394	1 339	1 324	1 315	1 211	972	1 114
	Gas Turbines	TJ	815	1 400	1 491	1 786	2 054	2 248	3 064	3 372	3 354	3 082	3 124	3 298	3 172	3 058	3 050	2 985
Gas Oil	Medium Boilers	TJ	15 348	14 266	10 912	8 971	4 858	3 366	2 720	2 506	2 081	1 749	1 413	1 282	1 614	1 971	1 614	1 240
Wood and Wood Waste	Medium Boilers	TJ	-	-	-	-	-	665	400	458	598	433	452	525	520	499	353	430
	Ovens	TJ	-	-	-	-	-	1 870	1 065	1 005	1 158	860	775	821	745	655	426	518
Fuel Oil	Medium Boilers ¹	TJ	247	436	455	444	465	194	179	76	-	-	-	-	-	-	-	-
	Medium Boilers ²	TJ	3 294	3 125	1 765	1 462	2 208	1 191	851	775	773	1 219	806	706	598	496	433	356



National Inventory Report – Portugal



Table B-10: Activity data for CRF 1.A.4.b.i: Fuel consumption in the residential sector: stationary (TJ)

Fuel	Technology	unit	1990	1991	1992	1993	1994	1995	1996	1997	1998	1999	2000	2001	2002	2003	2004	2005
Liquefied Petroleum Gases	LPG Heaters	TJ	418	483	561	643	702	759	873	898	1 000	1 116	1 405	1 329	1 328	1 072	1 031	1 140
	Condensing boilers	TJ	8 535	8 690	8 954	9 152	8 949	8 691	9 005	8 362	8 418	8 505	7 022	6 822	7 146	6 175	5 950	5 850
	Stove, Hobs and Ovens	TJ	14 506	15 540	16 865	18 175	18 757	19 251	21 111	20 777	22 208	23 866	25 919	23 426	23 092	23 297	23 049	22 322
Natural Gas & Gas Work Gas	Small Boilers	TJ	1 017	1 011	1 008	1 032	967	921	923	925	1 118	1 545	1 867	2 122	2 537	2 627	2 890	3 098
	Condensing boilers	TJ	253	264	276	296	291	291	305	321	407	589	769	899	1 089	1 190	1 320	1 572
	Stove, Hobs and Ovens	TJ	655	677	701	746	727	720	750	782	983	1 413	1 771	2 064	2 539	2 830	3 408	3 724
Gas Oil	Small Boilers	TJ	158	211	286	205	190	201	133	92	106	144	90	82	120	235	474	839
Wood and Wood Waste	Conventional stoves	TJ	31 213	29 612	28 427	27 615	27 143	26 982	26 879	25 961	25 052	24 153	23 581	22 558	21 553	20 567	19 599	18 650
	Open fireplaces	TJ	11 672	11 107	10 695	10 422	10 276	10 246	10 240	9 922	9 606	9 292	9 004	8 683	8 364	8 048	7 735	7 424
	Conventional boilers	TJ	10 229	9 626	9 165	8 829	8 603	8 477	8 369	8 009	7 656	7 310	7 289	6 813	6 353	5 910	5 482	5 070
	Pellet stoves and boilers	TJ	691	1 032	1 357	1 679	2 010	2 360	2 716	2 981	3 226	3 452	3 001	3 490	3 941	4 354	4 731	5 070
	Automatic Boilers	TJ	-	-	-	-	-	-	-	-	-	-	-	-	-	-	-	-
	Manual Boilers	TJ	-	-	-	-	-	-	-	-	-	-	-	-	-	-	-	-
Fuel Oil	-	TJ	64	62	56	51	67	43	43	40	11	4	3	-	-	-	-	-
Other Kerosene	-	TJ	610	579	481	408	395	274	253	226	199	172	145	118	72	-	-	-
Fuel	Technology	unit	2006	2007	2008	2009	2010	2011	2012	2013	2014	2015	2016	2017	2018	2019	2020	2021
Liquefied Petroleum Gases	LPG Heaters	TJ	1 147	1 160	1 179	1 185	1 169	1 090	1 077	1 069	1 049	1 033	1 006	1 026	1 008	1 067	1 126	963
	Condensing boilers	TJ	4 476	4 205	4 180	3 484	3 179	2 081	1 430	1 173	997	836	746	546	336	155	163	140
	Stove, Hobs and Ovens	TJ	21 452	20 052	17 420	17 127	18 867	17 702	17 016	16 706	15 125	14 020	14 315	14 372	13 907	14 513	15 312	13 097
Natural Gas & Gas Work Gas	Small Boilers	TJ	3 063	3 308	3 916	3 847	2 906	2 281	2 554	2 755	2 999	3 025	3 000	3 218	3 650	3 947	4 231	4 285
	Condensing boilers	TJ	1 655	1 813	2 603	2 170	2 759	2 693	2 835	2 829	3 101	3 091	3 110	3 326	3 763	4 059	4 341	4 387
	Stove, Hobs and Ovens	TJ	3 794	4 129	5 405	5 086	6 907	5 877	5 451	4 831	4 752	4 933	4 139	3 996	4 069	3 937	3 761	3 376
Gas Oil	Small Boilers	TJ	829	1 438	2 138	3 717	5 218	3 671	2 729	2 517	2 406	2 232	2 281	1 976	2 347	2 017	2 181	2 080
Wood and Wood Waste	Conventional stoves	TJ	17 929	17 211	16 496	15 783	15 072	15 738	15 620	15 854	15 639	15 436	15 339	15 211	15 083	14 884	15 089	15 019
	Open fireplaces	TJ	7 116	6 811	6 508	6 208	5 911	6 274	6 246	6 359	6 292	6 230	6 210	6 178	6 146	6 085	6 190	6 182
	Conventional boilers	TJ	4 884	4 697	4 511	4 324	4 138	4 104	4 012	4 008	3 890	3 776	3 687	3 591	3 495	3 383	3 361	3 277
	Pellet stoves and boilers	TJ	4 884	4 697	4 511	4 324	4 138	5 136	5 359	5 710	5 904	6 099	6 335	6 559	6 784	6 974	7 360	7 618
	Automatic Boilers	TJ	70	134	193	247	296	275	307	346	376	407	439	471	503	533	578	613
	Manual Boilers	TJ	-	-	-	-	-	-	-	-	-	-	-	-	-	-	-	-
Fuel Oil	-	TJ	-	-	-	-	-	-	-	-	-	-	-	-	-	-	-	-
Other Kerosene	-	TJ	-	-	-	-	-	-	-	-	-	-	-	-	-	-	-	-



National Inventory Report – Portugal



Table B-11: Activity data for CRF 1.A.4.c.i: Fuel consumption in agriculture/forestry/fishing: stationary (TJ)

Fuel	Technology	unit	1990	1991	1992	1993	1994	1995	1996	1997	1998	1999	2000	2001	2002	2003	2004	2005
Gas Oil	Medium Boilers	TJ	3 822	3 767	4 061	4 309	4 253	4 478	4 677	4 153	4 011	4 069	4 478	4 841	5 145	5 850	5 790	5 749
	Reciprocating engines	TJ	425	419	451	479	473	498	520	461	446	452	498	538	572	650	643	639
	-	TJ	6	0	1	1	1	17	2	151	539	565	854	872	641	548	511	540
LPG	Medium Boilers	TJ	527	382	290	345	485	167	260	267	198	410	347	147	419	370	327	128
Natural Gas & Gas Work Gas	Medium Boilers	TJ	-	-	-	-	-	-	-	-	0	0	5	84	129	136	139	160
	Gas Turbines	TJ	-	-	-	-	-	-	-	-	-	-	9	138	162	163	168	195
Wood Waste	Medium boilers	TJ	-	-	-	-	-	-	-	-	-	-	-	-	-	-	-	-
Fuel Oil	Medium Boilers ¹	TJ	-	-	-	-	5	261	253	285	280	278	567	689	814	738	635	740
	Medium Boilers ²	TJ	529	382	294	353	488	179	265	272	202	451	332	133	426	374	236	122
Other Kerosene	-	TJ	93	82	72	55	53	51	49	49	49	49	49	47	50	47	49	55

Fuel	Technology	unit	2006	2007	2008	2009	2010	2011	2012	2013	2014	2015	2016	2017	2018	2019	2020	2021
Gas Oil	Medium Boilers	TJ	5 496	5 495	5 184	4 697	4 620	4 553	4 618	4 766	4 791	4 865	5 044	5 121	5 199	5 212	5 728	5 891
	Reciprocating engines	TJ	611	611	576	522	513	506	513	530	532	541	560	569	578	579	636	655
	-	TJ	692	518	590	717	845	1 132	1 155	1 288	1 312	1 917	1 542	1 490	1 541	1 635	1 432	1 048
LPG	Medium Boilers	TJ	79	110	57	102	155	173	47	34	36	54	38	32	24	12	24	3
Natural Gas & Gas Work Gas	Medium Boilers	TJ	175	215	142	214	147	199	216	292	315	247	205	242	154	262	290	316
	Gas Turbines	TJ	173	169	179	179	304	316	322	313	146	181	209	213	239	291	335	346
Wood Waste	Medium boilers	TJ	-	-	-	-	-	100	159	129	202	130	60	60	60	215	215	76
Fuel Oil	Medium Boilers ¹	TJ	496	183	149	-	-	-	-	-	-	-	-	-	-	-	-	-
	Medium Boilers ²	TJ	86	108	99	151	628	590	145	105	165	165	225	174	153	191	271	107
Other Kerosene	-	TJ	56	32	39	45	39	30	33	30	25	26	21	23	12	10	14	9

Fuel	Technology	unit	2006	2007	2008	2009	2010	2011	2012	2013	2014	2015	2016	2017	2018	2019	2020	2021
Gas Oil	Tractors, Others	TJ	6 107	6 105	5 761	5 219	5 133	5 059	5 131	5 295	5 323	5 406	5 604	5 690	5 777	5 791	6 364	6 546
	Fishing Vessels	TJ	2 875	2 399	2 347	2 883	2 958	2 571	2 541	2 596	2 118	1 893	1 915	1 789	1 826	2 012	2 256	2 657
Thick Fuel Oil	Fishing Vessels	TJ	-	-	-	-	-	-	-	-	-	-	-	-	-	-	-	-
Thin Fuel Oil	Fishing Vessels	TJ	-	-	-	-	-	-	-	-	-	-	-	-	-	-	-	-
Gasoline	Residential: 2-Stroke	TJ	0	-	-	-	-	-	-	-	-	-	-	-	-	-	-	-
	Agriculture: 4-Stroke	TJ	70	63	42	62	45	31	20	36	20	33	42	42	43	15	21	20
Other Kerosene	Commercial: mobile	TJ	0	0	1	5	1	2	2	4	0	2	0	0	0	0	2	0
	Residential: mobile	TJ	31	25	29	22	27	27	18	20	11	8	7	7	5	4	2	3



National Inventory Report – Portugal



Table B-12: Activity data for CRF 1.A.4.a.ii, 1.A.4.b.ii, 1.A.4.c.ii and 1.A.4.c.iii: Fuel consumption: mobile sources (TJ)

Fuel	Technology	unit	1990	1991	1992	1993	1994	1995	1996	1997	1998	1999	2000	2001	2002	2003	2004	2005
Gas Oil	Tractors, Others	TJ	4 247	4 186	4 512	4 787	4 726	4 975	5 197	4 614	4 456	4 521	4 975	5 379	5 717	6 500	6 433	6 388
	Fishing Vessels	TJ	5 392	5 518	4 876	4 336	4 456	3 949	3 661	3 395	3 397	3 299	4 820	4 922	3 618	2 796	3 316	2 748
Thick Fuel Oil	Fishing Vessels	TJ	-	-	-	-	207	48	12	11	21	11	-	-	-	-	-	-
Thin Fuel Oil	Fishing Vessels	TJ	-	3	-	41	276	27	16	10	11	6	2	-	-	-	-	-
Gasoline	Residential: 2-Stroke	TJ	6	8	6	6	6	10	14	15	15	6	1	0	0	0	0	0
	Agriculture: 4-Stroke	TJ	35	36	48	45	45	45	45	44	47	105	99	93	87	81	75	68
Other Kerosene	Commercial: mobile	TJ	74	33	64	74	24	13	13	15	21	14	4	7	9	7	7	6
	Residential: mobile	TJ	184	174	145	123	119	82	76	76	76	76	76	76	76	90	89	50
Fuel	Technology	unit	2006	2007	2008	2009	2010	2011	2012	2013	2014	2015	2016	2017	2018	2019	2020	2021
Gas Oil	Tractors, Others	TJ	6 107	6 105	5 761	5 219	5 133	5 059	5 131	5 295	5 323	5 406	5 604	5 690	5 777	5 791	6 364	6 546
	Fishing Vessels	TJ	2 875	2 399	2 347	2 883	2 958	2 571	2 541	2 596	2 118	1 893	1 915	1 789	1 826	2 012	2 256	2 657
Thick Fuel Oil	Fishing Vessels	TJ	-	-	-	-	-	-	-	-	-	-	-	-	-	-	-	-
Thin Fuel Oil	Fishing Vessels	TJ	-	-	-	-	-	-	-	-	-	-	-	-	-	-	-	-
Gasoline	Residential: 2-Stroke	TJ	0	-	-	-	-	-	-	-	-	-	-	-	-	-	-	-
	Agriculture: 4-Stroke	TJ	70	63	42	62	45	31	20	36	20	33	42	42	43	15	21	20
Other Kerosene	Commercial: mobile	TJ	0	0	1	5	1	2	2	4	0	2	0	0	0	0	2	0
	Residential: mobile	TJ	31	25	29	22	27	27	18	20	11	8	7	7	5	4	2	3



Other (Not Else-where specified) (CRF 1.A.5)

Table B-13: Activity data for CRF 1.A.5.b: Energy Consumption in Military aviation (TJ)

Fuel Sales		NAPFUE	1990	1991	1992	1993	1994	1995	1996	1997	1998	1999	2000	2001	2002	2003	2004	2005
Jet Fuel	L	207	1 344	1 504	1 127	1 065	1 188	1 149	1 471	1 413	1 474	1 127	1 338	1 338	939	749	570	1 025

Fuel Sales		NAPFUE	2006	2007	2008	2009	2010	2011	2012	2013	2014	2015	2016	2017	2018	2019	2020	2021
Jet Fuel	L	207	1 064	1 026	1 200	1 205	1 208	1 086	683	822	961	1 065	614	612	821	847	927	1 020



Annex C: Agriculture

Updated: March 2023

Table C-1: Livestock numbers (thousand)

Type	Subtype	1990	1991	1992	1993	1994	1995	1996	1997	1998	1999	2000
Dairy cattle	Dairy cows	394	388	381	383	382	383	380	379	375	369	353
Non-dairy cattle	Beef calfs (<1 yr)	46	52	53	53	58	60	64	64	65	66	67
	Calfs M.Rep. (<1 yr)	186	185	182	176	167	162	155	151	149	149	144
	Calfs F Rep. (<1 yr)	177	178	178	174	164	158	152	152	155	165	174
	Males 1-2 yrs	112	114	114	108	103	103	105	101	95	86	82
	Beef Fem. 1-2 yrs	18	19	20	22	22	22	24	24	24	20	17
	Females rep. 1-2 yrs	111	115	112	109	106	109	112	109	108	116	127
	Steers (>2 yrs)	38	38	36	37	35	33	33	31	31	29	26
	Heifers Beef (>2 yrs)	4	5	7	9	10	10	9	9	9	7	6
	Heifers rep. (>2 yrs)	45	46	45	48	50	52	51	50	52	60	67
	non-dairy cows	242	245	238	241	252	273	296	316	332	338	345
Swine	Piglets (<20 kg)	727	756	756	750	735	726	703	701	695	691	663
	Fatt. Pigs (20-50 kg)	662	675	660	671	668	660	633	631	633	623	585
	Fatt. Pigs (50-80 kg)	525	545	544	539	532	525	505	496	492	498	483
	Fatt. Pigs (80-110 kg)	218	227	226	225	210	198	179	177	174	176	174
	Fatt. Pigs (> 110 kg)	44	46	46	47	45	44	40	39	38	38	38
	Boars (>50 kg)	26	28	27	28	28	26	24	23	23	22	20
	Sows, pregnant	210	219	218	220	216	211	204	204	202	201	195
	Sows, non-pregnant	124	131	135	136	134	132	127	128	127	127	124
Sheep	Ewes	2 292	2 293	2 257	2 268	2 303	2 339	2 376	2 368	2 367	2 388	2 410
	Other Ovine	663	725	789	794	811	817	813	802	834	840	734
	Lambs	307	326	320	300	279	278	292	297	301	307	319
Goats	Does	614	588	556	538	528	517	509	498	485	472	460
	Other Caprine	149	156	166	160	153	151	147	151	154	151	129
	kids	47	49	47	44	45	41	41	36	37	36	33
Horses	Horses	33	38	40	42	44	48	52	54	56	57	58
Asses	Asses and Mules.	118	116	114	114	109	103	96	90	82	75	69
Poultry	Hens, reproductive	3 421	3 300	3 116	2 941	2 947	3 271	3 477	3 390	2 982	2 636	2 644
	Hens eggs	7 539	7 695	7 932	8 159	8 143	7 745	7 392	7 322	7 859	8 627	9 060
	Broilers	18 524	18 812	19 243	19 674	19 530	18 813	18 355	18 733	20 538	22 936	24 374
	Turkeys	1 149	1 122	1 082	1 041	996	945	936	972	1 061	1 158	1 208
	Other poultry	1 571	1 559	1 542	1 525	1 528	1 551	1 552	1 509	1 494	1 552	1 622
Other	Rabbits*	475	464	447	430	415	401	384	363	346	338	336



National Inventory Report - Portugal



Table C-1: Livestock numbers (thousand)

Type	Subtype	2001	2002	2003	2004	2005	2006	2007	2008	2009	2010	2011	
Dairy cattle	Dairy cows	331	311	297	294	290	284	275	269	263	255	247	
Non-dairy cattle	Beef calves (<1 yr)	72	75	82	91	104	108	108	108	109	114	120	
	Calves M.Rep. (<1 yr)	140	137	141	140	136	131	129	127	123	123	128	
	Calves F Rep. (<1 yr)	180	186	186	187	183	180	178	174	169	171	179	
	Males 1-2 yrs	81	80	80	79	81	77	75	73	72	66	60	
	Beef Fem. 1-2 yrs	14	14	15	16	17	17	16	17	18	20	19	
	Females rep. 1-2 yrs	135	136	133	135	135	139	139	139	141	142	137	132
	Steers (>2 yrs)	24	23	23	23	25	28	28	31	33	34	38	41
	Heifers Beef (>2 yrs)	6	8	8	8	9	9	9	9	9	10	12	13
	Heifers rep. (>2 yrs)	77	80	86	90	94	96	96	96	97	102	110	111
	non-dairy cows	352	362	371	382	397	411	411	425	432	436	438	440
Swine	Piglets (<20 kg)	626	591	571	570	574	583	590	592	602	597	614	
	Fatt. Pigs (20-50 kg)	535	493	471	467	467	466	468	464	460	448	446	
	Fatt. Pigs (50-80 kg)	446	402	374	373	368	362	356	357	362	360	362	
	Fatt. Pigs (80-110 kg)	184	197	208	213	214	221	222	227	237	244	251	
	Fatt. Pigs (> 110 kg)	43	42	43	40	41	43	44	44	40	36	30	
	Boars (>50 kg)	19	17	16	14	12	12	11	10	8	7	6	
	Sows, pregnant	197	196	198	194	191	189	185	183	181	179	172	
	Sows, non-pregnant	111	91	73	67	68	70	71	70	69	66	66	
Sheep	Ewes	2 388	2 328	2 282	2 273	2 293	2 275	2 225	2 137	2 030	1 915	1 811	
	Other Ovine	505	299	204	216	234	267	250	226	206	192	179	
	Lambs	320	330	324	329	322	328	340	337	307	277	264	
Goats	Does	440	417	392	382	380	380	373	365	358	356	353	
	Other Caprine	91	62	48	52	57	65	59	52	44	40	38	
	kids	30	29	28	28	26	25	28	30	31	29	29	
Horses	Horses	59	59	59	59	60	62	65	71	82	92	98	
Asses	Asses and Mules.	63	61	60	61	60	57	53	45	33	24	19	
Poultry	Hens, reproductive	2 780	3 019	3 206	3 253	3 056	2 800	2 717	2 877	3 218	3 453	3 542	
	Hens eggs	9 089	8 739	8 440	7 942	7 349	6 830	6 490	6 758	7 341	7 867	7 883	
	Broilers	24 259	22 590	20 921	19 620	18 686	17 885	16 848	16 780	17 915	19 207	19 452	
	Turkeys	1 201	1 139	1 077	963	798	799	1 017	1 318	1 485	1 445	1 331	
	Other poultry	1 634	1 588	1 542	1 471	1 376	1 322	1 332	1 414	1 504	1 522	1 460	
Other	Rabbits*	332	325	318	306	289	270	254	251	255	255	243	



National Inventory Report - Portugal



Table C-1: Livestock numbers (thousand)

Type	Subtype	2012	2013	2014	2015	2016	2017	2018	2019	2020	2021
Dairy cattle	Dairy cows	241	236	233	235	238	240	237	235	233	232
Non-dairy cattle	Beef calves (<1 yr)	125	119	113	112	114	114	112	109	107	103
	Calfs M.Rep. (<1 yr)	136	136	142	152	162	166	165	172	175	182
	Calfs F Rep. (<1 yr)	190	191	198	209	221	226	224	232	236	244
	Males 1-2 yrs	55	54	53	58	67	74	75	70	70	65
	Beef Fem. 1-2 yrs	20	19	17	15	14	14	14	15	16	16
	Females rep. 1-2 yrs	131	135	139	148	159	165	163	158	157	155
	Steers (>2 yrs)	44	42	39	37	38	45	53	60	62	60
	Heifers Beef (>2 yrs)	14	14	15	15	14	15	15	14	12	11
	Heifers rep. (>2 yrs)	110	105	103	96	92	90	95	98	98	94
	non-dairy cows	442	443	450	461	474	483	487	492	497	504
Swine	Piglets (<20 kg)	634	658	681	713	729	739	738	771	797	815
	Fatt. Pigs (20-50 kg)	455	464	472	485	490	488	471	469	453	440
	Fatt. Pigs (50-80 kg)	366	366	369	380	387	385	378	381	387	394
	Fatt. Pigs (80-110 kg)	255	263	273	285	294	301	311	312	319	309
	Fatt. Pigs (> 110 kg)	27	25	28	30	33	33	34	34	45	51
	Boars (>50 kg)	5	5	5	6	5	6	5	5	5	5
	Sows, pregnant	166	159	159	162	164	163	162	163	163	160
	Sows, non-pregnant	66	68	69	71	72	73	72	73	72	72
Sheep	Ewes	1 735	1 683	1 638	1 620	1 639	1 659	1 666	1 664	1 668	1 678
	Other Ovine	160	192	215	237	265	314	367	378	406	426
	Lambs	267	237	213	194	204	200	195	191	186	185
Goats	Does	349	342	333	324	323	330	337	333	322	312
	Other Caprine	35	37	38	39	36	36	37	38	38	37
	kids	28	26	24	20	20	19	19	19	18	18
Horses	Horses	94	87	82	78	74	72	75	82	85	87
Asses	Asses and Mules.	18	17	13	11	10	10	10	9	9	9
Poultry	Hens, reproductive	3 396	3 179	3 047	2 920	2 890	2 979	3 306	3 767	4 109	4 260
	Hens eggs	7 475	7 138	6 857	6 710	6 607	7 090	8 038	9 556	10 533	11 041
	Broilers	18 650	17 847	18 096	19 395	21 745	24 413	27 398	30 702	32 904	34 006
	Turkeys	1 144	956	836	785	800	926	1 160	1 505	1 735	1 849
	Other poultry	1 319	1 178	1 167	1 284	1 530	1 869	2 300	2 823	3 172	3 346
Other	Rabbits*	218	193	170	148	128	121	128	148	162	169



National Inventory Report - Portugal



Table C-2: Share (in %) of livestock population (by sub class) living in cool regions – complete time series

Type	Subtype	1990	1991	1992	1993	1994	1995	1996	1997	1998	1999	2000
Dairy cattle	Dairy cows	64.38	63.33	62.92	63.46	64.26	64.72	64.44	63.76	62.82	61.02	59.66
Non-dairy cattle	Beef calves (<1 yr)	80.12	74.76	66.13	55.54	52.34	53.55	56.50	58.77	61.34	66.31	68.07
	Calfs M.Rep. (<1 yr)	55.75	53.88	54.31	53.16	51.95	50.28	49.54	49.68	49.21	46.14	41.41
	Calfs F Rep. (<1 yr)	55.75	54.47	55.44	54.01	53.52	52.47	52.49	51.25	49.22	45.86	43.64
	Males 1-2 yrs	54.70	53.00	51.42	50.09	53.06	53.94	54.53	53.53	53.02	51.14	49.62
	Beef Fem. 1-2 yrs	50.68	43.86	44.89	44.38	48.81	46.19	44.86	44.53	43.87	40.87	35.13
	Females rep. 1-2 yrs	51.30	47.11	46.40	45.64	48.35	46.38	45.76	44.52	42.79	41.60	40.89
	Steers (>2 yrs)	69.32	68.40	65.31	59.56	54.75	52.66	52.11	49.83	48.16	42.76	38.27
	Heifers Beef (>2 yrs)	43.44	46.67	50.28	51.69	57.12	59.66	65.36	61.71	58.67	54.75	49.31
	Heifers rep. (>2 yrs)	42.16	42.68	45.22	46.78	45.52	43.30	43.91	42.91	41.68	41.03	41.93
non-dairy cows	43.19	41.36	38.96	36.28	34.05	33.09	32.38	32.04	31.15	29.42	28.20	
Swine	Piglets (<20 kg)	47.97	48.47	48.52	47.40	46.50	46.01	45.99	46.04	45.92	45.46	44.83
	Fatt. Pigs (20-50 kg)	45.06	44.00	44.77	45.11	45.69	45.04	45.05	44.94	44.51	43.74	42.62
	Fatt. Pigs (50-80 kg)	48.49	46.83	47.58	46.38	45.85	45.19	44.90	45.29	45.48	45.48	44.45
	Fatt. Pigs (80-110 kg)	47.73	45.78	46.43	44.88	44.32	43.53	43.32	43.75	44.21	44.27	42.97
	Fatt. Pigs (> 110 kg)	48.80	46.15	46.64	44.25	44.04	43.81	44.66	44.92	45.12	44.80	42.37
	Boars (>50 kg)	47.15	48.31	48.04	49.46	49.41	48.66	48.19	46.58	45.47	45.33	47.91
	Sows, pregnant	43.45	44.26	45.74	46.54	46.60	45.88	46.13	45.84	45.81	45.56	44.65
	Sows, non-pregnant	47.54	49.58	50.09	48.68	46.65	45.92	46.54	46.30	46.33	45.95	44.90
Sheep	Ewes	31.33	31.25	31.54	32.17	32.53	32.87	33.03	33.45	33.77	33.88	33.72
	Other Ovine	28.94	29.69	30.30	30.73	30.34	30.04	29.38	28.63	27.61	25.87	24.47
	Lambs	31.33	31.26	31.52	32.10	32.51	32.87	33.03	33.46	33.78	33.88	33.71
Goats	Does	56.28	56.02	55.40	55.26	55.81	56.60	57.45	57.67	57.13	56.88	55.82
	Other Caprine	60.90	61.70	62.44	62.06	61.12	59.92	58.62	58.62	56.71	55.33	53.69
	kids	56.28	55.96	55.38	55.26	55.92	56.61	57.37	57.66	57.13	56.89	55.90
Horses	Horses	41.74	41.74	41.74	41.74	41.74	41.60	42.28	43.19	43.86	43.67	43.69
Asses	Asses and Mules.	67.97	67.97	67.97	67.97	67.97	68.42	69.16	70.29	71.07	71.77	72.39
Poultry	Hens, reproductive	76.65	76.64	76.61	76.58	76.88	77.56	78.40	79.16	79.52	79.33	78.76
	Hens eggs	76.65	76.64	76.61	76.58	76.86	77.42	78.33	79.28	79.54	79.24	78.75
	Broilers	72.05	71.93	71.75	71.58	70.74	69.16	67.89	67.86	68.66	69.02	69.19
	Turkeys	56.54	57.01	57.75	58.55	59.29	59.97	60.59	61.18	60.74	59.54	59.31
	Other poultry	67.11	67.21	67.38	67.54	66.94	65.60	64.86	65.44	65.18	62.82	60.07
Other	Rabbits*	80.64	80.25	79.62	78.95	79.46	81.27	83.46	84.73	84.90	85.02	85.25



National Inventory Report - Portugal



Subtype		2012	2013	2014	2015	2016	2017	2018	2019	2020	2021
Dairy cattle	Dairy cows	241	236	233	235	238	240	237	235	233	232
Non-dairy cattle	Beef calves (<1 yr)	125	119	113	112	114	114	112	109	107	103
	Calfs M.Rep. (<1 yr)	136	136	142	152	162	166	165	172	175	182
	Calfs F Rep. (<1 yr)	190	191	198	209	221	226	224	232	236	244
	Males 1-2 yrs	55	54	53	58	67	74	75	70	70	65
	Beef Fem. 1-2 yrs	20	19	17	15	14	14	14	15	16	16
	Females rep. 1-2 yrs	131	135	139	148	159	165	163	158	157	155
	Steers (>2 yrs)	44	42	39	37	38	45	53	60	62	60
	Heifers Beef (>2 yrs)	14	14	15	15	14	15	15	14	12	11
	Heifers rep. (>2 yrs)	110	105	103	96	92	90	95	98	98	94
	non-dairy cows	442	443	450	461	474	483	487	492	497	504
Swine	Piglets (<20 kg)	634	658	681	713	729	739	738	771	797	815
	Fatt. Pigs (20-50 kg)	455	464	472	485	490	488	471	469	453	440
	Fatt. Pigs (50-80 kg)	366	366	369	380	387	385	378	381	387	394
	Fatt. Pigs (80-110 kg)	255	263	273	285	294	301	311	312	319	309
	Fatt. Pigs (> 110 kg)	27	25	28	30	33	33	34	34	45	51
	Boars (>50 kg)	5	5	5	6	5	6	5	5	5	5
	Sows, pregnant	166	159	159	162	164	163	162	163	163	160
	Sows, non-pregnant	66	68	69	71	72	73	72	73	72	72
Sheep	Ewes	1 735	1 683	1 638	1 620	1 639	1 659	1 666	1 664	1 668	1 678
	Other Ovine	160	192	215	237	265	314	367	378	406	426
	Lambs	267	237	213	194	204	200	195	191	186	185
Goats	Does	349	342	333	324	323	330	337	333	322	312
	Other Caprine	35	37	38	39	36	36	37	38	38	37
	kids	28	26	24	20	20	19	19	19	18	18
Horses	Horses	94	87	82	78	74	72	75	82	85	87
Asses	Asses and Mules.	18	17	13	11	10	10	10	9	9	9
Poultry	Hens, reproductive	3 396	3 179	3 047	2 920	2 890	2 979	3 306	3 767	4 109	4 260
	Hens eggs	7 475	7 138	6 857	6 710	6 607	7 090	8 038	9 556	10 533	11 041
	Broilers	18 650	17 847	18 096	19 395	21 745	24 413	27 398	30 702	32 904	34 006
	Turkeys	1 144	956	836	785	800	926	1 160	1 505	1 735	1 849
	Other poultry	1 319	1 178	1 167	1 284	1 530	1 869	2 300	2 823	3 172	3 346
Other	Rabbits*	218	193	170	148	128	121	128	148	162	169



National Inventory Report - Portugal



Table C-2: Share (in %) of livestock population (by sub class) living in cool regions – complete time series

Type	Subtype	2001	2002	2003	2004	2005	2006	2007	2008	2009	2010	2011
Dairy cattle	Dairy cows	58.11	57.36	56.34	55.72	54.50	53.35	52.15	51.71	50.71	49.54	48.43
Non-dairy cattle	Beef calves (<1 yr)	69.47	67.79	59.03	52.77	47.70	49.34	48.92	48.43	47.45	46.56	45.35
	Calves M.Rep. (<1 yr)	35.30	32.83	32.24	32.22	29.46	26.68	24.20	24.08	24.41	25.40	25.48
	Calves F Rep. (<1 yr)	42.07	40.56	38.94	36.23	34.52	32.60	31.88	31.51	32.19	33.33	33.67
	Males 1-2 yrs	45.58	41.97	40.26	39.88	39.94	39.40	39.09	40.43	41.31	42.70	43.33
	Beef Fem. 1-2 yrs	29.02	28.59	26.06	23.28	27.84	33.79	39.17	39.94	42.15	40.87	38.06
	Females rep. 1-2 yrs	40.68	39.73	39.16	38.70	36.75	35.55	34.52	34.59	35.43	37.18	38.83
	Steers (>2 yrs)	32.85	31.67	30.32	30.77	29.90	29.66	28.82	29.37	29.68	29.26	29.00
	Heifers Beef (>2 yrs)	36.64	41.06	41.29	45.56	48.59	54.58	58.10	53.93	50.23	41.96	36.45
	Heifers rep. (>2 yrs)	42.72	40.70	39.12	36.17	35.67	35.20	35.60	34.35	32.06	31.88	32.42
non-dairy cows	26.92	26.15	24.62	22.71	21.28	20.01	19.19	18.63	18.63	18.84	18.88	
Swine	Piglets (<20 kg)	44.44	44.01	43.27	42.12	41.84	41.65	40.90	39.55	38.14	37.59	36.40
	Fatt. Pigs (20-50 kg)	41.41	40.13	39.27	38.05	37.70	37.99	38.43	38.15	37.23	36.66	35.58
	Fatt. Pigs (50-80 kg)	42.67	40.45	38.79	38.15	37.97	37.86	37.53	36.88	36.54	36.43	35.85
	Fatt. Pigs (80-110 kg)	40.49	38.48	37.66	37.74	38.23	38.16	37.34	35.79	34.48	33.47	33.00
	Fatt. Pigs (> 110 kg)	36.85	34.06	32.14	32.57	33.11	34.90	34.65	32.27	29.25	28.10	27.27
	Boars (>50 kg)	50.09	50.52	50.75	51.81	52.73	51.89	49.57	50.55	49.83	48.74	44.58
	Sows, pregnant	42.55	40.22	39.07	38.79	39.20	39.44	39.54	39.56	39.32	38.84	38.34
	Sows, non-pregnant	43.63	43.48	45.13	46.45	45.75	45.16	44.67	44.54	44.29	44.05	42.51
Sheep	Ewes	33.31	33.03	32.86	33.04	33.51	33.94	34.25	34.42	34.83	35.33	35.68
	Other Ovine	23.51	23.25	24.95	24.38	24.39	25.42	26.30	26.68	26.85	28.43	28.61
	Lambs	33.31	33.02	32.86	33.03	33.50	33.95	34.26	34.42	34.78	35.32	35.69
Goats	Does	55.14	53.98	53.93	54.17	54.85	55.13	55.21	54.94	54.64	53.77	52.94
	Other Caprine	55.18	57.83	62.02	62.16	62.38	60.99	60.44	59.49	59.66	58.84	55.47
	kids	55.25	53.96	53.92	54.15	54.82	55.11	55.16	54.93	54.65	53.76	52.96
Horses	Horses	43.82	43.74	43.19	42.64	42.77	43.07	43.80	44.31	45.42	45.80	45.24
Asses	Asses and Mules.	73.12	73.77	74.00	74.11	73.92	73.91	74.10	75.00	78.06	82.71	87.96
Poultry	Hens, reproductive	78.51	78.52	78.54	78.66	78.91	79.05	78.89	78.38	77.84	77.73	77.94
	Hens eggs	78.51	78.52	78.54	78.65	78.92	79.06	78.91	78.38	77.83	77.73	77.94
	Broilers	69.52	70.10	70.81	71.59	72.39	72.71	72.60	72.06	71.62	71.91	72.75
	Turkeys	60.67	63.83	67.23	69.54	70.34	72.72	77.28	80.61	82.77	83.72	84.13
	Other poultry	58.67	58.38	57.92	56.86	55.18	53.92	53.78	50.88	44.89	40.49	40.57
Other	Rabbits*	85.67	86.28	86.93	87.29	87.35	87.12	86.91	87.39	88.46	89.49	89.99



National Inventory Report - Portugal



Subtype		2012	2013	2014	2015	2016	2017	2018	2019	2020	2021
Dairy cattle	Dairy cows	241	236	233	235	238	240	237	235	233	232
Non-dairy cattle	Beef calves (<1 yr)	125	119	113	112	114	114	112	109	107	103
	Calves M.Rep. (<1 yr)	136	136	142	152	162	166	165	172	175	182
	Calves F Rep. (<1 yr)	190	191	198	209	221	226	224	232	236	244
	Males 1-2 yrs	55	54	53	58	67	74	75	70	70	65
	Beef Fem. 1-2 yrs	20	19	17	15	14	14	14	15	16	16
	Females rep. 1-2 yrs	131	135	139	148	159	165	163	158	157	155
	Steers (>2 yrs)	44	42	39	37	38	45	53	60	62	60
	Heifers Beef (>2 yrs)	14	14	15	15	14	15	15	14	12	11
	Heifers rep. (>2 yrs)	110	105	103	96	92	90	95	98	98	94
	non-dairy cows	442	443	450	461	474	483	487	492	497	504
Swine	Piglets (<20 kg)	634	658	681	713	729	739	738	771	797	815
	Fatt. Pigs (20-50 kg)	455	464	472	485	490	488	471	469	453	440
	Fatt. Pigs (50-80 kg)	366	366	369	380	387	385	378	381	387	394
	Fatt. Pigs (80-110 kg)	255	263	273	285	294	301	311	312	319	309
	Fatt. Pigs (> 110 kg)	27	25	28	30	33	33	34	34	45	51
	Boars (>50 kg)	5	5	5	6	5	6	5	5	5	5
	Sows, pregnant	166	159	159	162	164	163	162	163	163	160
	Sows, non-pregnant	66	68	69	71	72	73	72	73	72	72
Sheep	Ewes	1 735	1 683	1 638	1 620	1 639	1 659	1 666	1 664	1 668	1 678
	Other Ovine	160	192	215	237	265	314	367	378	406	426
	Lambs	267	237	213	194	204	200	195	191	186	185
Goats	Does	349	342	333	324	323	330	337	333	322	312
	Other Caprine	35	37	38	39	36	36	37	38	38	37
	kids	28	26	24	20	20	19	19	19	18	18
Horses	Horses	94	87	82	78	74	72	75	82	85	87
Asses	Asses and Mules.	18	17	13	11	10	10	10	9	9	9
Poultry	Hens, reproductive	3 396	3 179	3 047	2 920	2 890	2 979	3 306	3 767	4 109	4 260
	Hens eggs	7 475	7 138	6 857	6 710	6 607	7 090	8 038	9 556	10 533	11 041
	Broilers	18 650	17 847	18 096	19 395	21 745	24 413	27 398	30 702	32 904	34 006
	Turkeys	1 144	956	836	785	800	926	1 160	1 505	1 735	1 849
	Other poultry	1 319	1 178	1 167	1 284	1 530	1 869	2 300	2 823	3 172	3 346
Other	Rabbits*	218	193	170	148	128	121	128	148	162	169



National Inventory Report - Portugal



Table C-2: Share (in %) of livestock population (by sub class) living in cool regions – complete time series

Type	Subtype	2012	2013	2014	2015	2016	2017	2018	2019	2020	2021
Dairy cattle	Dairy cows	47.66	47.24	46.99	47.24	47.31	47.10	46.69	46.39	46.07	45.77
Non-dairy cattle	Beef calves (<1 yr)	45.29	45.34	45.70	44.12	42.89	43.72	45.61	46.86	46.14	46.04
	Calfs M.Rep. (<1 yr)	24.98	24.24	23.69	23.03	22.25	21.21	20.70	20.25	20.41	19.58
	Calfs F Rep. (<1 yr)	33.25	32.69	32.12	31.82	31.03	29.80	29.42	29.39	30.15	28.92
	Males 1-2 yrs	43.63	44.23	44.22	42.24	37.42	34.16	33.63	34.76	34.61	34.07
	Beef Fem. 1-2 yrs	34.41	34.01	34.19	36.47	37.10	38.49	37.25	35.19	32.67	31.07
	Females rep. 1-2 yrs	38.99	38.45	37.96	36.54	34.60	32.94	32.45	32.60	32.91	33.45
	Steers (>2 yrs)	28.68	27.23	25.65	23.86	23.04	21.32	19.53	18.74	18.43	18.69
	Heifers Beef (>2 yrs)	31.85	31.09	31.95	34.67	34.89	41.48	46.69	51.12	35.54	13.37
	Heifers rep. (>2 yrs)	34.09	33.93	33.85	31.57	28.14	23.03	19.63	17.92	18.63	19.50
non-dairy cows	18.79	18.84	18.81	18.78	18.69	18.68	18.71	18.61	18.53	18.31	
Swine	Piglets (<20 kg)	35.60	34.48	34.58	35.39	36.27	37.17	40.42	43.38	45.65	45.46
	Fatt. Pigs (20-50 kg)	34.71	33.23	32.77	32.19	32.59	32.43	36.40	39.55	43.50	43.32
	Fatt. Pigs (50-80 kg)	34.88	33.73	33.44	33.24	33.02	32.87	36.43	39.79	42.27	41.19
	Fatt. Pigs (80-110 kg)	32.46	32.18	32.02	32.36	31.85	31.95	35.03	38.45	40.43	40.32
	Fatt. Pigs (> 110 kg)	25.58	25.99	28.16	29.18	28.94	29.13	27.89	24.94	20.87	20.63
	Boars (>50 kg)	38.95	42.78	39.23	42.04	39.51	42.30	47.66	52.00	58.34	58.33
	Sows, pregnant	38.09	38.08	38.25	38.76	39.63	40.33	43.15	45.40	47.96	48.16
	Sows, non-pregnant	40.86	39.34	39.17	38.96	39.11	39.07	42.59	46.38	50.39	50.32
Sheep	Ewes	35.82	35.86	35.46	34.64	33.63	33.03	32.50	32.14	31.93	31.77
	Other Ovine	28.53	25.38	25.16	24.43	23.60	22.59	20.96	19.54	17.43	17.29
	Lambs	35.83	35.85	35.49	34.58	33.63	33.05	32.51	32.13	31.93	31.76
Goats	Does	52.63	53.04	53.41	53.18	54.56	55.89	57.55	57.58	57.68	57.28
	Other Caprine	52.07	48.22	46.87	45.83	45.80	44.90	44.63	44.05	44.51	44.96
	kids	52.65	53.03	53.40	53.18	54.53	55.79	57.56	57.58	57.68	57.25
Horses	Horses	44.74	44.88	45.84	45.20	43.10	41.87	41.90	43.22	41.61	39.94
Asses	Asses and Mules.	87.64	86.79	88.48	86.61	85.37	80.19	82.73	84.93	87.89	87.92
Poultry	Hens, reproductive	78.51	78.99	80.10	81.91	84.52	86.88	88.77	90.17	91.00	91.43
	Hens eggs	78.51	78.99	80.10	81.94	84.52	86.91	88.82	90.19	91.01	91.43
	Broilers	74.27	75.87	75.95	74.61	72.35	73.10	76.03	80.50	83.08	84.29
	Turkeys	83.79	82.97	83.10	84.77	88.02	88.85	87.93	86.37	85.77	85.57
	Other poultry	45.60	52.02	52.47	46.54	37.08	39.91	49.81	63.04	69.81	72.84
Other	Rabbits*	89.96	89.90	89.56	88.81	87.47	87.16	88.15	90.01	90.99	91.43



National Inventory Report - Portugal



Table C-3: Methane Emission Factors from Manure Management (kg.hd⁻¹.year⁻¹), by livestock category – complete time series

Type	Subtype	1990	1991	1992	1993	1994	1995	1996	1997	1998	1999	2000
Dairy cattle	Dairy cows	14.62	14.81	14.91	14.59	14.98	15.44	15.88	16.18	16.65	18.11	19.19
Non-dairy cattle	Beef calves (<1 yr)	0.45	0.47	0.49	0.52	0.53	0.53	0.53	0.53	0.53	0.51	0.49
	Calfs M.Rep. (<1 yr)	1.09	1.11	1.12	1.14	1.16	1.18	1.19	1.21	1.22	1.20	1.18
	Calfs F Rep. (<1 yr)	0.93	0.95	0.95	0.97	0.98	1.00	1.01	1.02	1.04	1.03	1.01
	Males 1-2 yrs	4.15	4.14	4.12	4.10	3.97	3.89	3.82	3.78	3.74	3.61	3.47
	Beef Fem. 1-2 yrs	2.96	3.04	2.98	2.94	2.82	2.82	2.80	2.76	2.73	2.67	2.64
	Females rep. 1-2 yrs	2.99	3.03	3.00	2.97	2.88	2.87	2.83	2.81	2.79	2.71	2.62
	Steers (>2 yrs)	4.22	4.19	4.22	4.33	4.40	4.39	4.34	4.33	4.30	4.37	4.40
	Heifers Beef (>2 yrs)	3.37	3.26	3.14	3.07	2.93	2.84	2.70	2.72	2.73	2.75	2.79
	Heifers rep. (>2 yrs)	3.39	3.34	3.24	3.16	3.14	3.13	3.07	3.04	3.01	2.97	2.90
non-dairy cows	2.52	2.57	2.62	2.68	2.73	2.76	2.80	2.83	2.87	2.90	2.92	
Swine	Piglets (<20 kg)	1.22	1.22	1.22	1.22	1.22	1.22	1.22	1.22	1.22	1.22	1.23
	Fatt. Pigs (20-50 kg)	6.87	6.89	6.88	6.87	6.87	6.88	6.88	6.89	6.90	6.91	6.94
	Fatt. Pigs (50-80 kg)	10.03	10.08	10.06	10.10	10.11	10.13	10.15	10.14	10.14	10.14	10.17
	Fatt. Pigs (80-110 kg)	12.03	12.09	12.08	12.13	12.15	12.18	12.19	12.18	12.17	12.18	12.22
	Fatt. Pigs (> 110 kg)	13.21	13.31	13.30	13.38	13.39	13.41	13.38	13.38	13.38	13.39	13.48
	Boars (>50 kg)	13.25	13.21	13.23	13.18	13.19	13.22	13.24	13.30	13.34	13.35	13.27
	Sows, pregnant	12.94	12.91	12.86	12.83	12.82	12.84	12.83	12.84	12.83	12.84	12.86
	Sows, non-pregnant	26.46	26.32	26.28	26.37	26.50	26.54	26.49	26.50	26.49	26.51	26.57
Sheep	Sheep	0.41	0.41	0.41	0.41	0.40	0.40	0.40	0.39	0.39	0.39	0.38
Goats	Goats	0.32	0.31	0.31	0.31	0.31	0.31	0.30	0.30	0.30	0.30	0.30
Horses	Horses	3.77	3.70	3.63	3.56	3.49	3.42	3.33	3.25	3.16	3.10	3.03
Asses	Asses and Mules.	1.55	1.53	1.50	1.47	1.44	1.41	1.38	1.34	1.31	1.28	1.24
Poultry	Hens, reproductive	0.10	0.10	0.10	0.10	0.09	0.09	0.09	0.09	0.09	0.09	0.09
	Hens eggs	0.10	0.10	0.10	0.10	0.10	0.10	0.10	0.10	0.10	0.10	0.10
	Broilers	0.04	0.04	0.04	0.04	0.04	0.04	0.04	0.04	0.04	0.04	0.04
	Turkeys	0.20	0.20	0.20	0.20	0.20	0.20	0.20	0.20	0.20	0.20	0.20
	Other poultry	0.09	0.10	0.10	0.10	0.10	0.11	0.11	0.11	0.11	0.12	0.12
Other	Rabbits*	0.27	0.27	0.27	0.27	0.27	0.27	0.26	0.26	0.26	0.26	0.26



National Inventory Report - Portugal



Table C-4: Methane Emission Factors from Manure Management (kg.hd⁻¹.year⁻¹), by livestock category – complete time series

Type	Subtype	2001	2002	2003	2004	2005	2006	2007	2008	2009	2010	2011
Dairy cattle	Dairy cows	19.89	21.07	20.91	21.20	22.25	22.61	22.96	23.66	24.29	24.68	24.89
Non-dairy cattle	Beef calves (<1 yr)	0.48	0.47	0.47	0.47	0.46	0.45	0.43	0.42	0.40	0.39	0.37
	Calfs M.Rep. (<1 yr)	1.17	1.15	1.11	1.06	1.03	1.00	0.96	0.91	0.86	0.81	0.75
	Calfs F Rep. (<1 yr)	0.99	0.97	0.95	0.93	0.91	0.88	0.85	0.82	0.79	0.75	0.71
	Males 1-2 yrs	3.37	3.27	3.13	2.97	2.81	2.66	2.51	2.34	2.19	2.04	1.94
	Beef Fem. 1-2 yrs	2.61	2.51	2.43	2.35	2.20	2.05	1.91	1.81	1.71	1.63	1.60
	Females rep. 1-2 yrs	2.53	2.44	2.36	2.27	2.20	2.12	2.04	1.95	1.86	1.76	1.71
	Steers (>2 yrs)	4.45	4.40	4.35	4.27	4.21	4.13	4.07	3.98	3.90	3.83	3.84
	Heifers Beef (>2 yrs)	2.93	2.81	2.76	2.65	2.57	2.45	2.36	2.37	2.36	2.40	2.45
	Heifers rep. (>2 yrs)	2.84	2.82	2.79	2.78	2.73	2.68	2.62	2.58	2.55	2.50	2.49
	non-dairy cows	2.94	2.96	2.98	3.01	3.04	3.06	3.07	3.08	3.09	3.09	3.07
Swine	Piglets (<20 kg)	1.23	1.23	1.23	1.23	1.23	1.23	1.24	1.24	1.24	1.24	1.25
	Fatt. Pigs (20-50 kg)	6.96	6.98	7.00	7.02	7.03	7.03	7.03	7.03	7.05	7.07	7.08
	Fatt. Pigs (50-80 kg)	10.22	10.28	10.33	10.35	10.36	10.36	10.38	10.40	10.41	10.42	10.43
	Fatt. Pigs (80-110 kg)	12.30	12.37	12.40	12.40	12.39	12.40	12.42	12.48	12.52	12.56	12.57
	Fatt. Pigs (> 110 kg)	13.67	13.77	13.83	13.83	13.81	13.76	13.77	13.86	13.96	14.01	14.03
	Boars (>50 kg)	13.21	13.20	13.20	13.17	13.14	13.17	13.26	13.23	13.26	13.30	13.44
	Sows, pregnant	12.93	13.00	13.03	13.03	13.02	13.01	13.00	13.00	13.00	13.01	13.03
	Sows, non-pregnant	26.64	26.64	26.53	26.44	26.48	26.51	26.53	26.53	26.54	26.55	26.65
Sheep	Sheep	0.37	0.36	0.35	0.35	0.34	0.34	0.33	0.33	0.33	0.32	0.32
Goats	Goats	0.30	0.30	0.30	0.30	0.29	0.29	0.28	0.28	0.28	0.27	0.27
Horses	Horses	2.95	2.88	2.82	2.76	2.69	2.61	2.53	2.45	2.37	2.30	2.30
Asses	Asses and Mules.	1.21	1.18	1.15	1.13	1.10	1.08	1.05	1.02	0.98	0.93	0.90
Poultry	Hens, reproductive	0.09	0.09	0.09	0.09	0.09	0.09	0.09	0.09	0.09	0.09	0.09
	Hens eggs	0.10	0.10	0.10	0.10	0.10	0.10	0.10	0.10	0.10	0.10	0.10
	Broilers	0.04	0.04	0.04	0.04	0.04	0.04	0.04	0.04	0.04	0.04	0.04
	Turkeys	0.20	0.19	0.19	0.18	0.18	0.18	0.17	0.17	0.17	0.16	0.16
	Other poultry	0.13	0.13	0.13	0.14	0.14	0.14	0.15	0.15	0.16	0.17	0.17
Other	Rabbits*	0.26	0.26	0.26	0.26	0.26	0.26	0.26	0.25	0.25	0.25	0.25



National Inventory Report - Portugal



Table C-5: Methane Emission Factors from Manure Management (kg.hd⁻¹.year⁻¹), by livestock category – complete time series

Type	Subtype	2012	2013	2014	2015	2016	2017	2018	2019	2020	2021
Dairy cattle	Dairy cows	25.42	25.25	25.76	0.00	25.28	25.32	25.87	26.16	26.39	26.47
Non-dairy cattle	Beef calves (<1 yr)	0.35	0.33	0.32	0.00	0.33	0.33	0.32	0.32	0.32	0.32
	Calves M.Rep. (<1 yr)	0.70	0.64	0.64	0.00	0.64	0.65	0.65	0.65	0.65	0.65
	Calves F Rep. (<1 yr)	0.67	0.63	0.63	0.00	0.63	0.64	0.64	0.64	0.64	0.64
	Males 1-2 yrs	1.84	1.74	1.74	0.00	1.79	1.81	1.82	1.81	1.81	1.81
	Beef Fem. 1-2 yrs	1.58	1.53	1.53	0.00	1.51	1.50	1.51	1.52	1.54	1.55
	Females rep. 1-2 yrs	1.66	1.62	1.62	0.00	1.65	1.66	1.66	1.66	1.66	1.65
	Steers (>2 yrs)	3.85	3.87	3.90	0.00	3.94	3.96	3.99	4.00	4.01	4.00
	Heifers Beef (>2 yrs)	2.49	2.50	2.49	0.00	2.46	2.40	2.35	2.30	2.46	2.68
	Heifers rep. (>2 yrs)	2.47	2.47	2.47	0.00	2.53	2.58	2.62	2.63	2.63	2.62
	non-dairy cows	3.05	3.02	3.02	0.00	3.02	3.02	3.02	3.03	3.03	3.03
Swine	Piglets (<20 kg)	1.25	1.25	1.25	0.00	1.25	1.25	1.24	1.23	1.22	1.22
	Fatt. Pigs (20-50 kg)	7.10	7.12	7.13	0.00	7.13	7.14	7.07	7.02	6.95	6.95
	Fatt. Pigs (50-80 kg)	10.45	10.48	10.49	0.00	10.50	10.50	10.42	10.33	10.27	10.30
	Fatt. Pigs (80-110 kg)	12.59	12.59	12.60	0.00	12.60	12.60	12.51	12.41	12.35	12.35
	Fatt. Pigs (> 110 kg)	14.09	14.08	14.00	0.00	13.98	13.97	14.01	14.11	14.24	14.25
	Boars (>50 kg)	13.62	13.50	13.61	0.00	13.60	13.51	13.34	13.19	12.98	12.98
	Sows, pregnant	13.03	13.03	13.03	0.00	12.99	12.96	12.87	12.80	12.72	12.72
	Sows, non-pregnant	26.76	26.86	26.87	0.00	26.87	26.87	26.64	26.40	26.14	26.14
Sheep	Sheep	0.32	0.32	0.32	0.00	0.33	0.33	0.33	0.33	0.33	0.33
Goats	Goats	0.27	0.27	0.27	0.00	0.27	0.27	0.27	0.27	0.27	0.27
Horses	Horses	2.31	2.31	2.30	0.00	2.33	2.34	2.34	2.32	2.34	2.36
Asses	Asses and Mules.	0.90	0.91	0.90	0.00	0.92	0.94	0.93	0.92	0.90	0.90
Poultry	Hens, reproductive	0.09	0.09	0.09	0.00	0.09	0.09	0.09	0.08	0.08	0.08
	Hens eggs	0.10	0.10	0.09	0.00	0.09	0.09	0.09	0.09	0.09	0.09
	Broilers	0.04	0.04	0.04	0.00	0.04	0.04	0.04	0.04	0.04	0.04
	Turkeys	0.16	0.17	0.17	0.00	0.16	0.16	0.16	0.16	0.16	0.16
	Other poultry	0.16	0.16	0.16	0.00	0.17	0.17	0.16	0.15	0.14	0.14
Other	Rabbits*	0.25	0.25	0.25	0.00	0.25	0.26	0.25	0.25	0.25	0.25



National Inventory Report - Portugal



Table C-6: Total Nitrogen in manure produced by livestock in Portugal (t N.yr¹)

Type	1990	1991	1992	1993	1994	1995	1996	1997	1998	1999	2000
Dairy cattle	33 850	33 196	32 476	31 322	32 165	33 282	33 824	34 052	34 384	36 952	37 590
Non-dairy cattle	43 438	44 308	43 599	43 602	43 888	45 511	47 217	48 392	49 477	50 775	52 298
Sheep	25 391	25 809	25 910	26 037	26 474	26 837	27 154	27 006	27 213	27 444	26 943
Goats	5 279	5 149	4 983	4 824	4 703	4 614	4 535	4 480	4 409	4 301	4 077
Horses	1 447	1 666	1 750	1 842	1 953	2 094	2 272	2 396	2 485	2 527	2 563
Asses & Mules	2 599	2 560	2 513	2 499	2 393	2 273	2 104	1 969	1 812	1 658	1 517
Swine	26 055	27 093	27 064	27 217	26 701	26 132	24 977	24 816	24 653	24 618	23 786
Poultry	17 846	18 016	18 273	18 525	18 387	17 795	17 364	17 480	18 701	20 440	21 536
Rabbits*	4 273	4 172	4 022	3 872	3 733	3 605	3 452	3 263	3 113	3 041	3 023
Total	160 176	161 970	160 591	159 739	160 397	162 145	162 899	163 855	166 248	171 755	173 334

Type	2001	2002	2003	2004	2005	2006	2007	2008	2009	2010	2011
Dairy cattle	36 125	35 826	33 363	33 086	33 467	32 919	31 822	31 289	30 783	29 845	28 894
Non-dairy cattle	54 038	55 641	57 404	59 212	61 310	62 868	64 220	65 270	66 149	67 256	68 282
Sheep	25 236	23 318	22 269	22 275	22 567	22 623	22 056	21 089	19 977	18 826	17 794
Goats	3 678	3 327	3 060	3 016	3 041	3 094	3 004	2 898	2 793	2 758	2 717
Horses	2 597	2 611	2 611	2 611	2 640	2 713	2 845	3 139	3 623	4 063	4 297
Asses & Mules	1 383	1 335	1 327	1 349	1 320	1 261	1 166	983	726	521	418
Swine	22 485	20 858	19 650	19 285	19 190	19 248	19 183	19 131	19 114	18 836	18 696
Poultry	21 550	20 492	19 458	18 299	17 064	16 177	15 721	16 417	17 785	18 818	18 784
Rabbits*	2 984	2 923	2 862	2 754	2 599	2 429	2 290	2 256	2 294	2 295	2 184
Total	170 076	166 329	162 005	161 887	163 198	163 333	162 308	162 472	163 244	163 217	162 066

Type	2012	2013	2014	2015	2016	2017	2018	2019	2020	2021
Dairy cattle	28 329	27 689	27 532	27 760	27 982	28 173	28 053	27 844	27 676	27 557
Non-dairy cattle	69 532	70 408	71 033	72 758	75 474	77 877	79 004	80 049	80 703	80 935
Sheep	16 970	16 697	16 444	16 414	16 782	17 281	17 696	17 760	17 981	18 200
Goats	2 670	2 637	2 581	2 528	2 499	2 549	2 601	2 578	2 499	2 428
Horses	4 151	3 828	3 608	3 417	3 256	3 183	3 300	3 608	3 725	3 828
Asses & Mules	403	374	293	242	213	227	220	205	198	198
Swine	18 703	18 820	19 133	19 739	20 104	20 184	20 032	20 084	20 217	20 080
Poultry	17 721	16 691	16 361	16 765	17 863	19 807	22 543	26 119	28 486	29 679
Rabbits*	1 962	1 741	1 531	1 334	1 149	1 088	1 150	1 336	1 459	1 521
Total	160 442	158 885	158 516	160 957	165 322	170 369	174 599	179 582	182 946	184 427

*Per female cage



National Inventory Report - Portugal



Table C-7: Total amounts of Nitrogen (t N.yr-1) added to managed soils: activity data for direct N₂O emissions

Type	1990	1991	1992	1993	1994	1995	1996	1997	1998	1999	2000
Synthetic Fertilizer	158 500	158 500	158 500	158 500	158 500	145 815	168 229	164 288	149 303	148 944	170 009
Organic Fertilizer (manure)	61 042	61 165	60 146	59 188	58 361	57 570	56 134	55 315	55 257	56 777	56 544
Pasture	70 561	72 040	71 938	72 349	74 080	76 943	79 672	81 674	83 773	86 541	88 030
Crop Residues	52 292	47 212	42 321	41 124	42 627	45 953	44 611	45 340	44 740	44 430	43 934
Organic Fertilizer (other)	319	319	319	319	319	319	386	467	301	440	263
Total	342 714	339 237	333 224	331 481	333 887	326 601	349 031	347 083	333 374	337 132	358 780

Type	2001	2002	2003	2004	2005	2006	2007	2008	2009	2010	2011
Synthetic Fertilizer	157 511	163 902	141 408	178 851	102 663	87 391	113 005	105 131	97 293	100 249	95 088
Organic Fertilizer (manure)	54 377	51 892	48 902	47 468	46 453	45 230	43 847	43 423	43 452	42 907	42 321
Pasture	87 737	87 670	87 835	90 006	92 985	95 036	96 075	96 715	97 202	97 798	97 497
Crop Residues	43 345	42 106	42 357	40 519	39 777	38 301	38 627	38 169	37 467	36 419	41 449
Organic Fertilizer (other)	377	1 419	1 072	567	366	429	693	1 191	2 035	491	682
Total	343 347	346 989	321 574	357 412	282 244	266 385	292 247	284 630	277 449	277 864	277 037

Type	2012	2013	2014	2015	2016	2017	2018	2019	2020	2021
Synthetic Fertilizer	106 864	110 643	131 643	117 906	108 440	102 584	101 365	107 394	103 171	91 320
Organic Fertilizer (manure)	41 374	40 492	40 284	40 908	41 821	43 116	44 578	46 651	48 077	48 606
Pasture	97 472	97 430	97 443	98 898	101 656	104 369	105 868	107 104	107 921	108 386
Crop Residues	42 605	47 748	47 939	43 796	36 913	38 845	39 589	38 728	38 977	39 514
Organic Fertilizer (other)	1 087	1 246	489	1 648	1 381	929	584	1 309	1 963	1 267
Total	289 401	297 560	317 798	303 156	290 211	289 843	291 983	301 186	300 110	289 092



National Inventory Report - Portugal



Table C-8: Nitrogen consumption amount (t N.yr-1) by type of N fertilizer – time series activity data

Type	1990	1991	1992	1993	1994	1995	1996	1997	1998	1999	2000
Ammonium nitrate (AN)	-	-	-	-	-	-	-	-	-	-	-
Ammonium phosphate (MAP&DAP)	13 278	13 278	13 278	13 278	13 278	16 753	15 743	12 400	12 604	14 337	11 829
Ammonium sulphate (AS)	17 722	17 722	17 722	17 722	17 722	25 397	26 703	20 428	19 838	12 446	14 473
Calcium ammonia nitrate (CAN)	46 126	46 126	46 126	46 126	46 126	40 666	52 909	52 454	53 213	42 767	45 717
Urea	13 347	13 347	13 347	13 347	13 347	7 058	14 072	15 262	7 752	14 514	20 524
Other NK & NPK	49 540	49 540	49 540	49 540	49 540	40 762	42 544	43 449	36 292	46 446	57 742
Other N	18 488	18 488	18 488	18 488	18 488	15 180	16 258	20 295	19 604	18 435	19 725
Total	158 500	158 500	158 500	158 500	158 500	145 815	168 229	164 288	149 303	148 944	170 009

Type	2001	2002	2003	2004	2005	2006	2007	2008	2009	2010	2011
Ammonium nitrate (AN)	-	-	-	-	-	-	-	-	4 295	4 009	4 182
Ammonium phosphate (MAP&DAP)	10 521	12 038	9 097	1 920	-	-	-	-	1 013	539	209
Ammonium sulphate (AS)	10 917	11 575	10 310	10 273	10 298	4 221	5 864	2 541	1 951	3 057	-
Calcium ammonia nitrate (CAN)	38 776	42 505	35 892	43 305	29 682	19 206	34 634	26 751	27 179	34 989	23 487
Urea	17 527	10 066	9 235	8 203	11 849	20 447	21 976	26 008	24 064	13 854	22 193
Other NK & NPK	59 095	69 986	61 915	96 642	39 937	33 758	41 105	28 972	16 086	24 905	24 943
Other N	20 675	17 731	14 959	18 508	10 897	9 759	9 426	20 859	22 705	18 896	20 074
Total	157 511	163 902	141 408	178 851	102 663	87 391	113 005	105 131	97 293	100 249	95 088

Type	2012	2013	2014	2015	2016	2017	2018	2019	2020	2021
Ammonium nitrate (AN)	3 696	7 700	4 635	670	850	406	6	20	359	359
Ammonium phosphate (MAP&DAP)	1 371	2 042	1 172	576	1 942	2 457	2 496	1 594	1 793	1 793
Ammonium sulphate (AS)	-	-	1 202	1 805	1 912	1 711	688	2 507	556	556
Calcium ammonia nitrate (CAN)	17 620	25 380	18 553	17 889	21 764	16 521	19 931	19 608	21 569	21 569
Urea	20 883	15 567	25 402	30 518	30 203	25 846	21 816	13 840	15 176	15 176
Other NK & NPK	17 193	24 568	31 865	27 969	24 887	24 798	23 910	28 300	27 876	27 876
Other N	46 101	35 387	48 814	38 480	26 883	30 845	32 519	39 631	38 000	38 000
Total	106 864	110 643	131 643	117 906	108 440	102 584	101 365	105 499	105 330	105 330



Annex D: Waste Background Data Tables

Updated: March 2023

Table D-1: National population, waste generation per capita, and municipal waste generation (including waste amounts sent to material recycling)

Year	Population	Annual per capita generation rate	Pop. served by collection syst.	Municipal waste generation					
				Total	of which: Open dump sites	Managed landfills	Composted	Anaerobic digestion	Incinerated
	inhabitants	kg/inh/year	% pop.	kton					
1960	8,889,197	51.5	40	457.8	457.8	0.0	0.0	0.0	0.0
1961	8,861,388	54.4	41	482.4	482.4	0.0	0.0	0.0	0.0
1962	8,833,580	57.5	42	507.8	507.8	0.0	0.0	0.0	0.0
1963	8,805,771	60.7	44	534.1	534.1	0.0	0.0	0.0	0.0
1964	8,777,962	64.0	45	561.4	561.4	0.0	0.0	0.0	0.0
1965	8,750,154	67.4	46	589.6	589.6	0.0	0.0	0.0	0.0
1966	8,722,345	70.9	47	618.8	618.8	0.0	0.0	0.0	0.0
1967	8,694,536	74.7	48	649.1	649.1	0.0	0.0	0.0	0.0
1968	8,666,727	78.5	50	680.4	680.4	0.0	0.0	0.0	0.0
1969	8,638,919	82.5	51	712.8	712.8	0.0	0.0	0.0	0.0
1970	8,611,110	86.7	52	746.3	746.3	0.0	0.0	0.0	0.0
1971	8,722,192	91.1	53	794.5	794.5	0.0	0.0	0.0	0.0
1972	8,833,274	95.7	54	845.2	845.2	0.0	0.0	0.0	0.0
1973	8,944,357	100.5	56	898.5	898.5	0.0	0.0	0.0	0.0
1974	9,055,439	105.4	57	954.5	954.5	0.0	0.0	0.0	0.0
1975	9,166,521	110.5	58	1,013.4	1,013.4	0.0	0.0	0.0	0.0
1976	9,277,603	115.9	59	1,075.1	1,075.1	0.0	0.0	0.0	0.0
1977	9,388,685	121.4	60	1,140.0	1,140.0	0.0	0.0	0.0	0.0
1978	9,499,767	127.2	62	1,208.1	1,208.1	0.0	0.0	0.0	0.0
1979	9,610,850	133.1	63	1,279.5	1,279.5	0.0	0.0	0.0	0.0
1980	9,721,932	139.3	64	1,354.4	949.2	360.5	44.7	0.0	0.0
1981	9,833,014	148.7	66	1,462.0	1,021.1	396.2	44.7	0.0	0.0
1982	9,836,427	158.4	68	1,558.2	1,088.1	425.4	44.7	0.0	0.0
1983	9,839,841	168.6	71	1,658.9	1,158.2	456.0	44.7	0.0	0.0
1984	9,843,254	179.3	73	1,764.5	1,231.7	488.1	44.7	0.0	0.0
1985	9,846,667	190.4	75	1,875.0	1,308.6	521.7	44.7	0.0	0.0
1986	9,850,081	203.2	78	2,001.1	1,396.3	560.1	44.7	0.0	0.0
1987	9,853,494	216.5	80	2,133.2	1,488.2	600.3	44.7	0.0	0.0
1988	9,856,907	230.5	83	2,271.7	1,584.5	642.5	44.7	0.0	0.0
1989	9,860,320	245.1	85	2,416.8	1,685.4	686.7	44.7	0.0	0.0
1990	9,863,734	260.4	88	2,568.7	1,779.3	739.2	50.3	0.0	0.0
1991	9,867,147	272.7	89	2,690.9	1,734.5	906.1	50.3	0.0	0.0
1992	9,916,044	285.5	91	2,831.4	1,824.4	956.7	50.3	0.0	0.0
1993	9,964,941	298.9	92	2,978.4	1,918.6	1,009.6	50.3	0.0	0.0
1994	10,013,838	312.8	93	3,132.3	1,865.1	1,179.4	87.8	0.0	0.0
1995	10,062,735	332.0	95	3,341.2	1,982.4	1,248.5	110.4	0.0	0.0
1996	10,111,632	350.4	96	3,542.8	2,058.3	1,373.6	110.8	0.0	0.0
1997	10,160,529	368.9	97	3,748.6	2,038.6	1,596.1	113.8	0.0	0.0
1998	10,209,426	387.8	98	3,958.7	1,539.9	2,302.1	116.8	0.0	0.0
1999	10,258,323	425.3	99	4,363.2	975.1	2,736.9	114.9	0.0	346.4
2000	10,307,220	439.5	100	4,530.3	588.8	2,610.5	137.4	0.0	911.1
2001	10,356,117	446.0	100	4,618.5	460.1	2,912.1	139.2	0.0	891.7
2002	10,444,592	457.0	100	4,772.8	27.8	3,490.6	75.5	0.0	943.9
2003	10,473,050	464.6	100	4,865.7	25.9	3,367.4	232.5	0.0	1,003.4



Year	Population	Annual capita generation rate	Pop. served by collection syst.	Municipal waste generation					
				Total	of which: Open dump sites	Managed landfills	Composted	Anaerobic digestion	Incinerated
	inhabitants	kg/inh/year	% pop.	kton					
2004	10,494,672	435.9	100	4,575.0	22.3	3,206.1	129.0	0.0	994.2
2005	10,511,988	436.3	100	4,586.4	0.0	3,128.4	130.7	0.0	1,057.0
2006	10,532,588	447.1	100	4,708.9	0.0	3,264.5	129.5	3.8	984.4
2007	10,553,339	455.4	100	4,806.4	0.0	3,233.3	131.0	12.5	954.5
2008	10,563,014	496.3	100	5,242.4	0.0	3,530.2	170.7	14.6	993.0
2009	10,573,479	497.2	100	5,256.9	0.0	3,351.1	205.8	10.4	1,082.6
2010	10,572,721	524.0	100	5,540.3	0.0	3,682.6	219.2	12.9	1,092.2
2011	10,542,398	497.0	100	5,239.6	0.0	3,395.3	200.7	43.3	1,131.5
2012	10,487,289	457.4	100	4,797.1	0.0	2,920.9	205.3	127.4	1,034.3
2013	10,427,301	441.9	100	4,607.4	0.0	2,601.9	182.6	167.1	1,117.8
2014	10,374,822	454.9	100	4,720.0	0.0	2,532.1	173.8	315.8	1,051.9
2015	10,341,330	459.1	100	4,747.2	0.0	2,429.0	190.8	200.0	1,129.2
2016	10,309,573	474.4	100	4,891.0	0.0	2,536.4	347.0	457.0	1,198.8
2017	10,291,027	486.5	100	5,006.5	0.0	2,852.8	394.5	445.1	1,183.3
2018	10,276,617	507.3	100	5,213.1	0.0	2,935.5	347.0	508.9	1,128.8
2019	10,295,909	513.0	100	5,281.4	0.0	2,944.4	326.0	521.8	1,190.2
2020	10,298,252	512.6	100	5,278.8	0.0	3,124.4	268.4	415.8	1,144.4
2021	10,344,802	513.4	100	5,310.5	0.0	2,967.5	341.4	518.1	1,244.4

Sources:INE; APA (include estimates); Quercus Study

Table D-2: MSW waste incinerated (accounted CRF 1A1a)

Year	Quantities incinerated		Emissions	
	Biogenic	Non-biogenic	Biogenic	Non-biogenic
	kton		kton CO ₂ e.	
< 1999	-	-	-	-
1999	219.8	126.6	196.3	113.1
2000	578.0	333.1	516.2	297.5
2001	565.7	326.0	505.2	291.1
2002	598.8	345.1	534.8	308.2
2003	636.6	366.8	568.5	327.6
2004	630.7	363.4	563.3	324.6
2005	670.6	386.4	598.9	345.1
2006	624.5	359.9	557.7	321.4
2007	605.6	349.0	540.8	311.7
2008	629.9	363.0	562.6	324.2
2009	686.8	395.8	613.4	353.5
2010	692.9	399.3	618.8	356.6
2011	702.9	428.7	630.4	384.5
2012	647.7	386.6	593.4	354.2
2013	691.1	426.7	627.0	387.1
2014	608.8	443.2	565.2	411.4
2015	672.7	456.5	638.1	433.1
2016	678.3	520.5	633.8	486.4
2017	649.5	533.7	619.1	508.7
2018	620.0	508.9	588.6	483.1
2019	675.7	514.5	616.0	469.1
2020	640.5	504.0	608.4	478.8
2021	743.4	501.0	622.6	419.6

Source: APA.



Table D-3: Fermentable industrial waste disposal

Year	Open dump sites	Managed landfills	Year	Open dump sites	Managed landfills	Year	Open dump sites	Managed landfills
	kton			kton			kton	
1960	711.9	0.0	1981	701.2	272.0	2002	5.9	748.0
1961	722.6	0.0	1982	710.2	277.6	2003	5.2	679.0
1962	733.4	0.0	1983	719.4	283.2	2004	4.2	601.9
1963	744.4	0.0	1984	728.8	288.8	2005	0.0	528.0
1964	755.6	0.0	1985	738.5	294.4	2006	0.0	449.9
1965	766.9	0.0	1986	748.3	300.1	2007	0.0	371.8
1966	778.4	0.0	1987	758.3	305.9	2008	0.0	293.7
1967	790.1	0.0	1988	768.5	311.6	2009	0.0	250.5
1968	801.9	0.0	1989	778.9	317.4	2010	0.0	225.6
1969	814.0	0.0	1990	786.1	326.6	2011	0.0	273.9
1970	826.2	0.0	1991	745.5	389.5	2012	0.0	235.7
1971	838.6	0.0	1992	759.4	398.2	2013	0.0	187.7
1972	851.1	0.0	1993	773.7	407.1	2014	0.0	168.4
1973	863.9	0.0	1994	737.9	466.6	2015	0.0	164.1
1974	876.9	0.0	1995	753.8	474.7	2016	0.0	192.2
1975	890.0	0.0	1996	751.6	501.6	2017	0.0	168.7
1976	903.4	0.0	1997	716.9	561.3	2018	0.0	183.4
1977	916.9	0.0	1998	522.5	781.2	2019	0.0	203.0
1978	916.9	0.0	1999	349.3	980.5	2020	0.0	202.1
1979	944.6	0.0	2000	209.4	928.4	2021	0.0	193.3
1980	694.9	263.9	2001	129.1	816.8	-	-	-

Notes:

Share between open dump and managed landfills based on disposal of municipal solid wastes.

2002 to 2004: disposal on open dump sites refer to disposal on controlled dump sites.

Source: APA (include estimates)

Table D-4: Composted waste: Non-Municipal waste

	Non-Municipal waste composted waste
	kton
< 2012	-
2013	34.3
2014	71.9
2015	122.2
2016	134.4
2017	210.2
2018	403.4
2019	416.4
2020	268.0
2021	342.2

Source: APA

**Table D-5: Quantities of waste incinerated (accounted CRF 5C)**

Year	Clinical waste quantities incinerated		Industrial solid waste incinerated	
	Quantities	Emissions	Quantities	Emissions
	kton	kton CO2 e.	kton	kton CO2 e.
1990	12.1	4.7	24.0	3.4
1991	12.1	4.7	24.5	3.5
1992	12.1	4.7	25.0	3.6
1993	12.1	4.7	25.5	3.7
1994	12.1	4.7	26.0	3.7
1995	12.1	4.7	26.5	3.8
1996	13.5	5.3	27.0	3.9
1997	15.7	6.1	27.6	4.0
1998	11.8	4.6	28.1	4.0
1999	10.4	4.1	28.7	4.1
2000	7.1	2.8	31.5	3.7
2001	3.2	1.3	34.4	2.8
2002	2.8	1.1	37.2	1.6
2003	2.3	0.9	47.3	8.0
2004	1.8	0.7	47.6	11.7
2005	1.2	0.5	47.9	12.8
2006	0.7	0.3	48.2	13.9
2007	2.8	1.1	48.5	15.1
2008	3.2	1.3	48.8	5.8
2009	3.2	1.3	29.5	17.8
2010	3.8	1.5	21.1	15.8
2011	1.9	0.7	23.8	14.3
2012	1.3	0.5	31.1	16.0
2013	1.1	0.4	20.3	22.7
2014	0.9	0.3	21.6	26.2
2015	0.6	0.2	19.0	24.6
2016	1.2	0.5	22.1	24.1
2017	1.3	0.5	26.7	26.6
2018	5.2	2.0	25.3	30.9
2019	5.8	2.3	26.4	26.2
2020	8.9	3.5	25.0	31.1
2021	8.3	3.3	21.5	34.6

Note: Estimates in italics

Sources: APA; DGS

**Table D-6: Quantities of CH₄ recovered and combusted (SWDS)**

	Biogas burned	Biogas burned	Biogas burned as % of
	kton CH ₄	kton CO ₂ eq.	CH ₄ generated in SWDS
1990	-	-	-
1991	-	-	-
1992	-	-	-
1993	-	-	-
1994	-	-	-
1995	-	-	-
1996	-	-	-
1997	-	-	-
1998	-	-	-
1999	-	-	-
2000	-	-	-
2001	-	-	-
2002	-	-	-
2003	-	-	-
2004	2	61	1.5
2005	11	306	7.4
2006	15	412	9.4
2007	19	527	11.5
2008	24	666	13.8
2009	26	729	14.3
2010	32	889	16.4
2011	32	890	15.9
2012	38	1,069	18.6
2013	39	1,104	18.8
2014	40	1,110	18.5
2015	44	1,233	20.4
2016	41	1,155	19.0
2017	39	1,079	17.7
2018	35	991	16.3
2019	32	888	14.6
2020	33	927	15.3
2021	31	875	14.4

Source: APA and DGEG data.



Table D-7: National population and wastewater BOD produced by handling systems

	Population (1000 inhabitants)	BOD5 produced (kton/year)					
		Total	Treatment systems		Individual treatment	Without treatment	Sludge accounted in other pathways
			wastewater	sludge			
1990	9,864	216	24	5	8	173	5
1991	9,867	216	25	5	12	168	5
1992	9,916	217	26	6	15	164	6
1993	9,965	218	27	6	19	160	6
1994	10,014	219	29	6	23	155	6
1995	10,063	220	34	8	27	144	8
1996	10,112	221	40	9	31	132	9
1997	10,161	223	45	10	36	121	11
1998	10,209	224	51	12	40	109	12
1999	10,258	225	57	13	44	97	14
2000	10,307	226	63	14	49	84	15
2001	10,356	227	69	16	55	71	17
2002	10,445	229	75	17	60	58	19
2003	10,473	229	81	19	65	44	21
2004	10,495	230	87	20	70	31	22
2005	10,512	230	93	22	75	17	24
2006	10,533	231	101	22	72	14	23
2007	10,553	231	107	21	65	16	22
2008	10,563	231	113	20	58	19	22
2009	10,573	232	118	19	56	19	20
2010	10,573	232	117	20	55	16	22
2011	10,542	231	117	22	54	14	24
2012	10,487	230	117	23	51	12	27
2013	10,427	228	118	25	47	9	29
2014	10,375	227	117	26	45	7	32
2015	10,341	226	120	28	38	3	37
2016	10,310	226	120	28	38	3	36
2017	10,291	225	120	28	38	3	36
2018	10,277	225	119	28	37	3	37
2019	10,296	225	119	28	37	3	37
2020	10,298	226	120	28	37	3	38
2021	10,345	227	120	28	37	3	38

Notes:

Treatment systems – wastewater: refer to primary treatment (70% of organic load), Biodisks with and without anaerobic sludge digestion, Activated sludge with and without anaerobic sludge digestion, Lagoons without anaerobic pond, Percolation beds with anaerobic sludge digestion, Oxidation ponds and Other treatment (63% of organic load); Preliminary treatment, Treatment not specified, Lagoon, with anaerobic pond and Imhoff Tanks (100% of organic load).

Treatment systems – sludge: refer to Biodisks with anaerobic sludge digestion, Activated sludge with anaerobic sludge digestion, Percolation beds with anaerobic sludge digestion, Oxidation ponds, Other treatment (37% of organic load) and unspecified treatment.

Individual treatment: refer to wastewater not collected by a public system. It's assumed that the population has a private handling system (private septic tanks).

Without treatment: refer to wastewater collected but not treated, referring to discharges into the ocean, inland waters, soil, and unknown disposal type.

Sludge accounted in other pathways (agricultural recovery, energy recovery, landfill and composting): refer to the % of the organic load retained as non-mineralised sludge in primary treatment (30% of primary organic load generated), and 37% in activated sludge without anaerobic sludge digestion, lagoons without anaerobic pond, Percolation beds without anaerobic sludge digestion, oxidation ponds and other treatment.

Source: APA (estimates).

**Table D-8: Quantities of CH₄ combusted from municipal and industrial wastewater handling systems**

Year	Municipal treatment systems			Industrial treatment systems	
	kton CH ₄ /year	% emissions of total emissions generated	% sludge anaerobic treat. emissions generated	kton CH ₄ /year	% emissions of total emissions generated
1990	-	-	-	-	-
1991	-	-	-	-	-
1992	-	-	-	-	-
1993	-	-	-	-	-
1994	-	-	-	-	-
1995	-	-	-	-	-
1996	-	-	-	-	-
1997	-	-	-	-	-
1998	-	-	-	-	-
1999	-	-	-	-	-
2000	0.7	1.6	9.6	0.0	0.3
2001	0.3	0.8	4.7	0.1	1.2
2002	0.4	0.9	4.8	0.2	1.5
2003	0.2	0.6	2.8	0.2	1.4
2004	0.6	1.5	6.8	0.2	1.9
2005	0.9	2.1	8.6	0.2	1.7
2006	0.8	1.9	7.7	0.3	2.0
2007	0.7	1.7	6.9	0.3	2.3
2008	0.6	1.7	6.8	0.4	3.2
2009	1.2	3.2	13.1	0.4	3.4
2010	1.3	3.6	13.4	0.2	1.4
2011	1.4	4.2	14.1	0.2	1.6
2012	1.4	4.2	12.8	0.2	1.5
2013	2.2	7.1	18.9	0.0	0.1
2014	2.2	7.5	17.9	0.1	0.6
2015	2.1	8.0	15.6	0.4	2.5
2016	2.2	8.4	16.3	0.3	2.7
2017	2.4	9.2	17.9	0.4	4.0
2018	4.9	18.8	36.3	0.6	6.2
2019	5.1	19.7	38.0	1.1	11.3
2020	5.5	21.3	40.9	2.1	21.5
2021	5.8	22.6	43.4	2.5	24.7

Source: DGEG data



Annex E: Key Category Analysis

Updated: March 2023

E.1 Introduction

This chapter provides an analysis of key categories following recommendations of the 2006 IPCC Guidelines. A key category (source or sink) “is one that is prioritised within the national inventory system because its estimate has a significant influence on a country’s total inventory of direct greenhouse gases in terms of the absolute level of emissions, the trend in emissions, or both.” The aim of defining key categories is the improvement of the inventory’s accuracy. As key categories are the most important sources or removals in terms of their contribution to the absolute level of national emissions, the identification of these categories enables the prioritisation of national efforts and a more efficient use of available resources in order to reach an improvement of national estimates. Information on key categories is also important for the development of policies and measures for emissions reduction.

The methods purposed by the 2006 IPCC Guidelines for performing key category analysis, include:

- Tier 1 approach (level and trend assessments);
- Tier 2 approach (level and trend assessments with uncertainty analysis);
- Qualitative approach.

E.2 Methodology for key category identification: Portuguese inventory

Having as a basis the 2022 Portuguese inventory estimates (1990-2021), the determination of key categories was conducted using Approach 1 and Approach 2 with and without the LULUCF sector.

In accordance with the recommendations from the last UNFCCC review, the disaggregation level of the key category analysis has been revised in order to follow the guidance from 2006 IPCC.

Level assessment was undertaken for the base year and the latest reported inventory year; the trend assessment was performed for the 1990-2021 period. The analysis performed without LULUCF resulted in the identification of 37 key categories. Including the LULUCF sector in the analysis, 46 categories were identified.

E.3 Presentation of results

Key category analysis can be very influenced by the definitions of source categories (extent of the split). If a large category is broken into many subcategories, then these subcategories may not have a significant contribution to the total inventory to be considered as a key source. On the opposite, several non-key sources categories may become key source categories if aggregated into a unique source category.

In a general way, the source and removal categories have been split according to the disaggregation level proposed by the 2016 IPCC.

For this submission the analysis was based on the application of Approach 1 and Approach 2 with and without the LULUCF sector as mentioned before.

Without LULUCF, the analysis resulted in the identification of 37 key categories. Including the LULUCF sector 46 categories were identified.

Table E.1 presents a summary of identified key categories for 1990-2021 without LULUCF using both approaches, and the criteria used (level, trend) in the identification. Table E.2 presents a summary of identified key categories for 1990-2021 with LULUCF.



Table E-1: Overview of key categories (without LULUCF) using Approach 1 and 2 for the base and latest inventory year

IPCC CATEGORIES	GHG	Key source Category Flag	Criteria for Identification	Current year emissions (kton CO2 eq.)
1.A.3.b Road Transportation	CO2	✓	Level 1 and 2, Trend 1 and 2	15,174.7
1.A.1 Energy industries - Gaseous fuels	CO2	✓	Level 1 and 2, Trend 1 and 2	5,429.7
1.A.2 Manufacturing industries and construction - Gaseous fuels	CO2	✓	Level 1, Trend 1 and 2	4,167.2
3.A Enteric fermentation	CH4	✓	Level 1, Trend 1	4,063.9
5.A Solid waste disposal	CH4	✓	Level 1 and 2, Trend 1 and 2	3,855.6
2.F.1 Refrigeration and Air Conditioning	Fgases	✓	Level 1 and 2	3,018.9
1.A.2 Manufacturing industries and construction - Liquid fuels	CO2	✓	Level 1 and 2, Trend 1 and 2	2,637.0
1.A.4 Combustion Other Sectors - Liquid fuels	CO2	✓	Level 1, Trend 1	2,591.3
2.A.1 Mineral Industry - Cement production	CO2	✓	Level 1 and 2, Trend 1 and 2	2,105.9
1.A.1 Energy industries - Liquid fuels	CO2	✓	Level 1 and 2, Trend 1 and 2	1,562.4
3.D.1 Direct N2O Emissions From Managed Soils	N2O	✓	Level 1 and 2	1,551.6
1.A.4 Combustion Other Sectors - Gaseous fuels	CO2	✓	Level 1, Trend 1	1,424.4
3.B Manure Management	CH4	✓	Level 1	838.3
1.B.2.a Fugitive emissions - Oil	CO2	✓	Level 1 and 2, Trend 1 and 2	819.2
5.D Wastewater treatment and discharge	CH4	✓	Level 1 and 2, Trend 1 and 2	769.1
1.A.1 Energy industries - Solid fuels	CO2	✓	Level 1 and 2, Trend 1 and 2	690.6
2.B.8 Chemical Industry - Petrochemical and Carbon Black production	CO2	✓	Level 1 and 2	637.5
1.A.1 Energy industries - Other fossil fuels	CO2	✓	Level 1 and 2, Trend 1 and 2	409.7
3.D.2 Indirect N2O Emissions From Managed Soils	N2O	✓	Level 1	387.4
2.A.2 Mineral Industry - Lime production	CO2	✓	Level 1 and 2, Trend 2	386.6
1.A.3.a Civil (domestic) aviation	CO2	✓	Level 1 and 2, Trend 2	340.1
1.A.2 Manufacturing industries and construction - Other fossil fuels	CO2	✓	Level 1, Trend 2	304.9
2.A.4 Mineral Industry - Other Process Uses of Carbonates	CO2	✓	Level 1	258.3
1.A.4 Combustion Other Sectors - Biomass	CH4	✓	Level 1	236.6
1.A.3.d Domestic navigation - Residual fuel oil	CO2	✓	Level 2	207.1
2.D Non-energy products from fuels and solvent use	CO2	✓	Level 2	205.2
3.C Rice cultivation	CH4	✓	Level 2	175.8
5.D Wastewater treatment and discharge	N2O	✓	Level 2	168.5
5.B Biological treatment of solid waste	CH4	✓	Level 2, Trend 2	88.2
1.A.1 Energy industries - Gaseous fuels	N2O	✓	Trend 2	65.0
2.C.1 Metal Industry - Iron and Steel production	CO2	✓	Level 1, Trend 1 and 2	65.0
1.B.2.b Fugitive emissions - Natural Gas	CH4	✓	Level 2, Trend 2	58.6
1.A.2 Manufacturing industries and construction - Solid fuels	CO2	✓	Level 1 and 2, Trend 1 and 2	56.4
5.B Biological treatment of solid waste	N2O	✓	Trend 2	43.5
5.C Incineration and open burning of waste	CO2	✓	Level 2, Trend 2	36.9
2.B.2 Chemical Industry - Nitric acid production	N2O	✓	Level 1, Trend 1	33.2
1.B.1.Fugitive emissions – Solid Fuels	CH4	✓	Level 2, Trend 2	17.0



Table E-2: Overview of key categories (with LULUCF) using Approach 1 and 2 for the base and latest inventory year

	GHG	Key source Category Flag	Criteria for Identification	Current year emissions (kton CO2 eq.)
1.A.3.b Road Transportation	CO2	√	Level 1 and 2, Trend 1 and 2	15,174.7
1.A.1 Energy industries - Gaseous fuels	CO2	√	Level 1, Trend 1 and 2	5,429.7
1.A.2 Manufacturing industries and construction - Gaseous fuels	CO2	√	Level 1, Trend 1	4,167.2
3.A Enteric fermentation	CH4	√	Level 1, Trend 1	4,063.9
5.A Solid waste disposal	CH4	√	Level 1 and 2, Trend 1 and 2	3,855.6
2.F.1 Refrigeration and Air Conditioning	Fgases	√	Level 1 and 2	3,018.9
1.A.2 Manufacturing industries and construction - Liquid fuels	CO2	√	Level 1 and 2, Trend 1 and 2	2,637.0
1.A.4 Combustion Other Sectors - Liquid fuels	CO2	√	Level 1	2,591.3
2.A.1 Mineral Industry - Cement production	CO2	√	Level 1 and 2, Trend 1	2,105.9
1.A.1 Energy industries - Liquid fuels	CO2	√	Level 1 and 2, Trend 1 and 2	1,562.4
3.D.1 Direct N2O Emissions From Managed Soils	N2O	√	Level 1 and 2, Trend 1 and 2	1,551.6
1.A.4 Combustion Other Sectors - Gaseous fuels	CO2	√	Level 1, Trend 1	1,424.4
3.B Manure Management	CH4	√	Level 1	838.3
1.B.2.a Fugitive emissions - Oil	CO2	√	Level 1 and 2, Trend 1 and 2	819.2
5.D Wastewater treatment and discharge	CH4	√	Level 1 and 2, Trend 1 and 2	769.1
1.A.1 Energy industries - Solid fuels	CO2	√	Level 1 and 2, Trend 1 and 2	690.6
2.B.8 Chemical Industry - Petrochemical and Carbon Black production	CO2	√	Level 1	637.5
1.A.1 Energy industries - Other fossil fuels	CO2	√	Level 1 and 2, Trend 1 and 2	409.7
3.D.2 Indirect N2O Emissions From Managed Soils	N2O	√	Level 1	387.4
2.A.2 Mineral Industry - Lime production	CO2	√	Level 1 and 2, Trend 1 and 2	386.6
4(IV) Indirect nitrous oxide (N2O)	N2O	√	Level 1	385.5
4.D.2 Land converted to Wetlands	CO2	√	Level 1	371.3
1.A.3.a Civil (domestic) aviation	CO2	√	Level 1 and 2	340.1
1.A.2 Manufacturing industries and construction - Other fossil fuels	CO2	√	Level 1, Trend 1	304.9
2.A.4 Mineral Industry - Other Process Uses of Carbonates	CO2	√	Level 1	258.3
4.B.2 Land converted to Cropland	CO2	√	Level 1 and 2	247.5
1.A.4 Combustion Other Sectors - Biomass	CH4	√	Level 1	236.6
2.D Non-energy products from fuels and solvent use	CO2	√	Level 2	205.2
4.A.1. Forest land remaining Forest land	CH4	√	Level 1	196.5
3.C Rice cultivation	CH4	√	Level 2	175.8
5.D Wastewater treatment and discharge	N2O	√	Level 2, Trend 2	168.5
4.E.2 Land converted to Settlements	CO2	√	Level 1 and 2, Trend 2	95.7
5.B Biological treatment of solid waste	CH4	√	Level 2, Trend 2	88.2
2.C.1 Metal Industry - Iron and Steel production	CO2	√	Level 1, Trend 1	65.0
1.B.2.b Fugitive emissions - Natural Gas	CH4	√	Level 2, Trend 2	58.6
1.A.2 Manufacturing industries and construction - Solid fuels	CO2	√	Level 1, Trend 1	56.4
5.C Incineration and open burning of waste	CO2	√	Level 2	36.9
4.C.1. Grassland remaining Grassland	CH4	√	Level 2	36.9
2.B.2 Chemical Industry - Nitric acid production	N2O	√	Level 1, Trend 1	33.2
1.B.1.Fugitive emissions – Solid Fuels	CH4	√	Level 2, Trend 2	17.0
4.G. Other (Harvested Wood Products)	CO2	√	Level 1, Trend 1	-253.1
4.C.2 Land converted to Grassland	CO2	√	Level 1 and 2, Trend 1 and 2	-677.5
4.A.1. Forest land remaining Forest land	CO2	√	Level 1 and 2, Trend 1 and 2	-877.3
4.A.2 Land converted to Forest land	CO2	√	Level 1 and 2, Trend 1	-1,663.0
4.B.1. Cropland remaining Cropland	CO2	√	Level 1 and 2, Trend 1 and 2	-1,914.3
4.C.1. Grassland remaining Grassland	CO2	√	Level 1 and 2, Trend 1 and 2	-2,203.3

The following tables E.3 to E.8, present the two approaches without LULUCF categories for the base year and the latest reported inventory year for level assessment and trend assessment for 1990-2021.

Tables E.9 to E.14, present the two approaches with LULUCF categories for the base year and the latest reported inventory year for level assessment and trend assessment for 1990-2021.



Table E-3: Level assessment (Approach 1) without LULUCF: 1990

Tier 1 Level Assessment (1990)						
IPCC SOURCE CATEGORIES	GHG	Base year Estimate (kton CO ₂ eq.) 1990	Current year Estimate (kton CO ₂ eq.) 1990	Level Assess.	Cumulative Total	
1A.3.b Road Transportation	CO ₂	10,001	10,001	0.17	0.17	
1A.1 Energy industries - Liquid fuels	CO ₂	8,354	8,354	0.14	0.31	
1A.1 Energy industries - Solid fuels	CO ₂	8,011	8,011	0.13	0.44	
1A.2 Manufacturing industries and construction - Liquid fuels	CO ₂	6,531	6,531	0.11	0.55	
3.A Enteric fermentation	CH ₄	3,943	3,943	0.07	0.62	
1A.4 Combustion Other Sectors - Liquid fuels	CO ₂	3,463	3,463	0.06	0.68	
2.A.1 Mineral Industry - Cement production	CO ₂	3,176	3,176	0.05	0.73	
5.A Solid waste disposal	CH ₄	3,159	3,159	0.05	0.78	
1A.2 Manufacturing industries and construction - Solid fuels	CO ₂	2,311	2,311	0.04	0.82	
5.D Wastewater treatment and discharge	CH ₄	1,699	1,699	0.03	0.85	
3.D.1 Direct N ₂ O Emissions From Managed Soils	N ₂ O	1,600	1,600	0.03	0.88	
3.B Manure Management	CH ₄	907	907	0.02	0.89	
2.B.1 Chemical Industry - Ammonia production	CO ₂	763	763	0.01	0.91	
2.B.8 Chemical Industry - Petrochemical and Carbon Black production	CO ₂	645	645	0.01	0.92	
1A.4 Combustion Other Sectors - Biomass	CH ₄	476	476	0.01	0.93	
2.B.2 Chemical Industry - Nitric acid production	N ₂ O	460	460	0.01	0.93	
2.C.1 Metal Industry - Iron and Steel production	CO ₂	440	440	0.01	0.94	
3.D.2 Indirect N ₂ O Emissions From Managed Soils	N ₂ O	439	439	0.01	0.95	

Table E-4: Level assessment (Approach 1) without LULUCF: latest inventory year

Tier 1 Level Assessment (2021)						
IPCC SOURCE CATEGORIES	GHG	Base year Estimate (kton CO ₂ eq.) 1990	Current year Estimate (kton CO ₂ eq.) 2021	Level Assess.	Cumulative Total	
1A.3.b Road Transportation	CO ₂	10,001	15,175	0.27	0.27	
1A.1 Energy industries - Gaseous fuels	CO ₂	0	5,430	0.10	0.37	
1A.2 Manufacturing industries and construction - Gaseous fuels	CO ₂	0	4,167	0.07	0.44	
3.A Enteric fermentation	CH ₄	3,943	4,064	0.07	0.51	
5.A Solid waste disposal	CH ₄	3,159	3,856	0.07	0.58	
2.F.1 Refrigeration and Air Conditioning	Fgases	NA	3,019	0.05	0.63	
1A.2 Manufacturing industries and construction - Liquid fuels	CO ₂	6,531	2,637	0.05	0.68	
1A.4 Combustion Other Sectors - Liquid fuels	CO ₂	3,463	2,591	0.05	0.73	
2.A.1 Mineral Industry - Cement production	CO ₂	3,176	2,106	0.04	0.76	
1A.1 Energy industries - Liquid fuels	CO ₂	8,354	1,562	0.03	0.79	
3.D.1 Direct N ₂ O Emissions From Managed Soils	N ₂ O	1,600	1,552	0.03	0.82	
1A.4 Combustion Other Sectors - Gaseous fuels	CO ₂	0	1,424	0.03	0.84	
3.B Manure Management	CH ₄	907	838	0.01	0.86	
1.B.2.a Fugitive emissions - Oil	CO ₂	0	819	0.01	0.87	
5.D Wastewater treatment and discharge	CH ₄	1,699	769	0.01	0.89	
1A.1 Energy industries - Solid fuels	CO ₂	8,011	691	0.01	0.90	
2.B.8 Chemical Industry - Petrochemical and Carbon Black production	CO ₂	645	638	0.01	0.91	
1A.1 Energy industries - Other fossil fuels	CO ₂	0	410	0.01	0.92	
3.D.2 Indirect N ₂ O Emissions From Managed Soils	N ₂ O	439	387	0.01	0.93	
2.A.2 Mineral Industry - Lime production	CO ₂	206	387	0.01	0.93	
1A.3.a Civil (domestic) aviation	CO ₂	178	340	0.01	0.94	
1A.2 Manufacturing industries and construction - Other fossil fuels	CO ₂	12	305	0.01	0.94	
2.A.4 Mineral Industry - Other Process Uses of Carbonates	CO ₂	220	258	0.00	0.95	
1A.4 Combustion Other Sectors - Biomass	CH ₄	476	237	0.00	0.95	

Table E-5: Trend assessment (Approach 1) without LULUCF: 1990- latest inventory year

Tier 1 Trend Assessment (1990-2021)						
IPCC SOURCE CATEGORIES	GHG	Base year Estimate (kton CO ₂ eq.) 1990	Current year Estimate (kton CO ₂ eq.) 2021	Trend Assess.	Contribution to Trend	Cumulative Total
1A.1 Energy industries - Solid fuels	CO ₂	8,011	691	0.09	0.16	0.16
1A.1 Energy industries - Liquid fuels	CO ₂	8,354	1,562	0.09	0.14	0.30
1A.3.b Road Transportation	CO ₂	10,001	15,175	0.08	0.13	0.43
1A.1 Energy industries - Gaseous fuels	CO ₂	0	5,430	0.07	0.12	0.55
1A.2 Manufacturing industries and construction - Gaseous fuels	CO ₂	0	4,167	0.06	0.09	0.64
1A.2 Manufacturing industries and construction - Liquid fuels	CO ₂	6,531	2,637	0.05	0.08	0.72
1A.2 Manufacturing industries and construction - Solid fuels	CO ₂	2,311	56	0.03	0.05	0.77
1A.4 Combustion Other Sectors - Gaseous fuels	CO ₂	0	1,424	0.02	0.03	0.80
2.A.1 Mineral Industry - Cement production	CO ₂	3,176	2,106	0.01	0.02	0.82
5.A Solid waste disposal	CH ₄	3,159	3,856	0.01	0.02	0.84
5.D Wastewater treatment and discharge	CH ₄	1,699	769	0.01	0.02	0.86
1B.2.a Fugitive emissions - Oil	CO ₂	0	819	0.01	0.02	0.88
2.B.1 Chemical Industry - Ammonia production	CO ₂	763	0	0.01	0.02	0.90
1A.4 Combustion Other Sectors - Liquid fuels	CO ₂	3,463	2,591	0.01	0.02	0.91
1A.1 Energy industries - Other fossil fuels	CO ₂	0	410	0.01	0.01	0.92
2.B.2 Chemical Industry - Nitric acid production	N ₂ O	460	33	0.01	0.01	0.93
2.C.1 Metal Industry - Iron and Steel production	CO ₂	440	65	0.00	0.01	0.94
3.A Enteric fermentation	CH ₄	3,943	4,064	0.00	0.01	0.95
1A.2 Manufacturing industries and construction - Other fossil fuels	CO ₂	12	305	0.00	0.01	0.95



Table E-6: Level assessment (Approach 2) without LULUCF: 1990

Tier 2 Level Assessment (1990)

IPCC SOURCE CATEGORIES	GHG	Base year	Current year	Level Assess.	Combined Uncert.	Level + Uncert.	Share Level + Uncert.	Cumulative Total
		Estimate (kton CO ₂ eq.) 1990	Estimate (kton CO ₂ eq.) 1990					
5.A Solid waste disposal	CH ₄	3,159	3,159	0.05	144.05	7.65	0.41	0.41
3.D.1 Direct N ₂ O Emissions From Managed Soils	N ₂ O	1600	1,600	0.03	76.16	2.05	0.11	0.52
5.D Wastewater treatment and discharge	CH ₄	1,699	1,699	0.03	53.78	1.54	0.08	0.60
5.D Wastewater treatment and discharge	N ₂ O	178	178	0.00	500.64	1.50	0.08	0.68
1.A.1 Energy industries - Solid fuels	CO ₂	8,011	8,011	0.13	6.61	0.89	0.05	0.73
2.A.1 Mineral Industry - Cement production	CO ₂	3,176	3,176	0.05	14.37	0.77	0.04	0.77
1.A.3.b Road Transportation	CO ₂	10,001	10,001	0.17	3.88	0.65	0.03	0.81
2.D Non-energy products from fuels and solvent use	CO ₂	242	242	0.00	12.184	0.50	0.03	0.83
1.A.1 Energy industries - Liquid fuels	CO ₂	8,354	8,354	0.14	2.75	0.39	0.02	0.85
1.A.2 Manufacturing industries and construction - Liquid fuels	CO ₂	6,531	6,531	0.11	2.78	0.30	0.02	0.87
1.B.1 Fugitive emissions - Solid Fuels	CH ₄	157	157	0.00	83.53	0.22	0.01	0.88
1.A.3.a Civil (domestic) aviation	CO ₂	178	178	0.00	73.49	0.22	0.01	0.89
1.A.2 Manufacturing industries and construction - Solid fuels	CO ₂	2,311	2,311	0.04	5.45	0.21	0.01	0.90
1.A.3.d Domestic navigation - Residual fuel oil	CO ₂	263	263	0.00	38.46	0.17	0.01	0.91

Table E-7: Level assessment (Approach 2) without LULUCF: latest inventory year

Tier 2 Level Assessment (2021)

IPCC SOURCE CATEGORIES	GHG	Base year	Current year	Level Assess.	Combined Uncert.	Level + Uncert.	Share Level + Uncert.	Cumulative Total
		Estimate (kton CO ₂ eq.) 1990	Estimate (kton CO ₂ eq.) 2021					
3.D.1 Direct N ₂ O Emissions From Managed Soils	N ₂ O	1,600	1,552	0.03	83.04	2.29	0.15	0.15
2.F.1 Refrigeration and Air Conditioning	Fgases	NA	3,019	0.05	36.66	1.96	0.13	0.28
5.A Solid waste disposal	CH ₄	3,159	3,856	0.07	24.75	1.69	0.11	0.39
5.D Wastewater treatment and discharge	N ₂ O	178	168	0.00	500.64	1.50	0.10	0.49
1.B.2.a Fugitive emissions - Oil	CO ₂	0	819	0.01	99.93	1.45	0.10	0.58
1.A.3.b Road Transportation	CO ₂	10,001	15,175	0.27	3.71	1.00	0.07	0.65
5.D Wastewater treatment and discharge	CH ₄	1,699	769	0.01	47.55	0.65	0.04	0.69
2.A.1 Mineral Industry - Cement production	CO ₂	3,176	2,106	0.04	14.19	0.53	0.03	0.73
2.D Non-energy products from fuels and solvent use	CO ₂	242	205	0.00	13.176	0.48	0.03	0.76
1.A.2 Manufacturing industries and construction - Liquid fuels	CO ₂	6,531	2,637	0.05	8.04	0.38	0.02	0.78
2.A.2 Mineral Industry - Lime production	CO ₂	206	387	0.01	35.60	0.24	0.02	0.80
1.A.1 Energy industries - Other fossil fuels	CO ₂	0	410	0.01	30.19	0.22	0.01	0.81
1.A.3.a Civil (domestic) aviation	CO ₂	178	340	0.01	35.89	0.22	0.01	0.83
3.C Rice cultivation	CH ₄	150	176	0.00	64.34	0.20	0.01	0.84
5.B Biological treatment of solid waste	CH ₄	6	88	0.00	109.62	0.17	0.01	0.85
5.C Incineration and open burning of waste	CO ₂	7	37	0.00	250.62	0.16	0.01	0.86
1.B.2.b Fugitive emissions - Natural Gas	CH ₄	0	59	0.00	146.28	0.15	0.01	0.87
2.B.8 Chemical Industry - Petrochemical and Carbon Black production	CO ₂	645	638	0.01	13.35	0.15	0.01	0.88
1.A.1 Energy industries - Gaseous fuels	CO ₂	0	5,430	0.10	1.56	0.15	0.01	0.89
1.A.3.d Domestic navigation - Residual fuel oil	CO ₂	263	207	0.00	38.46	0.14	0.01	0.90
1.A.4 Combustion Other Sectors - Liquid fuels	N ₂ O	52	61	0.00	115.87	0.13	0.01	0.91

Table E-8: Trend assessment (Approach 2) without LULUCF: 1990- latest inventory year

Tier 2 Trend Assessment (1990-2021)

IPCC SOURCE CATEGORIES	GHG	Base year	Current year	Trend Assess.	Combined Uncert.	Level + Uncert.	Share Level + Uncert.	Cumulative Total
		Estimate (kton CO ₂ eq.) 1990	Estimate (kton CO ₂ eq.) 2021					
1.B.2.a Fugitive emissions - Oil	CO ₂	0	819	0.01	99.93	1.11	0.21	0.21
5.D Wastewater treatment and discharge	CH ₄	1,699	769	0.01	47.55	0.54	0.10	0.31
1.A.2 Manufacturing industries and construction - Liquid fuels	CO ₂	6,531	2,637	0.05	8.04	0.39	0.07	0.38
1.A.1 Energy industries - Solid fuels	CO ₂	8,011	691	0.09	3.74	0.35	0.07	0.45
1.B.1 Fugitive emissions - Solid Fuels	CH ₄	157	17	0.00	166.97	0.30	0.06	0.50
5.A Solid waste disposal	CH ₄	3,159	3,856	0.01	24.75	0.29	0.05	0.55
1.A.3.b Road Transportation	CO ₂	10,001	15,175	0.08	3.71	0.29	0.05	0.61
2.A.1 Mineral Industry - Cement production	CO ₂	3,176	2,106	0.01	14.19	0.17	0.03	0.64
1.A.1 Energy industries - Other fossil fuels	CO ₂	0	410	0.01	30.19	0.17	0.03	0.67
1.A.1 Energy industries - Liquid fuels	CO ₂	8,354	1,562	0.09	1.76	0.15	0.03	0.70
5.B Biological treatment of solid waste	CH ₄	6	88	0.00	109.62	0.12	0.02	0.72
1.B.2.b Fugitive emissions - Natural Gas	CH ₄	0	59	0.00	146.28	0.12	0.02	0.74
1.A.1 Energy industries - Gaseous fuels	CO ₂	0	5,430	0.07	1.56	0.11	0.02	0.77
5.C Incineration and open burning of waste	CO ₂	7	37	0.00	250.62	0.10	0.02	0.78
2.A.2 Mineral Industry - Lime production	CO ₂	206	387	0.00	35.60	0.09	0.02	0.80
1.A.2 Manufacturing industries and construction - Solid fuels	CO ₂	2,311	56	0.03	3.02	0.09	0.02	0.82
1.A.3.a Civil (domestic) aviation	CO ₂	178	340	0.00	35.89	0.08	0.02	0.83
1.A.2 Manufacturing industries and construction - Other fossil fuels	CO ₂	12	305	0.00	20.97	0.08	0.02	0.85
1.A.2 Manufacturing industries and construction - Gaseous fuels	CO ₂	0	4,167	0.06	1.43	0.08	0.02	0.86
2.C.1 Metal Industry - Iron and Steel production	CO ₂	440	65	0.00	14.14	0.07	0.01	0.88
1.A.1 Energy industries - Gaseous fuels	N ₂ O	0	65	0.00	72.02	0.06	0.01	0.89
5.B Biological treatment of solid waste	N ₂ O	3	43	0.00	113.39	0.06	0.01	0.90
2.B.2 Chemical Industry - Nitric acid production	N ₂ O	460	33	0.01	10.20	0.06	0.01	0.91



Table E-9: Level assessment (Approach 1) with LULUCF: 1990

Tier 1 Level Assessment (1990)					
IPCC SOURCE CATEGORIES	GHG	Base year Estimate (kton CO2 eq.) 1990	Current year Estimate (kton CO2 eq.) 1990	Level Assess.	Cumulative Total
1A.3.b Road Transportation	CO2	10,001	10,001	0.14	0.14
1A.1Energy industries - Liquid fuels	CO2	8,354	8,354	0.11	0.25
1A.1Energy industries - Solid fuels	CO2	8,011	8,011	0.11	0.36
1A.2 Manufacturing industries and construction - Liquid fuels	CO2	6,531	6,531	0.09	0.44
4.A.1. Forest land remaining Forest land	CO2	4,986	4,986	0.07	0.51
3.A Enteric fermentation	CH4	3,943	3,943	0.05	0.56
1A.4 Combustion Other Sectors - Liquid fuels	CO2	3,463	3,463	0.05	0.61
2.A.1 Mineral Industry - Cement production	CO2	3,176	3,176	0.04	0.65
5.A Solid waste disposal	CH4	3,159	3,159	0.04	0.70
4.C.1. Grassland remaining Grassland	CO2	2,334	2,334	0.03	0.73
1A.2 Manufacturing industries and construction - Solid fuels	CO2	2,311	2,311	0.03	0.76
4.G. Other (Harvested Wood Products)	CO2	-2,127	-2,127	0.03	0.79
5.D Wastewater treatment and discharge	CH4	1,699	1,699	0.02	0.81
3.D.1Direct N2O Emissions From Managed Soils	N2O	1,600	1,600	0.02	0.83
4.A.2 Land converted to Forest land	CO2	-1,584	-1,584	0.02	0.85
4.B.1. Cropland remaining Cropland	CO2	952	952	0.01	0.87
3.B Manure Management	CH4	907	907	0.01	0.88
2.B.1 Chemical Industry - Ammonia production	CO2	763	763	0.01	0.89
2.B.8 Chemical Industry - Petrochemical and Carbon Black production	CO2	645	645	0.01	0.90
4.A.1. Forest land remaining Forest land	CH4	507	507	0.01	0.91
4.D.2 Land converted to Wetlands	CO2	501	501	0.01	0.91
1A.4 Combustion Other Sectors - Biomass	CH4	476	476	0.01	0.92
2.B.2 Chemical Industry - Nitric acid production	N2O	460	460	0.01	0.93
2.C.1 Metal Industry - Iron and Steel production	CO2	440	440	0.01	0.93
3.D.2 Indirect N2O Emissions From Managed Soils	N2O	439	439	0.01	0.94
4.B.2 Land converted to Cropland	CO2	372	372	0.01	0.94
4(IV) Indirect nitrous oxide (N2O)	N2O	293	293	0.00	0.95
4.E.2 Land converted to Settlements	CO2	271	271	0.00	0.95

Table E-10: Level assessment (Approach 1) with LULUCF: latest inventory year

Tier 1 Level Assessment (2021)					
IPCC SOURCE CATEGORIES	GHG	Base year Estimate (kton CO2 eq.) 1990	Current year Estimate (kton CO2 eq.) 2020	Level Assess.	Cumulative Total
1A.3.b Road Transportation	CO2	10,001	15,175	0.23	0.23
1A.1Energy industries - Gaseous fuels	CO2	0	5,430	0.08	0.31
1A.2 Manufacturing industries and construction - Gaseous fuels	CO2	0	4,167	0.06	0.38
3.A Enteric fermentation	CH4	3,943	4,064	0.06	0.44
5.A Solid waste disposal	CH4	3,159	3,856	0.06	0.50
2.F.1 Refrigeration and Air Conditioning	Fgase	NA	3,019	0.05	0.55
1A.2 Manufacturing industries and construction - Liquid fuels	CO2	6,531	2,637	0.04	0.59
1A.4 Combustion Other Sectors - Liquid fuels	CO2	3,463	2,591	0.04	0.62
4.C.1. Grassland remaining Grassland	CO2	2,334	-2,203	0.03	0.66
2.A.1 Mineral Industry - Cement production	CO2	3,176	2,106	0.03	0.69
4.B.1. Cropland remaining Cropland	CO2	952	-1,914	0.03	0.72
4.A.2 Land converted to Forest land	CO2	-1,584	-1,663	0.03	0.75
1A.1Energy industries - Liquid fuels	CO2	8,354	1,562	0.02	0.77
3.D.1Direct N2O Emissions From Managed Soils	N2O	1,600	1,552	0.02	0.79
1A.4 Combustion Other Sectors - Gaseous fuels	CO2	0	1,424	0.02	0.81
4.A.1. Forest land remaining Forest land	CO2	4,986	-877	0.01	0.83
3.B Manure Management	CH4	907	838	0.01	0.84
1B.2.a Fugitive emissions - Oil	CO2	0	819	0.01	0.85
5.D Wastewater treatment and discharge	CH4	1,699	769	0.01	0.86
1A.1Energy industries - Solid fuels	CO2	8,011	691	0.01	0.88
4.C.2 Land converted to Grassland	CO2	0	-677	0.01	0.89
2.B.8 Chemical Industry - Petrochemical and Carbon Black production	CO2	645	638	0.01	0.90
1A.1Energy industries - Other fossil fuels	CO2	0	410	0.01	0.90
3.D.2 Indirect N2O Emissions From Managed Soils	N2O	439	387	0.01	0.91
2.A.2 Mineral Industry - Lime production	CO2	206	387	0.01	0.91
4(IV) Indirect nitrous oxide (N2O)	N2O	293	386	0.01	0.92
4.D.2 Land converted to Wetlands	CO2	501	371	0.01	0.93
1A.3.a Civil (domestic) aviation	CO2	178	340	0.01	0.93
1A.2 Manufacturing industries and construction - Other fossil fuels	CO2	12	305	0.00	0.94
2.A.4 Mineral Industry - Other Process Uses of Carbonates	CO2	220	258	0.00	0.94
4.G. Other (Harvested Wood Products)	CO2	-2,127	-253	0.00	0.94
4.B.2 Land converted to Cropland	CO2	372	248	0.00	0.95
1A.4 Combustion Other Sectors - Biomass	CH4	476	237	0.00	0.95



Table E-11: Trend assessment (Approach 1) with LULUCF: 1990- latest inventory year

Tier 1 Trend Assessment (1990-2021)

IPCC SOURCE CATEGORIES	GHG	Base year Estimate (kton CO2 eq.) 1990	Current year Estimate (kton CO2 eq.) 2021	Trend Assess.	Contribution to Trend	Cumulative Total
1A.3.b Road Transportation	CO2	10,001	15,175	0.10	0.13	0.13
1A.1 Energy industries - Gaseous fuels	CO2	0	5,430	0.07	0.10	0.23
1A.1 Energy industries - Solid fuels	CO2	8,011	691	0.07	0.09	0.32
1A.1 Energy industries - Liquid fuels	CO2	8,354	1,562	0.06	0.08	0.41
4.A.1 Forest land remaining Forest land	CO2	4,986	-877	0.06	0.08	0.49
1A.2 Manufacturing industries and construction - Gaseous fuels	CO2	0	4,167	0.06	0.07	0.56
4.C.1 Grassland remaining Grassland	CO2	2,334	-2,203	0.05	0.07	0.63
4.B.1 Cropland remaining Cropland	CO2	952	-1,914	0.04	0.05	0.68
4.G Other (Harvested Wood Products)	CO2	-2,127	-253	0.03	0.04	0.72
1A.2 Manufacturing industries and construction - Liquid fuels	CO2	6,531	2,637	0.03	0.04	0.76
1A.2 Manufacturing industries and construction - Solid fuels	CO2	2,311	56	0.02	0.03	0.79
5A Solid waste disposal	CH4	3,159	3,856	0.02	0.03	0.82
1A.4 Combustion Other Sectors - Gaseous fuels	CO2	0	1,424	0.02	0.03	0.84
3A Enteric fermentation	CH4	3,943	4,064	0.01	0.02	0.86
1B.2.a Fugitive emissions - Oil	CO2	0	819	0.01	0.01	0.88
4.C.2 Land converted to Grassland	CO2	0	-677	0.01	0.01	0.89
2.B.1 Chemical Industry - Ammonia production	CO2	763	0	0.01	0.01	0.90
5.D Wastewater treatment and discharge	CH4	1,699	769	0.01	0.01	0.91
1A.1 Energy industries - Other fossil fuels	CO2	0	410	0.01	0.01	0.91
3.D.1 Direct N2O Emissions From Managed Soils	N2O	1,600	1,552	0.00	0.01	0.92
2.B.2 Chemical Industry - Nitric acid production	N2O	460	33	0.00	0.01	0.92
4.A.2 Land converted to Forest land	CO2	-1,584	-1,663	0.00	0.01	0.93
1A.2 Manufacturing industries and construction - Other fossil fuels	CO2	12	305	0.00	0.01	0.94
2.A.1 Mineral Industry - Cement production	CO2	3,176	2,106	0.00	0.01	0.94
2.C.1 Metal Industry - Iron and Steel production	CO2	440	65	0.00	0.00	0.95
2.A.2 Mineral Industry - Lime production	CO2	206	387	0.00	0.00	0.95
1A.3.a Civil (domestic) aviation	CO2	178	340	0.00	0.00	0.95

Table E-12: Level assessment (Approach 2) with LULUCF: 1990

Tier 2 Level Assessment (1990)

IPCC SOURCE CATEGORIES	GHG	Base year Estimate (kton CO2 eq.) 1990	Current year Estimate (kton CO2 eq.) 1990	Level Assess.	Combined Uncert. %	Level * Uncert. %	Share Level * Uncert. %	Cumulative Total
5A Solid waste disposal	CH4	3,159	3,159	0.04	144.05	6.15	0.28	0.28
4.A.1 Forest land remaining Forest land	CO2	4,986	4,986	0.07	29.63	2.00	0.09	0.37
4.B.1 Cropland remaining Cropland	CO2	952	952	0.01	148.69	1.91	0.09	0.46
3.D.1 Direct N2O Emissions From Managed Soils	N2O	1,600	1,600	0.02	76.16	1.65	0.08	0.54
5.D Wastewater treatment and discharge	CH4	1,699	1,699	0.02	53.78	1.23	0.06	0.59
5.D Wastewater treatment and discharge	N2O	178	178	0.00	500.64	1.20	0.06	0.65
4.E.2 Land converted to Settlements	CO2	271	271	0.00	249.08	0.91	0.04	0.69
4.C.1 Grassland remaining Grassland	CO2	2,334	2,334	0.03	23.12	0.73	0.03	0.72
1A.1 Energy industries - Solid fuels	CO2	8,011	8,011	0.11	6.61	0.72	0.03	0.76
2.A.1 Mineral Industry - Cement production	CO2	3,176	3,176	0.04	14.37	0.62	0.03	0.78
1A.3.b Road Transportation	CO2	10,001	10,001	0.14	3.88	0.52	0.02	0.81
2.D Non-energy products from fuels and solvent use	CO2	242	242	0.00	121.84	0.40	0.02	0.83
4.A.2 Land converted to Forest land	CO2	-1,584	-1,584	0.02	16.80	0.36	0.02	0.84
1A.1 Energy industries - Liquid fuels	CO2	8,354	8,354	0.11	2.75	0.31	0.01	0.86
1A.2 Manufacturing industries and construction - Liquid fuels	CO2	6,531	6,531	0.09	2.78	0.24	0.01	0.87
4.C.1 Grassland remaining Grassland	CH4	213	213	0.00	62.05	0.48	0.01	0.88
1B.1 Fugitive emissions - Solid Fuels	CH4	157	157	0.00	83.53	0.48	0.01	0.88
1A.3.a Civil (domestic) aviation	CO2	178	178	0.00	73.49	0.48	0.01	0.89
4.B.2 Land converted to Cropland	CO2	372	372	0.01	35.07	0.48	0.01	0.90
1A.2 Manufacturing industries and construction - Solid fuels	CO2	2,311	2,311	0.03	5.45	0.17	0.01	0.91

Table E-13: Level assessment (Approach 2) with LULUCF: latest inventory year

Tier 2 Level Assessment (2021)

IPCC SOURCE CATEGORIES	GHG	Base year Estimate (kton CO2 eq.) 1990	Current year Estimate (kton CO2 eq.) 2021	Level Assess.	Combined Uncert. %	Level * Uncert. %	Share Level * Uncert. %	Cumulative Total
4.B.1 Cropland remaining Cropland	CO2	952	-1,914	0.03	148.69	4.34	0.21	0.21
3.D.1 Direct N2O Emissions From Managed Soils	N2O	1,600	1,552	0.02	83.04	1.97	0.10	0.31
2.F.1 Refrigeration and Air Conditioning	Fgases	NA	3,019	0.05	36.66	1.69	0.08	0.39
5A Solid waste disposal	CH4	3,159	3,856	0.06	24.75	1.46	0.07	0.46
5.D Wastewater treatment and discharge	N2O	178	178	0.00	500.64	1.29	0.06	0.53
1B.2.a Fugitive emissions - Oil	CO2	0	819	0.01	99.93	1.25	0.06	0.59
1A.3.b Road Transportation	CO2	10,001	15,175	0.23	3.71	0.86	0.04	0.63
4.C.1 Grassland remaining Grassland	CO2	2,334	-2,203	0.03	23.12	0.78	0.04	0.67
5.D Wastewater treatment and discharge	CH4	1,699	769	0.01	47.55	0.56	0.03	0.69
4.C.2 Land converted to Grassland	CO2	0	-677	0.01	53.33	0.55	0.03	0.72
2.A.1 Mineral Industry - Cement production	CO2	3,176	2,106	0.03	14.19	0.46	0.02	0.74
4.A.2 Land converted to Forest land	CO2	-1,584	-1,663	0.03	16.80	0.43	0.02	0.76
2.D Non-energy products from fuels and solvent use	CO2	242	205	0.00	131.76	0.41	0.02	0.78
4.A.1 Forest land remaining Forest land	CO2	4,986	-877	0.01	29.63	0.40	0.02	0.80
4.E.2 Land converted to Settlements	CO2	271	96	0.00	249.08	0.36	0.02	0.82
1A.2 Manufacturing industries and construction - Liquid fuels	CO2	6,531	2,637	0.04	8.04	0.32	0.02	0.84
2.A.2 Mineral Industry - Lime production	CO2	206	387	0.01	35.60	0.21	0.01	0.85
1A.1 Energy industries - Other fossil fuels	CO2	0	410	0.01	30.19	0.19	0.01	0.86
1A.3.a Civil (domestic) aviation	CO2	178	340	0.01	35.89	0.19	0.01	0.87
3.C Rice cultivation	CH4	150	176	0.00	64.34	0.17	0.01	0.87
5.B Biological treatment of solid waste	CH4	6	88	0.00	109.62	0.15	0.01	0.88
5.C Incineration and open burning of waste	CO2	7	37	0.00	250.62	0.14	0.01	0.89
4.B.2 Land converted to Cropland	CO2	372	248	0.00	35.07	0.13	0.01	0.89
1B.2.b Fugitive emissions - Natural Gas	CH4	0	59	0.00	146.28	0.13	0.01	0.90



Table E-14: Trend assessment (Approach 2) with LULUCF: 1990- latest inventory year

Tier 2 Trend Assessment (1990-2021)

IPCC SOURCE CATEGORIES	GHG	Base year Estimate (kton CO2 eq.) 1990	Current year Estimate (kton CO2 eq.) 2021	Trend Assess.	Combined Uncert. %	Level * Uncert. %	Share Level * Uncert. %	Cumulative Total
4.B.1. Cropland remaining Cropland	CO2	952	-19.44	0.03	148.69	4.34	0.21	0.21
3.D.1 Direct N2O Emissions From Managed Soils	N2O	1,600	1,552	0.02	93.04	1.97	0.10	0.31
2.F.1 Refrigeration and Air Conditioning	Fgases	NA	3,019	0.05	36.66	1.69	0.08	0.39
5.A Solid waste disposal	CH4	3,459	3,856	0.06	24.75	1.46	0.07	0.46
5.D Wastewater treatment and discharge	N2O	178	168	0.00	500.64	1.29	0.06	0.53
1B.2.a Fugitive emissions - Oil	CO2	0	8.19	0.01	99.93	1.25	0.06	0.59
1A.3.b Road Transportation	CO2	10,001	15,175	0.23	3.71	0.86	0.04	0.63
4.C.1 Grassland remaining Grassland	CO2	2,334	-2,203	0.03	23.12	0.78	0.04	0.67
5.D Wastewater treatment and discharge	CH4	1,699	769	0.01	47.55	0.56	0.03	0.69
4.C.2 Land converted to Grassland	CO2	0	-6.77	0.01	53.33	0.55	0.03	0.72
2.A.1 Mineral Industry - Cement production	CO2	3,176	2,106	0.03	14.19	0.46	0.02	0.74
4.A.2 Land converted to Forest land	CO2	-1,584	-1,663	0.03	16.80	0.43	0.02	0.76
2.D Non-energy products from fuels and solvent use	CO2	242	205	0.00	131.76	0.41	0.02	0.78
4.A.1 Forest land remaining Forest land	CO2	4,986	-8.77	0.01	29.63	0.40	0.02	0.80
4.E.2 Land converted to Settlements	CO2	271	96	0.00	249.08	0.36	0.02	0.82
1A.2 Manufacturing industries and construction - Liquid fuels	CO2	6,531	2,637	0.04	8.04	0.32	0.02	0.84
2.A.2 Mineral Industry - Lime production	CO2	206	397	0.01	35.60	0.21	0.01	0.85
1A.1 Energy industries - Other fossil fuels	CO2	0	4.10	0.01	30.19	0.19	0.01	0.86
1A.3.a Civil (domestic) aviation	CO2	178	340	0.01	35.89	0.19	0.01	0.87
3.C Rice cultivation	CH4	150	176	0.00	64.34	0.17	0.01	0.87
5.B Biological treatment of solid waste	CH4	6	88	0.00	109.62	0.15	0.01	0.88
5.C Incineration and open burning of waste	CO2	7	37	0.00	250.62	0.14	0.01	0.89
4.B.2 Land converted to Cropland	CO2	372	248	0.00	35.07	0.13	0.01	0.89
1B.2.b Fugitive emissions - Natural Gas	CH4	0	59	0.00	146.28	0.13	0.01	0.90



Annex F: Uncertainty Assessment

Updated: March 2023

Uncertainty in the inventory of emissions and removals of GHG results from the natural variability of emission processes, incomplete knowledge of emission sources and definition, errors and gaps in data collection and statistical information, incorrect determination and choice of emission factors and parameter due to errors in original monitoring data, reference studies and expert judgement.

Uncertainty values were defined as the range of 95% confidence interval (IPCC, 1997; IPCC, 2000), meaning that there is a 95 % probability that the actual value of the quantity (activity data, emission factor or emission) is within the interval defined by the confidence limits.

The uncertainty analysis was performed solely for the direct GHG: CO₂, CH₄, N₂O, considering all emissions in CO₂e. The uncertainty of all source activities was considered to overall uncertainty including the uncertainty of LULUCF category.

An approach 1 methodology was used to estimate total uncertainty for the inventory, for one individual year and also the uncertainty in trend. Basically this method of classical analysis, which is explained in more detail in IPCC (2000), attributes uncertainty values to activity data and emission factors, for each of the pollutants, and uses error propagation rules to combine uncertainty estimates for each individual source into total uncertainty. In accordance with IPCC (2000) considerations, the uncertainty in Global Warming Potentials (GWP) is not included in uncertainty quantification. The uncertainty values, both for activity data and emission factors, are discussed in the detailed analysis of emission estimates for each individual source sector.

The uncertainty is estimated for individual years, from emission estimates in specific years and uncertainty values for both activity data and implied emission factors, but also for the trend of emissions for each individual category.



Table F-1: Approach 1 Uncertainty Estimates: 2021

IPCC category/Group	Gas	Base year emissions or removals	Year x emissions or removals	Activity data uncertainty (1)	Emission factor / estimation parameter uncertainty (1)	Combined uncertainty	Contribution to variance by category in year x	Type A sensitivity	Type B sensitivity	Uncertainty in trend in national emissions introduced by emission factor / estimation parameter uncertainty (2)	Uncertainty in trend in national emissions introduced by activity data uncertainty (3)	Uncertainty introduced into the trend in total national emissions	Comments Key Category (KC)
		Gg CO2 equivalent	Gg CO2 equivalent	%	%	%		%	%	%	%	%	
		input data	input data	input data Note A	input data Note A	$\sqrt{E^2 + F^2}$	$\frac{(G \cdot D)^2}{(\sum D)^2}$	Note B	$\frac{ D }{\sum C}$	I*F Note C	J*E*sqrt(2) Note D	K^2 + L^2	
1.A.1 Energy industries - Liquid fuels	CO2	8354.14	1562.39	1.4	1.1	1.7631	0.0030	0.0712	0.0235	0.0750	0.0469	0.00783	KC
1.A.1 Energy industries - Solid fuels	CO2	8011.47	690.64	2.2	3.0	3.7417	0.0026	0.0804	0.0104	0.2413	0.0328	0.05929	KC
1.A.1 Energy industries - Gaseous fuels	CO2	0.00	5429.72	0.9	1.2	1.5558	0.0282	0.0815	0.0815	0.1004	0.1095	0.02208	KC
1.A.1 Energy industries - Other fossil fuels	CO2	0.00	409.66	5.0	29.8	30.1895	0.0604	0.0061	0.0061	0.1831	0.0435	0.03542	KC
1.A.2 Manufacturing industries and construction - Liquid fuels	CO2	6530.99	2637.00	3.7	7.2	8.0412	0.1774	0.0345	0.0396	0.2469	0.2046	0.10284	KC
1.A.2 Manufacturing industries and construction - Solid fuels	CO2	2311.33	56.44	1.1	2.8	3.0247	0.0000	0.0254	0.0008	0.0715	0.0013	0.00512	KC
1.A.2 Manufacturing industries and construction - Gaseous fuels	CO2	0.01	4167.22	0.8	1.2	1.4277	0.0140	0.0626	0.0626	0.0744	0.0699	0.01042	KC
1.A.2 Manufacturing industries and construction - Other fossil fuels	CO2	12.21	304.87	6.1	20.1	20.9702	0.0161	0.0044	0.0046	0.0890	0.0396	0.00949	KC
1.A.3.a Civil (domestic) aviation	CO2	177.82	340.11	35.5	5.0	35.8907	0.0588	0.0031	0.0051	0.0154	0.2566	0.06610	KC
1.A.3.b Road Transportation	CO2	10000.59	15174.67	2.5	2.8	3.7097	1.2506	0.1142	0.2278	0.3171	0.7923	0.72835	KC
1.A.3.c Railways - Liquid fuels	CO2	177.19	25.53	2.9	1.7	3.3431	0.0000	0.0016	0.0004	0.0027	0.0016	0.00001	
1.A.3.d Domestic navigation - Residual fuel oil	CO2	262.52	207.09	38.0	5.8	38.4636	0.0250	0.0001	0.0031	0.0008	0.1672	0.02795	
1.A.4 Combustion Other Sectors - Liquid fuels	CO2	3463.33	2591.30	1.0	0.5	1.1468	0.0035	0.0004	0.0389	0.0002	0.0556	0.00309	KC
1.A.4 Combustion Other Sectors - Gaseous fuels	CO2	0.00	1424.39	0.1	0.1	0.0824	0.0000	0.0214	0.0214	0.0014	0.0015	0.00000	KC
1.A.5 Combustion Non-SpecifiedOther - Liquid fuels	CO2	96.11	72.90	5.0	5.0	7.0711	0.0001	0.0000	0.0011	0.0000	0.0077	0.00006	
1.B.1.Fugitive emissions – Solid Fuels	CO2	2.88	0.00	3.5	100.4	100.4988	0.0000	0.0000	0.0000	0.0033	0.0000	0.00001	
1.B.2.a Fugitive emissions - Oil	CO2	0.43	819.23	29.7	95.4	99.9252	2.6446	0.0123	0.0123	1.1729	0.5167	1.64273	KC
1.B.2.b Fugitive emissions - Natural Gas	CO2	0.00	0.04	0.2	146.2	146.2336	0.0000	0.0000	0.0000	0.0001	0.0000	0.00000	
1.B.2.c Venting and Flaring	CO2	52.49	93.96	29.7	1.0	29.7489	0.0031	0.0008	0.0014	0.0008	0.0593	0.00352	
1.B.2.d Geothermal	CO2	0.80	31.59	3.5	29.6	29.8060	0.0003	0.0005	0.0005	0.0138	0.0024	0.00020	



National Inventory Report - Portugal



IPCC category/Group	Gas	Base year emissions or removals	Year x emissions or removals	Activity data uncertainty (1)	Emission factor / estimation parameter uncertainty (1)	Combined uncertainty	Contribution to variance by category in year x	Type A sensitivity	Type B sensitivity	Uncertainty in trend in national emissions introduced by emission factor / estimation parameter uncertainty (2)	Uncertainty in trend in national emissions introduced by activity data uncertainty (3)	Uncertainty introduced into the trend in total national emissions	Comments Key Category (KC)
		Gg CO2 equivalent	Gg CO2 equivalent	%	%	%		%	%	%	%	%	
		input data	input data	input data Note A	input data Note A	$\sqrt{E^2 + F^2}$	$\frac{(G \cdot D)^2}{(\sum D)^2}$	Note B	$\frac{D}{\sum C}$	I*F Note C	J*E*sqrt(2) Note D	K^2 + L^2	
2.A.1 Mineral Industry - Cement production	CO2	3176.37	2105.92	14.1	1.6	14.1871	0.3523	0.0044	0.0316	0.0072	0.6301	0.39710	KC
2.A.2 Mineral Industry - Lime production	CO2	206.16	386.63	35.0	6.3	35.5985	0.0748	0.0035	0.0058	0.0219	0.2876	0.08317	KC
2.A.3 Mineral Industry - Glass production	CO2	68.88	160.03	5.4	2.2	5.8310	0.0003	0.0016	0.0024	0.0036	0.0183	0.00035	
2.A.4 Mineral Industry - Other Process Uses of Carbonates	CO2	220.16	258.31	2.6	1.0	2.7698	0.0002	0.0014	0.0039	0.0014	0.0141	0.00020	KC
2.B.1 Chemical Industry - Ammonia production	CO2	763.47	0.00	2.0	7.0	7.2801	0.0000	0.0087	0.0000	0.0606	0.0000	0.00368	
2.B.6 Titanium dioxide production	CO2	0.00	0.03	10.0	15.0	18.0278	0.0000	0.0000	0.0000	0.0000	0.0000	0.00000	
2.B.8 Chemical Industry - Petrochemical and Carbon Black production	CO2	645.07	637.53	3.5	12.9	13.3550	0.0286	0.0023	0.0096	0.0290	0.0471	0.00306	KC
2.C.1 Metal Industry - Iron and Steel production	CO2	439.62	64.99	10.0	10.0	14.1421	0.0003	0.0040	0.0010	0.0401	0.0138	0.00180	KC
2.C.5 Lead production	CO2	6.63	12.98	10.0	10.0	14.1421	0.0000	0.0001	0.0002	0.0012	0.0028	0.00001	
2.D Non-energy products from fuels and solvent use	CO2	242.41	205.23	11.3	131.3	131.7643	0.2886	0.0003	0.0031	0.0434	0.0493	0.00432	KC
3.G Liming	CO2	6.49	9.15	45.4	0.0	45.4250	0.0001	0.0001	0.0001	0.0000	0.0088	0.00008	
3.H Urea application & 3.I Other carbon-containing fertilizers	CO2	41.95	21.88	24.9	9.8	26.7772	0.0001	0.0001	0.0003	0.0014	0.0116	0.00014	
4.A.1. Forest land remaining Forest land	CO2	4986.44	-877.27	6.9	28.8	29.6260	0.2666	0.0697	0.0132	2.0082	0.1281	4.04937	KC
4.A.2 Land converted to Forest land	CO2	-1583.86	-1663.04	4.3	16.2	16.7955	0.3079	0.0070	0.0250	0.1136	0.1522	0.03609	KC
4.B.1. Cropland remaining Cropland	CO2	951.69	-1914.34	2.7	148.7	148.6925	31.9756	0.0395	0.0287	5.8769	0.1110	34.55018	KC
4.B.2 Land converted to Cropland	CO2	372.19	247.51	7.7	34.2	35.0689	0.0297	0.0005	0.0037	0.0173	0.0403	0.00192	KC
4.C.1. Grassland remaining Grassland	CO2	2333.96	-2203.35	22.5	5.3	23.1201	1.0241	0.0595	0.0331	0.3166	1.0525	1.20809	KC
4.C.2 Land converted to Grassland	CO2	0.00	-677.49	5.3	53.1	53.3304	0.5152	0.0102	0.0102	0.5397	0.0765	0.29714	KC
4.D.2 Land converted to Wetlands	CO2	0.00	-0.58	22.5	0.0	22.5000	0.0000	0.0000	0.0000	0.0000	0.0003	0.00000	
4.E.2 Land converted to Settlements	CO2	500.93	371.27	16.0	11.1	19.4907	0.0207	0.0001	0.0056	0.0012	0.1264	0.01597	KC



National Inventory Report - Portugal



IPCC category/Group	Gas	Base year emissions or removals	Year x emissions or removals	Activity data uncertainty (1)	Emission factor / estimation parameter uncertainty (1)	Combined uncertainty	Contribution to variance by category in year x	Type A sensitivity	Type B sensitivity	Uncertainty in trend in national emissions introduced by emission factor / estimation parameter uncertainty (2)	Uncertainty in trend in national emissions introduced by activity data uncertainty (3)	Uncertainty introduced into the trend in total national emissions	Comments
		Gg CO2 equivalent	Gg CO2 equivalent	%	%	%		%	%	%	%	%	Key Category (KC)
		input data	input data	input data Note A	input data Note A	$\sqrt{E^2 + F^2}$	$\frac{(G \cdot D)^2}{(\sum D)^2}$	Note B	$\frac{ D }{\sum C}$	I*F Note C	J*E*sqrt(2) Note D	K^2 + L^2	
4.G. Other (Harvested Wood Products)	CO2	-2127.08	-253.09	0.0	0.0	0.0000	0.0000	0.0203	0.0038	0.0000	0.0000	0.00000	KC
5.C Incineration and open burning of waste	CO2	7.07	36.91	12.6	250.3	250.6242	0.0338	0.0005	0.0006	0.1186	0.0099	0.01416	KC
1.A.1 Energy industries - Liquid fuels	CH4	3.74	1.18	1.4	107.9	107.8712	0.0000	0.0000	0.0000	0.0027	0.0000	0.00001	
1.A.1 Energy industries - Solid fuels	CH4	2.94	0.21	2.2	135.0	135.0370	0.0000	0.0000	0.0000	0.0041	0.0000	0.00002	
1.A.1 Energy industries - Gaseous fuels	CH4	0.00	2.73	0.9	62.5	62.4664	0.0000	0.0000	0.0000	0.0026	0.0001	0.00001	
1.A.1 Energy industries - Other fossil fuels	CH4	0.00	3.29	5.0	100.5	100.6231	0.0000	0.0000	0.0000	0.0050	0.0003	0.00002	
1.A.1 Energy industries - Biomass	CH4	0.00	7.06	11.4	73.4	74.2686	0.0001	0.0001	0.0001	0.0078	0.0017	0.00006	
1.A.2 Manufacturing industries and construction - Liquid fuels	CH4	16.84	9.43	3.7	49.4	49.5402	0.0001	0.0000	0.0001	0.0024	0.0007	0.00001	
1.A.2 Manufacturing industries and construction - Solid fuels	CH4	1.81	0.09	1.1	95.8	95.7598	0.0000	0.0000	0.0000	0.0018	0.0000	0.00000	
1.A.2 Manufacturing industries and construction - Gaseous fuels	CH4	0.00	26.47	0.8	85.7	85.7096	0.0020	0.0004	0.0004	0.0341	0.0005	0.00116	
1.A.2 Manufacturing industries and construction - Other fossil fuels	CH4	0.01	0.37	6.1	99.3	99.5311	0.0000	0.0000	0.0000	0.0005	0.0000	0.00000	
1.A.2 Manufacturing industries and construction - Biomass	CH4	17.29	22.42	9.0	56.0	56.7261	0.0006	0.0001	0.0003	0.0079	0.0043	0.00008	
1.A.3.a Civil (domestic) aviation	CH4	1.10	0.38	35.5	94.9	101.3581	0.0000	0.0000	0.0000	0.0006	0.0003	0.00000	
1.A.3.b Road Transportation	CH4	108.80	20.51	2.5	22.7	22.8121	0.0001	0.0009	0.0003	0.0210	0.0011	0.00044	
1.A.3.c Railways - Liquid fuels	CH4	0.28	0.04	2.9	141.9	141.9322	0.0000	0.0000	0.0000	0.0004	0.0000	0.00000	
1.A.3.d Domestic navigation - Residual fuel oil	CH4	0.67	0.53	38.0	76.9	85.7566	0.0000	0.0000	0.0000	0.0000	0.0004	0.00000	
1.A.4 Combustion Other Sectors - Liquid fuels	CH4	6.67	3.99	1.0	33.0	32.9670	0.0000	0.0000	0.0001	0.0005	0.0001	0.00000	
1.A.4 Combustion Other Sectors - Gaseous fuels	CH4	0.00	0.68	0.1	6.6	6.6277	0.0000	0.0000	0.0000	0.0001	0.0000	0.00000	
1.A.4 Combustion Other Sectors - Biomass	CH4	475.91	236.60	0.0	0.4	0.3682	0.0000	0.0018	0.0036	0.0007	0.0001	0.00000	KC
1.A.5 Combustion Non-Specified - Other - Liquid fuels	CH4	0.02	0.01	5.0	40.0	40.3113	0.0000	0.0000	0.0000	0.0000	0.0000	0.00000	



National Inventory Report - Portugal



IPCC category/Group	Gas	Base year emissions or removals	Year x emissions or removals	Activity data uncertainty (1)	Emission factor / estimation parameter uncertainty (1)	Combined uncertainty	Contribution to variance by category in year x	Type A sensitivity	Type B sensitivity	Uncertainty in trend in national emissions introduced by emission factor / estimation parameter uncertainty (2)	Uncertainty in trend in national emissions introduced by activity data uncertainty (3)	Uncertainty introduced into the trend in total national emissions	Comments
		Gg CO2 equivalent	Gg CO2 equivalent	%	%	%		%	%	%	%	%	Key Category (KC)
		input data	input data	input data Note A	input data Note A	$\sqrt{E^2 + F^2}$	$\frac{(G \cdot D)^2}{(\sum D)^2}$	Note B	$\frac{D}{\sum C}$	I*F Note C	J*E*sqrt(2) Note D	K^2 + L^2	
1.B.1.Fugitive emissions – Solid Fuels	CH4	156.91	17.00	10.0	166.7	166.9664	0.0032	0.0015	0.0003	0.2541	0.0036	0.06460	KC
1.B.2.a Fugitive emissions - Oil	CH4	1.87	1.71	29.7	50.0	58.1719	0.0000	0.0000	0.0000	0.0002	0.0011	0.00000	
1.B.2.b Fugitive emissions - Natural Gas	CH4	0.00	58.55	4.8	146.2	146.2841	0.0290	0.0009	0.0009	0.1285	0.0060	0.01655	KC
1.B.2.c Venting and Flaring	CH4	0.57	1.38	28.6	72.2	77.7126	0.0000	0.0000	0.0000	0.0010	0.0008	0.00000	
2.B.8 Chemical Industry - Petrochemical and Carbon Black production	CH4	28.59	30.21	8.6	11.2	14.1421	0.0001	0.0001	0.0005	0.0014	0.0055	0.00003	
2.C.1 Metal Industry - Iron and Steel production	CH4	0.67	0.00	0.0	0.0	0.0000	0.0000	0.0000	0.0000	0.0000	0.0000	0.00000	
3.A Enteric fermentation	CH4	3942.59	4063.91	0.3	11.8	11.7659	0.9023	0.0163	0.0610	0.1914	0.0256	0.03728	KC
3.B Manure Management	CH4	907.37	838.30	10.0	49.8	50.7658	0.7147	0.0023	0.0126	0.1140	0.1780	0.04467	KC
3.C Rice cultivation	CH4	149.99	175.81	10.2	63.5	64.3410	0.0505	0.0009	0.0026	0.0596	0.0381	0.00500	KC
3.F Field burning of agricultural residues	CH4	10.25	7.12	43.6	39.1	58.5497	0.0001	0.0000	0.0001	0.0004	0.0066	0.00004	
4.A.1. Forest land remaining Forest land	CH4	507.18	196.55	8.8	22.7	24.3730	0.0091	0.0028	0.0030	0.0637	0.0366	0.00540	KC
4.A.2 Land converted to Forest land	CH4	0.00	0.70	8.8	13.9	16.4724	0.0000	0.0000	0.0000	0.0001	0.0001	0.00000	
4.B.1. Cropland remaining Cropland	CH4	97.03	14.33	12.0	24.2	27.0394	0.0001	0.0009	0.0002	0.0215	0.0036	0.00047	
4.B.2 Land converted to Cropland	CH4	0.00	0.29	8.8	24.3	25.8342	0.0000	0.0000	0.0000	0.0001	0.0001	0.00000	
4.C.1. Grassland remaining Grassland	CH4	213.47	36.85	22.5	57.8	62.0504	0.0021	0.0019	0.0006	0.1081	0.0176	0.01198	KC
4.C.2 Land converted to Grassland	CH4	0.00	0.71	11.3	28.9	31.0284	0.0000	0.0000	0.0000	0.0003	0.0002	0.00000	
4.F.2 Land converted to Other Land	CH4	3159.12	3855.60	13.3	20.9	24.7473	3.5928	0.0220	0.0579	0.4595	1.0905	1.40023	KC
5.A Solid waste disposal	CH4	5.63	88.17	14.1	108.7	109.6161	0.0369	0.0013	0.0013	0.1369	0.0265	0.01946	KC
5.B Biological treatment of solid waste	CH4	38.03	29.95	12.9	51.7	53.2824	0.0010	0.0000	0.0004	0.0009	0.0082	0.00007	
5.C Incineration and open burning of waste	CH4	1698.81	769.08	22.9	41.6	47.5474	0.5277	0.0077	0.0115	0.3217	0.3747	0.24388	KC
5.D Wastewater treatment and discharge	CH4	156.91	17.00	10.0	166.7	166.9664	0.0032	0.0015	0.0003	0.2541	0.0036	0.06460	KC



National Inventory Report - Portugal



IPCC category/Group	Gas	Base year emissions or removals	Year x emissions or removals	Activity data uncertainty (1)	Emission factor / estimation parameter uncertainty (1)	Combined uncertainty	Contribution to variance by category in year x	Type A sensitivity	Type B sensitivity	Uncertainty in trend in national emissions introduced by emission factor / estimation parameter uncertainty (2)	Uncertainty in trend in national emissions introduced by activity data uncertainty (3)	Uncertainty introduced into the trend in total national emissions	Comments
		Gg CO2 equivalent	Gg CO2 equivalent	%	%	%		%	%	%	%	%	
		input data	input data	input data Note A	input data Note A	$\sqrt{E^2 + F^2}$	$\frac{(G \cdot D)^2}{(\sum D)^2}$	Note B	$\frac{ D }{\sum C}$	I*F Note C	J*E*sqrt(2) Note D	K^2 + L^2	
5.E Other (Biogas burning)	CH4	0.00	0.00	10.0	150.0	150.3330	0.0000	0.0000	0.0000	0.0000	0.0000	0.00000	
1.A.1 Energy industries - Liquid fuels	N2O	9.52	1.78	1.4	78.3	78.3347	0.0000	0.0001	0.0000	0.0064	0.0001	0.00004	
1.A.1 Energy industries - Solid fuels	N2O	33.63	3.04	2.2	60.0	60.0833	0.0000	0.0003	0.0000	0.0202	0.0001	0.00041	
1.A.1 Energy industries - Gaseous fuels	N2O	0.00	65.02	0.9	72.0	72.0161	0.0087	0.0010	0.0010	0.0703	0.0013	0.00494	
1.A.1 Energy industries - Other fossil fuels	N2O	0.00	6.64	5.0	100.0	100.1249	0.0002	0.0001	0.0001	0.0100	0.0007	0.00010	
1.A.1 Energy industries - Biomass	N2O	0.00	22.52	11.4	52.2	53.4659	0.0006	0.0003	0.0003	0.0177	0.0055	0.00034	
1.A.2 Manufacturing industries and construction - Liquid fuels	N2O	46.16	27.56	3.7	20.9	21.2550	0.0001	0.0001	0.0004	0.0023	0.0021	0.00001	
1.A.2 Manufacturing industries and construction - Solid fuels	N2O	4.27	0.17	1.1	81.5	81.5094	0.0000	0.0000	0.0000	0.0037	0.0000	0.00001	
1.A.2 Manufacturing industries and construction - Gaseous fuels	N2O	0.00	19.45	0.8	35.6	35.5722	0.0002	0.0003	0.0003	0.0104	0.0003	0.00011	
1.A.2 Manufacturing industries and construction - Other fossil fuels	N2O	0.08	9.31	6.1	167.2	167.3172	0.0010	0.0001	0.0001	0.0232	0.0012	0.00054	
1.A.2 Manufacturing industries and construction - Biomass	N2O	61.42	54.46	9.0	100.1	100.4562	0.0118	0.0001	0.0008	0.0121	0.0104	0.00025	
1.A.3.a Civil (domestic) aviation	N2O	1.32	2.52	35.5	498.3	499.5797	0.0006	0.0000	0.0000	0.0114	0.0019	0.00013	
1.A.3.b Road Transportation	N2O	69.85	138.83	2.5	2.5	3.5041	0.0001	0.0013	0.0021	0.0032	0.0072	0.00006	
1.A.3.c Railways - Liquid fuels	N2O	18.11	2.76	2.9	141.9	141.9322	0.0001	0.0002	0.0000	0.0233	0.0002	0.00054	
1.A.3.d Domestic navigation - Residual fuel oil	N2O	1.82	1.44	38.0	384.3	386.2107	0.0001	0.0000	0.0000	0.0003	0.0012	0.00000	
1.A.4 Combustion Other Sectors - Liquid fuels	N2O	51.70	61.32	1.0	115.9	115.8696	0.0199	0.0003	0.0009	0.0387	0.0013	0.00150	
1.A.4 Combustion Other Sectors - Gaseous fuels	N2O	0.00	5.85	0.1	0.3	0.2795	0.0000	0.0001	0.0001	0.0000	0.0000	0.00000	
1.A.4 Combustion Other Sectors - Biomass	N2O	141.15	82.71	0.0	0.1	0.1480	0.0000	0.0004	0.0012	0.0001	0.0001	0.00000	
1.A.5 Combustion Non-SpecifiedOther - Liquid fuels	N2O	0.71	0.54	5.0	50.0	50.2494	0.0000	0.0000	0.0000	0.0000	0.0001	0.00000	
1.B.2.c Venting and Flaring	N2O	2.09	1.91	28.6	465.5	466.3960	0.0003	0.0000	0.0000	0.0023	0.0012	0.00001	



National Inventory Report - Portugal



IPCC category/Group	Gas	Base year emissions or removals	Year x emissions or removals	Activity data uncertainty (1)	Emission factor / estimation parameter uncertainty (1)	Combined uncertainty	Contribution to variance by category in year x	Type A sensitivity	Type B sensitivity	Uncertainty in trend in national emissions introduced by emission factor / estimation parameter uncertainty (2)	Uncertainty in trend in national emissions introduced by activity data uncertainty (3)	Uncertainty introduced into the trend in total national emissions	Comments
		Gg CO2 equivalent	Gg CO2 equivalent	%	%	%		%	%	%	%	%	
		input data	input data	input data Note A	input data Note A	$\sqrt{E^2 + F^2}$	$\frac{(G \cdot D)^2}{(\sum D)^2}$	Note B	$\frac{D}{\sum C}$	I*F Note C	J*E*sqrt(2) Note D	K^2 + L^2	
2.B.2 Chemical Industry - Nitric acid production	N2O	460.40	33.23	2.0	10.0	10.1980	0.0000	0.0047	0.0005	0.0472	0.0014	0.00223	KC
2.G Other product manufacture and use	N2O	73.72	27.29	5.0	0.0	5.0000	0.0000	0.0004	0.0004	0.0000	0.0029	0.00001	
3.B Manure Management	N2O	238.76	201.27	38.7	55.7	67.7842	0.0735	0.0003	0.0030	0.0174	0.1652	0.02760	
3.D.1 Direct N2O Emissions From Managed Soils	N2O	1599.82	1551.63	20.5	80.5	83.0411	6.5518	0.0051	0.0233	0.4139	0.6745	0.62627	KC
3.D.2 Indirect N2O Emissions From Managed Soils	N2O	439.42	387.36	94.2	117.7	150.7763	1.3462	0.0008	0.0058	0.0977	0.7751	0.61026	KC
3.F Field burning of agricultural residues	N2O	2.52	1.75	43.6	47.6	64.5326	0.0000	0.0000	0.0000	0.0001	0.0016	0.00000	
4.A.1. Forest land remaining Forest land	N2O	152.41	86.73	8.8	53.8	54.5178	0.0088	0.0004	0.0013	0.0230	0.0162	0.00079	
4.A.2 Land converted to Forest land	N2O	18.08	12.81	8.8	35.6	36.6295	0.0001	0.0000	0.0002	0.0005	0.0024	0.00001	
4.B.1. Cropland remaining Cropland	N2O	24.49	3.62	12.0	59.2	60.3873	0.0000	0.0002	0.0001	0.0132	0.0009	0.00018	
4.B.2 Land converted to Cropland	N2O	29.21	53.58	8.8	43.7	44.5616	0.0022	0.0005	0.0008	0.0207	0.0100	0.00053	
4.C.1. Grassland remaining Grassland	N2O	53.88	18.13	22.5	103.8	106.1803	0.0015	0.0003	0.0003	0.0352	0.0087	0.00131	
4.C.2 Land converted to Grassland	N2O	0.00	8.71	11.3	52.0	53.1681	0.0001	0.0001	0.0001	0.0068	0.0021	0.00005	
4.D.2 Land converted to Wetlands	N2O	0.00	0.03	0.0	0.0	0.0000	0.0000	0.0000	0.0000	0.0000	0.0000	0.00000	
4.E.2 Land converted to Settlements	N2O	30.74	24.03	0.0	0.0	0.0000	0.0000	0.0000	0.0004	0.0000	0.0000	0.00000	
4.F.2 Land converted to Other Land	N2O	13.23	11.05	0.0	0.0	0.0000	0.0000	0.0000	0.0002	0.0000	0.0000	0.00000	
4(IV) Indirect nitrous oxide (N2O)	N2O	0.00	0.00	14.3	51.4	53.3076	0.0000	0.0000	0.0000	0.0000	0.0000	0.00000	
5.B Biological treatment of solid waste	N2O	292.90	385.51	0.0	0.0	0.0000	0.0000	0.0025	0.0058	0.0000	0.0000	0.00000	KC
5.C Incineration and open burning of waste	N2O	3.20	43.48	14.1	112.5	113.3854	0.0096	0.0006	0.0007	0.0694	0.0131	0.00498	
5.D Wastewater treatment and discharge	N2O	20.55	16.24	12.9	40.7	42.7348	0.0002	0.0000	0.0002	0.0004	0.0044	0.00002	
5.E Other (Biogas burning)	N2O	177.85	168.48	7.4	500.6	500.6397	2.8077	0.0005	0.0025	0.2561	0.0265	0.06629	KC
2.F.1 Refrigeration and Air Conditioning	Fgases	0.00	0.00	10.0	1000.0	1000.0500	0.0000	0.0000	0.0000	0.0000	0.0000	0.00000	



National Inventory Report - Portugal



IPCC category/Group	Gas	Base year emissions or removals	Year x emissions or removals	Activity data uncertainty (1)	Emission factor / estimation parameter uncertainty (1)	Combined uncertainty	Contribution to variance by category in year x	Type A sensitivity	Type B sensitivity	Uncertainty in trend in national emissions introduced by emission factor / estimation parameter uncertainty (2)	Uncertainty in trend in national emissions introduced by activity data uncertainty (3)	Uncertainty introduced into the trend in total national emissions	Comments Key Category (KC)
		Gg CO2 equivalent	Gg CO2 equivalent	%	%	%	%	%	%	%	%	%	
		input data	input data	input data Note A	input data Note A	$\sqrt{E^2 + F^2}$	$\frac{(G \cdot D)^2}{(\sum D)^2}$	Note B	$\frac{ D }{\sum C}$	I*F Note C	J*E*sqrt(2) Note D	K^2 + L^2	
2.F.2 Foam blowing agents	Fgases	0.00	51.98	45.6	32.5	56.0152	0.0033	0.0008	0.0008	0.0253	0.0504	0.00318	
2.F.3 Fire protection	Fgases	0.00	98.56	42.4	21.2	47.4217	0.0086	0.0015	0.0015	0.0313	0.0888	0.00886	
2.F.4 Aerosols	Fgases	0.00	16.07	30.0	50.0	58.3095	0.0003	0.0002	0.0002	0.0121	0.0102	0.00025	
2.G.1 Electrical equipment	Fgases	0.00	24.20	10.0	58.3	59.1608	0.0008	0.0004	0.0004	0.0212	0.0051	0.00048	
END													
Total		66610.92	50338.35				61.00					50.95	
Total Uncertainties						Uncertainty in total inventory %:	7.81				Trend uncertainty %:	7.14	

1 Totals exclude indirect CO2.



Annex G: Identification of Organic Soils in Portugal

Portugal currently reports Organic Soils as NO (Not Occurring). This Annex presents the information that supports that assessment.

G.1 Definition of Organic Soils

The 2006 IPCC Guidelines for National Greenhouse Gas Inventories define organic soils¹ as:

Organic soils are identified on the basis of criteria 1 and 2, or 1 and 3 listed below (FAO 1998):

1. *Thickness of organic horizon greater than or equal to 10 cm. A horizon of less than 20 cm must have 12 percent or more organic carbon when mixed to a depth of 20 cm.*
2. *Soils that are never saturated with water for more than a few days must contain more than 20 percent organic carbon by weight (i.e., about 35 percent organic matter).*
3. *Soils are subject to water saturation episodes and has either:*
 - a. *At least 12 percent organic carbon by weight (i.e., about 20 percent organic matter) if the soil has no clay; or*
 - b. *At least 18 percent organic carbon by weight (i.e., about 30 percent organic matter) if the soil has 60% or more clay; or*
 - c. *An intermediate, proportional amount of organic carbon for intermediate amounts of clay.*

The 2019 Refinement to the 2006 IPCC Guidelines for National Greenhouse Gas Inventories provide a different definition and define organic soils² as:

Organic soils are found in wetlands or have been drained and converted to other land-use types (e.g., Forest Land, Cropland, Grassland, Settlements). Soils having organic material (Histosols) are defined as (WRB, 2015):

1. *Starting at the soil surface and having a thickness of ≥ 10 cm and directly overlying:*
 - a. *Ice, or*
 - b. *Continuous rock or technic hard material, or*
 - c. *Coarse fragments, the interstices of which are filled with organic material; or*
2. *Starting ≤ 40 cm from the soil surface and having within ≤ 100 cm of the soil surface a combined thickness of either:*
 - a. *≥ 60 cm, if $\geq 75\%$ (by volume) of the material consists of moss fibres; or*
 - b. *≥ 40 cm in other materials*

All other types of soils are classified as mineral.

Portugal does not have a country wide soil map(s) that allow the identification of organic soils using those definitions.

However there are other information sources that provide some insight as to the possible existence of organic soils in Portugal. These are described in the next sections of this annex.

¹ Please refer to the 2006 IPCC Guidelines for National Greenhouse Gas Inventories, Volume 4 AFOLU, Chapter 3 Consistent Representation of Lands, Annex 3A.5 Default climate and soil classifications, page 3-37.

² Please refer to the 2019 Refinement to the 2006 IPCC Guidelines for National Greenhouse Gas Inventories, Volume 4 AFOLU, Chapter 3 Consistent Representation of Lands, Annex 3A.5 Default climate and soil classifications, page 3-45.



G.2 FAO / Harmonized World Soil Database

The Harmonized World Soil Database³ is the result of a collaboration between the FAO with IIASA, ISRIC-World Soil Information, Institute of Soil Science, Chinese Academy of Sciences (ISSCAS), and the Joint Research Centre of the European Commission (JRC).

The database contains over 15 000 different soil mapping units that combines existing regional and national updates of soil information worldwide (SOTER, ESD, Soil Map of China, WISE) with the information contained within the 1:5 000 000 scale FAO-UNESCO Soil Map of the World (FAO, 1971-1981).

The information can be visualized using a Database Viewer⁴.

No Histosols can be found in Portugal in that map.



G.3 JRC – Topsoil Soil Organic Carbon (LUCAS) for EU25

This dataset (2015) was created by the Joint Research Centre of the EU and provides maps for Topsoil Soil Organic Carbon in EU-25 that are based on LUCAS 2009 soil point data through a generalized additive model.

The map of predicted topsoil organic carbon content (gCkg^{-1}) was produced by fitting a generalised additive model between organic carbon measurements from the LUCAS survey (dependent variable) and a set of selected environmental covariates; namely slope, land cover, annual accumulated temperature, net primary productivity, latitude and longitude.

The map does not show any areas over 12% C (120 gCkg^{-1}) in Portugal.

³ Available from <http://www.fao.org/soils-portal/soil-survey/soil-maps-and-databases/harmonized-world-soil-database-v12/en/>

⁴ Harmonized World Soil Database Viewer, Version 1.21, March 2012.



National Inventory Report - Portugal

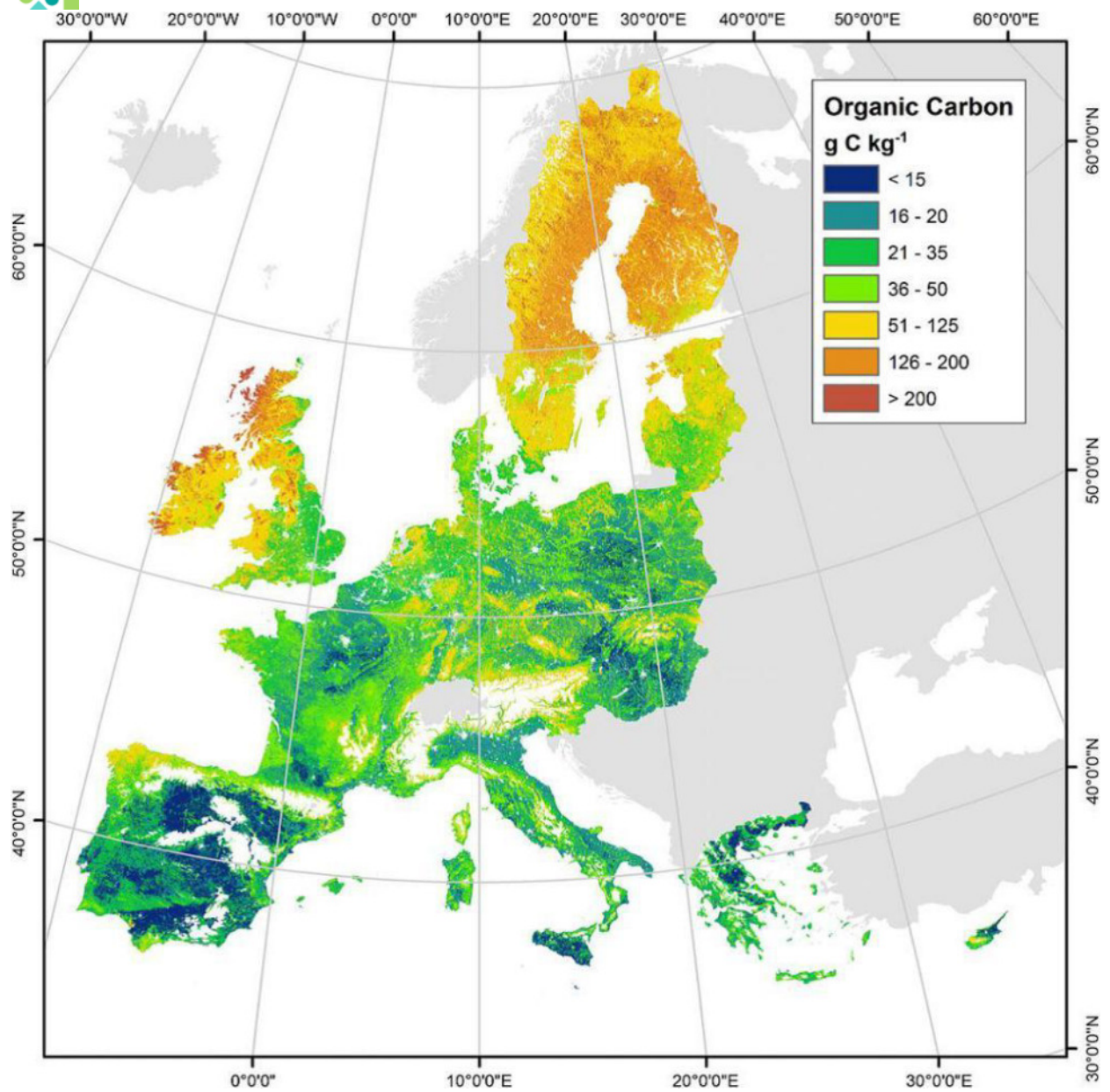



Annex H: Activity data for HWP

Consistently with other sectors, Table4.Gs2 provides data only from 1990 onwards. However, HWP emissions and removals are affected by Carbon Stocks accumulated since 1970.

As explained in section 6.8 Harvested Wood Products (CRF 4.G), data is available from UNECE for the period 1964-2020.

The production of HWP that came from domestic harvest was estimated using IPCC equation 12.4. For transparency, the full time series is presented in this annex.



National Inventory Report - Portugal



			1970	1971	1972	1973	1974	1975	1976	1977	1978	1979	1980	1981	1982	1983	1984	1985	1986	1987	1988	1989
Industrial Roundwood	Production	1.000 m3	5 250,00	5 385,00	5 530,00	5 595,00	5 225,00	5 056,00	4 988,00	5 899,00	6 300,00	6 983,00	7 396,00	6 880,00	6 643,00	7 019,00	7 849,00	8 792,00	9 326,00	8 822,00	8 839,00	9 705,00
	Imports	1.000 m3	160,80	253,90	248,70	411,70	317,10	334,60	354,30	504,10	249,30	171,70	297,60	475,49	451,00	304,80	327,60	388,00	440,00	464,00	886,00	820,00
	Exports	1.000 m3	237,50	104,30	72,00	172,30	216,00	76,80	134,29	144,90	458,80	950,50	621,00	283,80	243,00	181,10	339,10	619,00	481,00	533,00	447,00	534,00
	wood from domestic production	%	97%	95%	96%	93%	94%	94%	93%	92%	96%	97%	96%	93%	93%	96%	96%	95%	95%	95%	90%	92%
Wood Pulp	Production	1.000 t	427,40	474,10	516,00	536,00	591,00	547,00	462,00	494,00	600,00	698,90	645,00	685,00	870,10	950,40	988,00	1 306,00	1 375,00	1 408,00	1 472,00	1 482,00
	Imports	1.000 t	29,40	17,10	16,70	19,39	17,89	13,80	22,70	79,30	39,00	44,59	42,80	33,79	21,00	15,60	23,40	44,80	39,70	37,00	29,00	37,50
	Exports	1.000 t	340,30	291,90	459,20	464,10	363,29	264,79	359,50	317,60	290,60	346,00	445,40	454,80	515,00	610,90	661,90	878,60	890,00	1 013,00	1 017,00	1 003,09
	pulp from domestic production	%	75%	91%	77%	79%	93%	95%	82%	69%	89%	89%	82%	87%	94%	96%	93%	91%	92%	91%	94%	93%
Sawnwood	Production	1.000 m3	1 810,00	1 870,00	1 990,00	2 210,00	1 840,00	1 600,00	1 820,00	1 930,00	1 970,00	2 240,00	2 270,00	1 870,00	2 229,00	2 360,00	2 606,00	1 860,00	2 070,00	2 095,00	2 088,00	2 140,00
	Imports	1.000 m3	34,69	37,20	37,90	37,30	46,70	27,80	12,70	18,80	11,80	8,60	12,00	34,00	36,00	17,20	17,40	18,80	27,00	34,00	64,00	70,00
	Exports	1.000 m3	479,40	445,60	457,60	590,10	585,79	332,10	549,60	626,19	649,40	884,90	1 024,00	787,09	881,00	896,50	1 194,09	1 062,90	1 168,00	1 043,00	1 365,00	1 405,00
	wood from domestic production	%	173,20	175,30	256,80	241,50	262,50	227,50	315,70	388,10	399,69	416,00	472,00	493,00	471,00	522,30	495,69	657,00	776,00	827,00	851,00	1 035,00
Wood panels	Imports	1.000 m3	1,90	2,10	2,10	3,50	7,60	21,10	18,50	17,44	22,54	38,70	38,24	38,40	1,20	0,60	0,70	1,10	5,00	11,00	8,00	19,00
	Exports	1.000 m3	82,29	103,40	103,20	82,60	36,90	45,40	46,90	34,00	101,10	193,90	172,40	147,40	120,90	241,70	319,69	430,90	511,00	560,00	569,00	628,70
	Production	1.000 t	219,50	236,60	228,10	253,70	310,00	357,00	336,50	449,20	438,50	492,99	463,20	484,50	527,00	592,00	670,50	706,00	589,79	627,00	681,00	740,00
	Imports	1.000 t	76,00	62,90	72,00	78,30	75,20	46,80	39,90	62,30	52,49	58,00	78,40	75,59	82,00	78,70	81,59	100,60	126,30	182,50	220,00	250,60
Paper and paperboard	Exports	1.000 t	11,70	15,00	16,70	26,40	61,90	105,90	129,10	116,90	117,00	168,00	147,00	146,00	161,00	194,70	214,70	216,90	204,60	174,40	208,00	238,50

			1990	1991	1992	1993	1994	1995	1996	1997	1998	1999	2000	2001	2002	2003	2004	2005	2006	2007	2008	2009
Industrial Roundwood	Production	1.000 m3	10 705,00	10 309,00	9 778,00	9 707,00	9 319,00	8 850,00	8 428,00	8 428,00	7 948,00	8 378,00	10 231,00	8 346,00	8 142,00	9 073,00	10 269,00	10 146,23	10 204,63	10 222,88	9 568,74	8 964,06
	Imports	1.000 m3	741,40	519,10	559,40	419,86	1 105,00	1 632,00	1 065,00	1 679,00	2 121,80	1 432,00	1 340,42	1 109,00	901,00	468,00	364,00	362,00	335,00	746,00	521,37	472,82
	Exports	1.000 m3	402,00	429,00	549,10	361,00	629,00	778,00	452,00	627,00	572,00	543,00	556,92	809,00	820,00	1 018,00	1 009,00	1 274,00	1 422,00	1 526,00	1 344,71	602,37
	wood from domestic production	%	93%	95%	94%	96%	89%	83%	88%	82%	78%	85%	88%	87%	89%	95%	96%	96%	96%	92%	94%	95%
Wood Pulp	Production	1.000 t	1 449,00	1 619,00	1 592,00	1 520,00	1 539,00	1 617,00	1 595,00	1 703,00	1 708,00	1 755,00	1 774,00	1 806,00	1 929,00	1 935,00	1 949,00	1 990,00	2 065,00	2 092,17	2 021,75	2 066,63
	Imports	1.000 t	49,80	59,70	63,97	64,08	72,40	73,80	89,39	114,00	96,50	99,00	94,23	163,00	144,50	133,00	112,00	75,98	68,00	82,43	84,71	92,31
	Exports	1.000 t	1 057,30	1 092,00	1 040,95	905,53	1 060,00	970,50	1 009,70	1 087,00	1 070,15	1 145,00	969,09	980,00	962,00	961,00	933,00	762,00	1 038,04	1 040,00	945,25	1 149,27
	pulp from domestic production	%	89%	90%	90%	91%	87%	90%	87%	84%	87%	86%	90%	84%	87%	88%	90%	94%	94%	93%	93%	91%
Sawnwood	Production	1.000 m3	2 140,00	1 720,00	1 650,00	1 594,00	1 770,00	1 831,00	1 831,00	1 831,00	1 590,00	1 430,00	1 427,00	1 492,00	1 298,00	1 383,00	1 060,00	1 010,00	1 010,00	1 010,81	1 009,78	1 093,07
	Imports	1.000 m3	80,00	96,00	194,42	136,99	131,00	153,00	162,00	190,00	230,40	273,00	297,22	252,00	262,00	263,00	280,00	333,00	258,00	302,00	202,76	129,18
	Exports	1.000 m3	1 114,00	1 425,00	1 091,69	473,55	568,00	525,00	460,00	407,00	428,30	339,00	283,37	281,00	286,00	298,00	319,00	375,00	462,00	635,00	293,72	234,88
	wood from domestic production	%	1 242,00	1 246,00	1 064,00	1 000,00	1 230,00	1 170,09	1 215,70	1 208,30	1 242,90	1 293,00	1 243,00	1 250,00	1 215,00	1 232,00	1 306,00	1 306,00	1 306,00	1 337,08	1 352,43	1 385,17
Wood panels	Imports	1.000 m3	46,80	82,30	144,35	144,85	114,00	117,90	114,20	116,60	136,09	163,00	246,00	264,00	268,00	231,00	242,00	301,00	381,00	620,00	597,44	517,36
	Exports	1.000 m3	786,40	728,90	747,44	576,36	738,00	647,39	635,58	862,40	778,00	671,60	747,50	652,00	715,00	796,00	914,00	963,00	914,00	943,00	776,00	984,44
	Production	1.000 t	780,00	877,00	959,00	878,00	949,00	1 050,00	1 086,00	1 114,00	1 136,00	1 163,00	1 290,00	1 419,00	1 537,00	1 530,00	1 664,00	1 570,00	1 644,00	1 643,76	1 661,61	1 633,80
	Imports	1.000 t	294,60	258,39	334,21	408,44	447,00	657,70	674,50	735,70	564,20	573,00	643,56	642,00	668,00	696,00	783,00	757,00	736,00	836,00	777,81	804,11
Paper and paperboard	Exports	1.000 t	289,50	336,70	332,10	456,33	601,20	583,47	631,71	721,75	642,93	683,00	744,41	792,13	980,51	1 172,28	1 045,16	1 227,54	1 079,33	1 325,32	1 284,01	1 360,24

			2010	2011	2012	2013	2014	2015	2016	2017	2018	2019	2020
Industrial Roundwood	Production	1.000 m3	9 048,36	10 361,41	10 110,81	10 009,58	10 552,37	10 799,67	12 011,40	12 517,16	12 045,60	12 274,16	11 692,40
	Imports	1.000 m3	855,32	1 716,72	1 643,96	2 319,65	2 599,75	2 013,56	2 130,54	2 042,47	2 010,07	2 051,16	2 558,47
	Exports	1.000 m3	1 000,86	1 125,22	1 000,30	1 256,77	1 036,78	318,34	298,40	510,50	500,21	429,38	261,86
	wood from domestic production	%	90%	84%	85%	79%	79%	84%	85%	85%	85%	85%	82%
Wood Pulp	Production	1.000 t	1 837,51	2 265,10	2 452,03	2 536,67	2 625,89	2 660,90	2 729,10	2 752,90	2 772,90	2 744,90	2 683,10
	Imports	1.000 t	34,78	94,49	94,74	122,16	122,87	124,95	152,30	171,75	176,39	162,08	142,98
	Exports	1.000 t	830,92	1 013,36	1 080,69	1 165,93	1 144,19	1 189,83	1 238,61	1 179,16	1 169,79	1 255,25	1 329,49
	pulp from domestic production	%	97%	93%	94%	92%	92%	92%	91%	90%	90%	90%	90%
Sawnwood	Production	1.000 m3	1 044,85	1 044,42	941,55	854,02	1 034,80	1 134,25	1 085,15	979,15	1 135,90	1 034,99	690,00
	Imports	1.000 m3	208,38	154,34	146,64	126,12	145,75	167,00	185,81	171,19	225,08	229,16	228,95
	Exports	1.000 m3	296,14	443,54	340,15	615,51	394,97	352,45	308,61	382,26	382,58	363,99	258,81
	wood from domestic production	%	1 363,46	1 380,02	1 474,63	1 169,15	1 307,91	1 312,10	1 184,32	1 109,77	1 153,68	1 234,06	1 219,06
Wood panels	Imports	1.000 m3	416,31	480,40	478,96	595,53	517,91	514,95	636,31	897,23	1 016,68	984,80	809,26
	Exports	1.000 m3	509,77	721,87	859,19	896,68	1 017,44	934,61	848,96	861,75	816,24	1 035,98	902,98
	Production	1.000 t	1 456,47	2 180,10	2 120,12	2 129,03	2 187,00						



Annex I: WG1-indirect emissions

Version 19.1.2016

Guidance related to the reporting of indirect emissions

The initial checks of the 2015 inventories have discovered differences in the ways indirect emissions are reported in GHG inventories across the EU in the new CRF reporter software and revised CRF tables and IPCC Guidance. In addition MS approached WG1 with questions regarding the reporting of indirect emissions. This paper intends to offer some additional guidance related to the reporting of indirect emissions. It provides details on how countries reported information on indirect gases in the 2015 inventories, at the gas level (CO₂, N₂O) and provides recommendations for submission of the information in 2016. This guidance is also related to the treatment of indirect emissions in the calculation of the assigned amount for the second commitment period under the Kyoto Protocol.

1. Indirect CO₂ emissions

1.1 Background

The CO₂ resulting from the atmospheric oxidation of CH₄, CO and NMVOC is referred to as indirect CO₂. Indirect CO₂ resulting from the oxidation of CH₄, CO and NMVOCs produced by fossil fuel combustion are included in the general methodological approach which assumes that all the carbon in the fuel (minus the portion that remains as soot or ash) is oxidized to CO₂ whereas actually a fraction of this carbon is initially emitted as CH₄, CO or NMVOC.

Other sources of indirect CO₂ emissions are not yet captured by the general inventory methodologies. Sources mentioned in the 2006 IPCC Guidelines are:

- Fugitive emissions from energy use, e.g. NMVOC emissions from oil refineries, storage of chemicals at refineries, road traffic evaporative emissions from cars, emissions from gasoline distribution network and refueling of cars, ships and aircrafts, CH₄ emissions from natural gas transmission and distribution or coke production.
- Carbon from Non-energy products from fuels and solvent use in IPPU: The production and use of asphalt for road paving and roofing and the use of solvents derived from petroleum and coal are sometimes substantial sources of NMVOC and CO emissions which oxidise to CO₂ in the atmosphere. The resulting CO₂ input can be estimated from the emissions of these non-CO₂ gases.
- AFOLU emissions where non-CO₂ gases have been explicitly deducted (Such NMVOC emissions are considered as biogenic in MS reporting and resulting indirect CO₂ emissions are not included in MS GHG inventories).

2006 IPCC Guidelines provide a method how the CO₂ inputs from the atmospheric oxidation of CH₄, CO or NMVOC can be calculated. The basic calculation principles are (2006 IPCC Guidelines, Volume 1, Chapter 7, p. 7.6):



From CH ₄ :	$Inputs_{CO_2} = Emissions_{CH_4} \cdot 44/16$
From CO:	$Inputs_{CO_2} = Emissions_{CO} \cdot 44/28$
From NMVOC:	$Inputs_{CO_2} = Emissions_{NMVOC} \cdot C \cdot 44/12$
Where C is the fraction carbon in NMVOC by mass (default = 0.6)	

The default fossil carbon content fraction of NMVOC is **60 percent by mass**, based on limited published national analyses of the speciation profile (U.S. EPA, 2002; Austria, 2004; Hungary, 2004; Klein Goldewijk et al., 2005). It may vary between 50 and 70 percent carbon by mass, so having an uncertainty of about ±10 percent (2006 IPCC Guidelines, Volume 3, p. 5.17).

The default fossil C content fraction of NMVOCs **from asphalt production and road paving** is provided with **80%** calculates based on the NMVOC specification provided in the EMEP/CORINAIR Emission Inventory Guidebook (2006 IPCC Guidelines, Volume 3, p. 5.16).

The carbon content in NMVOCs varies as this group includes a large variety of chemically different compounds. 2006 IPCC Guidelines provide for the first time a default factor for the fraction of Carbon in NMVOC (0.6). However, an inventory based on the speciation of the NMVOC compounds and their C content provides more accurate results. Some countries justified the non-estimation of indirect CO₂ emissions from NMVOCs in the past with the lack of such default C fraction.

In the calculation of indirect CO₂, only fossil carbon should be considered, indirect CO₂ should not be calculated for precursors originating from biomass combustion in line with IPCC guidance, nor from other biogenic sources, e.g. agriculture, pulp and paper, food and drink production, wood industry.

1.2 UNFCCC legal provisions and IPCC guidance

According to paragraph 29 of the UNFCCC reporting guidelines for GHG inventories (Annex I to decision 24/CP.19) *“Annex I Parties may report indirect CO₂ from the atmospheric oxidation of CH₄, CO and NMVOCs. For Parties that decide to report indirect CO₂ the national totals shall be presented with and without indirect CO₂”*.

Para 37(b) the UNFCCC reporting guidelines states: *“Once emissions from a specific category have been reported in a previous submission, emissions from this specific category shall be reported in subsequent GHG inventory submissions.”*

Reporting of indirect CO₂ emissions is not mandatory (“may” in paragraph 29), however in combination with paragraph 37(b) those countries that included indirect CO₂ emissions in the past in their GHG inventories, shall continue to report indirect CO₂ emissions in their inventory.

An assessment of the 2015 inventory submissions indicates that 5 MS do not report any indirect CO₂ emissions while 23 MS report indirect CO₂ emissions. This is not completely clear from the NIRs and the CRF tables because indirect CO₂ emissions can be reported combined with direct CO₂ emissions. Some MS state in chapter 9 of the NIR that their inventory does not include indirect CO₂ emissions, but nevertheless in the IPPU chapter it is explained how indirect CO₂ emissions from solvent use were estimated.

The CRF summary table 2 produces two national totals without LULUCF: (1) 'Total CO₂ equivalent emissions without land use, land-use change and forestry' (2) 'Total CO₂ equivalent emissions, including indirect CO₂, without land use, land-use change and forestry'. In addition summary table 2 includes a separate row for indirect CO₂ emissions. Only those indirect CO₂ emissions reported in table 6 are part of the row for indirect CO₂ and are deducted from national totals in the row that excludes indirect CO₂ emissions.



1.3 Where should indirect CO₂ emissions be reported in CRF tables?

There are several options where indirect CO₂ emissions can be reported in the CRF tables:

1. In the sectoral categories where NMVOC emissions or CH₄ emissions occur that lead to indirect CO₂ emissions. These are in particular the **source category 2.D.3 Other in IPPU Table 2(I)s2 and 2(I).A-Hs2** where the CRF reporter software contains pre-defined subcategories for solvent use, road paving with asphalt and asphalt roofing. Indirect CO₂ emissions could also be included in other source categories and tables, e.g. in table 1.B.2 Oil, natural gas and other emissions from energy production.
2. The new **CRF table 6** cross sectoral report: Indirect emissions of N₂O and CO₂. This table only allows reporting at sectoral level (energy, IPPU, agriculture, LULUCF, waste, other) and no distinction of any source categories and the reporting in this table is therefore not very transparent as it only provides information that indirect CO₂ emissions have been estimated in some sectors.

2006 IPCC Guidelines recommend the reporting of indirect emissions from solvent use and production and use of asphalt in the IPPU sector under the categories 2.D. Other:

- Volume 3, p. 5.16: The relatively small emissions from production and use of asphalt, including asphalt blowing, should be reported under the subcategory 2D4 'Other' of this source category 2D 'Non-Energy Products from Fuels and Solvent Use'. Emissions from any other non-energy product of fossil fuels not described here should be reported under the subcategory 2D4 'Other' (Volume 3, chapter 5, p. 5.5)

2006 IPCC Guidelines also stress the relationship between the 2.D. categories and the consistency and completeness of emissions from non-energy and feedstock use of fuels:

Non energy product use of fuels and other chemical products resulting in NMVOC and CO emissions (based on table 5.1 of Volume 3, chapter 5, p. 5.6):

Types of fuels used	Examples of non-energy use
Bitumen; road oil and other petroleum diluents	Used in asphalt production for road paving and e.g., in roofing; 2006 IPCC GL, Vol. 3, Ch.5, Section 5.4
White spirit, kerosene, some aromatics	As solvent e.g. for surface coating (paint), dry cleaning; 2006 IPCC GL, Vol. 3, Ch.5, Section 5.5

With regard to the verification of completeness of fossil CO₂ from non-energy sources 2006 IPCC Guidelines recommend:

- checking that total reported bottom-up calculated CO₂ emissions from non-energy use/feedstock sources at different subcategory levels are complete and consistent,
- documenting and reporting how these emissions are allocated in the inventory.

When indirect CO₂ emissions are reported in CRF table 6, they appear in a separate line in summary table 2 and the total emissions can be separated in a total with and a total without indirect CO₂ emissions.

When indirect CO₂ emissions are reported in **IPPU background tables Table 2(I)s2 and 2(I).A-Hs2** or other sectoral tables these emissions are aggregated with other CO₂ emissions and are not separated in the



national total. This reporting therefore contradicts the requirement that Parties that decide to report indirect CO₂ the national totals shall be presented with and without indirect CO₂.

However, when indirect CO₂ emissions from 2.D.3 Other are reported in CRF table 6, Parties do not follow the reporting guidance provided in 2006 IPCC Guidelines and UNFCCC guidance (paragraph 35 of Annex I to decision 24/CP.19) related to the tracking of the non-energy use: “Annex I Parties should clearly indicate how feedstocks and non-energy use of fuels have been accounted for in the inventory, under the energy or industrial processes sector, in accordance with the 2006 IPCC Guidelines.”

Thus, thus both options have limitations and there doesn't seem to be a clear solution.

1.4 MS reporting in 2015 submission

Table 2 presents an overview of the reporting of MS of indirect CO₂ emissions. 7 Member States (BE; CY, GB, GR, MT, HU, SI) did not report indirect CO₂ emissions in the 2015 submission.⁵ Cyprus, Greece and Hungary had reported indirect CO₂ emissions from solvents in previous inventories (e.g. 2014 submission) in Table 3.A-D.

Table 2 MS reporting of indirect CO₂ emissions in 2015 GHG inventories

	2015 submission (for year 2012)				2014 submission for year 2012	
	Table 2(I)s2 and 2(I).A-Hs2		Table 6	Other tables/ categories	Table 3 3.A-3.D	Table 2(I).A-G (2.A.5 Asphalt Roofing, 2.A.g Road paving with asphalt)
	2.D.3 Solvent use	2.D.3 Road paving with asphalt, asphalt roofing				
AT	189 kt	IE	NA		189 kt	IE
BG	8 kt	IE	NO		22 kt	NO
CY	NE	NE	Blank cells		10 kt	NE
CZ	CO ₂ reported as NO, NMVOC reported	NE	indirect CO ₂ reported for energy, IPPU and waste 2071 kt		223 kt	NE
DE	1402 kt	NE	NE		1436 kt	NA
DK	68 kt	0.16 kt	indirect CO ₂ reported for energy, IPPU and waste		63 kt	1.78

⁵ This is not always completely clear, e.g. the Belgian NIR states that no estimation of indirect CO₂ from NMVOC from solvents has been carried out, but also states that category 1.A.1c includes indirect CO₂ emissions from coke ovens.



	2015 submission (for year 2012)			2014 submission for year 2012		
	Table 2(I)s2 and 2(I).A-Hs2		Table 6	Other tables/ categories	Table 3 3.A-3.D	Table 2(I).A-G (2.A.5 Asphalt Roofing, 2.A.g Road paving with asphalt)
	2.D.3 Solvent use	2.D.3 Road paving with asphalt, asphalt roofing				
			(sources not included in 2.D.3) 465.1 kt			
ES	766 kt	NA	NE		771 kt	NA
EE	CO2 reported as NO, NMVOC reported	CO2 reported as NO, NMVOC reported	indirect CO2 reported from IPPU 14 kt		14 kt	NO
FI	CO2 reported as NO, NMVOC reported	NO	indirect CO2 reported from energy and IPPU 48 kt	2.B.10 Chemical industry and storage of chemicals, 2.C.7 Iron and steel production, non-ferrous metal production 32 kt	40 kt	3 kt
FR	622 kt	Not specified in CRF	NMVOC reported, indirect CO2 reported from IPPU 1024 kt		1001 kt	NA
GR	NE	NO	NE		163 kt	NE
HR	41 kt	NA	NA		104 kt	NE



	2015 submission (for year 2012)			2014 submission for year 2012		
	Table 2(I)s2 and 2(I).A-Hs2		Table 6	Other tables/ categories	Table 3 3.A-3.D	Table 2(I).A-G (2.A.5 Asphalt Roofing, 2.A.g Road paving with asphalt)
	2.D.3 Solvent use	2.D.3 Road paving with asphalt, asphalt roofing				
HU	NE	NE	NE		74 kt	NA
IE	CO2 reported as NO, NMVOC reported	Not mentioned	indirect CO2 reported from IPPU 64 kt		73 kt	NE
IT	1165 kt	NO	NO		1001 kt	NE
LT	58 kt	0.01 kt	NO	1B2aiv Fugitive emissions oil: refining storage estimated, gasoline evaporation in 1A3bv 0.03 kt	81 kt	0.02 kt
LU	14 kt	Not mentioned	NO		9 kt	NO
LV	CO2 reported as NA, NMVOC reported	0.13 kt	indirect CO2 reported from IPPU 112 kt	Indirect CO2 from glass fibre production	49 kt	0.13 kt
NL	CO2 reported as IE, NMVOC reported	Not mentioned	indirect CO2 reported from IPPU 329 kt		120 kt	NE
PL	636 kt	Not mentioned	NA		636 kt	NA, NO



	2015 submission (for year 2012)			2014 submission for year 2012		
	Table 2(I)s2 and 2(I).A-Hs2		Table 6	Other tables/ categories	Table 3 3.A-3.D	Table 2(I).A- G (2.A.5 Asphalt Roofing, 2.A.g Road paving with asphalt)
	2.D.3 Solvent use	2.D.3 Road paving with asphalt, asphalt roofing				
PT	145 kt	2 kt	indirect CO ₂ reported from IPPU 184 kt	indirect CO ₂ emissions from fires: Indirect emissions are defined as those that not released during the forest fire but are attributed to fires, following tree mortality	190 kt	2.8 kt
RO	122 kt	NE	NO		128 kt	NE
SK	63 kt	NMVOC reported, but indirect CO ₂ NE	NO/NE		82 kt	NA
SE	184 kt	NMVOC reported, but indirect CO ₂ reported as NA	Empty cells		204 kt	NA

Source: 2015 GHG inventory submissions to the UNFCCC (CRF and NIR)

Table 2 provides an overview in which tables MS reported indirect CO₂ emissions, which notation keys were used and present the quantities reported for the reporting year 2012. The year 2012 was used in order to compare also with the 2014 submission whether the quantities reported changed or remained at similar level.



Table 2 shows that Member States chose the following approaches in the reporting of indirect CO₂ emissions:

- 9 Member States reported indirect CO₂ emissions in the new CRF table 6:
 - 4 Member States reported indirect CO₂ emissions in CRF table 6, but also indirect CO₂ emissions in table 2(i)s2 under 2.D.3 Solvent use or asphalt production and use (Denmark, France, Latvia, Portugal). Of these countries, Denmark reported indirect CO₂ emissions from solvent use and asphalt production and use which were also reported in previous years in table 2(i)s2 under 2.D.3, whereas additional indirect CO₂ emissions that were reported in the 2015 submission for the first time, were reported in table 6. For the other Member States that used both options, it is less clear which emissions were reported in table 6.
 - 5 Member States only used table 6 for the reporting of indirect CO₂ emissions (CZ, EE; FI, IE, NL). Of these Member States, EE, IE and NL only reported indirect CO₂ emissions from IPPU, whereas CZ reported indirect CO₂ emissions from energy, IPPU and waste and FI reported indirect CO₂ from energy and IPPU sectors. For EE the quantities reported in table 6 are similar to the quantities reported in the 2014 submission in table 3 under solvents use.
- 12 MS (AT, BE, DE, ES, FR, HR, IT, LU, PL, RO, SK, SE) reported indirect CO₂ emissions only in table 2(i)s2 under 2.D. Solvent Use, road paving with Asphalt and asphalt roofing. All of these MS reported indirect CO₂ emissions in the 2014 submission in table 3. For two MS (AT and PL), the reported quantities for the year 2012 are identical in the two submissions, for 6 MS, the reported quantities are similar (DE, ES, LU, RO, SK, SE).
- 1 MS reported indirect CO₂ emissions in table 2(i)s2 under 2.D. Solvent Use, road paving with Asphalt and asphalt roofing and in table 1.B.2 fugitive emissions from oil under oil refining and gasoline evaporation.
- Only three MS (CZ, FI, LT) reported indirect emissions from the energy sector (fugitive emissions of NMVOC). Reported indirect emissions in the IPPU sector are mostly emissions from solvent use.
- In table 6 all available notation keys and empty cells occur. The reporting of notation keys should be clarified and harmonized.

1.5 Recommendations

- Member States which were reporting indirect CO₂ emissions in inventory submissions before 2015 in previous CRF table 3 (Sectoral report for solvents and other products use) should continue reporting these emissions. It is recommended to report these indirect CO₂ emissions now in CRF table 2(i) under “2D Non-energy products from fuels and solvent use” which includes a predefined drop down lists in the CRF reporter under 2D3 Other for “solvent use”.
- Member States which were reporting indirect CO₂ emissions in CRF category 2A5 asphalt roofing and 2A6 Road paving with asphalt should continue reporting these emissions. It is recommended to report these indirect CO₂ emissions in CRF table 2(i) under “2D Non-energy products from fuels and solvent use” under 2D3 Other which includes a predefined drop down lists in the CRF reporter under 2D3 which includes predefined categories for “asphalt roofing” and “road paving with asphalt”.

This approach also ensures the highest possible consistency with the guidance provided in the IPCC 2006 Guidelines related to the reporting of “Non-energy products from fuels and solvent use” and the



description of reporting categories under 2D in Volume 1, chapter 8, table 8.2 of the 2006 IPCC Guidelines. This approach is also more transparent than the reporting in table 6 where indirect CO₂ emissions are aggregated at sectoral level.

- It is recommended that other indirect CO₂ emissions estimated in the energy sector, in the IPPU sector (apart from the categories described above) or in the waste sector, should be reported in table 6. The NIR should describe in more detail the specific sources and methodologies used for the emissions reported in table 6.
- If only indirect CO₂ emissions from solvents, or asphalt roofing/ road paving with asphalt are included in the inventory and no other indirect CO₂ emissions from the IPPU sector, Table 6 should be filled with the notation key 'IE' in the row for IPPU as some indirect CO₂ emissions are included in the IPPU tables.
- If no indirect CO₂ emissions are estimated in the energy and waste sectors, the notation key 'NE' seems to be appropriate for Table 6 in the rows for energy and waste because NMVOC inventories, 2006 IPCC Guidelines and the reporting of some MS show that indirect CO₂ emissions can occur in these sectors. Therefore NO or NA may not be the appropriate notation keys.
- The information provided in chapter 9 'indirect CO₂ and N₂O emission' in the NIR could be improved for some MS, in particular those that report emissions in CRF table 6 should provide information which sources have been estimated.

Linkages to KP reporting

- It is recommended to use the row "Total CO₂ equivalent emissions, including indirect CO₂, without land use, land-use change and forestry" in summary table 2 for the calculation of base year emissions and the assigned amount calculation in the initial report to facilitate the calculation of the assigned amount for the 2nd commitment period under the Kyoto Protocol. The reporting guidelines under the Kyoto Protocol do not clearly mention indirect CO₂ emissions. However, many countries included indirect CO₂ emissions in their KP reporting in the first commitment period which was never raised as a problem and Parties were even encouraged to report indirect CO₂ emissions by ERTs. Thus, from the 1st commitment period it can be assumed that indirect CO₂ emissions are part of the coverage of emissions under the KP. As this scope has not been changed, it is consistent with the reporting in CP1 to include indirect CO₂ emissions in the national total for the purposes of the Kyoto Protocol accounting.

2. Indirect N₂O emissions

1.1 Background

- Indirect N₂O emissions in the agriculture sector address nitrous oxide (N₂O) emissions that result from the deposition of the nitrogen emitted as NO_x and NH₃. N₂O is produced in soils through the biological processes of nitrification and denitrification. One of the main controlling factors in this reaction is the availability of inorganic nitrogen in the soil and therefore deposition of nitrogen resulting from NO_x and ammonia (NH₃) will enhance emissions.
- Revised 1996 IPCC Guidelines only estimated indirect N₂O emissions from agricultural sources of nitrogen. The 2006 Guidelines include guidance for estimating N₂O emissions resulting from nitrogen deposition of all anthropogenic sources of NO_x and NH₃ (in particular from sources in the energy and IPPU sectors).
- The 2006 IPCC Guidelines, Volume 5, also address indirect N₂O emissions which occur from the release of wastewater effluents into waterways, lakes or the sea.



1.2 UNFCCC legal provisions and IPCC guidance

UNFCCC guidelines:

- Related to indirect N₂O emissions, paragraph 29 of the UNFCCC reporting guidelines for GHG inventories states that the estimates of indirect N₂O from sources other than agriculture and LULUCF should not be included in national totals and “Annex I Parties may report as a memo item indirect N₂O emissions from other than the agriculture and LULUCF sources.” Thus, N deposition of NO_x and NH₃ from sources in the energy or IPPU sector should be excluded from national totals and included under the memo items in summary table 2. This is technically implemented in the CRF reporter if indirect N₂O emissions are reported in table 6. The indirect emissions reported in this table are those that appear under the memo items in the summary 2 table.
- Indirect N₂O emissions from agriculture and LULUCF sources have been included in the inventory in the past and countries should continue to report these emissions in the agriculture and/ or LULUCF sector. This refers to the following emission sources in the CRF tables and the 2006 IPCC Guidelines:
 - **Indirect N₂O emissions from managed soils in CRF table 3.D.**
 - (1) the volatilization of N (as NH₃ and NO_x) following the application of synthetic and organic N fertilizers and /or urine and dung deposition from grazing animals, and the subsequent deposition of the N as ammonium (NH₄⁺) and oxides of N (NO_x) on soils and waters, and
 - (2) the leaching and runoff of N from synthetic and organic N fertilizer additions, crop residues, mineralization /immobilization of N associated with loss/gain of soil C in mineral soils through land use change or management practices, and urine and dung deposition from grazing animals, into groundwater, riparian areas and wetlands, rivers and eventually the coastal ocean (2006 IPCC Guidelines, Vol. 1, Chapter 8, p. 8.32).
 - These indirect N₂O emissions have already been reported in inventories prior to 2015 (however the categories of N inputs to soils slightly changed with the 2006 IPCC Guidelines).
 - **Indirect N₂O Emissions from Manure Management in CRF table 3.B.b**
 - These indirect emissions result from volatile nitrogen losses that occur during manure collection and storage and which are diffused into the surrounding air. Nitrogen losses begin at the point of excretion in houses and other animal production areas and continue through on-site management in storage and treatment systems. Nitrogen is also lost through runoff and leaching into soils from the solid storage of manure at outdoor areas, in feedlots. This reporting category has not been estimated and reported separately in the CRF tables prior to 2015 and the method is new.
 - **Indirect N₂O emissions from managed soils in CRF table 4(IV)**
 - Table 3.D.(b) covers indirect N₂O emissions from atmospheric deposition and leaching and run-off from agricultural land areas which includes cropland and grassland areas. Table 4(IV) covers atmospheric deposition and leaching and runoff of N from those land use categories that are not part of agriculture (forest lands, wetlands, settlements, other). This table also covers N mineralization associated with loss of soil organic matter resulting from change of land use or management on mineral soils in all land use categories except for cropland remaining cropland.



Footnote 1 of table 4(IV) explains that if the sources of nitrogen (N) cannot be separated between cropland and grasslands and other land use categories, all indirect N₂O emissions should be included in the agriculture sector and reported in table 3.D.(b). This reporting table was not included in the CRF prior to 2015.

IPCC 2006 Guidelines

- **Indirect N₂O emissions from sources other than agriculture and LULUCF**
 - Guidance is provided in Volume 1 of 2006 IPCC Guidelines, chapter 7, section 7.3 on estimating N₂O emissions from atmospheric deposition resulting from all categories except agricultural soil management and manure management. Section 7.3 provides information on NO_x emissions. Countries may use national methodologies to estimate emissions of NH₃ not originating from agriculture. NH₃ emissions are also covered in the EMEP/CORINAIR Emission Inventory Guidebook.
- **Indirect N₂O emissions from managed soils**
 - IPCC Guidance is provided in Volume 4 of 2006 IPCC Guidelines, Chapter 11, section 11.2.2 indirect N₂O emissions. The methodology addresses indirect N₂O emissions from managed soils arising from agricultural inputs of N from the following sources:
 - synthetic N fertilisers;
 - organic N applied as fertiliser (e.g., applied animal manure, compost, sewage sludge, rendering waste and other organic amendments);
 - urine and dung N deposited on pasture, range and paddock by grazing animals;
 - N in crop residues (above- and below-ground), including N-fixing crops and forage/pasture renewal returned to soils (FCR); and
 - N mineralisation associated with loss of soil organic matter resulting from change of land use or
 - management on mineral soils.
- **Indirect N₂O emissions from manure management:**
 - IPCC Guidance for volatilization is provided in Volume 4 of 2006 IPCC Guidelines, chapter 10, section 10.5.1 in equations 10.26 and 10.27. The Tier 1 calculation of N volatilisation in forms of NH₃ and NO_x from manure management systems is based on multiplication of the amount of nitrogen excreted (from all livestock categories) and managed in each manure management system by a fraction of volatilised nitrogen (see Equation 10.26).
 - IPCC Guidance for leaching is provided in Volume 4 of 2006 IPCC Guidelines, chapter 10, section 10.5.1 in equations 10.28 and 10.29. For the percent of managed manure nitrogen loss due to runoff and leaching during solid and liquid storage of manure (Frac_{leachMS}) which is a key parameter for the indirect N₂O emissions from leaching from manure management systems no clear value is provided in the 2006 IPCC Guidelines, but only a range from 1-20%. Thus, when countries do not have a country-specific value for this parameter, it may be difficult to calculate the indirect N₂O emissions from leaching from manure management. However, 11 MS have nevertheless provided estimates for indirect emissions from leaching from manure management, but other MS have not estimated emissions from leaching due to the lack of this default parameter (see Table 3).
 - Pasture losses are considered separately in Chapter 11, Section 11.2, N₂O Emissions from Managed Soils, as are emissions of nitrogen compounds from grazing livestock and are not part of the emissions in this source category.



- **Indirect N₂O emissions from wastewater**

- The 2006 IPCC Guidelines, Volume 5, also address indirect N₂O emissions which occur from wastewater treatment effluent after this effluent is discharged into waterways, lakes or the sea.
- The nitrogen in the effluent discharged to aquatic environments is calculated according to the methodology in the 2006 IPCC Guidelines as provided in equation 6.7 of Volume 5, chapter 6 and equation 6.8 where the nitrogen in the effluent is calculated based on the annual per capita protein consumption and multiplied with an EF. This calculation is basically the same as in 1996 IPCC Guidelines for N₂O emissions from human sewage, but with some refinements in the calculation with regard to the addition of non-consumed protein added to the wastewater as well as the addition of industrial and commercial co-discharged protein and the subtraction of N removed with sludge.
- The use of 'indirect' N₂O emissions for these wastewater emissions has not been considered when paragraph 29 of the UNFCCC reporting guidelines was drafted that refers to 'indirect N₂O emissions from other than the agriculture and LULUCF sources'. When this para was drafted, experts had in mind the IPCC guidance provided in Volume 1 of the 2006 IPCC Guidelines, chapter 7.3 on atmospheric deposition of nitrogen compounds from NO_x and NH₃ emissions such as fuel combustion, industrial processes. It was not the intention to exclude N₂O emissions from domestic wastewater that have been estimated in the past inventories before 2015 as well (without using the term 'indirect' for these N₂O emissions). The CRF reporting tables for wastewater also don't make a distinction for direct and indirect emissions and it is recommended to report N₂O emissions from human sewage as before 2015 in CRF table 5.D.

1.3 MS reporting in the 2015 submission

Table 3 provides an overview of the reporting of indirect N₂O emissions by Member States.

Table 3 MS reporting of indirect N₂O emissions in 2015 GHG inventories

	Indirect N ₂ O emissions in table 3.B.(b) Manure management		Indirect N ₂ O emissions in table 3.D agricultural soils		Indirect N ₂ O emissions in table 4(IV) managed soils and N mineralization from land use changes		Table 6 indirect N ₂ O emissions
	Atmos. deposition	N leaching and run-off	Atmos. deposition	N leaching and run-off	Atmos. deposition	N leaching and run-off	
AT	0.37	NO	0.47	0.55	NO	NO	NA
BE	0.61	NO	0.58	0.27	IE	IE	NE
BG	0.00	NA	0.67	1.50	NO	NO	2.173 (agriculture, other sectors NO,)
CY	0.16	Blank	0.00	0.01	blank	blank	blank cells



	Indirect N ₂ O emissions in table 3.B.(b) Manure management		Indirect N ₂ O emissions in table 3.D agricultural soils		Indirect N ₂ O emissions in table 4(IV) managed soils and N mineralization from land use changes		Table 6 indirect N ₂ O emissions
	Atmos. deposition	N leaching and run-off	Atmos. deposition	N leaching and run-off	Atmos. deposition	N leaching and run-off	
CZ	0.83	0.50	0.92	1.47	0.02	NO	4.46 (energy, IPPU, agriculture, LULUCF, waste reported)
DE	3.47	NO	5.66	10.37	IE	0.35	NE, NO, NA
DK	0.47	0.00	0.51	1.10	IE, NO	IE, NO	0.78 (energy, IPPU, waste)
ES	NE ⁶	NE	3.01	18.16	NO	NE	NE
EE	0.10	0.00	0.12	0.24	NE	NE	NO
FI	0.30	0.01	0.15	1.13	NO	0.01	0.65 (energy)
FR	4.31	0.98	6.49	10.83	NO	NO	NO
GB	2.37	0.03	4.56	9.15	IE	IE	5.80 (from energy, IPPU, waste)
GR	0.47	0.09	1.13	1.78	NO	NO	NE
HR	0.31	NA	0.31	0.65	IE	IE	NO, NA
HU	0.49	NO	0.56	NO	IE	IE	NE
IE	0.75	NE	0.60	1.06	IE	IE	NE, NO
IT	2.86	IE	2.39	6.14	NO	NE	4.42 (energy, IPPU, LULUCF, waste)
LT	0.28	0.0008	0.41	0.99	IE	IE	NE, NO
LU	0.06	NO	0.06	0.09	NO	NO	NO

⁶ Spain indicated that the estimation of these emissions is currently being assessed by the Inventory Team and planned to be implemented in future editions.



	Indirect N ₂ O emissions in table 3.B.(b) Manure management		Indirect N ₂ O emissions in table 3.D agricultural soils		Indirect N ₂ O emissions in table 4(IV) managed soils and N mineralization from land use changes		Table 6 indirect N ₂ O emissions
	Atmos. deposition	N leaching and run-off	Atmos. deposition	N leaching and run-off	Atmos. deposition	N leaching and run-off	
LV	0.14	0.01	0.19	0.4	IE	0.01	NO, IE
MT	0.01	NE	0.0038	0.01	IE	IE	NE
NL	NO	NO	1.62	1.06	IE	IE	NE, NO
PL	2.93	0.57	2.67	5.97	NO	NO	NA
PT	0.28	0.02	0.39	1.01	IE	IE	NE
RO	1.37	NO	1.15	2.17	NO	NO	4.84 (agriculture)
SK	IE	IE	0.34	1.07	IE	IE	NO, NE
SI	0.09	NO	0.13	0.22	NO	NO	NE
SE	IE	IE	0.58	0.62	NO	NO	0.2 (LULUCF)

- All MS report indirect N₂O emissions from atmospheric deposition and N leaching and run-off in table 3.D for agricultural soils.
- 24 MS provide estimates for indirect N₂O emissions from the atmospheric deposition from manure management, two MS report IE and one MS NO and one NE.
- 11 MS provide estimates for indirect N₂O emissions from leaching and run-off from manure management (3 MS report IE). As explained above no clear default parameter is provided in 2006 IPCC guidelines for the fraction of managed manure nitrogen loss due to runoff and leaching during solid and liquid storage of manure, which explains the lower number of MS providing these emissions.
- Very few MS (only DE, FI, LV) report indirect N₂O emissions in table 4(IV), no MS reports emissions from atmospheric deposition in this table.
- 8 MS report indirect N₂O emissions in table 6.
- Table 6 includes a footnote (2) indicating that Parties may report indirect emissions of N₂O from sources other than agriculture and LULUCF in this table because indirect emissions from these sources are included in agriculture and LULUCF. However, it is possible to report indirect N₂O emissions in table 6 for the sectors agriculture and LULUCF and the corresponding cells are not shaded. 3 MS reported indirect emissions from agricultural sources in this table (BG, CZ and RO) and SE reported indirect N₂O emissions from LULUCF. The NIRs of these countries do not provide clarity



of what is included in table 6 as indirect emissions from agriculture or LULUCF. The 2006 IPCC Guidelines, chapter 7.3 mention that the new guidance on additional indirect N₂O emissions includes atmospheric deposition of N compounds from NO_x and NH₃ sources such as the burning of crop residues and agricultural wastes. This means that there are additional indirect N₂O emissions from agriculture that are not part of the emissions estimated as part of managed soils or manure management. It seems consistent with the approach in the 2006 IPCC Guidelines to exclude those indirect emissions from national totals and report them in table 6 and as memo item, even when the original N source is from agriculture. The distinction made in paragraph 29 of the UNFCCC reporting guidelines mainly had the intention to keep those indirect N₂O emissions part of the national totals that have been included in the inventory since many years, but exclude the additional indirect N₂O sources that have not been previously reported. From this logic, it makes sense to report indirect N₂O emissions also from agricultural sources in table 6 when these sources are not covered by those emissions reported in table 3.D and 3.B.(b).

1.4 Recommendations

- For the agricultural sector, the guidance in the UNFCCC reporting guidelines for GHG inventories seems clear which states that Annex I Parties may report as a memo item only indirect N₂O emissions from other than the agriculture and LULUCF sources. The indirect N₂O emissions from agricultural sources should be included in **CRF tables 3.D. and 3.B.b.** in line with the methodologies explained above.
- Atmospheric deposition and leaching and runoff of N from those land use categories that are not part of agriculture (forest lands, wetlands, settlements, other) should be reported in **Table 4(IV)**.
- If agricultural sources cannot be separated from other land uses in **CRF table 4(IV)** all indirect emissions from managed soils should be reported in table 3.D.(b). If this applies it would be very useful when MS would indicate in the documentation box of table 3.D. that indirect emissions from agriculture and LULUCF sources are reported in this table.
- **Table 6** includes a footnote (2) indicating that Parties may report indirect emissions of N₂O from sources other than agriculture and LULUCF in this table because indirect emissions from these sources are included in agriculture and LULUCF. However, it is possible to report indirect N₂O emissions in table 6 for the sectors agriculture and LULUCF and the corresponding cells are not shaded. The indirect N₂O emissions that are requested in specific tables in the agriculture and LULUCF tables should continue to be reported in the CRF tables 3.B(b), 3.D and 4(IV). Only additional indirect N₂O emissions not covered by the methodologies for these categories should be reported in table 6-. MS should clearly explain which sources are covered in this table in chapter 9 'indirect CO₂ and N₂O emission' in the NIR.
- Indirect N₂O emissions from **wastewater** should continue to be reported in table 5.D as in the years prior to 2015.
- The information provided in chapter 9 'indirect CO₂ and N₂O emission' in the NIR could be improved for some MS, in particular those that report emissions in CRF table 6 should provide information which sources have been estimated.
- It is recommended to discuss which notation keys would be preferable in table 6 as a large variety is currently used for the same underlying situation. If no indirect N₂O emissions are estimated in the energy and IPPU sectors, the notation key 'NE' seems to be appropriate for Table 6 because sources of NO_x and NH₃ do occur in these sectors, however the deposition of these N inputs on lands is mostly not estimated.



Linkages to KP reporting

- Indirect emissions of N₂O from sources other than agriculture and LULUCF should be reported in table 6 and excluded from national totals. As paragraph 29 of the UNFCCC Guidelines are very explicit that these emissions should not be part of the national total, it is recommended to calculate the assigned amount only based on the N₂O emissions that are part of the national total emissions in CRF summary 2 table.



Annex J: Supplementary Info (KP)

Updated: March 2023

J.1 Standard Electronic Format (SEF) tables 2022

Party Portugal
 Submission year 2023
 Reported year 2022
 Commitment period 2

Table 1. Total quantities of Kyoto Protocol units by account type at beginning of reported year

	Account type	Unit type					
		AAUs	ERUs	RMUs	CERs	tCERs	ICERs
1	Party holding accounts	429,581,969	NO	NO	NO	NO	NO
2	Entity holding accounts	NO	NO	NO	NO	NO	NO
3	Retirement account	NO	NO	NO	NO	NO	NO
4	Previous period surplus reserve account	NO					
5	Article 3.3/3.4 net source cancellation accounts	NO	NO	NO	NO		
6	Non-compliance cancellation account	NO	NO	NO	NO		
7	Voluntary cancellation account	NO	NO	NO	NO	NO	NO
8	Cancellation account for remaining units after carry-over	NO	NO	NO	NO	NO	NO
9	Article 3.1 ter and quater ambition increase cancellation account	NO					
10	Article 3.7 ter cancellation account	NO					
11	tCER cancellation account for expiry					NO	
12	ICER cancellation account for expiry						NO
13	ICER cancellation account for reversal of storage						NO
14	ICER cancellation account for non-submission of certification report						NO
15	tCER replacement account for expiry	NO	NO	NO	NO	NO	
16	ICER replacement account for expiry	NO	NO	NO	NO		
17	ICER replacement account for reversal of storage	NO	NO	NO	NO		NO
18	ICER replacement account for non-submission of certification report	NO	NO	NO	NO		NO
	Total	429,581,969	NO	NO	NO	NO	NO



National Inventory Report - Portugal



Party Portugal
 Submission year 2023
 Reported year 2022
 Commitment period 2

Table 2 (a). Annual internal transactions

Transaction type		Additions						Subtractions					
		Unit type						Unit type					
		AAUs	ERUs	RMUs	CERs	tCERs	ICERs	AAUs	ERUs	RMUs	CERs	tCERs	ICERs
Article 6 issuance and conversion													
1	Party-verified projects		NO					NO		NO			
2	Independently verified projects		NO					NO		NO			
Article 3.3 and 3.4 issuance or cancellation													
3	3.3 Afforestation and reforestation			NO				NO	NO	NO	NO		
4	3.3 Deforestation			NO				NO	NO	NO	NO		
5	3.4 Forest management			NO				NO	NO	NO	NO		
6	3.4 Cropland management			NO				NO	NO	NO	NO		
7	3.4 Grazing land management			NO				NO	NO	NO	NO		
8	3.4 Revegetation			NO				NO	NO	NO	NO		
9	3.4 Wetlands drainage and management			NO				NO	NO	NO	NO		
Article 12 afforestation and reforestation													
10	Replacement of expired tCERs							NO	NO	NO	NO	NO	
11	Replacement of expired ICERs							NO	NO	NO	NO		
12	Replacement for reversal of storage							NO	NO	NO	NO		NO
13	Cancellation for reversal of storage												NO
14	Replacement for non-submission of certification report							NO	NO	NO	NO		NO
15	Cancellation for non-submission of certification report												NO
Other cancelation													
16	Voluntary cancellation							NO	NO	NO	NO	NO	NO
17	Article 3.1 ter and quater ambition increase cancellation							NO					
Sub-total			NO	NO				NO	NO	NO	NO	NO	NO

Transaction type		Retirement					
		Unit type					
		AAUs	ERUs	RMUs	CERs	tCERs	ICERs
1	Retirement	NO	NO	NO	NO	NO	NO
2	Retirement from PPSR	NO					
Total		NO	NO	NO	NO	NO	NO



Party Portugal
 Submission year 2023
 Reported year 2022
 Commitment period 2

Table 2 (b). Total annual external transactions

	Additions						Subtractions					
	Unit type						Unit type					
	AAUs	ERUs	RMUs	CERs	tCERs	ICERs	AAUs	ERUs	RMUs	CERs	tCERs	ICERs
Total transfers and acquisitions												
Sub-total	NO	NO	NO	NO	NO	NO	NO	NO	NO	NO	NO	NO

Table 2 (c). Annual transactions between PPSR accounts

	Additions						Subtractions					
	Unit type						Unit type					
	AAUs	ERUs	RMUs	CERs	tCERs	ICERs	AAUs	ERUs	RMUs	CERs	tCERs	ICERs
Transfers and acquisitions between PPSR accounts												
Sub-total	NO						NO					

Table 2 (d). Share of proceeds transactions under decision 1/CMP.8, paragraph 21 - Adaptation fund

	Amount transferred or converted						Amount contributed as SoP to the adaptation fund					
	AAUs	ERUs	RMUs	CERs	tCERs	ICERs	AAUs	ERUs	RMUs	CERs	tCERs	ICERs
1 First international transfers of AAUs	NO						NO					
2 Issuance of ERU from party-verified projects		NO						NO				
3 Issuance of independently verified ERUs		NO						NO				

Table 2 (e). Total annual transactions

1 Total (Sum of sub-totals in table 2a and table 2b)	NO	NO	NO	NO	NO	NO	NO	NO	NO	NO	NO	NO
---	----	----	----	----	----	----	----	----	----	----	----	----



Party Portugal
 Submission year 2023
 Reported year 2022
 Commitment period 2

Table 3. Annual expiry, cancellation and replacement

Transaction or event type		Requirement to replace or cancel			Replacement						Cancellation					
		Unit type			Unit type						Unit type					
		tCERs	ICERs	CERs	AAUs	ERUs	RMUs	CERs	tCERs	ICERs	AAUs	ERUs	RMUs	CERs	tCERs	ICERs
Temporary CERs																
1	Expired in retirement and replacement accounts	NO			NO	NO	NO	NO	NO							
2	Expired in holding accounts	NO												NO		
Long-term CERs																
3	Expired in retirement and replacement accounts		NO		NO	NO	NO	NO								
4	Expired in holding accounts		NO												NO	
5	Subject to reversal of storage		NO		NO	NO	NO	NO		NO					NO	
6	Subject to non-submission of certification Report		NO		NO	NO	NO	NO		NO					NO	
Carbon Capture and Storage CERs																
7	Subject to net reversal of storage			NO							NO	NO	NO	NO		
8	Subject to non-submission of certification report			NO							NO	NO	NO	NO		
Total		NO	NO	NO	NO	NO	NO	NO	NO	NO	NO	NO	NO	NO	NO	



National Inventory Report - Portugal



Party	Portugal
Submission year	2023
Reported year	2022
Commitment period	2

Table 4. Total quantities of Kyoto Protocol units by account type at end of reported year

	Account type	Unit type					
		AAUs	ERUs	RMUs	CERs	tCERs	ICERs
1	Party holding accounts	429,581,969	NO	NO	NO	NO	NO
2	Entity holding accounts	NO	NO	NO	NO	NO	NO
3	Retirement account	NO	NO	NO	NO	NO	NO
4	Previous period surplus reserve account	NO					
5	Article 3.3/3.4 net source cancellation accounts	NO	NO	NO	NO		
6	Non-compliance cancellation account	NO	NO	NO	NO		
7	Voluntary cancellation account	NO	NO	NO	NO	NO	NO
8	Cancellation account for remaining units after carry-over	NO	NO	NO	NO	NO	NO
9	Article 3.1 ter and quater ambition increase cancellation account	NO					
10	Article 3.7 ter cancellation account	NO					
11	tCER cancellation account for expiry					NO	
12	ICER cancellation account for expiry						NO
13	ICER cancellation account for reversal of storage						NO
14	ICER cancellation account for non-submission of certification report						NO
15	tCER replacement account for expiry	NO	NO	NO	NO	NO	
16	ICER replacement account for expiry	NO	NO	NO	NO		
17	ICER replacement account for reversal of storage	NO	NO	NO	NO		NO
18	ICER replacement account for non-submission of certification report	NO	NO	NO	NO		NO
	Total	429,581,969	NO	NO	NO	NO	NO



Party Portugal
 Submission year 2023
 Reported year 2022
 Commitment period 2

Table 5 (a). Summary information on additions and subtractions

		Additions						Subtractions						
		Unit type						Unit type						
		AAUs	ERUs	RMUs	CERs	tCERs	ICERs	AAUs	ERUs	RMUs	CERs	tCERs	ICERs	
1	Assigned amount units issued	429,581,969												
2	Article 3 paragraph 7 ter cancellations							NO						
3	Cancellation following increase in ambition							NO						
4	Cancellation of remaining units after carry over							NO	NO	NO	NO	NO	NO	NO
5	Non-compliance cancellation							NO	NO	NO	NO			
6	Carry-over		NO		NO				NO		NO			
7	Carry-over to PPSR	NO						NO						
	Total	429,581,969	NO		NO			NO	NO	NO	NO	NO	NO	NO

Table 5 (b). Summary information on annual transactions

		Additions						Subtractions						
		Unit type						Unit type						
		AAUs	ERUs	RMUs	CERs	tCERs	ICERs	AAUs	ERUs	RMUs	CERs	tCERs	ICERs	
1	Year 1 (2013)	NO	NO	NO	NO	NO	NO	NO	NO	NO	NO	NO	NO	NO
2	Year 2 (2014)	NO	NO	NO	935,003	NO	NO	NO	NO	NO	NO	NO	NO	NO
3	Year 3 (2015)	NO	NO	NO	1,057,274	NO	NO	NO	NO	NO	935,000	NO	NO	NO
4	Year 4 (2016)	NO	NO	NO	2,346,513	NO	NO	NO	NO	NO	3,403,623	NO	NO	NO
5	Year 5 (2017)	NO	NO	NO	NO	NO	NO	NO	NO	NO	167	NO	NO	NO
6	Year 6 (2018)	NO	NO	NO	NO	NO	NO	NO	NO	NO	NO	NO	NO	NO
7	Year 7 (2019)	NO	NO	NO	NO	NO	NO	NO	NO	NO	NO	NO	NO	NO
8	Year 8 (2020)	NO	NO	NO	NO	NO	NO	NO	NO	NO	NO	NO	NO	NO
9	Year 2021	NO	NO	NO	NO	NO	NO	NO	NO	NO	NO	NO	NO	NO
10	Year 2022	NO	NO	NO	NO	NO	NO	NO	NO	NO	NO	NO	NO	NO
11	Year 2023	NO	NO	NO	NO	NO	NO	NO	NO	NO	NO	NO	NO	NO
	Total	NO	NO	NO	4,338,790	NO	NO	NO	NO	NO	4,338,790	NO	NO	NO



Table 5 (c). Summary information on annual transactions between PPSR accounts

		Additions						Subtractions						
		Unit type						Unit type						
		AAUs	ERUs	RMUs	CERs	tCERs	ICERs	AAUs	ERUs	RMUs	CERs	tCERs	ICERs	
1	Year 1 (2013)	NO						NO						
2	Year 2 (2014)	NO						NO						
3	Year 3 (2015)	NO						NO						
4	Year 4 (2016)	NO						NO						
5	Year 5 (2017)	NO						NO						
6	Year 6 (2018)	NO						NO						
7	Year 7 (2019)	NO						NO						
8	Year 8 (2020)	NO						NO						
9	Year 2021	NO						NO						
10	Year 2022	NO						NO						
11	Year 2023	NO						NO						
	Total	NO						NO						

Table 5 (d). Summary information on expiry, cancellation and replacement

		Requirement to replace or cancel			Replacement						Cancellation					
		Unit type			Unit type						Unit type					
		tCERs	ICERs	CERs	AAUs	ERUs	RMUs	CERs	tCERs	ICERs	AAUs	ERUs	RMUs	CERs	tCERs	ICERs
1	Year 1 (2013)	NO	NO	NO	NO	NO	NO	NO	NO	NO	NO	NO	NO	NO	NO	NO
2	Year 2 (2014)	NO	NO	NO	NO	NO	NO	NO	NO	NO	NO	NO	NO	NO	NO	NO
3	Year 3 (2015)	NO	NO	NO	NO	NO	NO	NO	NO	NO	NO	NO	NO	NO	NO	NO
4	Year 4 (2016)	NO	NO	NO	NO	NO	NO	NO	NO	NO	NO	NO	NO	NO	NO	NO
5	Year 5 (2017)	NO	NO	NO	NO	NO	NO	NO	NO	NO	NO	NO	NO	NO	NO	NO
6	Year 6 (2018)	NO	NO	NO	NO	NO	NO	NO	NO	NO	NO	NO	NO	NO	NO	NO
7	Year 7 (2019)	NO	NO	NO	NO	NO	NO	NO	NO	NO	NO	NO	NO	NO	NO	NO
8	Year 8 (2020)	NO	NO	NO	NO	NO	NO	NO	NO	NO	NO	NO	NO	NO	NO	NO
9	Year 2021	NO	NO	NO	NO	NO	NO	NO	NO	NO	NO	NO	NO	NO	NO	NO
10	Year 2022	NO	NO	NO	NO	NO	NO	NO	NO	NO	NO	NO	NO	NO	NO	NO
11	Year 2023	NO	NO	NO	NO	NO	NO	NO	NO	NO	NO	NO	NO	NO	NO	NO
	Total	NO	NO	NO	NO	NO	NO	NO	NO	NO	NO	NO	NO	NO	NO	NO



Table 5 (e). Summary information on retirement

Year		Retirement					
		Unit type					
		AAUs	ERUs	RMUs	CERs	tCERs	ICERs
1	Year 1 (2013)	NO	NO	NO	NO	NO	NO
2	Year 2 (2014)	NO	NO	NO	NO	NO	NO
3	Year 3 (2015)	NO	NO	NO	NO	NO	NO
4	Year 4 (2016)	NO	NO	NO	NO	NO	NO
5	Year 5 (2017)	NO	NO	NO	NO	NO	NO
6	Year 6 (2018)	NO	NO	NO	NO	NO	NO
7	Year 7 (2019)	NO	NO	NO	NO	NO	NO
8	Year 8 (2020)	NO	NO	NO	NO	NO	NO
9	Year 2021	NO	NO	NO	NO	NO	NO
10	Year 2022	NO	NO	NO	NO	NO	NO
11	Year 2023	NO	NO	NO	NO	NO	NO
	Total	NO	NO	NO	NO	NO	NO



Party Portugal
 Submission year 2023
 Reported year 2022
 Commitment period 2

Table 6 (a). Memo item: Corrective transactions relating to additions and subtractions

	Additions						Subtractions					
	Unit type						Unit type					
	AAUs	ERUs	RMUs	CERs	tCERs	ICERs	AAUs	ERUs	RMUs	CERs	tCERs	ICERs

Table 6 (b). Memo item: Corrective transactions relating to replacement

	Requirement for replacement		Replacement					
	Unit type		Unit type					
	tCERs	ICERs	AAUs	ERUs	RMUs	CERs	tCERs	ICERs

Table 6 (c). Memo item: Corrective transactions relating to retirement

	Retirement					
	Unit type					
	AAUs	ERUs	RMUs	CERs	tCERs	ICERs



J.2 Additional information under Article 7 of the Kyoto Protocol

J.2.1 Information on Accounting Kyoto Units

J.2.1.1 Background information

This section includes supplementary information required under Article 7, paragraph 1, following the reporting requirements of the Annex of Decision 15/CMP.1.

Since the Portuguese registry operates within the Consolidated System of European Union Registries (CSEUR) the SEF reports are based on the data provided by the European Commission.

J.2.1.2 Summary of information reported in the SEF tables

Information on Kyoto Protocol units as reported in the SEF tables for year 2022 is summarized below.

The total number of AAU units in the registry at the end of the year 2022 corresponded to 429,581,969 t CO₂ eq.

At the end of 2022 no CERs, no ERUs, no RMUs, no tCERs, no ICERs were held in any account.

In 2022, the Portuguese registry did not record any external transactions.

In 2022 there were no expiration, cancellation or replacements of units. Furthermore, no corrective transactions relating to additions and subtractions, replacement or retirement occurred.

The total amount of the units in the registry corresponded to 429,581,969 t CO₂ eq. which equals the Portuguese's assigned amount 429,581,969 t CO₂ eq.

J.2.1.3 Discrepancies and notifications

No discrepant transactions, no CDM notifications and no non-replacements occurred in 2021 and no invalid units were registered at the end of 2021. Therefore the relevant reports (R2, R3, R4, R5) are empty.

J.2.1.4 Publicly Accessible Information

Public information is accessible via the Union Registry website at: (<https://unionregistry.ec.europa.eu/euregistry/PT/public/reports/publicReports.xhtml>). This information is updated on a regular basis.

J.2.2 Information on Changes in the National Registry

The following changes to the national registry of Portugal have occurred in 2022. Note that the 2022 SIAR confirms that previous recommendations have been implemented and included in the annual report.



Reporting Item	Description
15/CMP.1 annex II.E paragraph 32.(a) Change of name or contact	There has been no change in the contacts of the National Registry.
15/CMP.1 annex II.E paragraph 32.(b) Change regarding cooperation arrangement	There was a change in the cooperation arrangement during the reported period as the United Kingdom of Great Britain and Northern Ireland no longer operate their registry in a consolidated manner within the Consolidated System of EU registries.
15/CMP.1 annex II.E paragraph 32.(c) Change to database structure or the capacity of national registry	There has been three new EUCR releases (versions 13.6.1, 13.7.1 and 13.8.2) after version 13.5.2 (the production version at the time of the last Chapter 14 submission). No changes were applied to the database, whose model is provided in Annex A. No change was required to the application backup plan or to the disaster recovery plan. No change to the capacity of the national registry occurred during the reported period.
15/CMP.1 annex II.E paragraph 32.(d) Change regarding conformance to technical standards	The changes that have been introduced with versions 13.6.1, 13.7.1 and 13.8.2 compared with version 13.5.2 of the national registry are presented in Annex B. It is to be noted that each release of the registry is subject to both regression testing and tests related to new functionality. These tests also include thorough testing against the DES and are carried out prior to the relevant major release of the version to Production (see Annex B). No other change in the registry's conformance to the technical standards occurred for the reported period.
15/CMP.1 annex II.E paragraph 32.(e) Change to discrepancies procedures	No change of discrepancies procedures occurred during the reported period.
15/CMP.1 annex II.E paragraph 32.(f) Change regarding security	The mandatory use of hardware tokens for authentication and signature was introduced for registry administrators. In 2020, the use of soft tokens for authentication and signature was introduced for the registry end users.
15/CMP.1 annex II.E paragraph 32.(g) Change to list of publicly available information	No change to the list of publicly available information occurred during the reported period. The url with the list of publicly available information is https://unionregistry.ec.europa.eu/euregistry/PT/public/reports/publicReports.xhtml In line with the data protection requirements of Regulation (EC) No 45/2001 and Directive 95/46/EC and in accordance with Article 110 and Annex XIV of Commission Regulation (EU) no 389/2013, the information on account representatives, account holdings, account numbers, all transactions made and unit identifiers, held in the EUTL, the Union Registry and any other KP registry (required by paragraph 45) is considered confidential.
15/CMP.1 annex II.E paragraph 32.(h) Change of Internet address	There has been no change of the internet address of the Registry during the reporting period.
15/CMP.1 annex II.E paragraph 32.(i) Change regarding data integrity measures	No change of data integrity measures occurred during the reported period.
15/CMP.1 annex II.E paragraph 32.(j) Change regarding test results	No change during the reported period.
The previous Annual Review recommendations	The previous annual review reports for 2021 and 2022 are not available for Portugal (https://unfccc.int/process-and-meetings/transparency-and-reporting/reporting-and-review-under-the-convention/greenhouse-gas-inventories-annex-i-parties/inventory-review-reports-2022). There were no previous annual review recommendations in FCCC/ARR/2020/PRT, available at https://unfccc.int/sites/default/files/resource/arr2020_PRT.pdf .